

## Specifications

- Current rating: 2A AC, DC
- Voltage rating: 100V AC, DC
- Temperature range: -40°C ~ +105°C
- Contact resistance: 10mΩ Max.
- Insulation resistance: 1000MΩ Min.
- Withstanding voltage: 800V AC/minute
- \*Compliant with RoHS and REACH\*
- \*Meet the HF/Halogen Free, need to customize\*
- \*Contact CJT for details\*

## Standards

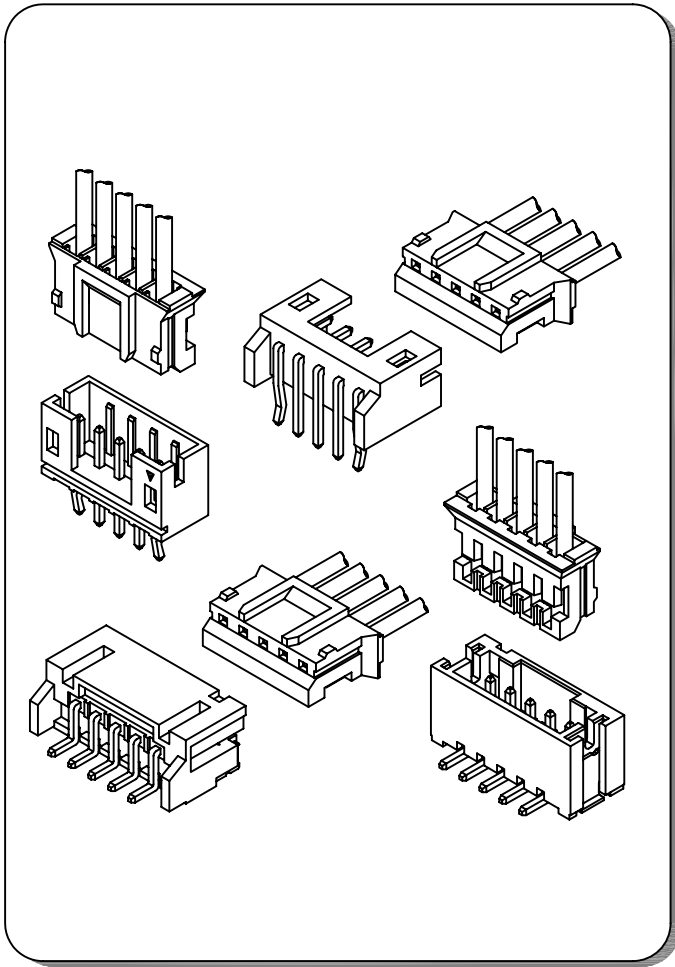

## Assembly layout

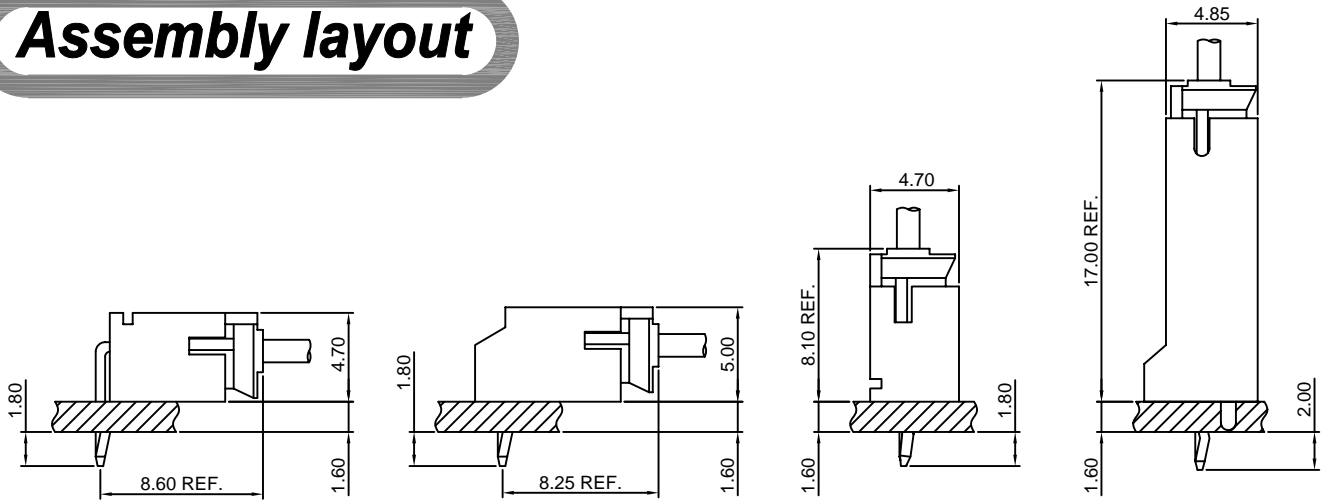

DIP TYPE

SMT TYPE

### A2001-T

2.00mm pitch Crimp Terminal

**Reference Informations:**

\*Used in CJT A2001H-XP series Housing

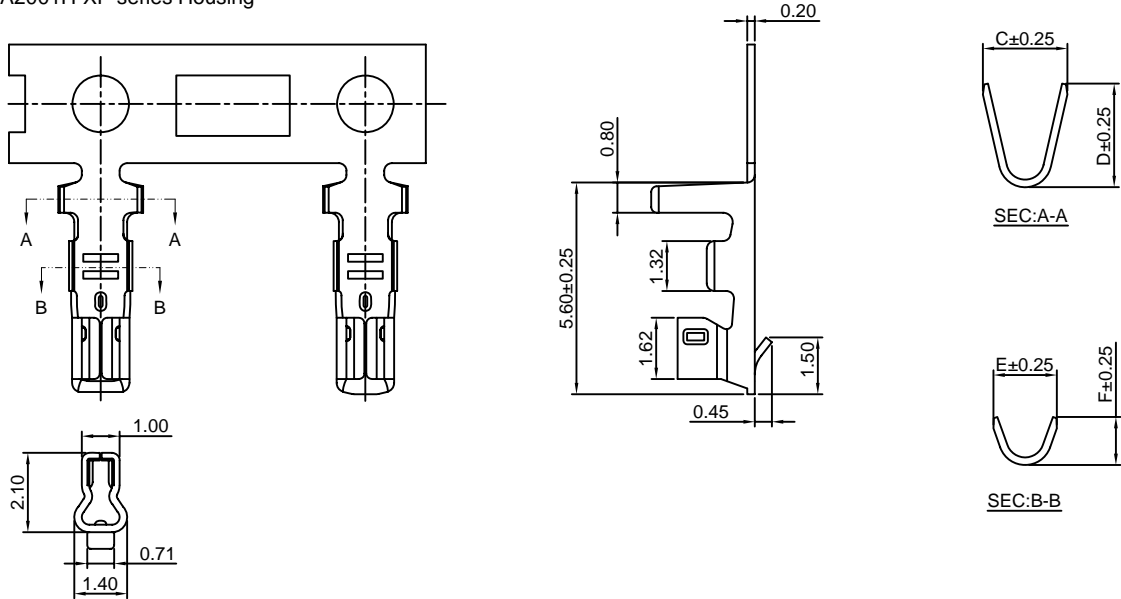

**Ordering information & Specifications:**

Unit:mm

Part NO.	Wire Range	Insulation O.D.	Material	Finish	C	D	E	F	Qty/reel
A2001-TP	AWG#24-#30	1.50mm(max)	Phosphor Bronze	Tin over Nickel	2.20	2.50	1.70	1.40	10,000 PCS
A2001-GP	AWG#24-#30	1.50mm(max)	Phosphor Bronze	Gold over Nickel	2.20	2.50	1.70	1.40	10,000 PCS
A2001-TP-L	AWG#28-#32	0.90mm(max)	Phosphor Bronze	Tin over Nickel	1.55	2.10	1.15	1.15	15,000 PCS
A2001-GP-L	AWG#28-#32	0.90mm(max)	Phosphor Bronze	Gold over Nickel	1.55	2.10	1.15	1.15	15,000 PCS

Optional Gold plating available but MOQ requested

### A2001M-T

2.00mm pitch Crimp Terminal

**Reference Informations:**

\*Used in CJT A2001HM-XP series Housing

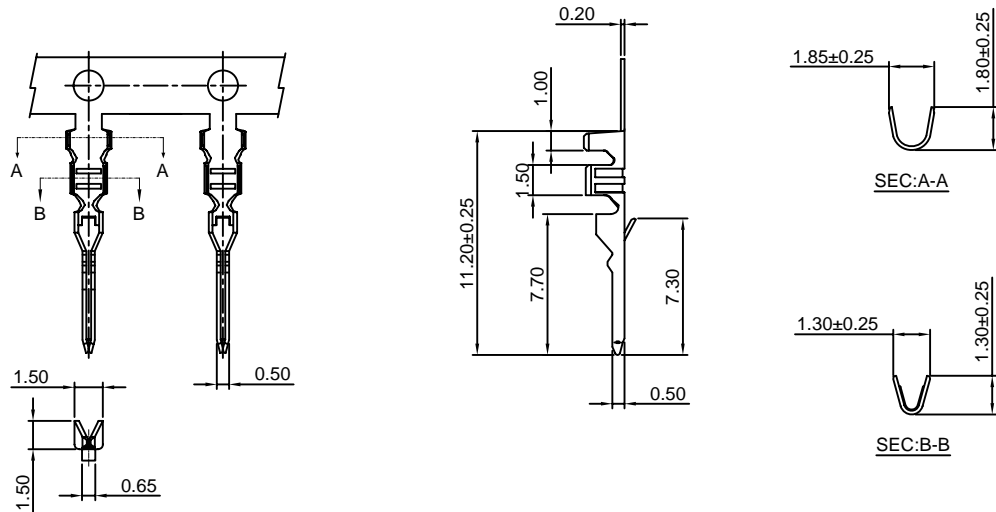

**Ordering information & Specifications:**

Unit:mm

Part NO	Wire Range	Insulation O.D.	Material	Finish	Qty/reel
A2001M-TP	AWG#24-#30	1.50mm(max)	Phosphor Bronze	Tin over Nickel	10,000 PCS
A2001M-TB	AWG#24-#30	1.50mm(max)	Brass	Tin over Nickel	10,000 PCS
A2001M-GP	AWG#24-#30	1.50mm(max)	Phosphor Bronze	Gold over Nickel	10,000 PCS
A2001M-GB	AWG#24-#30	1.50mm(max)	Brass	Gold over Nickel	10,000 PCS

Optional Gold plating available but MOQ requested

### A2001H-XP

2.00mm pitch Housing

**Reference Informations:**

- \*Material:Nylon 66,UL94V-0
- \*Suitable CJT A2001-T(-L) series Terminal
- \*Mates with CJT A2001HM-XP series Housing or A2001WV,WR-XP,A2001WV-S,WR-S-XP series Wafer
- \*Color:White

**Ordering Information:**

- A2001H-XP - \*\*\* - \*\*  
 1                    2                    3
- Part No.
  - Material:  
 (Blank):Nylon 66,UL94V-0  
 GWT:Nylon 66,UL94V-0,GWT 750 °C
  - Color:  
 (Blank):White  
 RD:Red                    OR:Orange  
 YL:Yellow                GY:Gray  
 BL:Blue                    PK:Pink  
 BK:Black                   BR:Brown  
 GN:Green                VI:Violet  
 TR:Tomato red        LY:Lemon yellow  
 LE:Light blue        VY:Vivid yellow  
 DPK:Dark pink

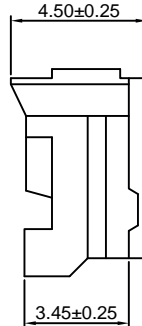
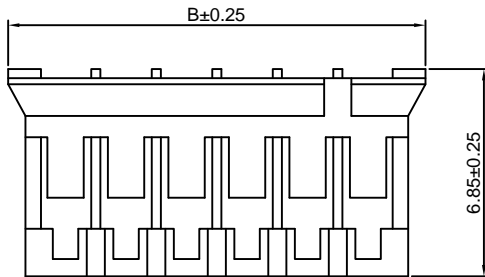
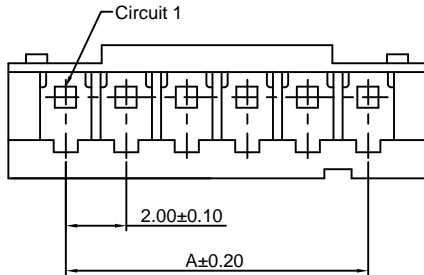
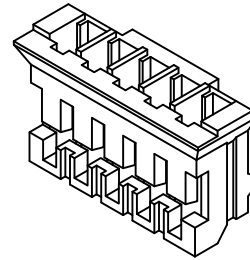

**Ordering Information & Dimensions:**

PART NO.	Dimensions	
	A	B
2P	2.00	5.80
3P	4.00	7.80
4P	6.00	9.80
5P	8.00	11.80
6P	10.00	13.80
7P	12.00	15.80
8P	14.00	17.80
9P	16.00	19.80
10P	18.00	21.80
11P	20.00	23.80
12P	22.00	25.80
13P	24.00	27.80
14P	26.00	29.80
15P	28.00	31.80
16P	30.00	33.80
17P	32.00	35.80
18P	34.00	37.80
19P	36.00	39.80
20P	38.00	41.80

Unit: mm

### A2001HM-XP

2.00mm pitch Housing

**Reference Informations:**

- \*Material:Nylon 66,UL94V-0
- \*Suitable CJT A2001M-T series Terminal
- \*Mates with CJT A2001H-XP series Housing
- \*Color:White

**Ordering Information:**

- A2001HM-XP - \*\*\* - \*\*  
 1                    2                    3
- Part No.
  - Material:  
 (Blank):Nylon 66,UL94V-0  
 GWT:Nylon 66,UL94V-0,GWT 750 °C
  - Color:  
 (Blank):White  
 RD:Red                    OR:Orange  
 YL:Yellow                GY:Gray  
 BL:Blue                    PK:Pink  
 BK:Black                   BR:Brown  
 GN:Green                VI:Violet

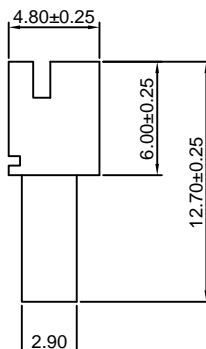
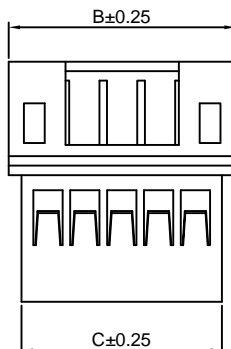
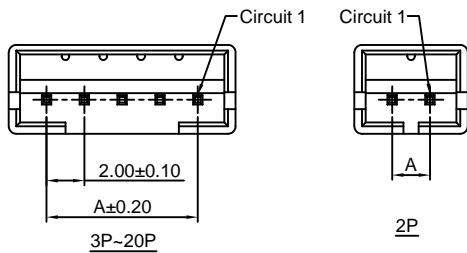

**Ordering Information & Dimensions:**

PART NO.	Dimensions		
	A	B	C
2P	2.00	6.00	4.60
3P	4.00	8.00	6.60
4P	6.00	10.00	8.60
5P	8.00	12.00	10.60
6P	10.00	14.00	12.60
7P	12.00	16.00	14.60
8P	14.00	18.00	16.60
9P	16.00	20.00	18.60
10P	18.00	22.00	20.60
11P	20.00	24.00	22.60
12P	22.00	26.00	24.60
13P	24.00	28.00	26.60
14P	26.00	30.00	28.60
15P	28.00	32.00	30.60
16P	30.00	34.00	32.60
17P	32.00	36.00	34.60
18P	34.00	38.00	36.60
19P	36.00	40.00	38.60
20P	38.00	42.00	40.60

Unit: mm

### A2001WV-XP

2.00mm pitch 180° Wafer

#### Reference Informations:

- \*Material:Pin:Brass/Tin over Nickel  
Insulator:Nylon 66,UL94V-0
- \*Mates with CJT A2001H-XP series Housing
- \*Color:White

#### Ordering Information:

A2001WV-XP - \* - \* - \* - \* - \* - \*

- 1.Part No.
- 2.Style:  
(blank) :Type 1  
2 :Type 2  
3 :Type 3
- 3.Material:  
(Blank):Nylon 66,UL94V-0  
GWT:Nylon 66,UL94V-0,GWT 750 °C
- 4.Color:  
(Blank):White  
RD:Red  
YL:Yellow  
BL:Blue  
BK:Black  
GN:Green  
TR:Tomato red  
LE:Light blue  
(Blank):Tin over Nickel  
G:Gold over Nickel  
OR:Orange  
GY:Gray  
PK:Pink  
BR:Brown  
VI:Violet  
LY:Lemon yellow  
VY:Vivid yellow
- 5.Finish:  
(Blank):Tin over Nickel  
G:Gold over Nickel

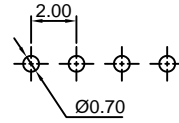
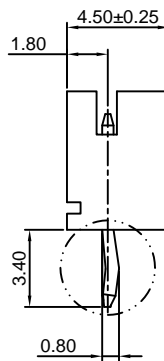
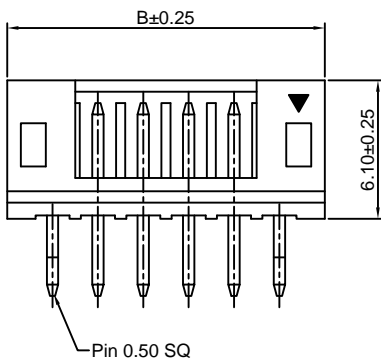
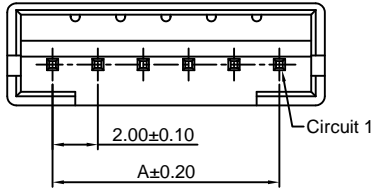

P.C.B LAYOUT

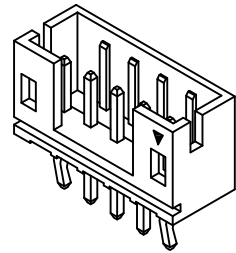

#### Ordering Information & Dimensions:

PART NO.	Dimensions	
	A	B
2P	2.00	6.00
3P	4.00	8.00
4P	6.00	10.00
5P	8.00	12.00
6P	10.00	14.00
7P	12.00	16.00
8P	14.00	18.00
9P	16.00	20.00
10P	18.00	22.00
11P	20.00	24.00
12P	22.00	26.00
13P	24.00	28.00
14P	26.00	30.00
15P	28.00	32.00
16P	30.00	34.00
17P	32.00	36.00
18P	34.00	38.00
19P	36.00	40.00
20P	38.00	42.00

Unit: mm

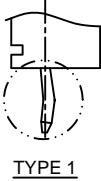

TYPE 1

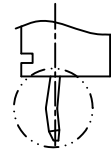

TYPE 2

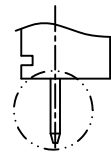

TYPE 3

### A2001WR-XP

2.00mm pitch 90° Wafer

#### Reference Informations:

- \*Material:Pin:Brass/Tin over Nickel  
Insulator:Nylon 66,UL94V-0
- \*Mates with CJT A2001H-XP series Housing
- \*Color:White

#### Ordering Information:

A2001WR-XP - \* - \* - \* - \* - \* - \*

- 1.Part No.
- 2.Style:  
(blank) :Type 1  
2 :Type 2
- 3.Material:  
(Blank):Nylon 66,UL94V-0  
GWT:Nylon 66,UL94V-0,GWT 750 °C
- 4.Color:  
(Blank):White  
RD:Red  
YL:Yellow  
BL:Blue  
BK:Black  
GN:Green  
TR:Tomato red  
LE:Light blue  
(Blank):Tin over Nickel  
G:Gold over Nickel  
OR:Orange  
GY:Gray  
PK:Pink  
BR:Brown  
VI:Violet  
LY:Lemon yellow  
VY:Vivid yellow
- 5.Finish:  
(Blank):Tin over Nickel  
G:Gold over Nickel

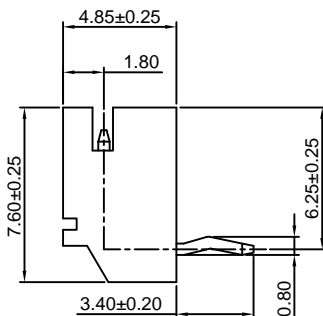
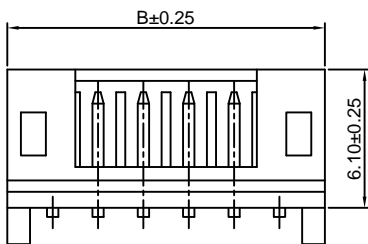
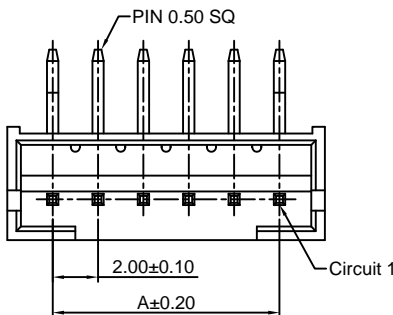

TYPE 1

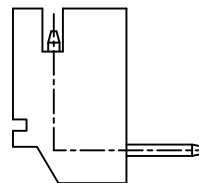

TYPE 2

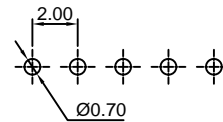

P.C.B LAYOUT

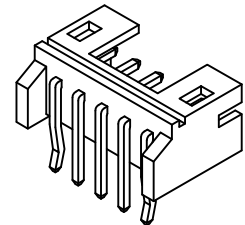

#### Ordering Information & Dimensions:

PART NO.	Dimensions	
	A	B
2P	2.00	6.00
3P	4.00	8.00
4P	6.00	10.00
5P	8.00	12.00
6P	10.00	14.00
7P	12.00	16.00
8P	14.00	18.00
9P	16.00	20.00
10P	18.00	22.00
11P	20.00	24.00
12P	22.00	26.00
13P	24.00	28.00
14P	26.00	30.00
15P	28.00	32.00
16P	30.00	34.00
17P	32.00	36.00
18P	34.00	38.00
19P	36.00	40.00
20P	38.00	42.00

Unit: mm

### A2001WV-S-XP

2.00mm pitch 180° Wafer-SMT TYPE

**Reference Informations:**

- \*Material:Pin:Brass/Tin over Nickel  
Insulator:Nylon 6T,UL94V-0
- \*Mates with CJT A2001H-XP series Housing
- \*Color:Ivory

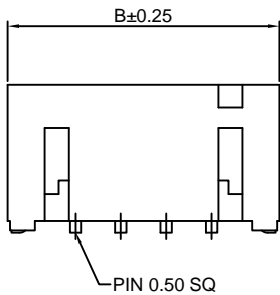
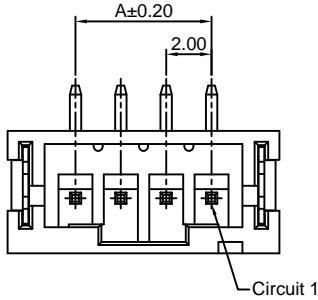

- Ordering Information:  
A2001WV-S-XP - \*\*\* - \*\* - \*\*  
1 2 3 4
- Part No.
  - Material:  
(Blank):Nylon 6T,UL94V-0  
GWT:Nylon 6T,UL94V-0,GWT 750 °C
  - Color:  
(Blank):Ivory  
RD:Red  
BK:Black  
LY:Lemon yellow
  - Finish:  
(Blank):Tin over Nickel  
G:Gold over Nickel

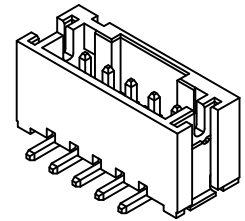
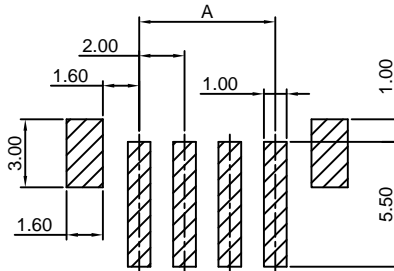

**Ordering Information & Dimensions:**

PART NO.	Dimensions	
	A	B
2P	2.00	8.00
3P	4.00	10.00
4P	6.00	12.00
5P	8.00	14.00
6P	10.00	16.00
7P	12.00	18.00
8P	14.00	20.00
9P	16.00	22.00
10P	18.00	24.00
11P	20.00	26.00
12P	22.00	28.00
13P	24.00	30.00
14P	26.00	32.00
15P	28.00	34.00
16P	30.00	36.00
17P	32.00	38.00
18P	34.00	40.00
19P	36.00	42.00
20P	38.00	44.00

Unit: mm

### A2001WR-S-XP

2.00mm pitch 90° Wafer-SMT TYPE

**Reference Informations:**

- \*Material:Pin:Brass/Tin over Nickel  
Insulator:Nylon 6T,UL94V-0
- \*Mates with CJT A2001H-XP series Housing
- \*Color:Ivory

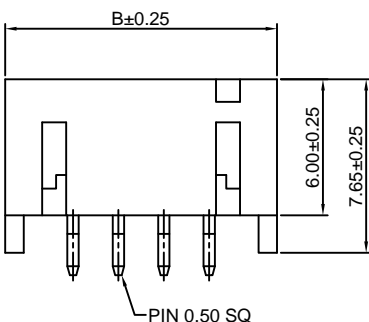
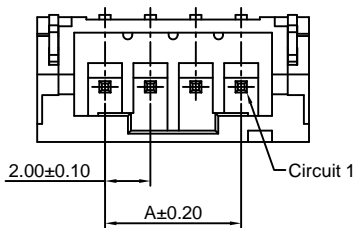

- Ordering Information:  
A2001WR-S-XP - \*\*\* - \*\* - \*\*  
1 2 3 4
- Part No.
  - Material:  
(Blank):Nylon 6T,UL94V-0  
GWT:Nylon 6T,UL94V-0,GWT 750 °C
  - Color:  
(Blank):Ivory  
RD:Red  
BK:Black  
LY:Lemon yellow
  - Finish:  
(Blank):Tin over Nickel  
G:Gold over Nickel

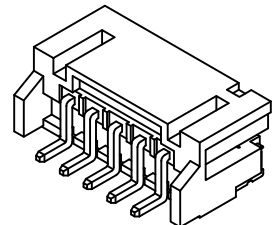
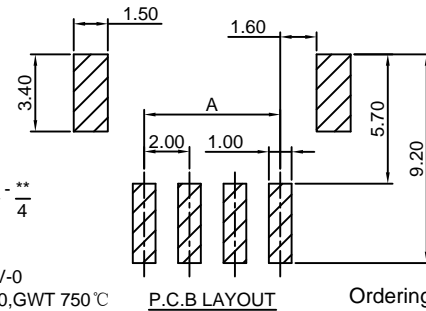

**Ordering Information & Dimensions:**

PART NO.	Dimensions	
	A	B
2P	2.00	8.00
3P	4.00	10.00
4P	6.00	12.00
5P	8.00	14.00
6P	10.00	16.00
7P	12.00	18.00
8P	14.00	20.00
9P	16.00	22.00
10P	18.00	24.00
11P	20.00	26.00
12P	22.00	28.00
13P	24.00	30.00
14P	26.00	32.00
15P	28.00	34.00
16P	30.00	36.00
17P	32.00	38.00
18P	34.00	40.00
19P	36.00	42.00
20P	38.00	44.00

Unit: mm

### A2001WVR-XP

2.00mm pitch 90° Wafer

**Reference Informations:**

- \*Material:Pin:Brass/Tin over Nickel  
Insulator:Nylon 66,UL94V-0
- \*Mates with CJT A2001H-XP series Housing
- \*Color:White

**Ordering Information:**

A2001WVR-XP - \* - \*\* - \*\* - \*\*  
1 2 3 4 5

- 1.Part No.
- 2.Style:  
(blank) :Type 1  
2 :Type 2
- 3.Material:  
(Blank):Nylon 66,UL94V-0  
GWT:Nylon 66,UL94V-0,GWT 750°C
- 4.Color:  
(Blank):White  
RD:Red OR:Orange  
YL:Yellow GY:Gray  
BL:Blue BK:Black  
BK:Black BR:Brown  
GN:Green VI:Violet
- 5.Finish:  
(Blank):Tin over Nickel  
G:Gold over Nickel

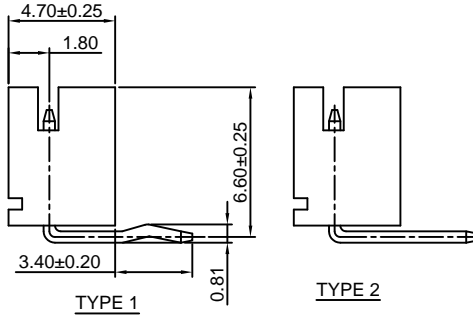
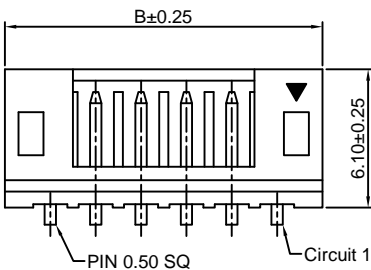
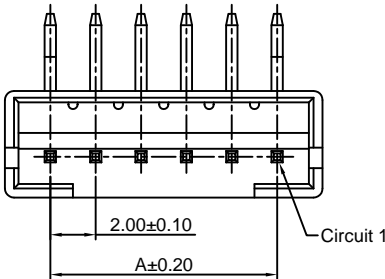
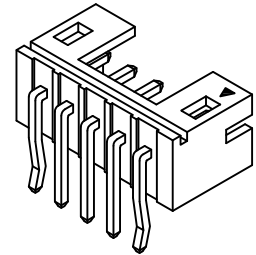
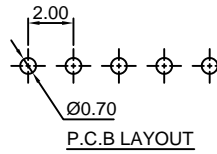

**Ordering Inwithe & Dimensions:**

PART NO.	Dimensions	
	A	B
2P	2.00	6.00
3P	4.00	8.00
4P	6.00	10.00
5P	8.00	12.00
6P	10.00	14.00
7P	12.00	16.00
8P	14.00	18.00
9P	16.00	20.00
10P	18.00	22.00
11P	20.00	24.00
12P	22.00	26.00
13P	24.00	28.00
14P	26.00	30.00
15P	28.00	32.00
16P	30.00	34.00
17P	32.00	36.00
18P	34.00	38.00
19P	36.00	40.00
20P	38.00	42.00

Unit: mm

### A2001WV-F-XP-H

2.00mm pitch 180° Wafer-High box type

**Reference Informations:**

- \*Material:Pin:Brass/Tin over Nickel  
Insulator:Nylon 6T,UL94V-0
- \*Mates with CJT A2001H-XP series Housing
- \*Color:White

**Ordering Information:**

A2001WV-F-XP-H - \*\*\* - \*\* - \*\*  
1 2 3 4

- 1.Part No.
- 2.Material:  
(Blank):Nylon 6T,UL94V-0  
GWT:Nylon 6T,UL94V-0,GWT 750°C
- 3.Color:  
(Blank):White  
RD:Red YL:Yellow  
BL:Blue BK:Black  
BR:Brown GN:Green
- 4.Finish:  
(Blank):Tin over Nickel  
G:Gold over Nickel

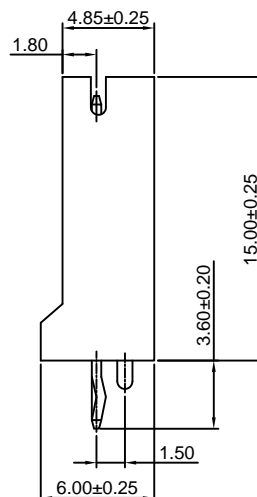
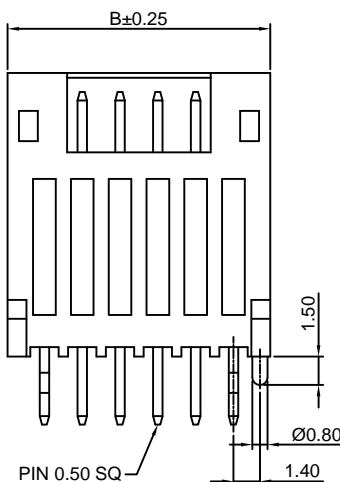
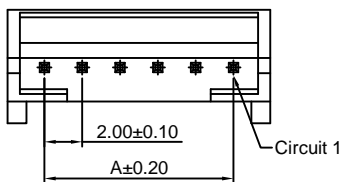
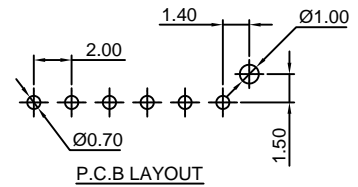

**Ordering Information & Dimensions:**

PART NO.	Dimensions	
	A	B
2P	2.00	6.00
3P	4.00	8.00
4P	6.00	10.00
5P	8.00	12.00
6P	10.00	14.00
7P	12.00	16.00
8P	14.00	18.00
9P	16.00	20.00
10P	18.00	22.00
11P	20.00	24.00
12P	22.00	26.00
13P	24.00	28.00
14P	26.00	30.00
15P	28.00	32.00
16P	30.00	34.00
17P	32.00	36.00
18P	34.00	38.00
19P	36.00	40.00
20P	38.00	42.00

Unit: mm

## X-ON Electronics

Largest Supplier of Electrical and Electronic Components

*Click to view similar products for [Headers & Wire Housings](#) category:*

*Click to view products by [Changjiang](#) manufacturer:*

Other Similar products are found below :

[57102-F02-18ULF](#) [58102-G61-06LF](#) [0009485154](#) [009176003701906](#) [0050291907](#) [00-9021-0611-00-339](#) [02.125.8002.8](#) [609-3404](#) [61062-3](#)  
[622-0430](#) [622-3653LF](#) [63453-116](#) [636-1030](#) [636-1427](#) [636-3427](#) [636-4007](#) [641938-9](#) [644827-2](#) [65495-038](#) [65692-001LF](#) [65781-018](#)  
[65781-047](#) [65817-010LF](#) [65817-015LF](#) [66207-023LF](#) [67016-026LF](#) [67095-007LF](#) [68631-112](#) [68645-018](#) [68648-049](#) [699319-000](#)  
[70.362.1628.0](#) [70-4210](#) [70-4226B](#) [70-4853B](#) [707-5020](#) [707-5028](#) [71.350.2428.0](#) [71961-016LF](#) [733-134](#) [754199-000](#) [760-3052](#) [787-8014-00](#)  
[FCN-367T-T012/H](#) [80.063.4001.1](#) [800-90-001-10-001000](#) [800-90-010-10-002000](#) [801-43-002-10-013000](#) [801-43-006-10-002000](#)  
[803-41-018-10-001000](#)