

## Specifications

- Current rating: 2A AC, DC
- Voltage rating: 100V AC, DC
- Temperature range: -40°C ~ +105°C
- Contact resistance: 10mΩ Max.
- Insulation resistance: 1000MΩ Min.
- Withstanding voltage: 800V AC/minute
- \*Compliant with RoHS and REACH\*
- \*Meet the HF/Halogen Free, need to customize\*
- \*Contact CJT for details\*

## Standards



## Assembly layout

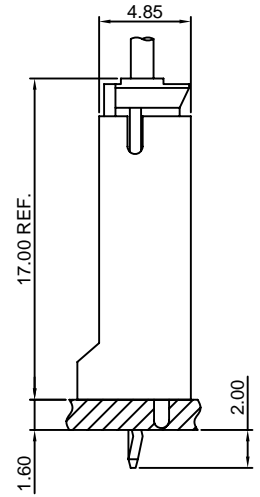
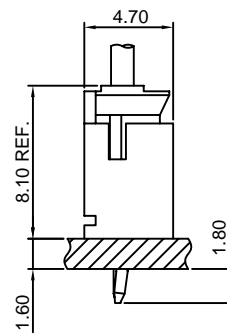
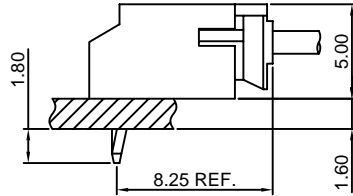
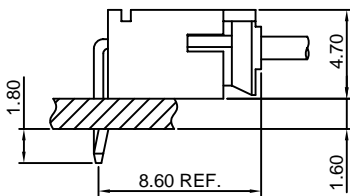

DIP TYPE

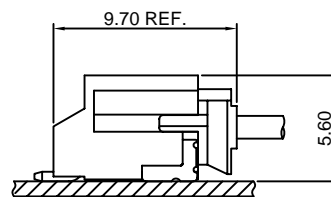
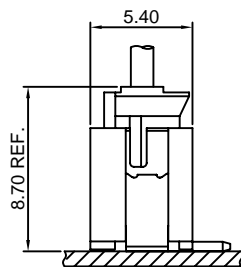

SMT TYPE

### A2001-T

2.00mm pitch Crimp Terminal

**Reference Informations:**

\*Used in CJT [A2001H] series Housing

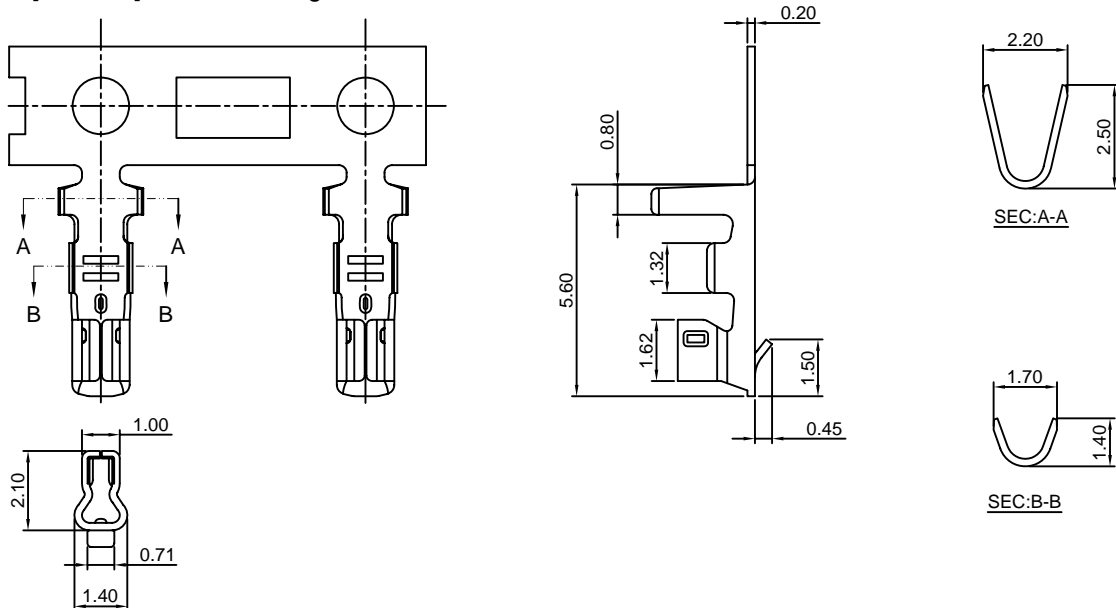

Ordering information & Specifications:

Unit:mm

Part NO	Wire Range	Insulation O.D.	Material	Finish	Qty/reel
A2001-TP	AWG#24-#30	1.50mm(max)	Phosphor Bronze	Tin over Nickel	10,000 PCS
A2001-GP	AWG#24-#30	1.50mm(max)	Phosphor Bronze	Gold over Nickel	10,000 PCS

Optional Gold plating available but MOQ requested

### A2001M-T

2.00mm pitch Crimp Terminal

**Reference Informations:**

\*Used in CJT [A2001HM] series Housing

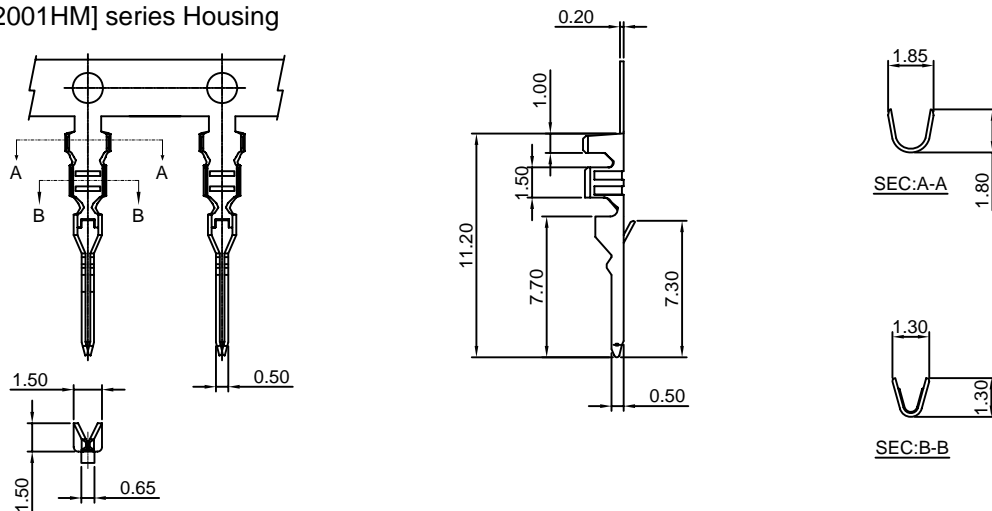

Ordering information & Specifications:

Unit:mm

Part NO	Wire Range	Insulation O.D.	Material	Finish	Qty/reel
A2001M-TP	AWG#24-#30	1.50mm(max)	Phosphor Bronze	Tin over Nickel	10,000 PCS
A2001M-TB	AWG#24-#30	1.50mm(max)	Brass	Tin over Nickel	10,000 PCS
A2001M-GP	AWG#24-#30	1.50mm(max)	Phosphor Bronze	Gold over Nickel	10,000 PCS
A2001M-GB	AWG#24-#30	1.50mm(max)	Brass	Gold over Nickel	10,000 PCS

Optional Gold plating available but MOQ requested

### A2001H

2.00mm pitch Housing

#### Reference Informations:

- \*Material:Nylon 66,UL94V-0
- \*Suitable CJT [A2001-T] series Terminal
- \*Mates with CJT [A2001WV,A2001WR,A2001WV-S,A2001WR-S,A2001WVR,A2001WV-F-H] series Wafer
- \*Color:White

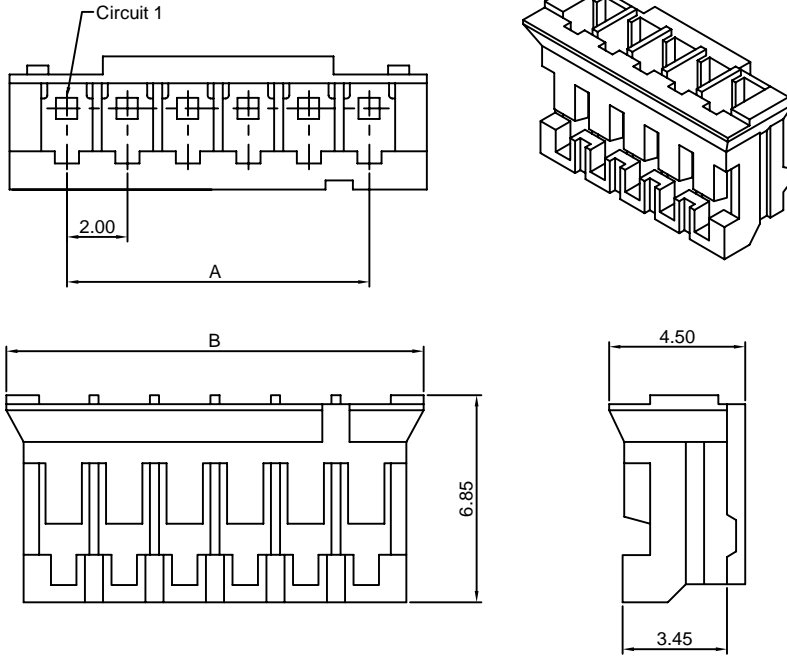

#### Ordering Information & Dimensions:

PART NO.	Dimensions	
	A	B
A2001H-2P	2.00	5.80
A2001H-3P	4.00	7.80
A2001H-4P	6.00	9.80
A2001H-5P	8.00	11.80
A2001H-6P	10.00	13.80
A2001H-7P	12.00	15.80
A2001H-8P	14.00	17.80
A2001H-9P	16.00	19.80
A2001H-10P	18.00	21.80
A2001H-11P	20.00	23.80
A2001H-12P	22.00	25.80
A2001H-13P	24.00	27.80
A2001H-14P	26.00	29.80
A2001H-15P	28.00	31.80
A2001H-16P	30.00	33.80
A2001H-17P	32.00	35.80
A2001H-18P	34.00	37.80
A2001H-19P	36.00	39.80
A2001H-20P	38.00	41.80

Unit: mm

### A2001HM

2.00mm pitch Housing

#### Reference Informations:

- \*Material:Nylon 66,UL94V-0
- \*Suitable CJT [A2001M-T] series Terminal
- \*Color:White

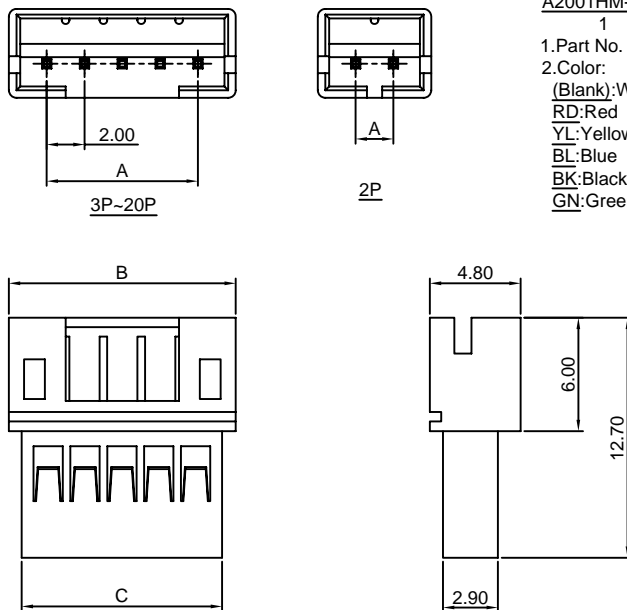

#### Ordering Information:

- A2001HM-XP - \*\*  
1 2
- Part No.
  - Color:  
(Blank):White  
RD:Red  
YL:Yellow  
BL:Blue  
BK:Black  
GN:Green

#### Ordering Information & Dimensions:

PART NO.	Dimensions		
	A	B	C
A2001HM-2P	2.00	6.00	4.60
A2001HM-3P	4.00	8.00	6.60
A2001HM-4P	6.00	10.00	8.60
A2001HM-5P	8.00	12.00	10.60
A2001HM-6P	10.00	14.00	12.60
A2001HM-7P	12.00	16.00	14.60
A2001HM-8P	14.00	18.00	16.60
A2001HM-9P	16.00	20.00	18.60
A2001HM-10P	18.00	22.00	20.60
A2001HM-11P	20.00	24.00	22.60
A2001HM-12P	22.00	26.00	24.60
A2001HM-13P	24.00	28.00	26.60
A2001HM-14P	26.00	30.00	28.60
A2001HM-15P	28.00	32.00	30.60
A2001HM-16P	30.00	34.00	32.60
A2001HM-17P	32.00	36.00	34.60
A2001HM-18P	34.00	38.00	36.60
A2001HM-19P	36.00	40.00	38.60
A2001HM-20P	38.00	42.00	40.60

Unit: mm

### A2001WV

2.00mm pitch 180° Wafer

#### Reference Informations:

- \*Material:Pin:Brass/Tin over Nickel  
Insulator:Nylon 66,UL94V-0
- \*Mates with CJT [A2001H] series Housing
- \*Color:White

Ordering Information:

- A2001WV-XP - \*\*  
1                    2
- 1.Part No.
  - 2.Style:  
(blank) :Type 1  
2 :Type 2  
3 :Type 3

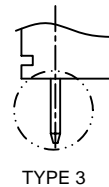
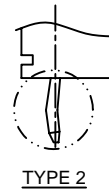
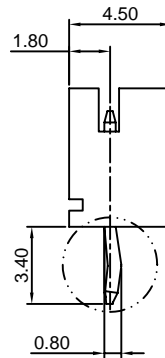
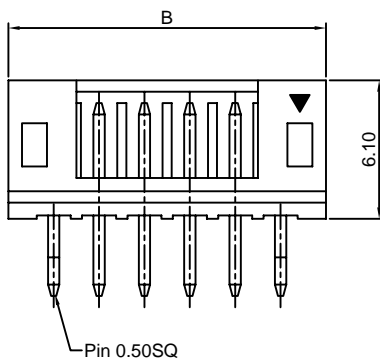
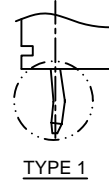
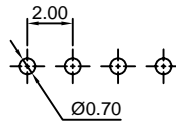
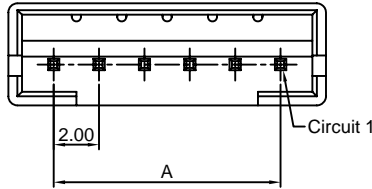
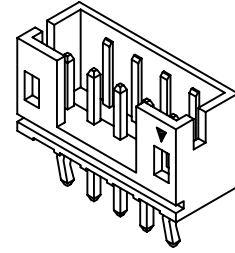

Ordering Information & Dimensions:

PART NO.	Dimensions	
	A	B
A2001WV-2P	2.00	6.00
A2001WV-3P	4.00	8.00
A2001WV-4P	6.00	10.00
A2001WV-5P	8.00	12.00
A2001WV-6P	10.00	14.00
A2001WV-7P	12.00	16.00
A2001WV-8P	14.00	18.00
A2001WV-9P	16.00	20.00
A2001WV-10P	18.00	22.00
A2001WV-11P	20.00	24.00
A2001WV-12P	22.00	26.00
A2001WV-13P	24.00	28.00
A2001WV-14P	26.00	30.00
A2001WV-15P	28.00	32.00
A2001WV-16P	30.00	34.00
A2001WV-17P	32.00	36.00
A2001WV-18P	34.00	38.00
A2001WV-19P	36.00	40.00
A2001WV-20P	38.00	42.00

Unit: mm

### A2001WR

2.00mm pitch 90° Wafer

#### Reference Informations:

- \*Material:Pin:Brass/Tin over Nickel  
Insulator:Nylon 66,UL94V-0
- \*Mates with CJT [A2001H] series Housing
- \*Color:White

Ordering Information:

- A2001WR-XP - \*\*  
1                    2
- 1.Part No.
  - 2.Style:  
(blank) :Type 1  
2 :Type 2

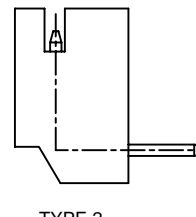
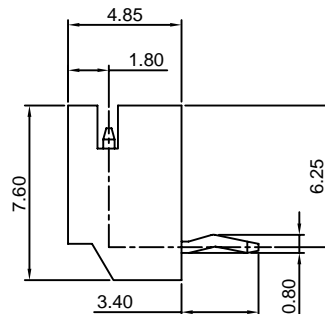
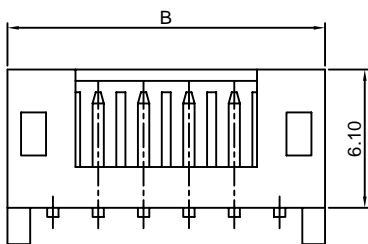
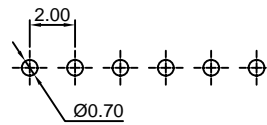
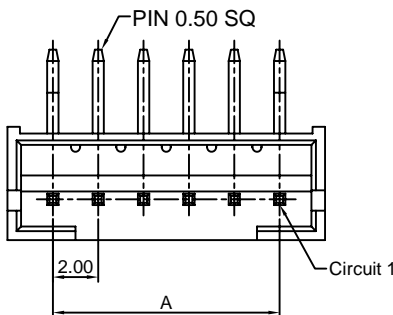
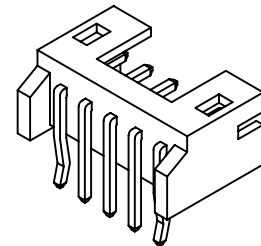

Ordering Information & Dimensions:

PART NO.	Dimensions	
	A	B
A2001WR-2P	2.00	6.00
A2001WR-3P	4.00	8.00
A2001WR-4P	6.00	10.00
A2001WR-5P	8.00	12.00
A2001WR-6P	10.00	14.00
A2001WR-7P	12.00	16.00
A2001WR-8P	14.00	18.00
A2001WR-9P	16.00	20.00
A2001WR-10P	18.00	22.00
A2001WR-11P	20.00	24.00
A2001WR-12P	22.00	26.00
A2001WR-13P	24.00	28.00
A2001WR-14P	26.00	30.00
A2001WR-15P	28.00	32.00
A2001WR-16P	30.00	34.00
A2001WR-17P	32.00	36.00
A2001WR-18P	34.00	38.00
A2001WR-19P	36.00	40.00
A2001WR-20P	38.00	42.00

Unit: mm

### A2001WV-S

2.00mm pitch 180° Wafer-SMT TYPE

**Reference Informations:**

- \*Material:Pin:Brass/Tin over Nickel  
Insulator:Nylon 6T,UL94V-0
- \*Mates with CJT [A2001H] series Housing
- \*Color:Ivory

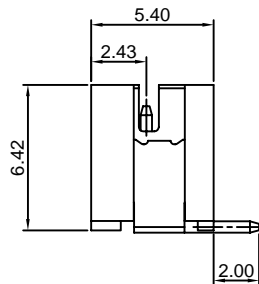
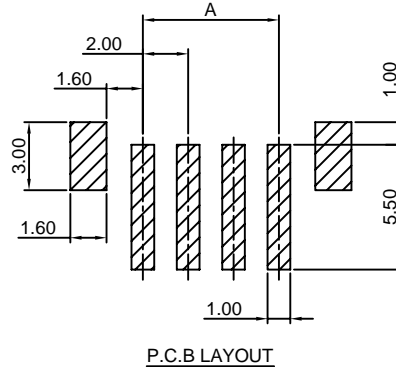
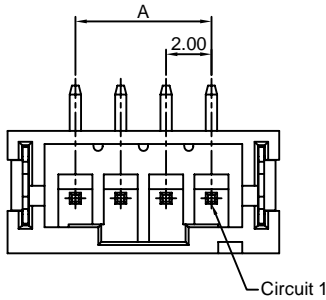

**Ordering Information & Dimensions:**

PART NO.	Dimensions	
	A	B
A2001WV-S-2P	2.00	8.00
A2001WV-S-3P	4.00	10.00
A2001WV-S-4P	6.00	12.00
A2001WV-S-5P	8.00	14.00
A2001WV-S-6P	10.00	16.00
A2001WV-S-7P	12.00	18.00
A2001WV-S-8P	14.00	20.00
A2001WV-S-9P	16.00	22.00
A2001WV-S-10P	18.00	24.00
A2001WV-S-11P	20.00	26.00
A2001WV-S-12P	22.00	28.00
A2001WV-S-13P	24.00	30.00
A2001WV-S-14P	26.00	32.00
A2001WV-S-15P	28.00	34.00
A2001WV-S-16P	30.00	36.00
A2001WV-S-17P	32.00	38.00
A2001WV-S-18P	34.00	40.00
A2001WV-S-19P	36.00	42.00
A2001WV-S-20P	38.00	44.00

Unit: mm

### A2001WR-S

2.00mm pitch 90° Wafer-SMT TYPE

**Reference Informations:**

- \*Material:Pin:Brass/Tin over Nickel  
Insulator:Nylon 6T,UL94V-0
- \*Mates with CJT [A2001H] series Housing
- \*Color:Ivory

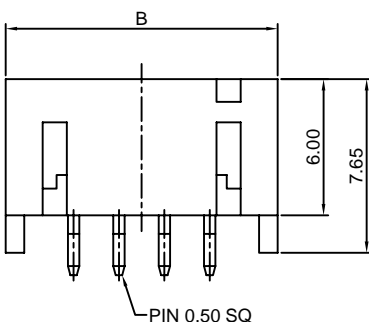
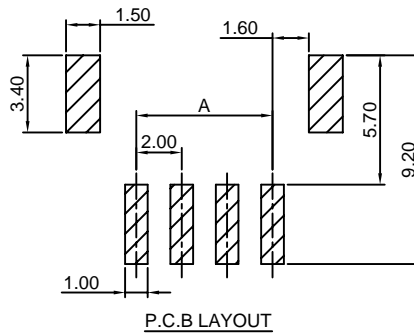
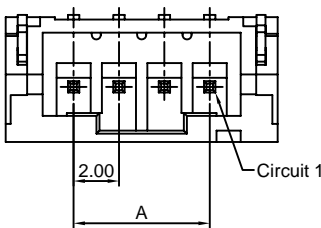

**Ordering Information & Dimensions:**

PART NO.	Dimensions	
	A	B
A2001WR-S-2P	2.00	8.00
A2001WR-S-3P	4.00	10.00
A2001WR-S-4P	6.00	12.00
A2001WR-S-5P	8.00	14.00
A2001WR-S-6P	10.00	16.00
A2001WR-S-7P	12.00	18.00
A2001WR-S-8P	14.00	20.00
A2001WR-S-9P	16.00	22.00
A2001WR-S-10P	18.00	24.00
A2001WR-S-11P	20.00	26.00
A2001WR-S-12P	22.00	28.00
A2001WR-S-13P	24.00	30.00
A2001WR-S-14P	26.00	32.00
A2001WR-S-15P	28.00	34.00
A2001WR-S-16P	30.00	36.00
A2001WR-S-17P	32.00	38.00
A2001WR-S-18P	34.00	40.00
A2001WR-S-19P	36.00	42.00
A2001WR-S-20P	38.00	44.00

Unit: mm

# A2001WVR

2.00mm pitch 90° Wafer

### Reference Informations:

- \*Material: Pin: Brass/Tin over Nickel  
Insulator: Nylon 66, UL94V-0
- \*Mates with CJT [A2001H] series Housing
- \*Color: White

Ordering Information:  
A2001WVR-XP - \*\*

- 1. Part No.
- 2. Style:  
(blank) : Type 1  
2 : Type 2

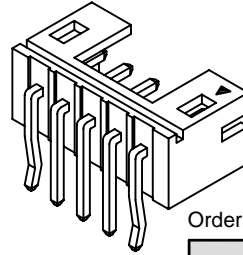

Ordering Information & Dimensions:

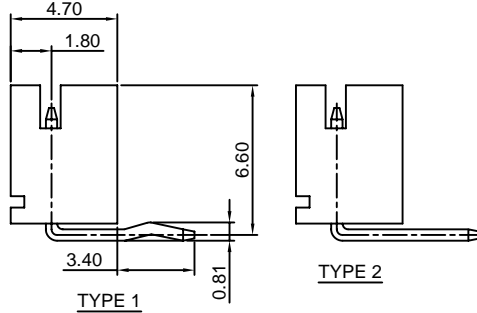
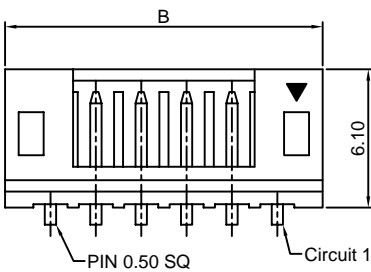
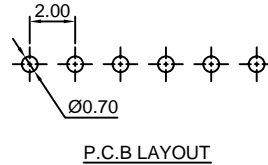
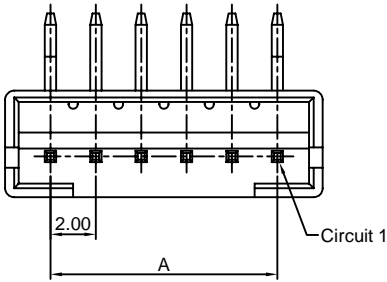

PART NO.	Dimensions	
	A	B
A2001WVR-2P	2.00	6.00
A2001WVR-3P	4.00	8.00
A2001WVR-4P	6.00	10.00
A2001WVR-5P	8.00	12.00
A2001WVR-6P	10.00	14.00
A2001WVR-7P	12.00	16.00
A2001WVR-8P	14.00	18.00
A2001WVR-9P	16.00	20.00
A2001WVR-10P	18.00	22.00
A2001WVR-11P	20.00	24.00
A2001WVR-12P	22.00	26.00
A2001WVR-13P	24.00	28.00
A2001WVR-14P	26.00	30.00
A2001WVR-15P	28.00	32.00
A2001WVR-16P	30.00	34.00
A2001WVR-17P	32.00	36.00
A2001WVR-18P	34.00	38.00
A2001WVR-19P	36.00	40.00
A2001WVR-20P	38.00	42.00

Unit: mm

# A2001WV-F-H

2.00mm pitch 180° Wafer-High box type

### Reference Informations:

- \*Material: Pin: Brass/Tin over Nickel  
Insulator: Nylon 6T, UL94V-0
- \*Mates with CJT [A2001H] series Housing
- \*Color: White

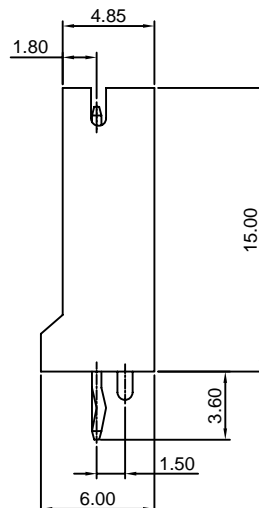
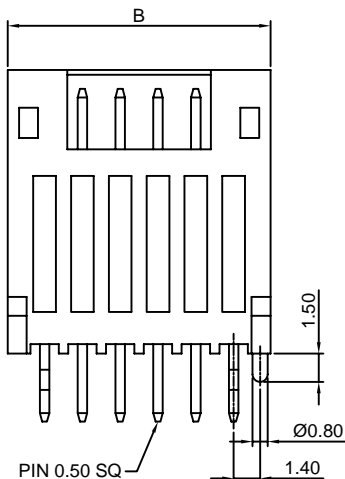
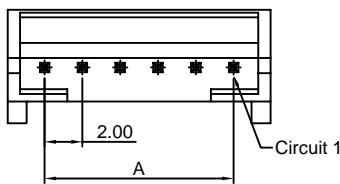
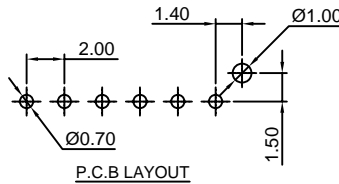

Ordering Information & Dimensions:

PART NO.	Dimensions	
	A	B
A2001WV-F-2P-H	2.00	6.00
A2001WV-F-3P-H	4.00	8.00
A2001WV-F-4P-H	6.00	10.00
A2001WV-F-5P-H	8.00	12.00
A2001WV-F-6P-H	10.00	14.00
A2001WV-F-7P-H	12.00	16.00
A2001WV-F-8P-H	14.00	18.00
A2001WV-F-9P-H	16.00	20.00
A2001WV-F-10P-H	18.00	22.00
A2001WV-F-11P-H	20.00	24.00
A2001WV-F-12P-H	22.00	26.00
A2001WV-F-13P-H	24.00	28.00
A2001WV-F-14P-H	26.00	30.00
A2001WV-F-15P-H	28.00	32.00
A2001WV-F-16P-H	30.00	34.00
A2001WV-F-17P-H	32.00	36.00
A2001WV-F-18P-H	34.00	38.00
A2001WV-F-19P-H	36.00	40.00
A2001WV-F-20P-H	38.00	42.00

Unit: mm

## X-ON Electronics

Largest Supplier of Electrical and Electronic Components

*Click to view similar products for [Headers & Wire Housings](#) category:*

*Click to view products by [Changjiang](#) manufacturer:*

Other Similar products are found below :

[57102-F02-18ULF](#) [58102-G61-06LF](#) [0009485154](#) [009176003701906](#) [0050291907](#) [00-9021-0611-00-339](#) [02.125.8002.8](#) [609-3404](#) [61062-3](#)  
[622-0430](#) [622-3653LF](#) [63453-116](#) [636-1030](#) [636-1427](#) [636-3427](#) [636-4007](#) [641938-9](#) [644827-2](#) [65495-038](#) [65692-001LF](#) [65781-018](#)  
[65781-047](#) [65817-010LF](#) [65817-015LF](#) [66207-023LF](#) [67016-026LF](#) [67095-007LF](#) [68631-112](#) [68645-018](#) [68648-049](#) [699319-000](#)  
[70.362.1628.0](#) [70-4210](#) [70-4226B](#) [70-4853B](#) [707-5020](#) [707-5028](#) [71.350.2428.0](#) [71961-016LF](#) [733-134](#) [754199-000](#) [760-3052](#) [787-8014-00](#)  
[FCN-367T-T012/H](#) [80.063.4001.1](#) [800-90-001-10-001000](#) [800-90-010-10-002000](#) [801-43-002-10-013000](#) [801-43-006-10-002000](#)  
[803-41-018-10-001000](#)