

Specifications

Current rating:2A AC,DC
Voltage rating:125V AC,DC
Temperature range:-40°C~+105°C
Contact resistance:20mΩMax.
Insulation resistance:1000MΩMin.
Withstanding voltage:800V AC/minute
Compliant with RoHS and REACH
Meet the HF/Halogen Free,need to customize
Contact CJT for details

Standards



Assembly layout

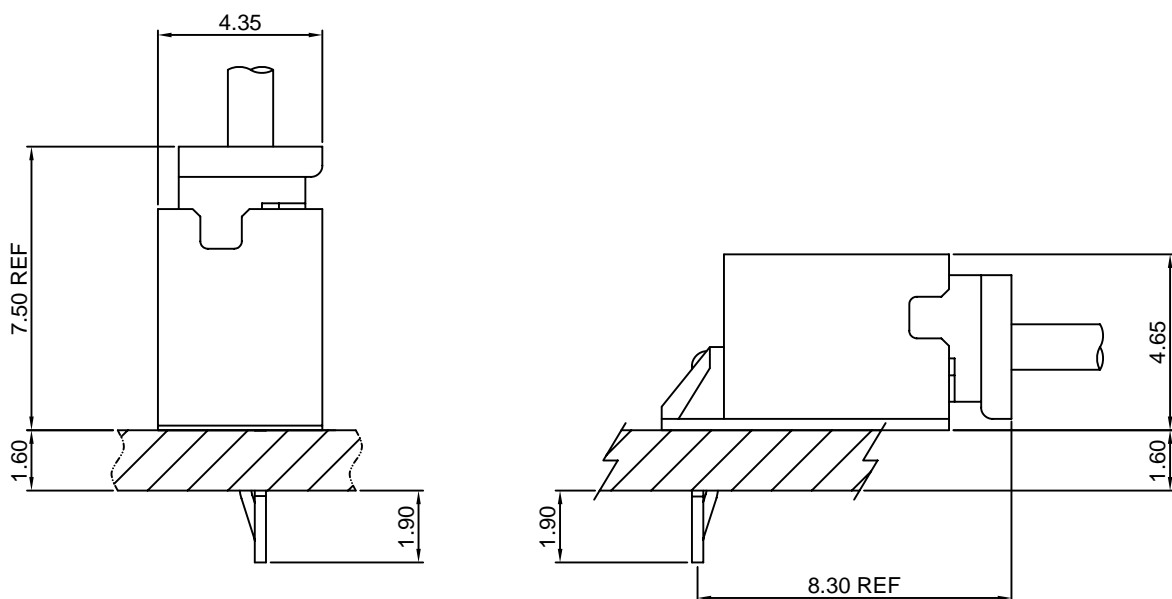

A2004-T

2.00mm pitch Crimp Terminal

Reference Informations:

*Used in CJT A2004H-XP series Housing

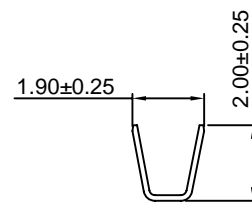
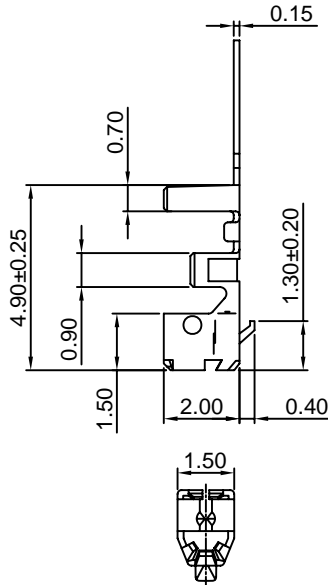
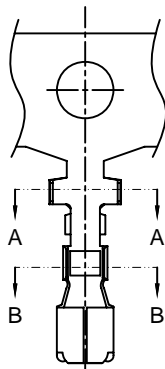

SEC:A-A

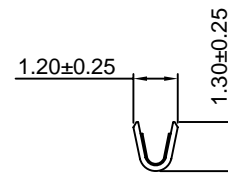

SEC:B-B

Ordering information & Specifications:

Unit:mm

Part NO.	Wire Range	Insulation O.D.	Material	Finish	Qty/reel
A2004-TP	AWG#24-#28	1.40mm(max)	Phosphor Bronze	Tin over Nickel	10,000 PCS
A2004-GP	AWG#24-#28	1.40mm(max)	Phosphor Bronze	Gold over Nickel	10,000 PCS

Optional Gold plating available but MOQ requested

A2004H-XP

2.00mm pitch Housing

Reference Informations:

*Material:Nylon 66,UL94V-0

*Suitable CJT A2004-T series Terminal

*Mates with CJT A2004WV,WR-XP series Wafer

*Color:White

Ordering Information:

A2004H-XP - ***
1 2

1.Part No.

2.Material:

(Blank):Nylon 66,UL94V-0

GWT :Nylon 66,UL94V-0 GWT 750℃

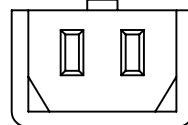
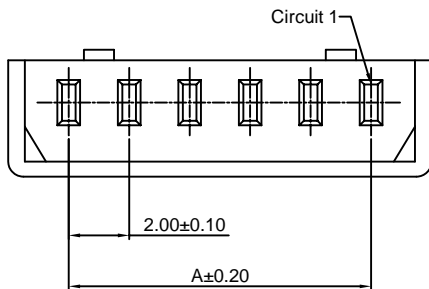
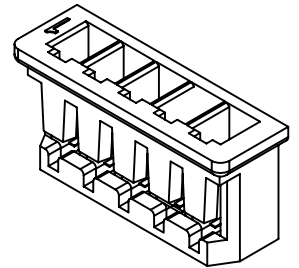

2P

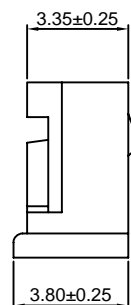
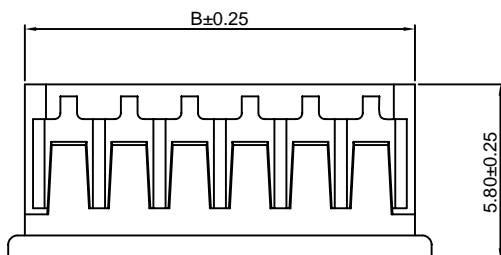

Ordering Information & Dimensions:

PART NO.	Dimensions	
	A	B
2P	2.00	5.90
3P	4.00	7.90
4P	6.00	9.90
5P	8.00	11.90
6P	10.00	13.90
7P	12.00	15.90
8P	14.00	17.90
9P	16.00	19.90
10P	18.00	21.90
11P	20.00	23.90
12P	22.00	25.90
13P	24.00	27.90
14P	26.00	29.90
15P	28.00	31.90

Unit: mm

A2004WV-XP

2.00mm pitch 180° Wafer

Reference Informations:

- *Material:Pin:Phosphor Bronze/Tin over Nickel
Insulator:Nylon 66,UL94V-0
- *Mates with CJT A2004H-XP series Housing
- *Color:Ivory

Ordering Information:

- A2004WV-XP - ***
1 2
- 1.Part No.
 - 2.Material:
(Blank):Nylon 66,UL94V-0
GWT :Nylon 66,UL94V-0 GWT 750 °C

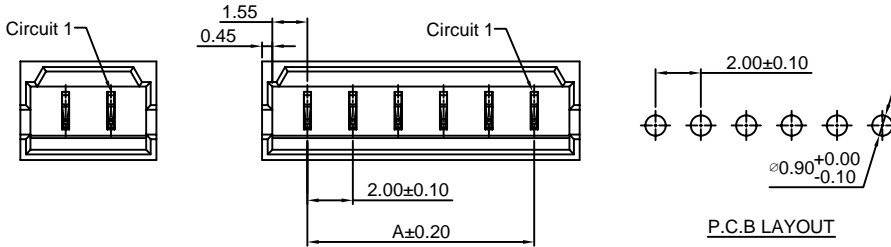
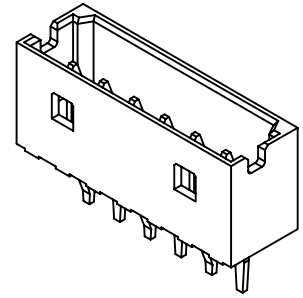

Ordering Information & Dimensions:

PART NO.	Dimensions	
	A	B
2P	2.00	6.00
3P	4.00	8.00
4P	6.00	10.00
5P	8.00	12.00
6P	10.00	14.00
7P	12.00	16.00
8P	14.00	18.00
9P	16.00	20.00
10P	18.00	22.00
11P	20.00	24.00
12P	22.00	26.00
13P	24.00	28.00
14P	26.00	30.00
15P	28.00	32.00

Unit: mm

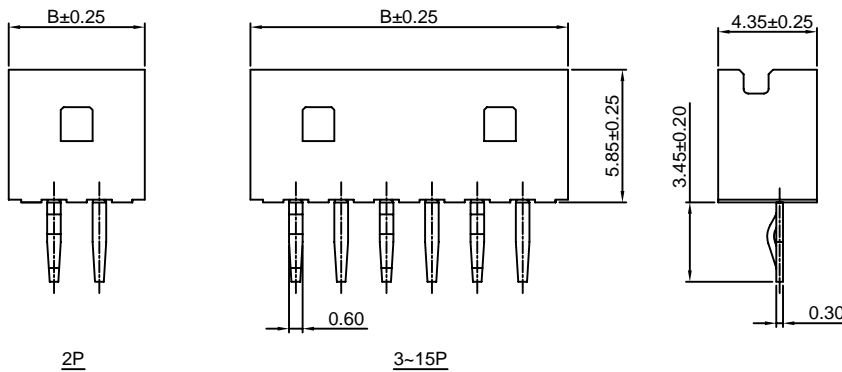

A2004WR-XP

2.00mm pitch 90° Wafer

Reference Informations:

- *Material:Pin:Phosphor Bronze/Tin over Nickel
Insulator:Nylon 66,UL94V-0
- *Mates with CJT A2004H-XP series Housing
- *Color:Ivory

Ordering Information:

- A2004WR-XP - ***
1 2
- 1.Part No.
 - 2.Material:
(Blank):Nylon 66,UL94V-0
GWT :Nylon 66,UL94V-0 GWT 750 °C

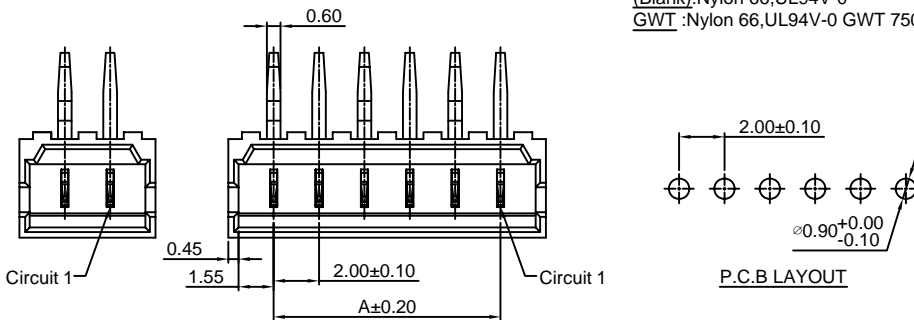
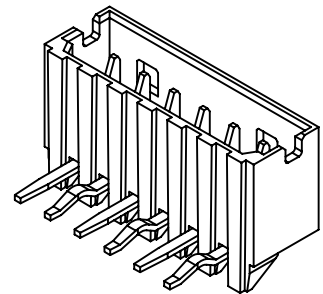

Ordering Information & Dimensions:

PART NO.	Dimensions	
	A	B
2P	2.00	6.00
3P	4.00	8.00
4P	6.00	10.00
5P	8.00	12.00
6P	10.00	14.00
7P	12.00	16.00
8P	14.00	18.00
9P	16.00	20.00
10P	18.00	22.00
11P	20.00	24.00
12P	22.00	26.00
13P	24.00	28.00
14P	26.00	30.00
15P	28.00	32.00

Unit: mm

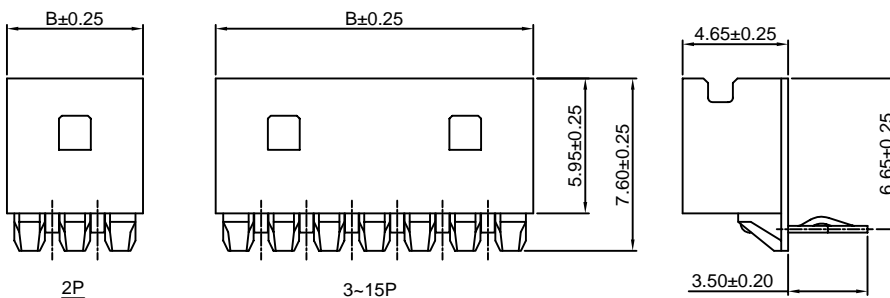

X-ON Electronics

Largest Supplier of Electrical and Electronic Components

Click to view similar products for [Headers & Wire Housings](#) category:

Click to view products by [Changjiang](#) manufacturer:

Other Similar products are found below :

[57102-F02-18ULF](#) [58102-G61-06LF](#) [0009485154](#) [009176003701906](#) [0050291907](#) [02.125.8002.8](#) [609-3404](#) [61062-3](#) [622-0430](#) [622-3653LF](#)
[63453-116](#) [636-1030](#) [636-1427](#) [636-3427](#) [636-4007](#) [641938-9](#) [644827-2](#) [65495-038](#) [65692-001LF](#) [65781-018](#) [65781-047](#) [65817-010LF](#)
[65817-015LF](#) [66207-023LF](#) [67016-026LF](#) [67095-007LF](#) [68631-112](#) [68645-018](#) [68648-049](#) [699319-000](#) [70.362.1628.0](#) [70-4210](#) [70-4226B](#)
[70-4853B](#) [707-5020](#) [707-5028](#) [71.350.2428.0](#) [71961-016LF](#) [733-134](#) [754199-000](#) [760-3052](#) [787-8014-00](#) [FCN-367T-T012/H](#) [80.063.4001.1](#)
[800-90-001-10-001000](#) [800-90-010-10-002000](#) [801-43-002-10-013000](#) [801-43-006-10-002000](#) [803-41-018-10-001000](#) [803-43-014-20-](#)
[001000](#)