

Specifications

- Current rating: 2A AC, DC
- Voltage rating: 250V AC, DC
- Temperature range: -40°C ~ +105°C
- Contact resistance: 20mΩ Max.
- Insulation resistance: 1000MΩ Min.
- Withstanding voltage: 500V AC/minute
- *Compliant with RoHS and REACH*
- *Meet the HF/Halogen Free, need to customize*
- *Contact CJT for details*

Standards



Assembly layout

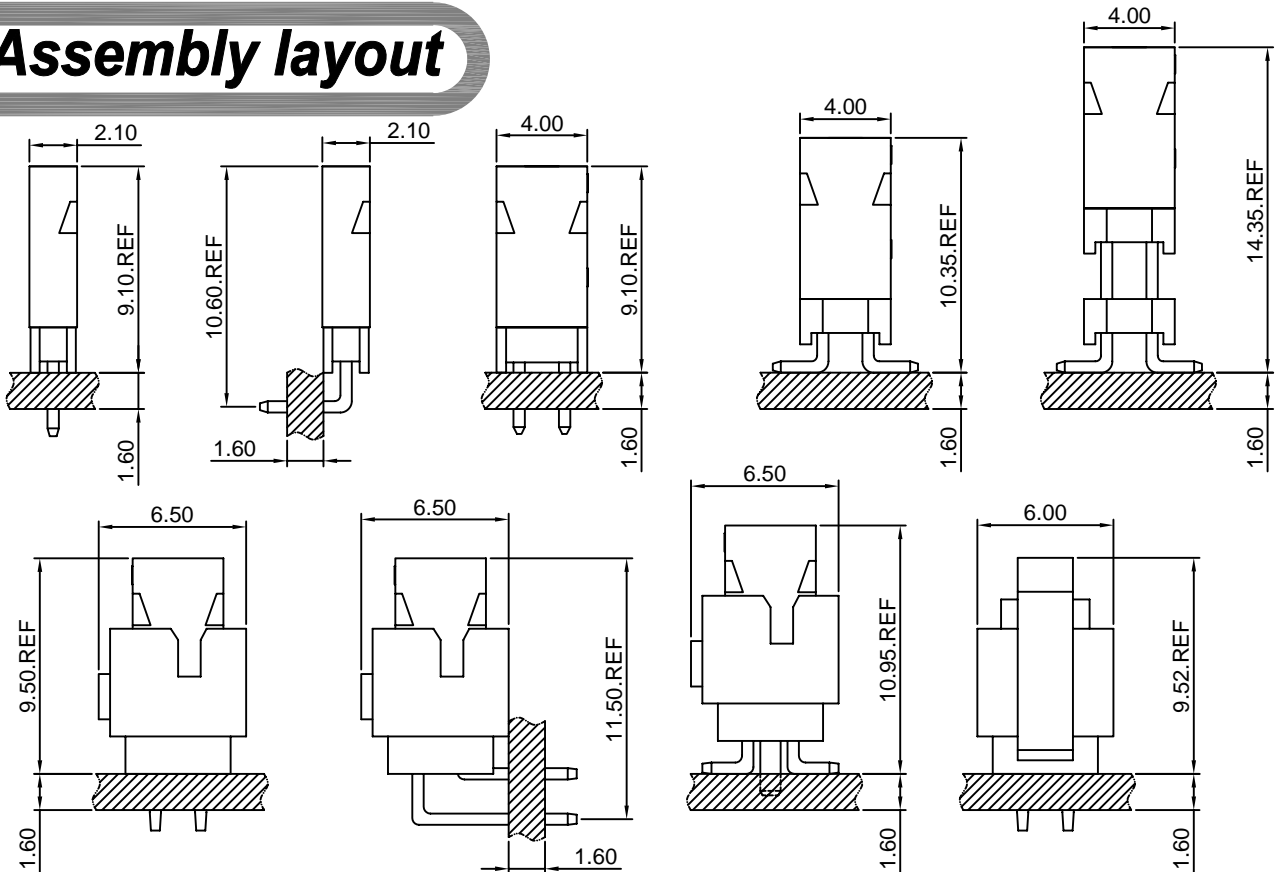

A2005-T

2.00mm pitch Crimp Terminal

Reference Informations:

*Used in CJT A2005 series Housing



Ordering information & Specifications:

Unit:mm

| Part NO. | Wire Range | Insulation O.D. | Material | Finish | Qty/reel |
|----------|------------|-----------------|-----------------|------------------|------------|
| A2005-TP | AWG#26-#30 | 1.40mm(max) | Phosphor Bronze | Tin over Nickel | 10,000 PCS |
| A2005-GP | AWG#26-#30 | 1.40mm(max) | Phosphor Bronze | Gold over Nickel | 10,000 PCS |

Optional Gold plating available but MOQ requested

A2005-T-B

2.00mm pitch Crimp Terminal

Reference Informations:

*Used in CJT A2005 series Housing

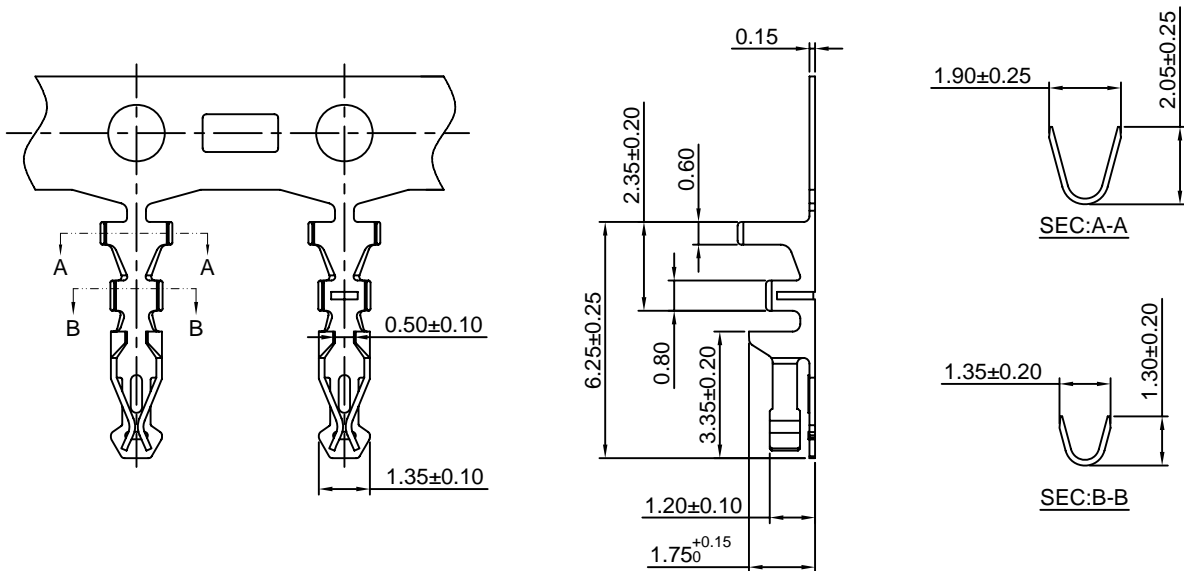

Ordering information & Specifications:

Unit:mm

| Part NO. | Wire Range | Insulation O.D. | Material | Finish | Qty/reel |
|------------|------------|-----------------|-----------------|------------------|------------|
| A2005-GP-B | AWG#24-#30 | 1.40mm(max) | Phosphor Bronze | Gold over Nickel | 10,000 PCS |

A2005H

2.00mm pitch Single Row Housing

Reference Informations:

- *Material:PBT,UL94V-0
- *Suitable CJT A2005 series Terminal
- *Mates with CJT A2005 series Single Row Wafer
- *Color:Black

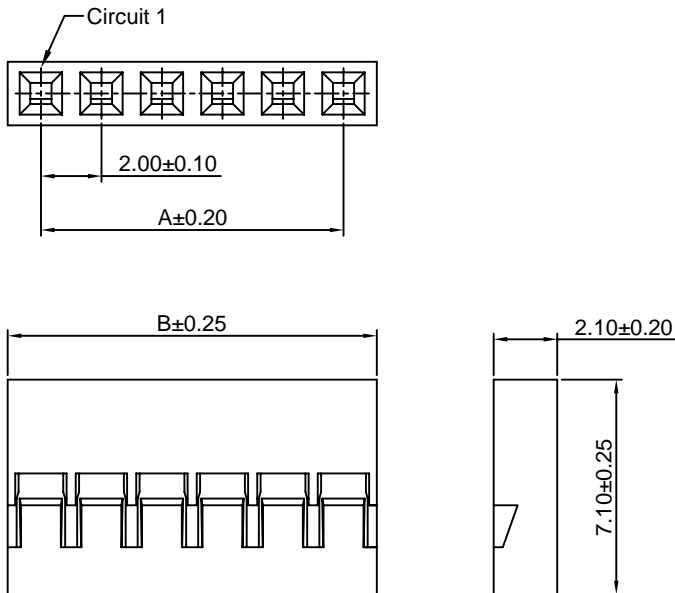
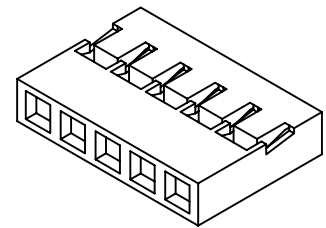

Ordering Information & Dimensions:

| PART NO. | Dimensions | | PART NO. | Dimensions | |
|------------|------------|-------|------------|------------|-------|
| | A | B | | A | B |
| A2005H-2P | 2.00 | 4.20 | A2005H-22P | 42.00 | 44.20 |
| A2005H-3P | 4.00 | 6.20 | A2005H-23P | 44.00 | 46.20 |
| A2005H-4P | 6.00 | 8.20 | A2005H-24P | 46.00 | 48.20 |
| A2005H-5P | 8.00 | 10.20 | A2005H-25P | 48.00 | 50.20 |
| A2005H-6P | 10.00 | 12.20 | A2005H-26P | 50.00 | 52.20 |
| A2005H-7P | 12.00 | 14.20 | A2005H-27P | 52.00 | 54.20 |
| A2005H-8P | 14.00 | 16.20 | A2005H-28P | 54.00 | 56.20 |
| A2005H-9P | 16.00 | 18.20 | A2005H-29P | 56.00 | 58.20 |
| A2005H-10P | 18.00 | 20.20 | A2005H-30P | 58.00 | 60.20 |
| A2005H-11P | 20.00 | 22.20 | A2005H-31P | 60.00 | 62.20 |
| A2005H-12P | 22.00 | 24.20 | A2005H-32P | 62.00 | 64.20 |
| A2005H-13P | 24.00 | 26.20 | A2005H-33P | 64.00 | 66.20 |
| A2005H-14P | 26.00 | 28.20 | A2005H-34P | 66.00 | 68.20 |
| A2005H-15P | 28.00 | 30.20 | A2005H-35P | 68.00 | 70.20 |
| A2005H-16P | 30.00 | 32.20 | A2005H-36P | 70.00 | 72.20 |
| A2005H-17P | 32.00 | 34.20 | A2005H-37P | 72.00 | 74.20 |
| A2005H-18P | 34.00 | 36.20 | A2005H-38P | 74.00 | 76.20 |
| A2005H-19P | 36.00 | 38.20 | A2005H-39P | 76.00 | 78.20 |
| A2005H-20P | 38.00 | 40.20 | A2005H-40P | 78.00 | 80.20 |
| A2005H-21P | 40.00 | 42.20 | | | |

Unit: mm

A2005H-N

2.00mm pitch Single Row Housing

Reference Informations:

- *Material:PBT,UL94V-0
- *Suitable CJT A2005 series Terminal
- *Mates with CJT A2005 series Single Row Wafer
- *Color:Black



Ordering Information & Dimensions:

| PART NO. | Dimensions | | PART NO. | Dimensions | |
|--------------|------------|-------|--------------|------------|-------|
| | A | B | | A | B |
| A2005H-N-2P | 2.00 | 4.20 | A2005H-N-22P | 42.00 | 44.20 |
| A2005H-N-3P | 4.00 | 6.20 | A2005H-N-23P | 44.00 | 46.20 |
| A2005H-N-4P | 6.00 | 8.20 | A2005H-N-24P | 46.00 | 48.20 |
| A2005H-N-5P | 8.00 | 10.20 | A2005H-N-25P | 48.00 | 50.20 |
| A2005H-N-6P | 10.00 | 12.20 | A2005H-N-26P | 50.00 | 52.20 |
| A2005H-N-7P | 12.00 | 14.20 | A2005H-N-27P | 52.00 | 54.20 |
| A2005H-N-8P | 14.00 | 16.20 | A2005H-N-28P | 54.00 | 56.20 |
| A2005H-N-9P | 16.00 | 18.20 | A2005H-N-29P | 56.00 | 58.20 |
| A2005H-N-10P | 18.00 | 20.20 | A2005H-N-30P | 58.00 | 60.20 |
| A2005H-N-11P | 20.00 | 22.20 | A2005H-N-31P | 60.00 | 62.20 |
| A2005H-N-12P | 22.00 | 24.20 | A2005H-N-32P | 62.00 | 64.20 |
| A2005H-N-13P | 24.00 | 26.20 | A2005H-N-33P | 64.00 | 66.20 |
| A2005H-N-14P | 26.00 | 28.20 | A2005H-N-34P | 66.00 | 68.20 |
| A2005H-N-15P | 28.00 | 30.20 | A2005H-N-35P | 68.00 | 70.20 |
| A2005H-N-16P | 30.00 | 32.20 | A2005H-N-36P | 70.00 | 72.20 |
| A2005H-N-17P | 32.00 | 34.20 | A2005H-N-37P | 72.00 | 74.20 |
| A2005H-N-18P | 34.00 | 36.20 | A2005H-N-38P | 74.00 | 76.20 |
| A2005H-N-19P | 36.00 | 38.20 | A2005H-N-39P | 76.00 | 78.20 |
| A2005H-N-20P | 38.00 | 40.20 | A2005H-N-40P | 78.00 | 80.20 |
| A2005H-N-21P | 40.00 | 42.20 | | | |

Unit: mm

A2005HB-N-FI

2.00mm pitch Single Row Housing

Reference Informations:

- *Material:Nylon 66,UL94V-0
- *Suitable CJT A2005 series Terminal
- *Mates with CJT A2005 series Single Row Wafer
- *Color:White

Odering Information:
A2005HB-N-XP-FI - **
 1 2
 1.Part No.
 2.Color:
 (blank) - White
 BK - Black

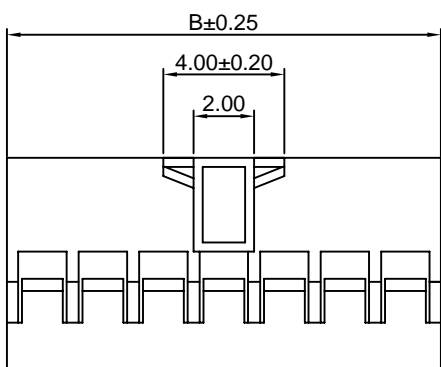
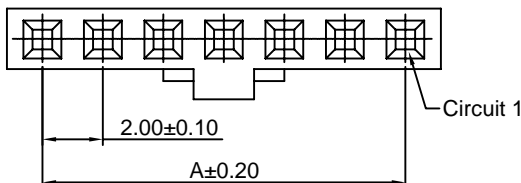
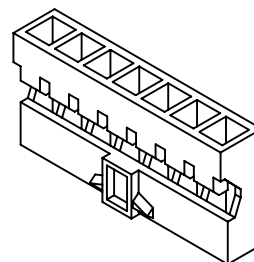

2x3P~2x17P

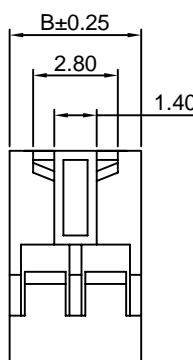
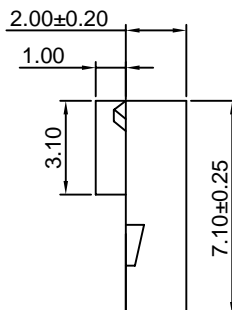

2x2P

Ordering Information & Dimensions:

| PART NO. | Dimensions | |
|------------------|------------|-------|
| | A | B |
| A2005HB-N-2P-FI | 2.00 | 4.35 |
| A2005HB-N-3P-FI | 4.00 | 6.35 |
| A2005HB-N-4P-FI | 6.00 | 8.35 |
| A2005HB-N-5P-FI | 8.00 | 10.35 |
| A2005HB-N-6P-FI | 10.00 | 12.35 |
| A2005HB-N-7P-FI | 12.00 | 14.35 |
| A2005HB-N-8P-FI | 14.00 | 16.35 |
| A2005HB-N-9P-FI | 16.00 | 18.35 |
| A2005HB-N-10P-FI | 18.00 | 20.35 |
| A2005HB-N-11P-FI | 20.00 | 22.35 |
| A2005HB-N-12P-FI | 22.00 | 24.35 |
| A2005HB-N-13P-FI | 24.00 | 26.35 |
| A2005HB-N-14P-FI | 26.00 | 28.35 |
| A2005HB-N-15P-FI | 28.00 | 30.35 |
| A2005HB-N-16P-FI | 30.00 | 32.35 |
| A2005HB-N-17P-FI | 32.00 | 34.35 |

Unit: mm

A2005H-2

2.00mm Pitch Dual Row Housing

Reference Informations:

- *Material:PBT,UL94V-0
- *Suitable CJT A2005 series Terminal
- *Mates with CJT A2005 series Dual Row Wafer
- *Color:Black

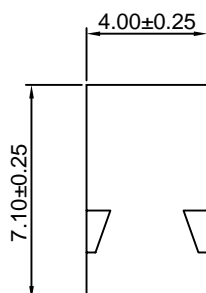
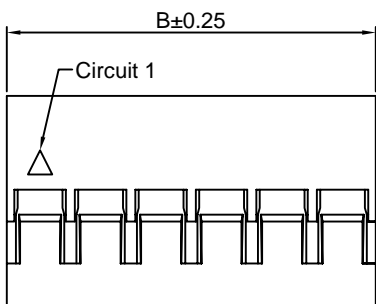
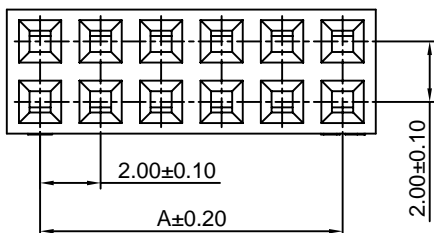
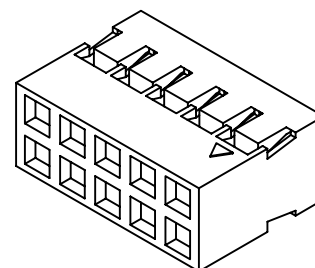

Ordering Information & Dimensions:

| PART NO. | Dimensions | | PART NO. | Dimensions | |
|--------------|------------|-------|--------------|------------|-------|
| | A | B | | A | B |
| A2005H-2x2P | 2.00 | 4.20 | A2005H-2x22P | 42.00 | 44.20 |
| A2005H-2x3P | 4.00 | 6.20 | A2005H-2x23P | 44.00 | 46.20 |
| A2005H-2x4P | 6.00 | 8.20 | A2005H-2x24P | 46.00 | 48.20 |
| A2005H-2x5P | 8.00 | 10.20 | A2005H-2x25P | 48.00 | 50.20 |
| A2005H-2x6P | 10.00 | 12.20 | A2005H-2x26P | 50.00 | 52.20 |
| A2005H-2x7P | 12.00 | 14.20 | A2005H-2x27P | 52.00 | 54.20 |
| A2005H-2x8P | 14.00 | 16.20 | A2005H-2x28P | 54.00 | 56.20 |
| A2005H-2x9P | 16.00 | 18.20 | A2005H-2x29P | 56.00 | 58.20 |
| A2005H-2x10P | 18.00 | 20.20 | A2005H-2x30P | 58.00 | 60.20 |
| A2005H-2x11P | 20.00 | 22.20 | A2005H-2x31P | 60.00 | 62.20 |
| A2005H-2x12P | 22.00 | 24.20 | A2005H-2x32P | 62.00 | 64.20 |
| A2005H-2x13P | 24.00 | 26.20 | A2005H-2x33P | 64.00 | 66.20 |
| A2005H-2x14P | 26.00 | 28.20 | A2005H-2x34P | 66.00 | 68.20 |
| A2005H-2x15P | 28.00 | 30.20 | A2005H-2x35P | 68.00 | 70.20 |
| A2005H-2x16P | 30.00 | 32.20 | A2005H-2x36P | 70.00 | 72.20 |
| A2005H-2x17P | 32.00 | 34.20 | A2005H-2x37P | 72.00 | 74.20 |
| A2005H-2x18P | 34.00 | 36.20 | A2005H-2x38P | 74.00 | 76.20 |
| A2005H-2x19P | 36.00 | 38.20 | A2005H-2x39P | 76.00 | 78.20 |
| A2005H-2x20P | 38.00 | 40.20 | A2005H-2x40P | 78.00 | 80.20 |
| A2005H-2x21P | 40.00 | 42.20 | | | |

Unit: mm

A2005H-N-2-B

2.00mm Pitch Dual Row Housing

Reference Informations:

- *Material:PBT,UL94V-0
- *Suitable CJT A2005 series Terminal
- *Mates with CJT A2005 series Dual Row Wafer
- *Color:Black



Ordering Information & Dimensions:

| PART NO. | Dimensions | | PART NO. | Dimensions | |
|------------------|------------|-------|------------------|------------|-------|
| | A | B | | A | B |
| A2005H-N-2x2P-B | 2.00 | 4.20 | A2005H-N-2x22P-B | 42.00 | 44.20 |
| A2005H-N-2x3P-B | 4.00 | 6.20 | A2005H-N-2x23P-B | 44.00 | 46.20 |
| A2005H-N-2x4P-B | 6.00 | 8.20 | A2005H-N-2x24P-B | 46.00 | 48.20 |
| A2005H-N-2x5P-B | 8.00 | 10.20 | A2005H-N-2x25P-B | 48.00 | 50.20 |
| A2005H-N-2x6P-B | 10.00 | 12.20 | A2005H-N-2x26P-B | 50.00 | 52.20 |
| A2005H-N-2x7P-B | 12.00 | 14.20 | A2005H-N-2x27P-B | 52.00 | 54.20 |
| A2005H-N-2x8P-B | 14.00 | 16.20 | A2005H-N-2x28P-B | 54.00 | 56.20 |
| A2005H-N-2x9P-B | 16.00 | 18.20 | A2005H-N-2x29P-B | 56.00 | 58.20 |
| A2005H-N-2x10P-B | 18.00 | 20.20 | A2005H-N-2x30P-B | 58.00 | 60.20 |
| A2005H-N-2x11P-B | 20.00 | 22.20 | A2005H-N-2x31P-B | 60.00 | 62.20 |
| A2005H-N-2x12P-B | 22.00 | 24.20 | A2005H-N-2x32P-B | 62.00 | 64.20 |
| A2005H-N-2x13P-B | 24.00 | 26.20 | A2005H-N-2x33P-B | 64.00 | 66.20 |
| A2005H-N-2x14P-B | 26.00 | 28.20 | A2005H-N-2x34P-B | 66.00 | 68.20 |
| A2005H-N-2x15P-B | 28.00 | 30.20 | A2005H-N-2x35P-B | 68.00 | 70.20 |
| A2005H-N-2x16P-B | 30.00 | 32.20 | A2005H-N-2x36P-B | 70.00 | 72.20 |
| A2005H-N-2x17P-B | 32.00 | 34.20 | A2005H-N-2x37P-B | 72.00 | 74.20 |
| A2005H-N-2x18P-B | 34.00 | 36.20 | A2005H-N-2x38P-B | 74.00 | 76.20 |
| A2005H-N-2x19P-B | 36.00 | 38.20 | A2005H-N-2x39P-B | 76.00 | 78.20 |
| A2005H-N-2x20P-B | 38.00 | 40.20 | A2005H-N-2x40P-B | 78.00 | 80.20 |
| A2005H-N-2x21P-B | 40.00 | 42.20 | | | |

Unit: mm

A2005HA-2

2.00mm Pitch Dual Row Housing

Reference Informations:

- *Material:Nylon 66,UL94V-0
- *Suitable CJT A2005-B series Terminal
- *Mates with CJT A2005 series Dual Row Wafer
- *Color:Black

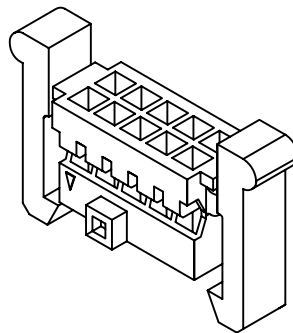

Ordering Information & Dimensions:

| PART NO. | Dimensions | |
|---------------|------------|-------|
| | A | B |
| A2005HA-2x2P | 2.00 | 4.35 |
| A2005HA-2x3P | 4.00 | 6.35 |
| A2005HA-2x4P | 6.00 | 8.35 |
| A2005HA-2x5P | 8.00 | 10.35 |
| A2005HA-2x6P | 10.00 | 12.35 |
| A2005HA-2x7P | 12.00 | 14.35 |
| A2005HA-2x8P | 14.00 | 16.35 |
| A2005HA-2x9P | 16.00 | 18.35 |
| A2005HA-2x10P | 18.00 | 20.35 |
| A2005HA-2x11P | 20.00 | 22.35 |
| A2005HA-2x12P | 22.00 | 24.35 |
| A2005HA-2x13P | 24.00 | 26.35 |
| A2005HA-2x14P | 26.00 | 28.35 |
| A2005HA-2x15P | 28.00 | 30.35 |
| A2005HA-2x16P | 30.00 | 32.35 |
| A2005HA-2x17P | 32.00 | 34.35 |
| A2005HA-2x18P | 34.00 | 36.35 |
| A2005HA-2x19P | 36.00 | 38.35 |
| A2005HA-2x20P | 38.00 | 40.35 |
| A2005HA-2x21P | 40.00 | 42.35 |
| A2005HA-2x22P | 42.00 | 44.35 |
| A2005HA-2x23P | 44.00 | 46.35 |
| A2005HA-2x24P | 46.00 | 48.35 |
| A2005HA-2x25P | 48.00 | 50.35 |

Unit: mm

A2005HB-N-2-B

2.00mm Pitch Dual Row Housing

Reference Informations:

- *Material:Nylon 66,UL94V-0
- *Suitable CJT A2005-B series Terminal
- *Mates with CJT A2005 series Dual Row Wafer
- *Color:Black

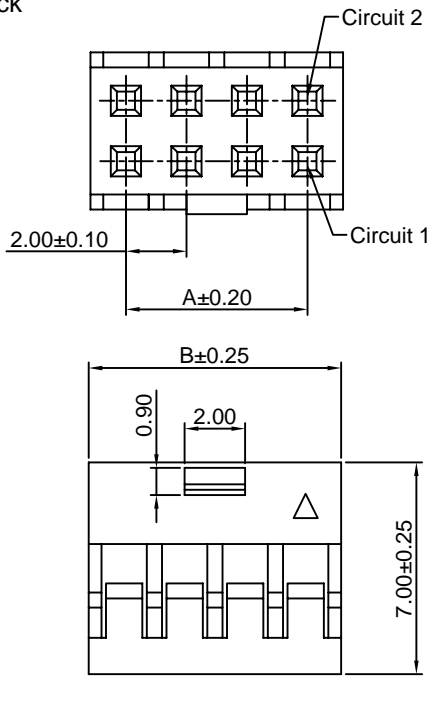
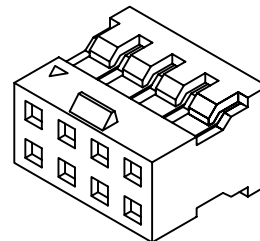

Ordering Information & Dimensions:

| PART NO. | Dimensions | |
|------------------|------------|-------|
| | A | B |
| A2005HB-N-2x2P-B | 2.00 | 4.35 |
| A2005HB-N-2x3P-B | 4.00 | 6.35 |
| A2005HB-N-2x4P-B | 6.00 | 8.35 |
| A2005HB-N-2x5P-B | 8.00 | 10.35 |
| A2005HB-N-2x6P-B | 10.00 | 12.35 |

Unit: mm

A2005HB-N-2-C

2.00mm Pitch Dual Row Housing

Reference Informations:

- *Material:Nylon 66,UL94V-0
- *Suitable CJT A2005-B series Terminal
- *Mates with CJT A2005 series Dual Row Wafer
- *Color:Black

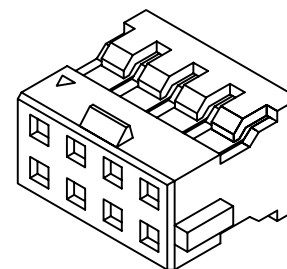

Ordering Information & Dimensions:

| PART NO. | Dimensions | |
|------------------|------------|-------|
| | A | B |
| A2005HB-N-2x2P-C | 2.00 | 4.35 |
| A2005HB-N-2x3P-C | 4.00 | 6.35 |
| A2005HB-N-2x4P-C | 6.00 | 8.35 |
| A2005HB-N-2x5P-C | 8.00 | 10.35 |
| A2005HB-N-2x6P-C | 10.00 | 12.35 |

Unit: mm

A2005HB-N-2-D

2.00mm Pitch Dual Row Housing

Reference Informations:

- *Material:Nylon 66,UL94V-0
- *Suitable CJT A2005-B series Terminal
- *Mates with CJT A2005 series Dual Row Wafer
- *Color:Black

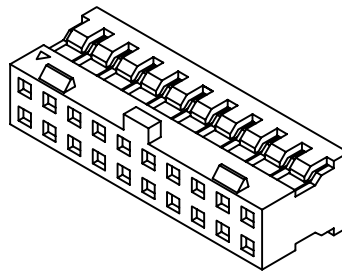

Ordering Information & Dimensions:

| PART NO. | Dimensions | | |
|-------------------|------------|-------|-------|
| | A | B | C |
| A2005HB-N-2x2P-D | 2.00 | 4.35 | --- |
| A2005HB-N-2x3P-D | 4.00 | 6.35 | --- |
| A2005HB-N-2x4P-D | 6.00 | 8.35 | --- |
| A2005HB-N-2x5P-D | 8.00 | 10.35 | --- |
| A2005HB-N-2x6P-D | 10.00 | 12.35 | --- |
| A2005HB-N-2x7P-D | 12.00 | 14.35 | 8.00 |
| A2005HB-N-2x8P-D | 14.00 | 16.35 | 10.00 |
| A2005HB-N-2x9P-D | 16.00 | 18.35 | 12.00 |
| A2005HB-N-2x10P-D | 18.00 | 20.35 | 14.00 |
| A2005HB-N-2x11P-D | 20.00 | 22.35 | 16.00 |
| A2005HB-N-2x12P-D | 22.00 | 24.35 | 18.00 |
| A2005HB-N-2x13P-D | 24.00 | 26.35 | 20.00 |
| A2005HB-N-2x14P-D | 26.00 | 28.35 | 22.00 |
| A2005HB-N-2x15P-D | 28.00 | 30.35 | 24.00 |
| A2005HB-N-2x16P-D | 30.00 | 32.35 | 26.00 |
| A2005HB-N-2x17P-D | 32.00 | 34.35 | 28.00 |
| A2005HB-N-2x18P-D | 34.00 | 36.35 | 30.00 |
| A2005HB-N-2x19P-D | 36.00 | 38.35 | 32.00 |
| A2005HB-N-2x20P-D | 38.00 | 40.35 | 34.00 |
| A2005HB-N-2x21P-D | 40.00 | 42.35 | 36.00 |
| A2005HB-N-2x22P-D | 42.00 | 44.35 | 38.00 |
| A2005HB-N-2x23P-D | 44.00 | 46.35 | 40.00 |
| A2005HB-N-2x24P-D | 46.00 | 48.35 | 42.00 |
| A2005HB-N-2x25P-D | 48.00 | 50.35 | 44.00 |

Unit: mm

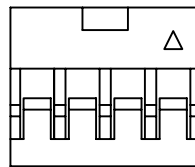
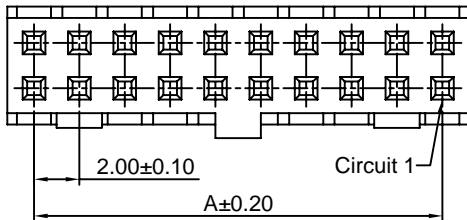

2x2P~2x6P

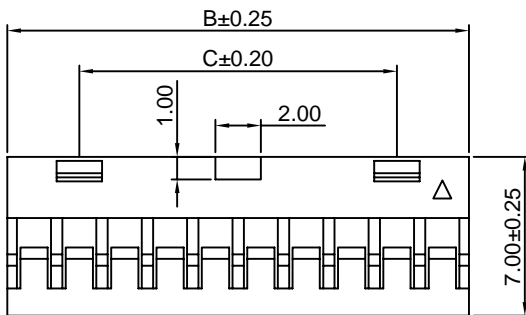

2x7P~2x25P

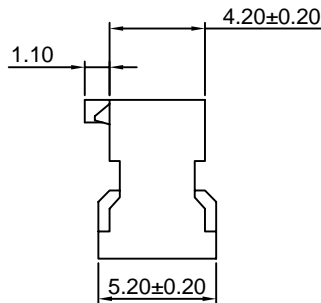

A2005HB-N-2-J

2.00mm Pitch Dual Row Housing

Reference Informations:

- *Material:Nylon 66,UL94V-0
- *Suitable CJT A2005-B series Terminal
- *Mates with CJT A2005 series Dual Row Wafer
- *Color:Black

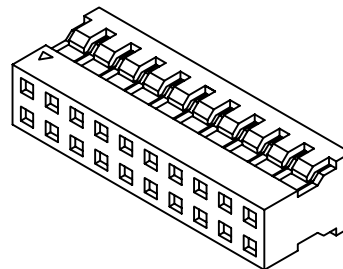

Ordering Information & Dimensions:

| PART NO. | Dimensions | |
|-------------------|------------|-------|
| | A | B |
| A2005HB-N-2x2P-J | 2.00 | 4.35 |
| A2005HB-N-2x3P-J | 4.00 | 6.35 |
| A2005HB-N-2x4P-J | 6.00 | 8.35 |
| A2005HB-N-2x5P-J | 8.00 | 10.35 |
| A2005HB-N-2x6P-J | 10.00 | 12.35 |
| A2005HB-N-2x7P-J | 12.00 | 14.35 |
| A2005HB-N-2x8P-J | 14.00 | 16.35 |
| A2005HB-N-2x9P-J | 16.00 | 18.35 |
| A2005HB-N-2x10P-J | 18.00 | 20.35 |
| A2005HB-N-2x11P-J | 20.00 | 22.35 |
| A2005HB-N-2x12P-J | 22.00 | 24.35 |
| A2005HB-N-2x13P-J | 24.00 | 26.35 |
| A2005HB-N-2x14P-J | 26.00 | 28.35 |
| A2005HB-N-2x15P-J | 28.00 | 30.35 |
| A2005HB-N-2x16P-J | 30.00 | 32.35 |
| A2005HB-N-2x17P-J | 32.00 | 34.35 |
| A2005HB-N-2x18P-J | 34.00 | 36.35 |
| A2005HB-N-2x19P-J | 36.00 | 38.35 |
| A2005HB-N-2x20P-J | 38.00 | 40.35 |
| A2005HB-N-2x21P-J | 40.00 | 42.35 |
| A2005HB-N-2x22P-J | 42.00 | 44.35 |
| A2005HB-N-2x23P-J | 44.00 | 46.35 |
| A2005HB-N-2x24P-J | 46.00 | 48.35 |
| A2005HB-N-2x25P-J | 48.00 | 50.35 |

Unit: mm

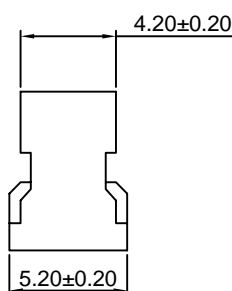
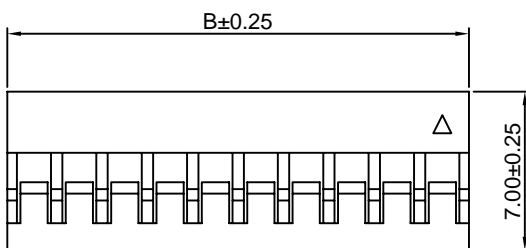
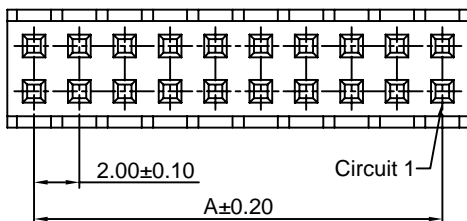

A2005HB-N-2-F

2.00mm Pitch Dual Row Housing

Reference Informations:

- *Material: Nylon 66, UL94V-0
- *Suitable CJT A2005-B series Terminal
- *Mates with CJT A2005 series Dual Row Wafer
- *Color: Black

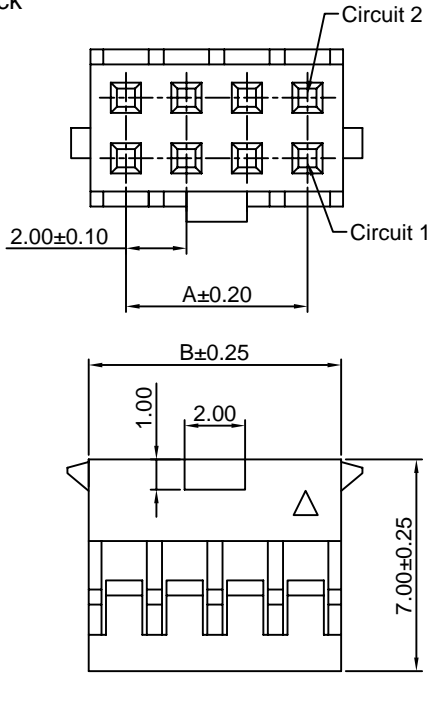
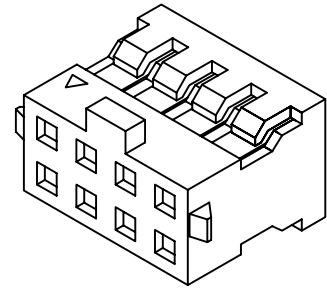

Ordering Information & Dimensions:

| PART NO. | Dimensions | |
|------------------|------------|-------|
| | A | B |
| A2005HB-N-2x2P-F | 2.00 | 4.35 |
| A2005HB-N-2x3P-F | 4.00 | 6.35 |
| A2005HB-N-2x4P-F | 6.00 | 8.35 |
| A2005HB-N-2x5P-F | 8.00 | 10.35 |
| A2005HB-N-2x6P-F | 10.00 | 12.35 |

Unit: mm

A2005HB-N-2-FI

2.00mm Pitch Dual Row Housing

Reference Informations:

- *Material: Nylon 66, UL94V-0
- *Suitable CJT A2005 series Terminal
- *Mates with CJT A2005WV-N-FI series Dual Row Wafer
- *Color: Black

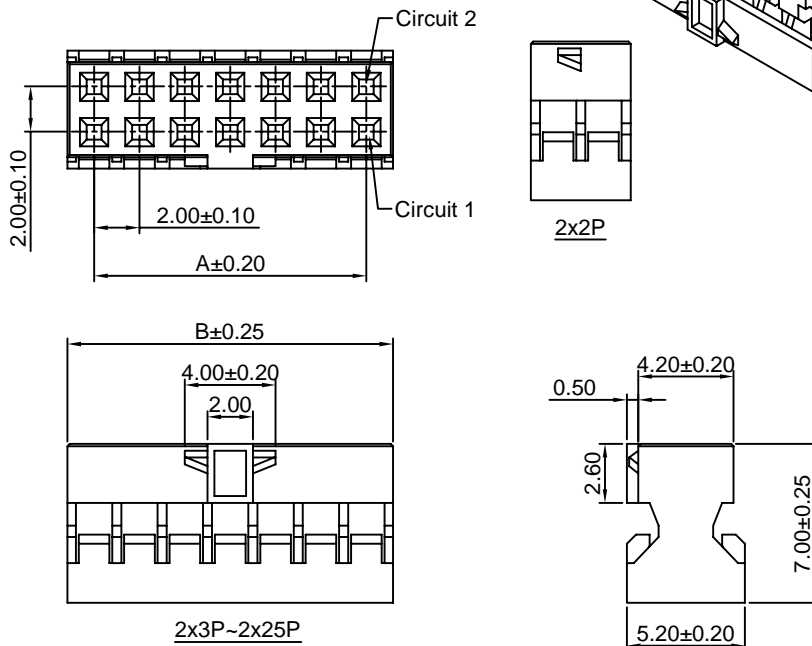
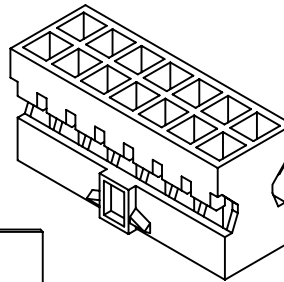

Ordering Information & Dimensions:

| PART NO. | Dimensions | |
|--------------------|------------|-------|
| | A | B |
| A2005HB-N-2x2P-FI | 2.00 | 4.35 |
| A2005HB-N-2x3P-FI | 4.00 | 6.35 |
| A2005HB-N-2x4P-FI | 6.00 | 8.35 |
| A2005HB-N-2x5P-FI | 8.00 | 10.35 |
| A2005HB-N-2x6P-FI | 10.00 | 12.35 |
| A2005HB-N-2x7P-FI | 12.00 | 14.35 |
| A2005HB-N-2x8P-FI | 14.00 | 16.35 |
| A2005HB-N-2x9P-FI | 16.00 | 18.35 |
| A2005HB-N-2x10P-FI | 18.00 | 20.35 |
| A2005HB-N-2x11P-FI | 20.00 | 22.35 |
| A2005HB-N-2x12P-FI | 22.00 | 24.35 |
| A2005HB-N-2x13P-FI | 24.00 | 26.35 |
| A2005HB-N-2x14P-FI | 26.00 | 28.35 |
| A2005HB-N-2x15P-FI | 28.00 | 30.35 |
| A2005HB-N-2x16P-FI | 30.00 | 32.35 |
| A2005HB-N-2x17P-FI | 32.00 | 34.35 |
| A2005HB-N-2x18P-FI | 34.00 | 36.35 |
| A2005HB-N-2x19P-FI | 36.00 | 38.35 |
| A2005HB-N-2x20P-FI | 38.00 | 40.35 |
| A2005HB-N-2x21P-FI | 40.00 | 42.35 |
| A2005HB-N-2x22P-FI | 42.00 | 44.35 |
| A2005HB-N-2x23P-FI | 44.00 | 46.35 |
| A2005HB-N-2x24P-FI | 46.00 | 48.35 |
| A2005HB-N-2x25P-FI | 48.00 | 50.35 |

Unit: mm

A2005WV-N-2

2.00mm Pitch 180° Dual Row Box Header

Reference Informations:

- *Material: Pin: Brass/Gold over Nickel
Insulator: PBT, UL94V-0
- *Mates with CJT A2005 series Dual Row Housing
- *Color: Black



Ordering Information & Dimensions:

| PART NO. | Dimensions | | PART NO. | Dimensions | |
|-----------------|------------|-------|-----------------|------------|-------|
| | A | B | | A | B |
| A2005WV-N-2x4P | 6.00 | 15.30 | A2005WV-N-2x20P | 38.00 | 47.30 |
| A2005WV-N-2x5P | 8.00 | 17.30 | A2005WV-N-2x21P | 40.00 | 49.30 |
| A2005WV-N-2x6P | 10.00 | 19.30 | A2005WV-N-2x22P | 42.00 | 51.30 |
| A2005WV-N-2x7P | 12.00 | 21.30 | A2005WV-N-2x23P | 44.00 | 53.30 |
| A2005WV-N-2x8P | 14.00 | 23.30 | A2005WV-N-2x24P | 46.00 | 55.30 |
| A2005WV-N-2x9P | 16.00 | 25.30 | A2005WV-N-2x25P | 48.00 | 57.30 |
| A2005WV-N-2x10P | 18.00 | 27.30 | A2005WV-N-2x26P | 50.00 | 57.30 |
| A2005WV-N-2x11P | 20.00 | 29.30 | A2005WV-N-2x27P | 52.00 | 59.30 |
| A2005WV-N-2x12P | 22.00 | 31.30 | A2005WV-N-2x28P | 54.00 | 61.30 |
| A2005WV-N-2x13P | 24.00 | 33.30 | A2005WV-N-2x29P | 56.00 | 63.30 |
| A2005WV-N-2x14P | 26.00 | 35.30 | A2005WV-N-2x30P | 58.00 | 65.30 |
| A2005WV-N-2x15P | 28.00 | 37.30 | A2005WV-N-2x31P | 60.00 | 67.30 |
| A2005WV-N-2x16P | 30.00 | 39.30 | A2005WV-N-2x32P | 62.00 | 69.30 |
| A2005WV-N-2x17P | 32.00 | 41.30 | A2005WV-N-2x33P | 64.00 | 71.30 |
| A2005WV-N-2x18P | 34.00 | 43.30 | A2005WV-N-2x34P | 66.00 | 73.30 |
| A2005WV-N-2x19P | 36.00 | 45.30 | | | |

Unit: mm

A2005WR-N-2

2.00mm Pitch 90° Dual Row Box Header

Reference Informations:

- *Material: Pin: Brass/Gold over Nickel
Insulator: PBT, UL94V-0
- *Mates with CJT A2005 series Dual Row Housing
- *Color: Black



Ordering Information & Dimensions:

| PART NO. | Dimensions | | PART NO. | Dimensions | |
|-----------------|------------|-------|-----------------|------------|-------|
| | A | B | | A | B |
| A2005WR-N-2x4P | 6.00 | 15.30 | A2005WR-N-2x20P | 38.00 | 47.30 |
| A2005WR-N-2x5P | 8.00 | 17.30 | A2005WR-N-2x21P | 40.00 | 49.30 |
| A2005WR-N-2x6P | 10.00 | 19.30 | A2005WR-N-2x22P | 42.00 | 51.30 |
| A2005WR-N-2x7P | 12.00 | 21.30 | A2005WR-N-2x23P | 44.00 | 53.30 |
| A2005WR-N-2x8P | 14.00 | 23.30 | A2005WR-N-2x24P | 46.00 | 55.30 |
| A2005WR-N-2x9P | 16.00 | 25.30 | A2005WR-N-2x25P | 48.00 | 57.30 |
| A2005WR-N-2x10P | 18.00 | 27.30 | A2005WR-N-2x26P | 50.00 | 57.30 |
| A2005WR-N-2x11P | 20.00 | 29.30 | A2005WR-N-2x27P | 52.00 | 59.30 |
| A2005WR-N-2x12P | 22.00 | 31.30 | A2005WR-N-2x28P | 54.00 | 61.30 |
| A2005WR-N-2x13P | 24.00 | 33.30 | A2005WR-N-2x29P | 56.00 | 63.30 |
| A2005WR-N-2x14P | 26.00 | 35.30 | A2005WR-N-2x30P | 58.00 | 65.30 |
| A2005WR-N-2x15P | 28.00 | 37.30 | A2005WR-N-2x31P | 60.00 | 67.30 |
| A2005WR-N-2x16P | 30.00 | 39.30 | A2005WR-N-2x32P | 62.00 | 69.30 |
| A2005WR-N-2x17P | 32.00 | 41.30 | A2005WR-N-2x33P | 64.00 | 71.30 |
| A2005WR-N-2x18P | 34.00 | 43.30 | A2005WR-N-2x34P | 66.00 | 73.30 |
| A2005WR-N-2x19P | 36.00 | 45.30 | | | |

Unit: mm

A2005WV-N-2-A

2.00mm Pitch 180° Dual Row Box Header - A TYPE

Reference Informations:

- *Material: Pin: Brass/Gold over Nickel
Insulator: Nylon 6T, UL94V-0
- *Mates with CJT A2005 series Dual Row Housing
- *Color: Black

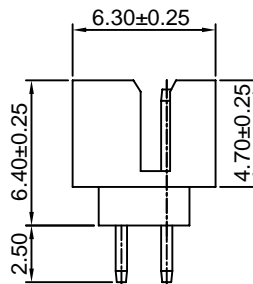
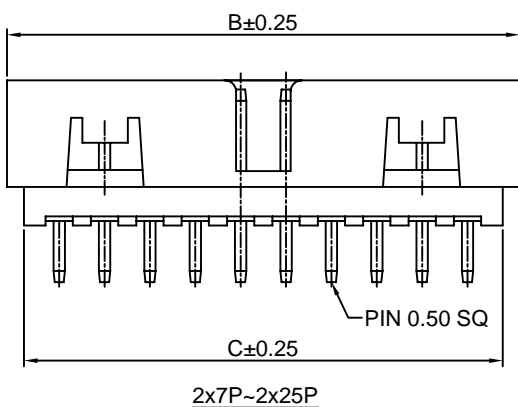
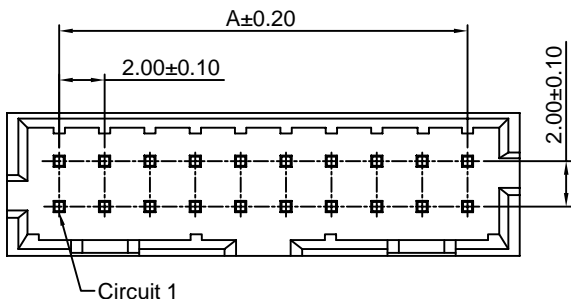
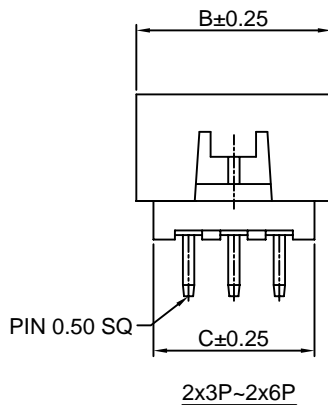
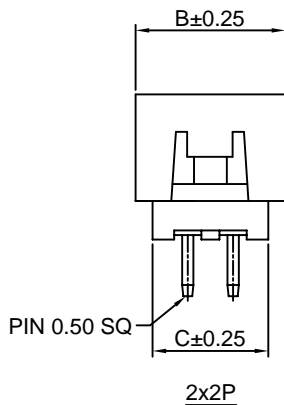
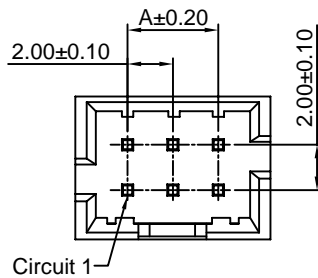
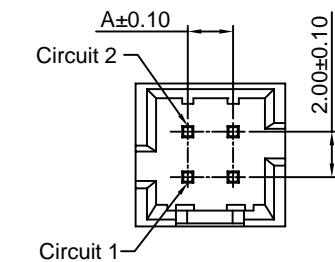
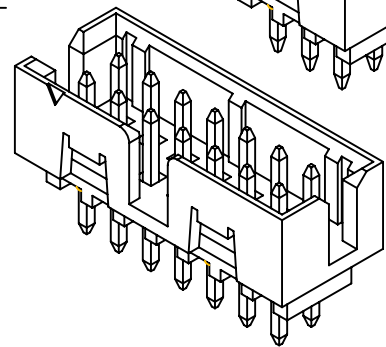
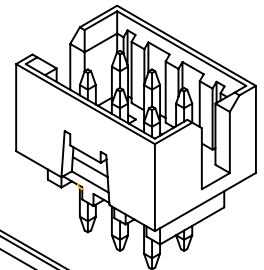

Ordering Information & Dimensions:

| PART NO. | Dimensions | | |
|-------------------|------------|-------|-------|
| | A | B | C |
| A2005WV-N-2x2P-A | 2.00 | 6.65 | 5.00 |
| A2005WV-N-2x3P-A | 4.00 | 8.65 | 7.00 |
| A2005WV-N-2x4P-A | 6.00 | 10.65 | 9.00 |
| A2005WV-N-2x5P-A | 8.00 | 12.65 | 11.00 |
| A2005WV-N-2x6P-A | 10.00 | 14.65 | 13.00 |
| A2005WV-N-2x7P-A | 12.00 | 16.65 | 15.00 |
| A2005WV-N-2x8P-A | 14.00 | 18.65 | 17.00 |
| A2005WV-N-2x9P-A | 16.00 | 20.65 | 19.00 |
| A2005WV-N-2x10P-A | 18.00 | 22.65 | 21.00 |
| A2005WV-N-2x11P-A | 20.00 | 24.65 | 23.00 |
| A2005WV-N-2x12P-A | 22.00 | 26.65 | 25.00 |
| A2005WV-N-2x13P-A | 24.00 | 28.65 | 27.00 |
| A2005WV-N-2x14P-A | 26.00 | 30.65 | 29.00 |
| A2005WV-N-2x15P-A | 28.00 | 32.65 | 31.00 |
| A2005WV-N-2x16P-A | 30.00 | 34.65 | 33.00 |
| A2005WV-N-2x17P-A | 32.00 | 36.65 | 35.00 |
| A2005WV-N-2x18P-A | 34.00 | 38.65 | 37.00 |
| A2005WV-N-2x19P-A | 36.00 | 40.65 | 39.00 |
| A2005WV-N-2x20P-A | 38.00 | 42.65 | 41.00 |
| A2005WV-N-2x21P-A | 30.00 | 44.65 | 43.00 |
| A2005WV-N-2x22P-A | 32.00 | 46.65 | 45.00 |
| A2005WV-N-2x23P-A | 34.00 | 48.65 | 47.00 |
| A2005WV-N-2x24P-A | 36.00 | 50.65 | 49.00 |
| A2005WV-N-2x25P-A | 38.00 | 52.65 | 51.00 |

Unit: mm

A2005WV-N-2-B

2.00mm Pitch 180° Dual Row Box Header - B TYPE

Reference Informations:

- *Material: Pin: Brass/Gold over Nickel
Insulator: Nylon 6T, UL94V-0
- *Mates with CJT A2005 series Dual Row Housing
- *Color: Black

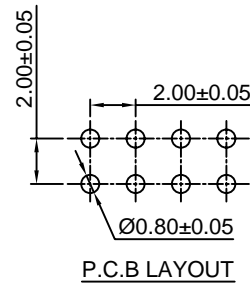
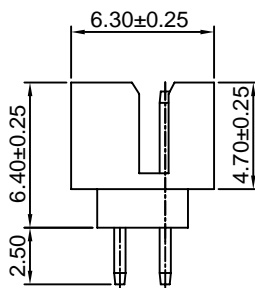
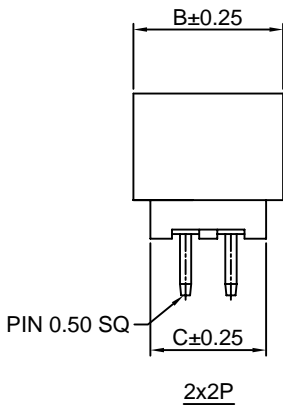

Ordering Information & Dimensions:

| PART NO. | Dimensions | | |
|-------------------|------------|-------|-------|
| | A | B | C |
| A2005WV-N-2x2P-B | 2.00 | 6.65 | 5.00 |
| A2005WV-N-2x3P-B | 4.00 | 8.65 | 7.00 |
| A2005WV-N-2x4P-B | 6.00 | 10.65 | 9.00 |
| A2005WV-N-2x5P-B | 8.00 | 12.65 | 11.00 |
| A2005WV-N-2x6P-B | 10.00 | 14.65 | 13.00 |
| A2005WV-N-2x7P-B | 12.00 | 16.65 | 15.00 |
| A2005WV-N-2x8P-B | 14.00 | 18.65 | 17.00 |
| A2005WV-N-2x9P-B | 16.00 | 20.65 | 19.00 |
| A2005WV-N-2x10P-B | 18.00 | 22.65 | 21.00 |
| A2005WV-N-2x11P-B | 20.00 | 24.65 | 23.00 |
| A2005WV-N-2x12P-B | 22.00 | 26.65 | 25.00 |
| A2005WV-N-2x13P-B | 24.00 | 28.65 | 27.00 |
| A2005WV-N-2x14P-B | 26.00 | 30.65 | 29.00 |
| A2005WV-N-2x15P-B | 28.00 | 32.65 | 31.00 |
| A2005WV-N-2x16P-B | 30.00 | 34.65 | 33.00 |
| A2005WV-N-2x17P-B | 32.00 | 36.65 | 35.00 |
| A2005WV-N-2x18P-B | 34.00 | 38.65 | 37.00 |
| A2005WV-N-2x19P-B | 36.00 | 40.65 | 39.00 |
| A2005WV-N-2x20P-B | 38.00 | 42.65 | 41.00 |
| A2005WV-N-2x21P-B | 30.00 | 44.65 | 43.00 |
| A2005WV-N-2x22P-B | 32.00 | 46.65 | 45.00 |
| A2005WV-N-2x23P-B | 34.00 | 48.65 | 47.00 |
| A2005WV-N-2x24P-B | 36.00 | 50.65 | 49.00 |
| A2005WV-N-2x25P-B | 38.00 | 52.65 | 51.00 |

Unit: mm

A2005WV-N-S-2-A

2.00mm Pitch 180° Dual Row Box Header - SMT A TYPE

Reference Informations:

- *Material: Pin: Brass/Gold over Nickel
Insulator: Nylon 6T, UL94V-0
- *Mates with CJT A2005 series Dual Row Housing
- *Color: Black

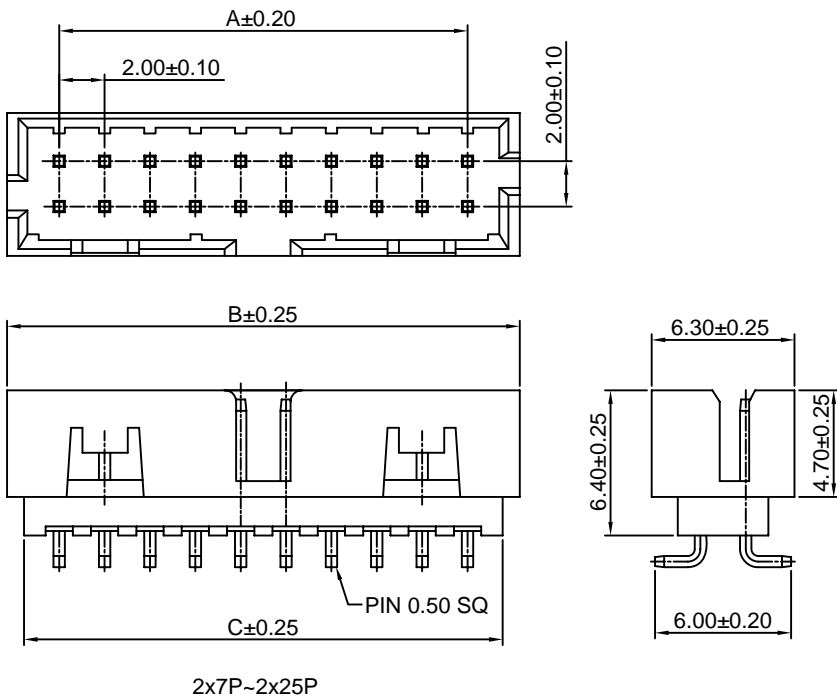
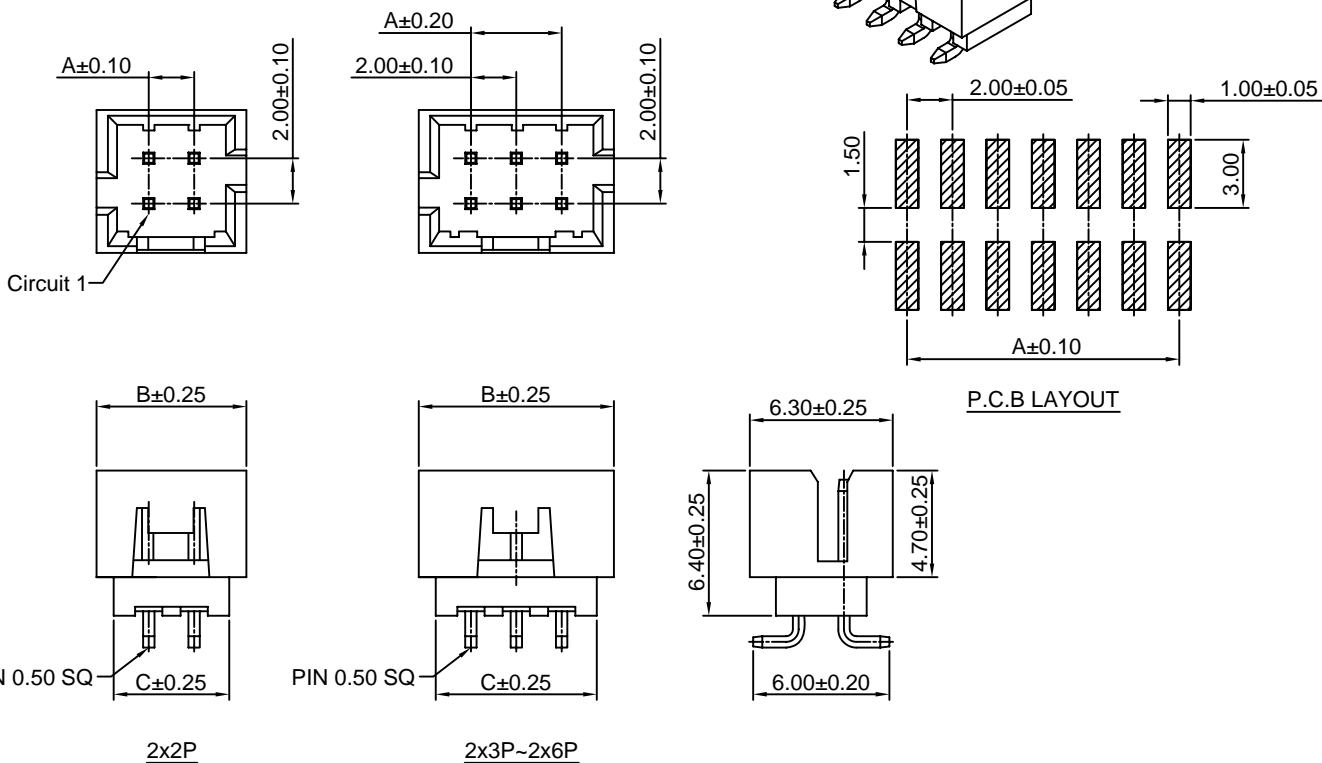
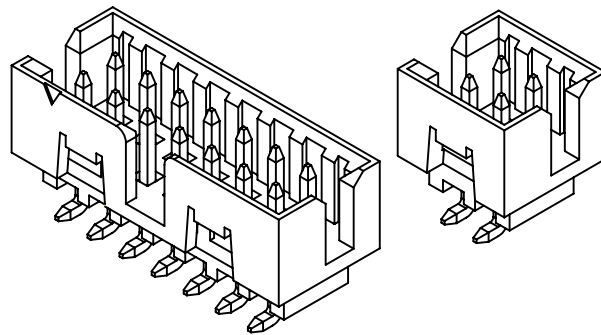

Ordering Information & Dimensions:

| PART NO. | Dimensions | | |
|---------------------|------------|-------|-------|
| | A | B | C |
| A2005WV-N-S-2x2P-A | 2.00 | 6.65 | 5.00 |
| A2005WV-N-S-2x3P-A | 4.00 | 8.65 | 7.00 |
| A2005WV-N-S-2x4P-A | 6.00 | 10.65 | 9.00 |
| A2005WV-N-S-2x5P-A | 8.00 | 12.65 | 11.00 |
| A2005WV-N-S-2x6P-A | 10.00 | 14.65 | 13.00 |
| A2005WV-N-S-2x7P-A | 12.00 | 16.65 | 15.00 |
| A2005WV-N-S-2x8P-A | 14.00 | 18.65 | 17.00 |
| A2005WV-N-S-2x9P-A | 16.00 | 20.65 | 19.00 |
| A2005WV-N-S-2x10P-A | 18.00 | 22.65 | 21.00 |
| A2005WV-N-S-2x11P-A | 20.00 | 24.65 | 23.00 |
| A2005WV-N-S-2x12P-A | 22.00 | 26.65 | 25.00 |
| A2005WV-N-S-2x13P-A | 24.00 | 28.65 | 27.00 |
| A2005WV-N-S-2x14P-A | 26.00 | 30.65 | 29.00 |
| A2005WV-N-S-2x15P-A | 28.00 | 32.65 | 31.00 |
| A2005WV-N-S-2x16P-A | 30.00 | 34.65 | 33.00 |
| A2005WV-N-S-2x17P-A | 32.00 | 36.65 | 35.00 |
| A2005WV-N-S-2x18P-A | 34.00 | 38.65 | 37.00 |
| A2005WV-N-S-2x19P-A | 36.00 | 40.65 | 39.00 |
| A2005WV-N-S-2x20P-A | 38.00 | 42.65 | 41.00 |
| A2005WV-N-S-2x21P-A | 30.00 | 44.65 | 43.00 |
| A2005WV-N-S-2x22P-A | 32.00 | 46.65 | 45.00 |
| A2005WV-N-S-2x23P-A | 34.00 | 48.65 | 47.00 |
| A2005WV-N-S-2x24P-A | 36.00 | 50.65 | 49.00 |
| A2005WV-N-S-2x25P-A | 38.00 | 52.65 | 51.00 |

Unit: mm

A2005WV-N-S-2-B

2.00mm Pitch 180° Dual Row Box Header - SMT B TYPE

Reference Informations:

- *Material: Pin: Brass/Gold over Nickel
Insulator: Nylon 6T, UL94V-0
- *Mates with CJT A2005 series Dual Row Housing
- *Color: Black

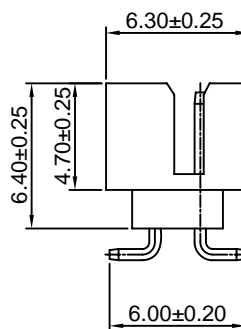
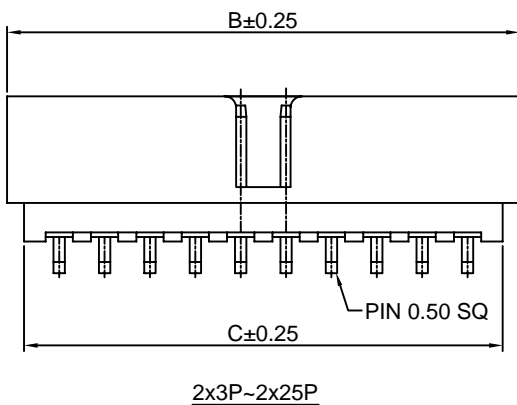
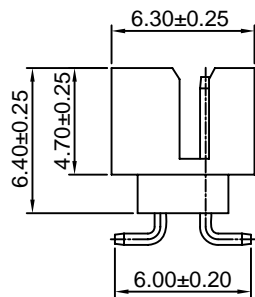
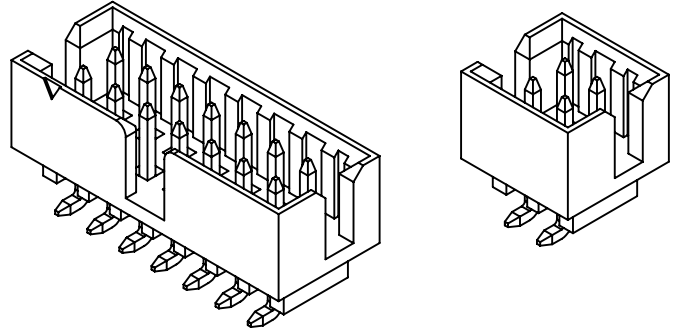
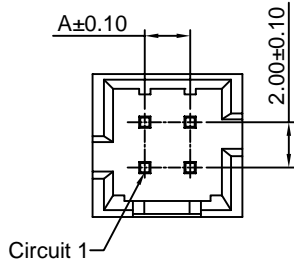

Ordering Information & Dimensions:

| PART NO. | Dimensions | | |
|---------------------|------------|-------|-------|
| | A | B | C |
| A2005WV-N-S-2x2P-B | 2.00 | 6.65 | 5.00 |
| A2005WV-N-S-2x3P-B | 4.00 | 8.65 | 7.00 |
| A2005WV-N-S-2x4P-B | 6.00 | 10.65 | 9.00 |
| A2005WV-N-S-2x5P-B | 8.00 | 12.65 | 11.00 |
| A2005WV-N-S-2x6P-B | 10.00 | 14.65 | 13.00 |
| A2005WV-N-S-2x7P-B | 12.00 | 16.65 | 15.00 |
| A2005WV-N-S-2x8P-B | 14.00 | 18.65 | 17.00 |
| A2005WV-N-S-2x9P-B | 16.00 | 20.65 | 19.00 |
| A2005WV-N-S-2x10P-B | 18.00 | 22.65 | 21.00 |
| A2005WV-N-S-2x11P-B | 20.00 | 24.65 | 23.00 |
| A2005WV-N-S-2x12P-B | 22.00 | 26.65 | 25.00 |
| A2005WV-N-S-2x13P-B | 24.00 | 28.65 | 27.00 |
| A2005WV-N-S-2x14P-B | 26.00 | 30.65 | 29.00 |
| A2005WV-N-S-2x15P-B | 28.00 | 32.65 | 31.00 |
| A2005WV-N-S-2x16P-B | 30.00 | 34.65 | 33.00 |
| A2005WV-N-S-2x17P-B | 32.00 | 36.65 | 35.00 |
| A2005WV-N-S-2x18P-B | 34.00 | 38.65 | 37.00 |
| A2005WV-N-S-2x19P-B | 36.00 | 40.65 | 39.00 |
| A2005WV-N-S-2x20P-B | 38.00 | 42.65 | 41.00 |
| A2005WV-N-S-2x21P-B | 30.00 | 44.65 | 43.00 |
| A2005WV-N-S-2x22P-B | 32.00 | 46.65 | 45.00 |
| A2005WV-N-S-2x23P-B | 34.00 | 48.65 | 47.00 |
| A2005WV-N-S-2x24P-B | 36.00 | 50.65 | 49.00 |
| A2005WV-N-S-2x25P-B | 38.00 | 52.65 | 51.00 |

Unit: mm

A2005WV-N-S-F-2-A

2.00mm Pitch 180° Dual Row Box Header - SMT A TYPE

Reference Informations:

- *Material: Pin: Brass/Gold over Nickel
Insulator: Nylon 6T, UL94V-0
- *Mates with CJT A2005 series Dual Row Housing
- *Color: Black

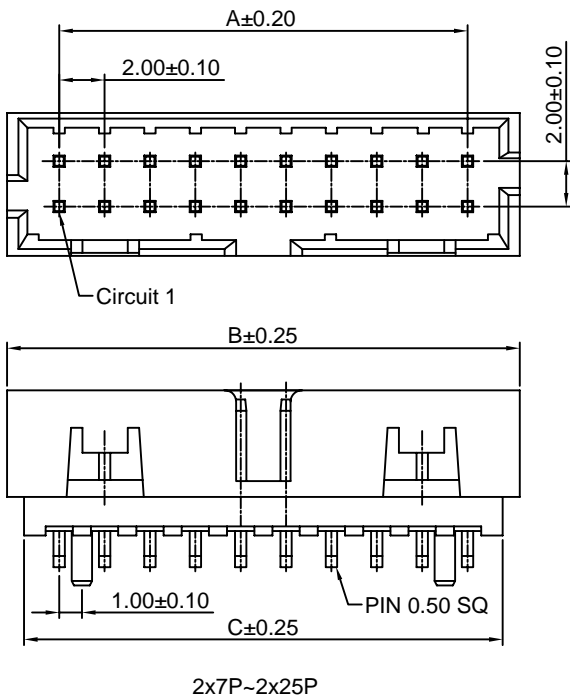
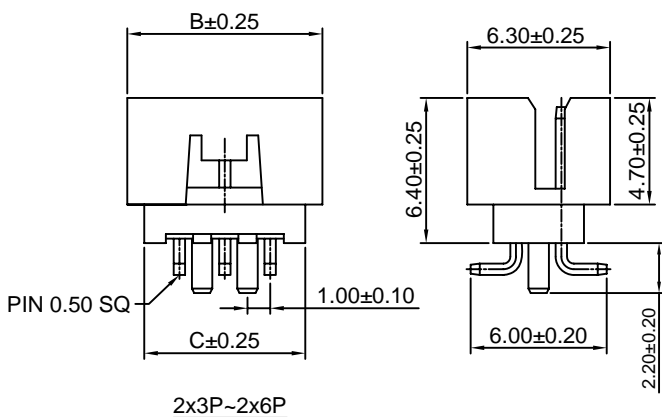

Ordering Information & Dimensions:

| PART NO. | Dimensions | | |
|-----------------------|------------|-------|-------|
| | A | B | C |
| A2005WV-N-S-F-2x3P-A | 4.00 | 8.65 | 7.00 |
| A2005WV-N-S-F-2x4P-A | 6.00 | 10.65 | 9.00 |
| A2005WV-N-S-F-2x5P-A | 8.00 | 12.65 | 11.00 |
| A2005WV-N-S-F-2x6P-A | 10.00 | 14.65 | 13.00 |
| A2005WV-N-S-F-2x7P-A | 12.00 | 16.65 | 15.00 |
| A2005WV-N-S-F-2x8P-A | 14.00 | 18.65 | 17.00 |
| A2005WV-N-S-F-2x9P-A | 16.00 | 20.65 | 19.00 |
| A2005WV-N-S-F-2x10P-A | 18.00 | 22.65 | 21.00 |
| A2005WV-N-S-F-2x11P-A | 20.00 | 24.65 | 23.00 |
| A2005WV-N-S-F-2x12P-A | 22.00 | 26.65 | 25.00 |
| A2005WV-N-S-F-2x13P-A | 24.00 | 28.65 | 27.00 |
| A2005WV-N-S-F-2x14P-A | 26.00 | 30.65 | 29.00 |
| A2005WV-N-S-F-2x15P-A | 28.00 | 32.65 | 31.00 |
| A2005WV-N-S-F-2x16P-A | 30.00 | 34.65 | 33.00 |
| A2005WV-N-S-F-2x17P-A | 32.00 | 36.65 | 35.00 |
| A2005WV-N-S-F-2x18P-A | 34.00 | 38.65 | 37.00 |
| A2005WV-N-S-F-2x19P-A | 36.00 | 40.65 | 39.00 |
| A2005WV-N-S-F-2x20P-A | 38.00 | 42.65 | 41.00 |
| A2005WV-N-S-F-2x21P-A | 30.00 | 44.65 | 43.00 |
| A2005WV-N-S-F-2x22P-A | 32.00 | 46.65 | 45.00 |
| A2005WV-N-S-F-2x23P-A | 34.00 | 48.65 | 47.00 |
| A2005WV-N-S-F-2x24P-A | 36.00 | 50.65 | 49.00 |
| A2005WV-N-S-F-2x25P-A | 38.00 | 52.65 | 51.00 |

Unit: mm

A2005WV-N-S-F-2-B

2.00mm Pitch 180° Dual Row Box Header - SMT B TYPE

Reference Informations:

- *Material: Pin: Brass/Gold over Nickel
Insulator: Nylon 6T, UL94V-0
- *Mates with CJT A2005 series Dual Row Housing
- *Color: Black

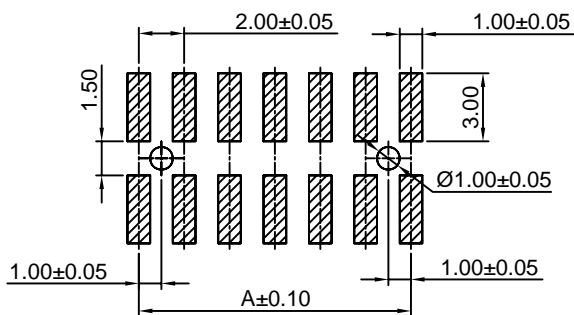
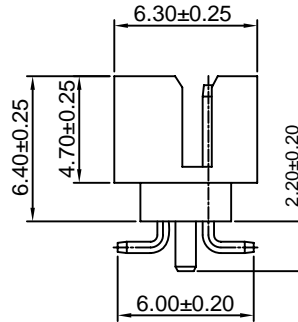
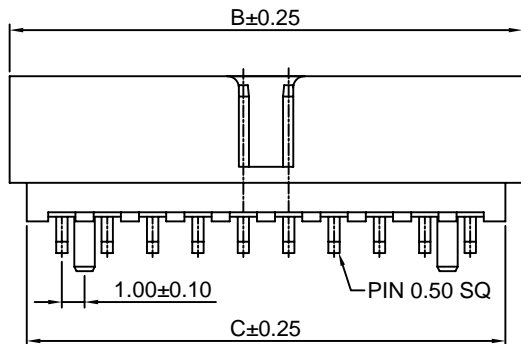
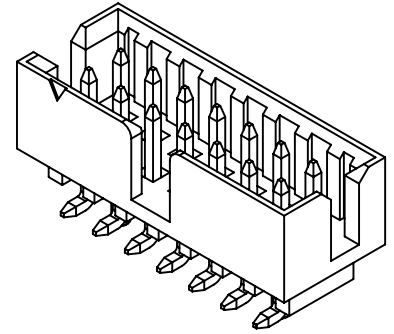
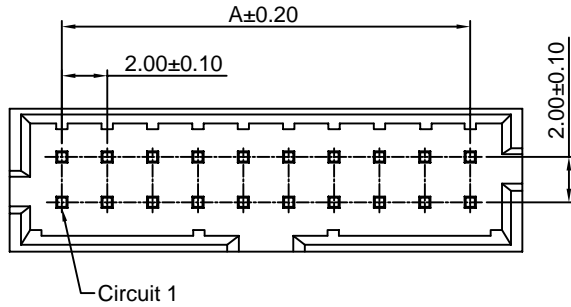

P.C.B LAYOUT

Ordering Information & Dimensions:

| PART NO. | Dimensions | | |
|-----------------------|------------|-------|-------|
| | A | B | C |
| A2005WV-N-S-F-2x3P-B | 4.00 | 8.65 | 7.00 |
| A2005WV-N-S-F-2x4P-B | 6.00 | 10.65 | 9.00 |
| A2005WV-N-S-F-2x5P-B | 8.00 | 12.65 | 11.00 |
| A2005WV-N-S-F-2x6P-B | 10.00 | 14.65 | 13.00 |
| A2005WV-N-S-F-2x7P-B | 12.00 | 16.65 | 15.00 |
| A2005WV-N-S-F-2x8P-B | 14.00 | 18.65 | 17.00 |
| A2005WV-N-S-F-2x9P-B | 16.00 | 20.65 | 19.00 |
| A2005WV-N-S-F-2x10P-B | 18.00 | 22.65 | 21.00 |
| A2005WV-N-S-F-2x11P-B | 20.00 | 24.65 | 23.00 |
| A2005WV-N-S-F-2x12P-B | 22.00 | 26.65 | 25.00 |
| A2005WV-N-S-F-2x13P-B | 24.00 | 28.65 | 27.00 |
| A2005WV-N-S-F-2x14P-B | 26.00 | 30.65 | 29.00 |
| A2005WV-N-S-F-2x15P-B | 28.00 | 32.65 | 31.00 |
| A2005WV-N-S-F-2x16P-B | 30.00 | 34.65 | 33.00 |
| A2005WV-N-S-F-2x17P-B | 32.00 | 36.65 | 35.00 |
| A2005WV-N-S-F-2x18P-B | 34.00 | 38.65 | 37.00 |
| A2005WV-N-S-F-2x19P-B | 36.00 | 40.65 | 39.00 |
| A2005WV-N-S-F-2x20P-B | 38.00 | 42.65 | 41.00 |
| A2005WV-N-S-F-2x21P-B | 30.00 | 44.65 | 43.00 |
| A2005WV-N-S-F-2x22P-B | 32.00 | 46.65 | 45.00 |
| A2005WV-N-S-F-2x23P-B | 34.00 | 48.65 | 47.00 |
| A2005WV-N-S-F-2x24P-B | 36.00 | 50.65 | 49.00 |
| A2005WV-N-S-F-2x25P-B | 38.00 | 52.65 | 51.00 |

Unit: mm

A2005WR-N-2-A

2.00mm Pitch 90° Dual Row Box Header - A TYPE

Reference Informations:

- *Material: Pin: Brass/Gold over Nickel
Insulator: Nylon 6T, UL94V-0
- *Mates with CJT A2005 series Dual Row Housing
- *Color: Black

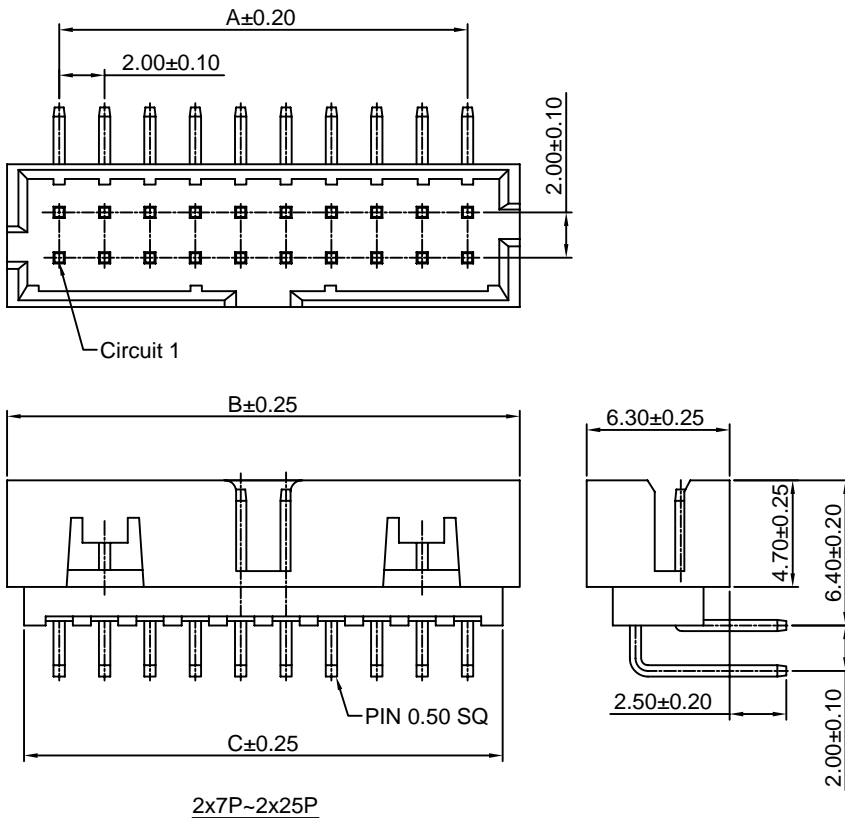
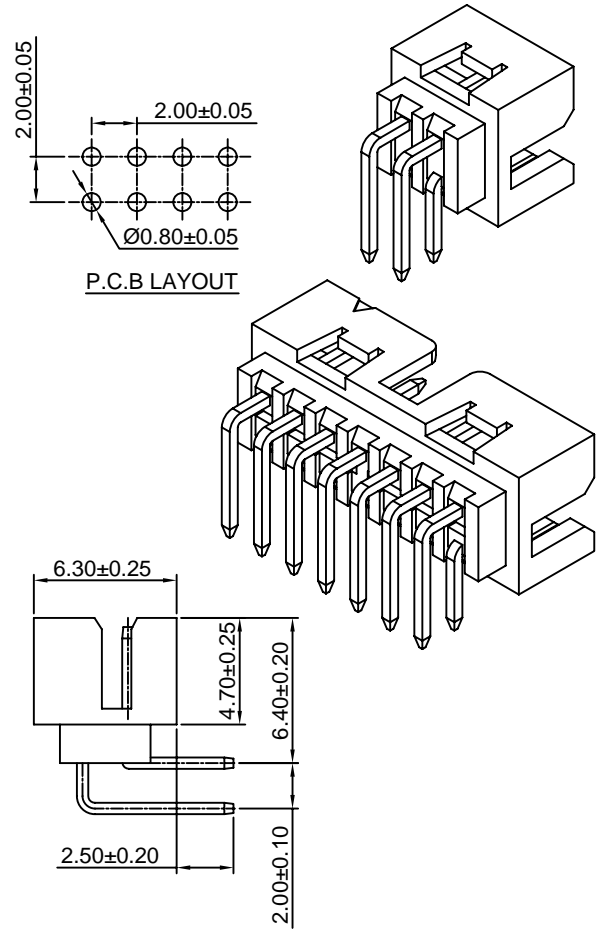
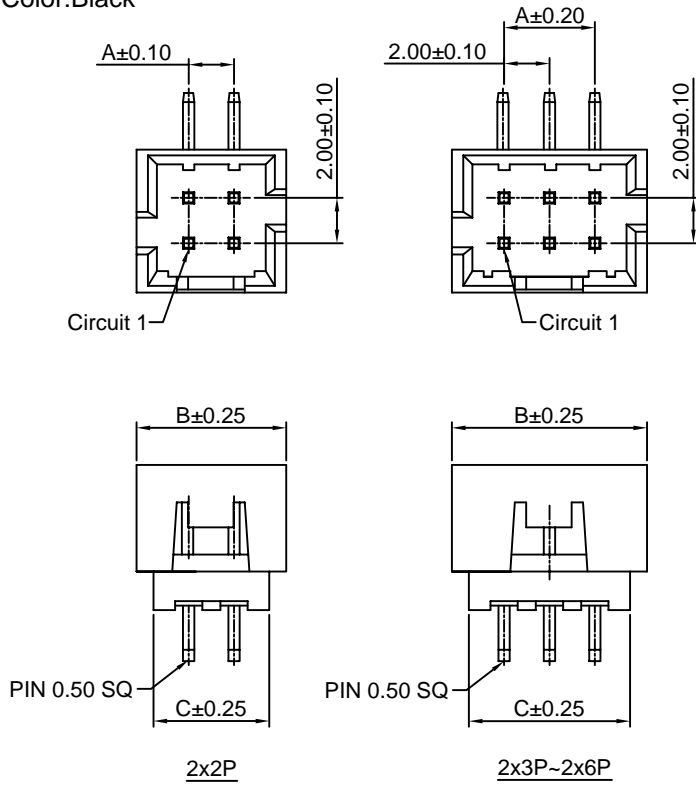

Ordering Information & Dimensions:

| PART NO. | Dimensions | | |
|-------------------|------------|-------|-------|
| | A | B | C |
| A2005WR-N-2x2P-A | 2.00 | 6.65 | 5.00 |
| A2005WR-N-2x3P-A | 4.00 | 8.65 | 7.00 |
| A2005WR-N-2x4P-A | 6.00 | 10.65 | 9.00 |
| A2005WR-N-2x5P-A | 8.00 | 12.65 | 11.00 |
| A2005WR-N-2x6P-A | 10.00 | 14.65 | 13.00 |
| A2005WR-N-2x7P-A | 12.00 | 16.65 | 15.00 |
| A2005WR-N-2x8P-A | 14.00 | 18.65 | 17.00 |
| A2005WR-N-2x9P-A | 16.00 | 20.65 | 19.00 |
| A2005WR-N-2x10P-A | 18.00 | 22.65 | 21.00 |
| A2005WR-N-2x11P-A | 20.00 | 24.65 | 23.00 |
| A2005WR-N-2x12P-A | 22.00 | 26.65 | 25.00 |
| A2005WR-N-2x13P-A | 24.00 | 28.65 | 27.00 |
| A2005WR-N-2x14P-A | 26.00 | 30.65 | 29.00 |
| A2005WR-N-2x15P-A | 28.00 | 32.65 | 31.00 |
| A2005WR-N-2x16P-A | 30.00 | 34.65 | 33.00 |
| A2005WR-N-2x17P-A | 32.00 | 36.65 | 35.00 |
| A2005WR-N-2x18P-A | 34.00 | 38.65 | 37.00 |
| A2005WR-N-2x19P-A | 36.00 | 40.65 | 39.00 |
| A2005WR-N-2x20P-A | 38.00 | 42.65 | 41.00 |
| A2005WR-N-2x21P-A | 30.00 | 44.65 | 43.00 |
| A2005WR-N-2x22P-A | 32.00 | 46.65 | 45.00 |
| A2005WR-N-2x23P-A | 34.00 | 48.65 | 47.00 |
| A2005WR-N-2x24P-A | 36.00 | 50.65 | 49.00 |
| A2005WR-N-2x25P-A | 38.00 | 52.65 | 51.00 |

Unit: mm

A2005WR-N-2-B

2.00mm Pitch 90° Dual Row Box Header - B TYPE

Reference Informations:

- *Material: Pin: Brass/Gold over Nickel
Insulator: Nylon 6T, UL94V-0
- *Mates with CJT A2005 series Dual Row Housing
- *Color: Black

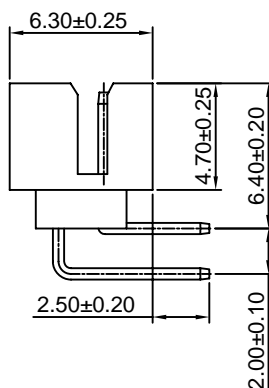
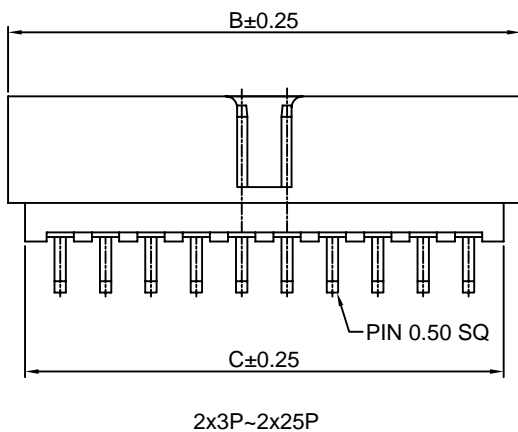
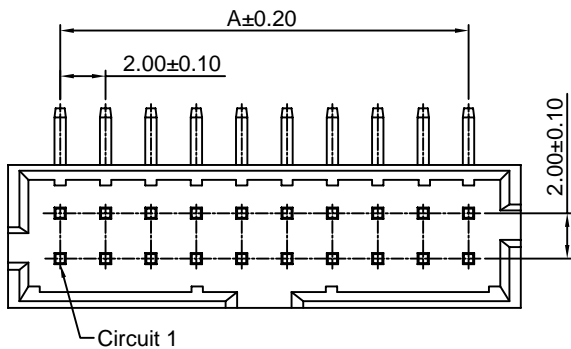
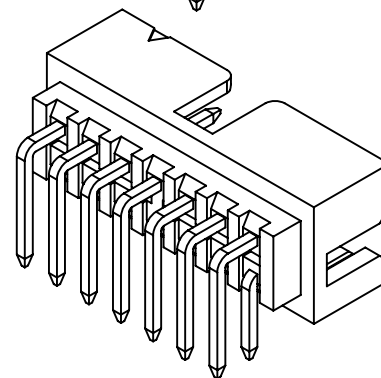
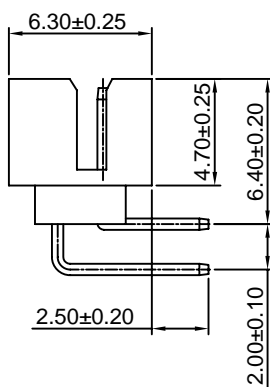
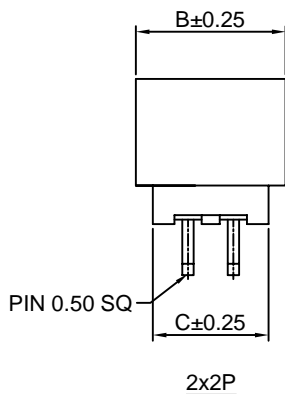
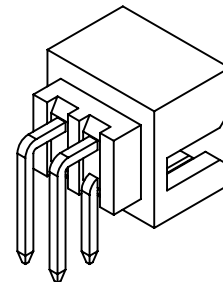
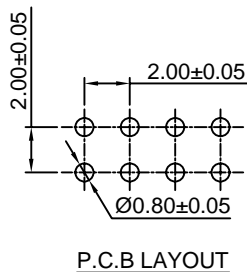
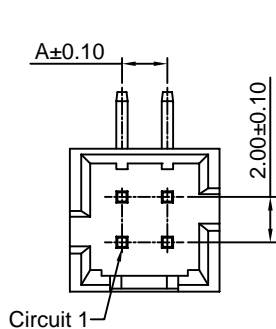

Ordering Information & Dimensions:

| PART NO. | Dimensions | | |
|-------------------|------------|-------|-------|
| | A | B | C |
| A2005WR-N-2x2P-B | 2.00 | 6.65 | 5.00 |
| A2005WR-N-2x3P-B | 4.00 | 8.65 | 7.00 |
| A2005WR-N-2x4P-B | 6.00 | 10.65 | 9.00 |
| A2005WR-N-2x5P-B | 8.00 | 12.65 | 11.00 |
| A2005WR-N-2x6P-B | 10.00 | 14.65 | 13.00 |
| A2005WR-N-2x7P-B | 12.00 | 16.65 | 15.00 |
| A2005WR-N-2x8P-B | 14.00 | 18.65 | 17.00 |
| A2005WR-N-2x9P-B | 16.00 | 20.65 | 19.00 |
| A2005WR-N-2x10P-B | 18.00 | 22.65 | 21.00 |
| A2005WR-N-2x11P-B | 20.00 | 24.65 | 23.00 |
| A2005WR-N-2x12P-B | 22.00 | 26.65 | 25.00 |
| A2005WR-N-2x13P-B | 24.00 | 28.65 | 27.00 |
| A2005WR-N-2x14P-B | 26.00 | 30.65 | 29.00 |
| A2005WR-N-2x15P-B | 28.00 | 32.65 | 31.00 |
| A2005WR-N-2x16P-B | 30.00 | 34.65 | 33.00 |
| A2005WR-N-2x17P-B | 32.00 | 36.65 | 35.00 |
| A2005WR-N-2x18P-B | 34.00 | 38.65 | 37.00 |
| A2005WR-N-2x19P-B | 36.00 | 40.65 | 39.00 |
| A2005WR-N-2x20P-B | 38.00 | 42.65 | 41.00 |
| A2005WR-N-2x21P-B | 30.00 | 44.65 | 43.00 |
| A2005WR-N-2x22P-B | 32.00 | 46.65 | 45.00 |
| A2005WR-N-2x23P-B | 34.00 | 48.65 | 47.00 |
| A2005WR-N-2x24P-B | 36.00 | 50.65 | 49.00 |
| A2005WR-N-2x25P-B | 38.00 | 52.65 | 51.00 |

Unit: mm

A2005WV-N-2-FI

2.00mm Pitch 180° Dual Row Box Header

Reference Informations:

- *Material: Pin: Brass/Gold over Nickel
Insulator: Nylon 6T, UL94V-0
- *Mates with CJT A2005HB-N-FI series Dual Row Housing
- *Color: Black

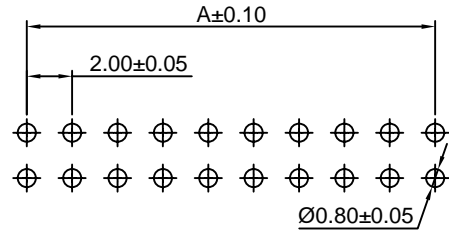
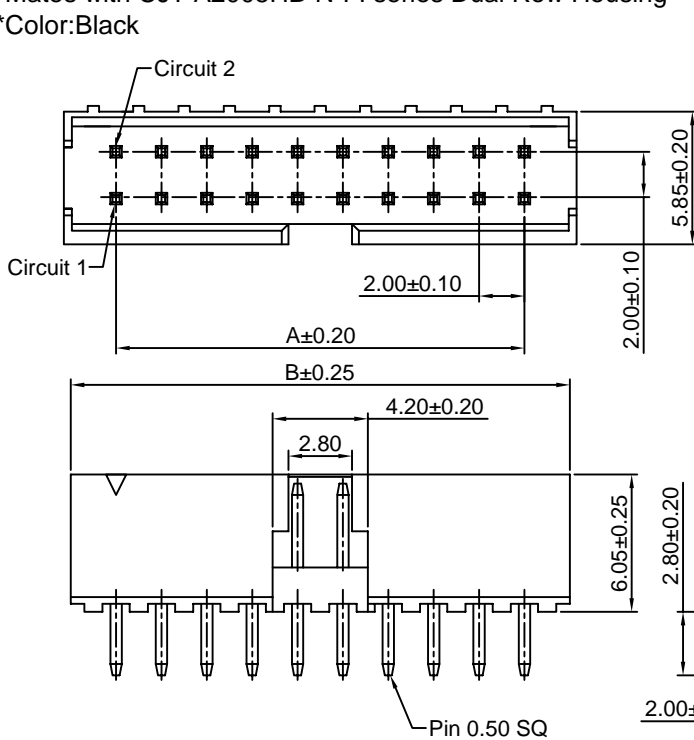

P.C.B LAYOUT

Ordering Information & Dimensions:

| PART NO. | Dimensions | |
|--------------------|------------|-------|
| | A | B |
| A2005WV-N-2x5P-FI | 8.00 | 12.00 |
| A2005WV-N-2x7P-FI | 12.00 | 16.00 |
| A2005WV-N-2x8P-FI | 14.00 | 18.00 |
| A2005WV-N-2x10P-FI | 18.00 | 22.00 |
| A2005WV-N-2x13P-FI | 24.00 | 28.00 |
| A2005WV-N-2x15P-FI | 28.00 | 32.00 |
| A2005WV-N-2x17P-FI | 32.00 | 36.00 |
| A2005WV-N-2x20P-FI | 38.00 | 42.00 |
| A2005WV-N-2x22P-FI | 42.00 | 46.00 |
| A2005WV-N-2x25P-FI | 48.00 | 52.00 |
| A2005WV-N-2x30P-FI | 58.00 | 62.00 |

Unit: mm

A2005WV-N-S-2-FI

2.00mm Pitch 180° Dual Row Box Header - SMT TYPE

Reference Informations:

- *Material: Pin: Brass/Gold over Nickel
Insulator: Nylon 6T, UL94V-0
- *Mates with CJT A2005HB-N-FI series Dual Row Housing
- *Color: Black

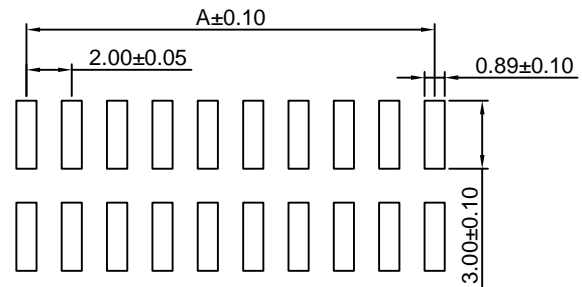
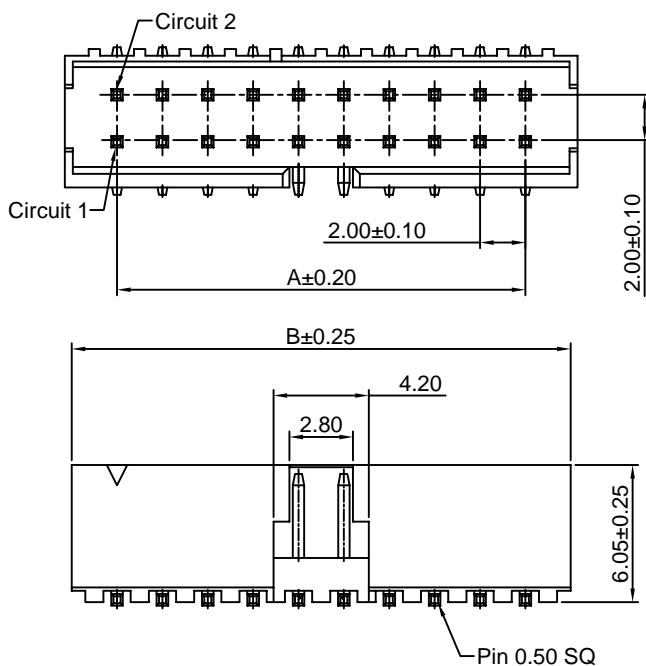

P.C.B LAYOUT

Ordering Information & Dimensions:

| PART NO. | Dimensions | |
|----------------------|------------|-------|
| | A | B |
| A2005WV-N-S-2x5P-FI | 8.00 | 12.00 |
| A2005WV-N-S-2x7P-FI | 12.00 | 16.00 |
| A2005WV-N-S-2x8P-FI | 14.00 | 18.00 |
| A2005WV-N-S-2x10P-FI | 18.00 | 22.00 |
| A2005WV-N-S-2x13P-FI | 24.00 | 28.00 |
| A2005WV-N-S-2x15P-FI | 28.00 | 32.00 |
| A2005WV-N-S-2x17P-FI | 32.00 | 36.00 |
| A2005WV-N-S-2x20P-FI | 38.00 | 42.00 |
| A2005WV-N-S-2x22P-FI | 42.00 | 46.00 |
| A2005WV-N-S-2x25P-FI | 48.00 | 52.00 |
| A2005WV-N-S-2x30P-FI | 58.00 | 62.00 |

Unit: mm

A2005HWV

2.00mm Pitch 180° Single Row Female Header

Reference Informations:

- *Material:Pin:Phosphor Bronze/Gold over Nickel
Insulator:Nylon 66,UL94V-0
- *Mates with CJT A2005 series Single Row Pin Header
- *Color:Black

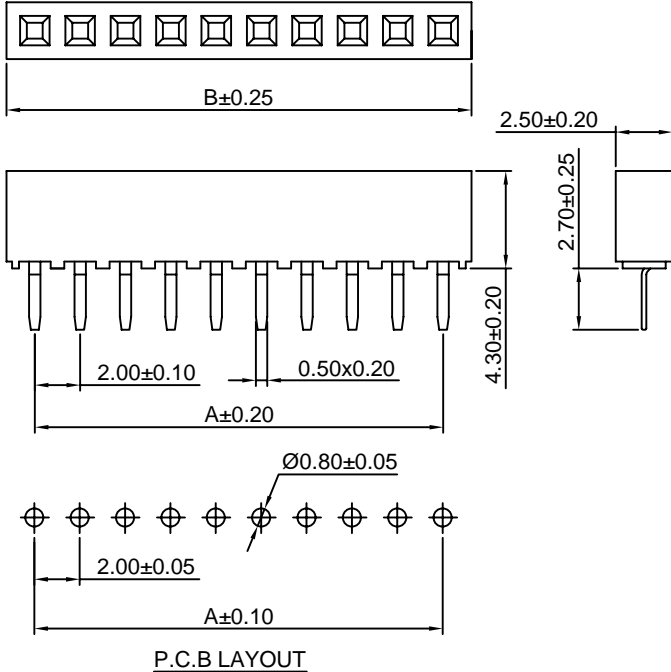
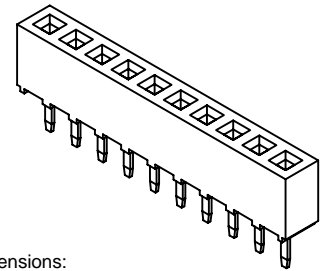

Ordering Information & Dimensions:

| PART NO. | Dimensions | | PART NO. | Dimensions | |
|--------------|------------|-------|--------------|------------|-------|
| | A | B | | A | B |
| A2005HWV-2P | 2.00 | 4.60 | A2005HWV-22P | 42.00 | 44.60 |
| A2005HWV-3P | 4.00 | 6.60 | A2005HWV-23P | 44.00 | 46.60 |
| A2005HWV-4P | 6.00 | 8.60 | A2005HWV-24P | 46.00 | 48.60 |
| A2005HWV-5P | 8.00 | 10.60 | A2005HWV-25P | 48.00 | 50.60 |
| A2005HWV-6P | 10.00 | 12.60 | A2005HWV-26P | 50.00 | 52.60 |
| A2005HWV-7P | 12.00 | 14.60 | A2005HWV-27P | 52.00 | 54.60 |
| A2005HWV-8P | 14.00 | 16.60 | A2005HWV-28P | 54.00 | 56.60 |
| A2005HWV-9P | 16.00 | 18.60 | A2005HWV-29P | 56.00 | 58.60 |
| A2005HWV-10P | 18.00 | 20.60 | A2005HWV-30P | 58.00 | 60.60 |
| A2005HWV-11P | 20.00 | 22.60 | A2005HWV-31P | 60.00 | 62.60 |
| A2005HWV-12P | 22.00 | 24.60 | A2005HWV-32P | 62.00 | 64.60 |
| A2005HWV-13P | 24.00 | 26.60 | A2005HWV-33P | 64.00 | 66.60 |
| A2005HWV-14P | 26.00 | 28.60 | A2005HWV-34P | 66.00 | 68.60 |
| A2005HWV-15P | 28.00 | 30.60 | A2005HWV-35P | 68.00 | 70.60 |
| A2005HWV-16P | 30.00 | 32.60 | A2005HWV-36P | 70.00 | 72.60 |
| A2005HWV-17P | 32.00 | 34.60 | A2005HWV-37P | 72.00 | 74.60 |
| A2005HWV-18P | 34.00 | 36.60 | A2005HWV-38P | 74.00 | 76.60 |
| A2005HWV-19P | 36.00 | 38.60 | A2005HWV-39P | 76.00 | 78.60 |
| A2005HWV-20P | 38.00 | 40.60 | A2005HWV-40P | 78.00 | 80.60 |
| A2005HWV-21P | 40.00 | 42.60 | | | |

Unit: mm

A2005HWR

2.00mm Pitch 90° Single Row Female Header

Reference Informations:

- *Material:Pin:Phosphor Bronze/Gold over Nickel
Insulator:Nylon 66,UL94V-0
- *Mates with CJT A2005 series Single Row Pin Header
- *Color:Black

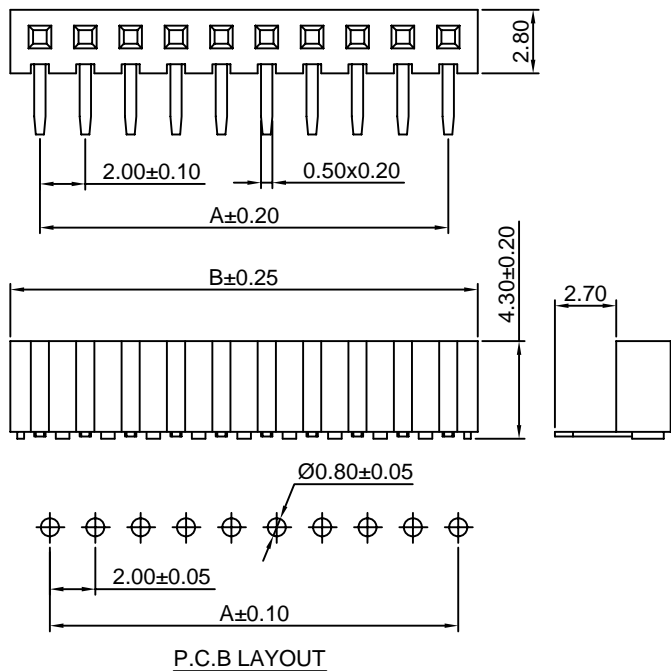
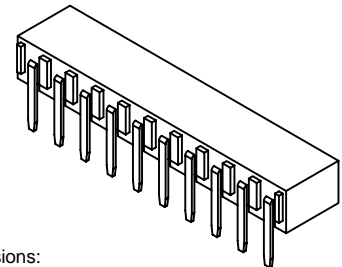

Ordering Information & Dimensions:

| PART NO. | Dimensions | | PART NO. | Dimensions | |
|--------------|------------|-------|--------------|------------|-------|
| | A | B | | A | B |
| A2005HWR-2P | 2.00 | 4.60 | A2005HWR-22P | 42.00 | 44.60 |
| A2005HWR-3P | 4.00 | 6.60 | A2005HWR-23P | 44.00 | 46.60 |
| A2005HWR-4P | 6.00 | 8.60 | A2005HWR-24P | 46.00 | 48.60 |
| A2005HWR-5P | 8.00 | 10.60 | A2005HWR-25P | 48.00 | 50.60 |
| A2005HWR-6P | 10.00 | 12.60 | A2005HWR-26P | 50.00 | 52.60 |
| A2005HWR-7P | 12.00 | 14.60 | A2005HWR-27P | 52.00 | 54.60 |
| A2005HWR-8P | 14.00 | 16.60 | A2005HWR-28P | 54.00 | 56.60 |
| A2005HWR-9P | 16.00 | 18.60 | A2005HWR-29P | 56.00 | 58.60 |
| A2005HWR-10P | 18.00 | 20.60 | A2005HWR-30P | 58.00 | 60.60 |
| A2005HWR-11P | 20.00 | 22.60 | A2005HWR-31P | 60.00 | 62.60 |
| A2005HWR-12P | 22.00 | 24.60 | A2005HWR-32P | 62.00 | 64.60 |
| A2005HWR-13P | 24.00 | 26.60 | A2005HWR-33P | 64.00 | 66.60 |
| A2005HWR-14P | 26.00 | 28.60 | A2005HWR-34P | 66.00 | 68.60 |
| A2005HWR-15P | 28.00 | 30.60 | A2005HWR-35P | 68.00 | 70.60 |
| A2005HWR-16P | 30.00 | 32.60 | A2005HWR-36P | 70.00 | 72.60 |
| A2005HWR-17P | 32.00 | 34.60 | A2005HWR-37P | 72.00 | 74.60 |
| A2005HWR-18P | 34.00 | 36.60 | A2005HWR-38P | 74.00 | 76.60 |
| A2005HWR-19P | 36.00 | 38.60 | A2005HWR-39P | 76.00 | 78.60 |
| A2005HWR-20P | 38.00 | 40.60 | A2005HWR-40P | 78.00 | 80.60 |
| A2005HWR-21P | 40.00 | 42.60 | | | |

Unit: mm

A2005HWV-A

2.00mm Pitch 180° Single Row Female Header - A TYPE

Reference Informations:

- *Material:Pin:Phophor Bronze/Gold over Nickel
Insulator:Nylon 6T,UL94V-0
- *Mates with CJT A2005 series Single Row Pin Header
- *Color:Black

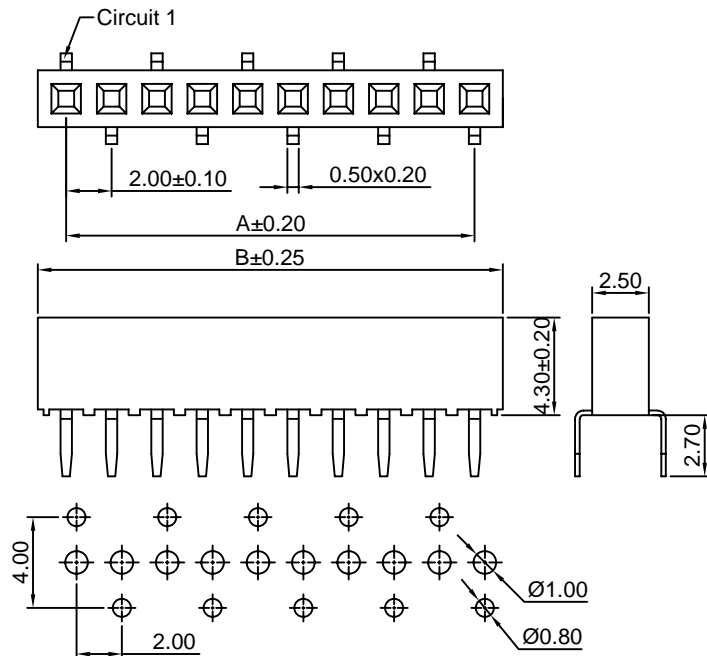

P.C.B LAYOUT

Ordering Information & Dimensions:

| PART NO. | Dimensions | | PART NO. | Dimensions | |
|----------------|------------|-------|----------------|------------|-------|
| | A | B | | A | B |
| A2005HWV-2P-A | 2.00 | 4.60 | A2005HWV-22P-A | 42.00 | 44.60 |
| A2005HWV-3P-A | 4.00 | 6.60 | A2005HWV-23P-A | 44.00 | 46.60 |
| A2005HWV-4P-A | 6.00 | 8.60 | A2005HWV-24P-A | 46.00 | 48.60 |
| A2005HWV-5P-A | 8.00 | 10.60 | A2005HWV-25P-A | 48.00 | 50.60 |
| A2005HWV-6P-A | 10.00 | 12.60 | A2005HWV-26P-A | 50.00 | 52.60 |
| A2005HWV-7P-A | 12.00 | 14.60 | A2005HWV-27P-A | 52.00 | 54.60 |
| A2005HWV-8P-A | 14.00 | 16.60 | A2005HWV-28P-A | 54.00 | 56.60 |
| A2005HWV-9P-A | 16.00 | 18.60 | A2005HWV-29P-A | 56.00 | 58.60 |
| A2005HWV-10P-A | 18.00 | 20.60 | A2005HWV-30P-A | 58.00 | 60.60 |
| A2005HWV-11P-A | 20.00 | 22.60 | A2005HWV-31P-A | 60.00 | 62.60 |
| A2005HWV-12P-A | 22.00 | 24.60 | A2005HWV-32P-A | 62.00 | 64.60 |
| A2005HWV-13P-A | 24.00 | 26.60 | A2005HWV-33P-A | 64.00 | 66.60 |
| A2005HWV-14P-A | 26.00 | 28.60 | A2005HWV-34P-A | 66.00 | 68.60 |
| A2005HWV-15P-A | 28.00 | 30.60 | A2005HWV-35P-A | 68.00 | 70.60 |
| A2005HWV-16P-A | 30.00 | 32.60 | A2005HWV-36P-A | 70.00 | 72.60 |
| A2005HWV-17P-A | 32.00 | 34.60 | A2005HWV-37P-A | 72.00 | 74.60 |
| A2005HWV-18P-A | 34.00 | 36.60 | A2005HWV-38P-A | 74.00 | 76.60 |
| A2005HWV-19P-A | 36.00 | 38.60 | A2005HWV-39P-A | 76.00 | 78.60 |
| A2005HWV-20P-A | 38.00 | 40.60 | A2005HWV-40P-A | 78.00 | 80.60 |
| A2005HWV-21P-A | 40.00 | 42.60 | | | |

Unit: mm

A2005HWV-B

2.00mm Pitch 180° Single Row Female Header - B TYPE

Reference Informations:

- *Material:Pin:Phophor Bronze/Gold over Nickel
Insulator:Nylon 6T,UL94V-0
- *Mates with CJT A2005 series Single Row Pin Header
- *Color:Black

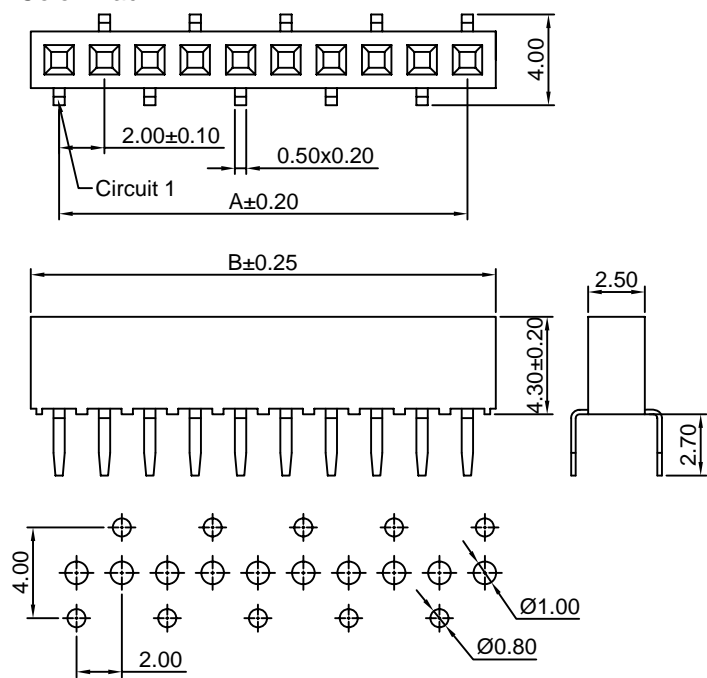

P.C.B LAYOUT

Ordering Information & Dimensions:

| PART NO. | Dimensions | | PART NO. | Dimensions | |
|----------------|------------|-------|----------------|------------|-------|
| | A | B | | A | B |
| A2005HWV-2P-B | 2.00 | 4.60 | A2005HWV-22P-B | 42.00 | 44.60 |
| A2005HWV-3P-B | 4.00 | 6.60 | A2005HWV-23P-B | 44.00 | 46.60 |
| A2005HWV-4P-B | 6.00 | 8.60 | A2005HWV-24P-B | 46.00 | 48.60 |
| A2005HWV-5P-B | 8.00 | 10.60 | A2005HWV-25P-B | 48.00 | 50.60 |
| A2005HWV-6P-B | 10.00 | 12.60 | A2005HWV-26P-B | 50.00 | 52.60 |
| A2005HWV-7P-B | 12.00 | 14.60 | A2005HWV-27P-B | 52.00 | 54.60 |
| A2005HWV-8P-B | 14.00 | 16.60 | A2005HWV-28P-B | 54.00 | 56.60 |
| A2005HWV-9P-B | 16.00 | 18.60 | A2005HWV-29P-B | 56.00 | 58.60 |
| A2005HWV-10P-B | 18.00 | 20.60 | A2005HWV-30P-B | 58.00 | 60.60 |
| A2005HWV-11P-B | 20.00 | 22.60 | A2005HWV-31P-B | 60.00 | 62.60 |
| A2005HWV-12P-B | 22.00 | 24.60 | A2005HWV-32P-B | 62.00 | 64.60 |
| A2005HWV-13P-B | 24.00 | 26.60 | A2005HWV-33P-B | 64.00 | 66.60 |
| A2005HWV-14P-B | 26.00 | 28.60 | A2005HWV-34P-B | 66.00 | 68.60 |
| A2005HWV-15P-B | 28.00 | 30.60 | A2005HWV-35P-B | 68.00 | 70.60 |
| A2005HWV-16P-B | 30.00 | 32.60 | A2005HWV-36P-B | 70.00 | 72.60 |
| A2005HWV-17P-B | 32.00 | 34.60 | A2005HWV-37P-B | 72.00 | 74.60 |
| A2005HWV-18P-B | 34.00 | 36.60 | A2005HWV-38P-B | 74.00 | 76.60 |
| A2005HWV-19P-B | 36.00 | 38.60 | A2005HWV-39P-B | 76.00 | 78.60 |
| A2005HWV-20P-B | 38.00 | 40.60 | A2005HWV-40P-B | 78.00 | 80.60 |
| A2005HWV-21P-B | 40.00 | 42.60 | | | |

Unit: mm

A2005HWV-C

2.00mm Pitch 180° Single Row Female Header - C TYPE

Reference Informations:

- *Material:Pin:Phosphor Bronze/Gold over Nickel
Insulator:Nylon 6T,UL94V-0
- *Mates with CJT A2005 series Single Row Pin Header
- *Color:Black

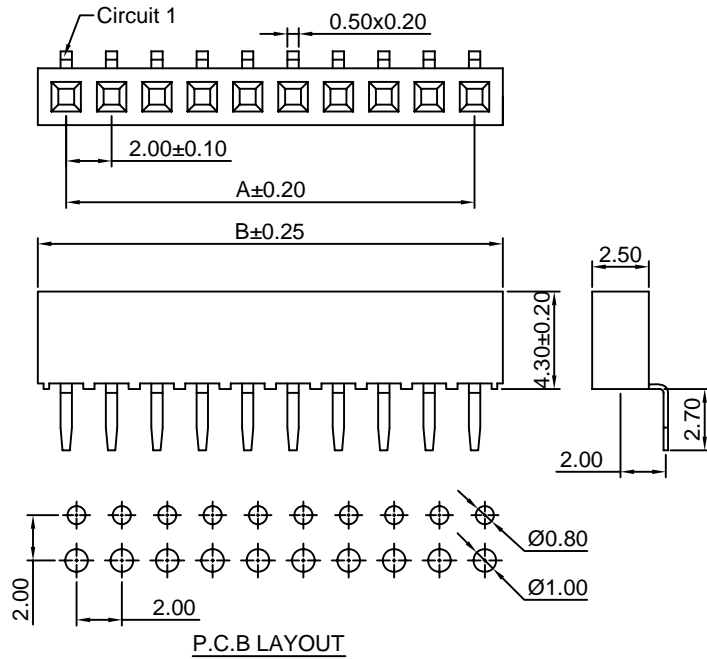

Ordering Information & Dimensions:

| PART NO. | Dimensions | | PART NO. | Dimensions | |
|----------------|------------|-------|----------------|------------|-------|
| | A | B | | A | B |
| A2005HWV-2P-C | 2.00 | 4.60 | A2005HWV-22P-C | 42.00 | 44.60 |
| A2005HWV-3P-C | 4.00 | 6.60 | A2005HWV-23P-C | 44.00 | 46.60 |
| A2005HWV-4P-C | 6.00 | 8.60 | A2005HWV-24P-C | 46.00 | 48.60 |
| A2005HWV-5P-C | 8.00 | 10.60 | A2005HWV-25P-C | 48.00 | 50.60 |
| A2005HWV-6P-C | 10.00 | 12.60 | A2005HWV-26P-C | 50.00 | 52.60 |
| A2005HWV-7P-C | 12.00 | 14.60 | A2005HWV-27P-C | 52.00 | 54.60 |
| A2005HWV-8P-C | 14.00 | 16.60 | A2005HWV-28P-C | 54.00 | 56.60 |
| A2005HWV-9P-C | 16.00 | 18.60 | A2005HWV-29P-C | 56.00 | 58.60 |
| A2005HWV-10P-C | 18.00 | 20.60 | A2005HWV-30P-C | 58.00 | 60.60 |
| A2005HWV-11P-C | 20.00 | 22.60 | A2005HWV-31P-C | 60.00 | 62.60 |
| A2005HWV-12P-C | 22.00 | 24.60 | A2005HWV-32P-C | 62.00 | 64.60 |
| A2005HWV-13P-C | 24.00 | 26.60 | A2005HWV-33P-C | 64.00 | 66.60 |
| A2005HWV-14P-C | 26.00 | 28.60 | A2005HWV-34P-C | 66.00 | 68.60 |
| A2005HWV-15P-C | 28.00 | 30.60 | A2005HWV-35P-C | 68.00 | 70.60 |
| A2005HWV-16P-C | 30.00 | 32.60 | A2005HWV-36P-C | 70.00 | 72.60 |
| A2005HWV-17P-C | 32.00 | 34.60 | A2005HWV-37P-C | 72.00 | 74.60 |
| A2005HWV-18P-C | 34.00 | 36.60 | A2005HWV-38P-C | 74.00 | 76.60 |
| A2005HWV-19P-C | 36.00 | 38.60 | A2005HWV-39P-C | 76.00 | 78.60 |
| A2005HWV-20P-C | 38.00 | 40.60 | A2005HWV-40P-C | 78.00 | 80.60 |
| A2005HWV-21P-C | 40.00 | 42.60 | | | |

Unit: mm

A2005HWV-S-A

2.00mm Pitch 180° Single Row Female Header - SMT A TYPE

Reference Informations:

- *Material:Pin:Phosphor Bronze/Gold over Nickel
Insulator:Nylon 6T,UL94V-0
- *Mates with CJT A2005 series Single Row Pin Header
- *Color:Black

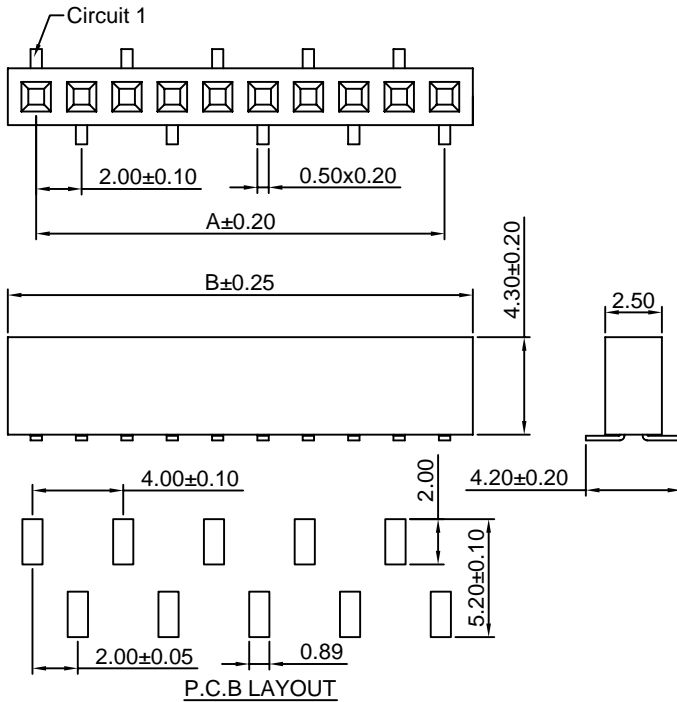
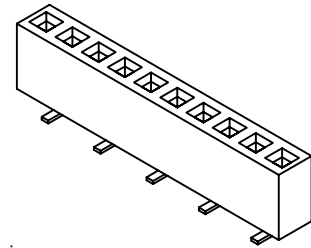

Ordering Information & Dimensions:

| PART NO. | Dimensions | | PART NO. | Dimensions | |
|------------------|------------|-------|------------------|------------|-------|
| | A | B | | A | B |
| A2005HWV-S-2P-A | 2.00 | 4.60 | A2005HWV-S-22P-A | 42.00 | 44.60 |
| A2005HWV-S-3P-A | 4.00 | 6.60 | A2005HWV-S-23P-A | 44.00 | 46.60 |
| A2005HWV-S-4P-A | 6.00 | 8.60 | A2005HWV-S-24P-A | 46.00 | 48.60 |
| A2005HWV-S-5P-A | 8.00 | 10.60 | A2005HWV-S-25P-A | 48.00 | 50.60 |
| A2005HWV-S-6P-A | 10.00 | 12.60 | A2005HWV-S-26P-A | 50.00 | 52.60 |
| A2005HWV-S-7P-A | 12.00 | 14.60 | A2005HWV-S-27P-A | 52.00 | 54.60 |
| A2005HWV-S-8P-A | 14.00 | 16.60 | A2005HWV-S-28P-A | 54.00 | 56.60 |
| A2005HWV-S-9P-A | 16.00 | 18.60 | A2005HWV-S-29P-A | 56.00 | 58.60 |
| A2005HWV-S-10P-A | 18.00 | 20.60 | A2005HWV-S-30P-A | 58.00 | 60.60 |
| A2005HWV-S-11P-A | 20.00 | 22.60 | A2005HWV-S-31P-A | 60.00 | 62.60 |
| A2005HWV-S-12P-A | 22.00 | 24.60 | A2005HWV-S-32P-A | 62.00 | 64.60 |
| A2005HWV-S-13P-A | 24.00 | 26.60 | A2005HWV-S-33P-A | 64.00 | 66.60 |
| A2005HWV-S-14P-A | 26.00 | 28.60 | A2005HWV-S-34P-A | 66.00 | 68.60 |
| A2005HWV-S-15P-A | 28.00 | 30.60 | A2005HWV-S-35P-A | 68.00 | 70.60 |
| A2005HWV-S-16P-A | 30.00 | 32.60 | A2005HWV-S-36P-A | 70.00 | 72.60 |
| A2005HWV-S-17P-A | 32.00 | 34.60 | A2005HWV-S-37P-A | 72.00 | 74.60 |
| A2005HWV-S-18P-A | 34.00 | 36.60 | A2005HWV-S-38P-A | 74.00 | 76.60 |
| A2005HWV-S-19P-A | 36.00 | 38.60 | A2005HWV-S-39P-A | 76.00 | 78.60 |
| A2005HWV-S-20P-A | 38.00 | 40.60 | A2005HWV-S-40P-A | 78.00 | 80.60 |
| A2005HWV-S-21P-A | 40.00 | 42.60 | | | |

Unit: mm

A2005HWV-S-B

2.00mm Pitch 180° Single Row Female Header - SMT B TYPE

Reference Informations:

- *Material:Pin:Phosphor Bronze/Gold over Nickel
Insulator:Nylon 6T,UL94V-0
- *Mates with CJT A2005 series Single Row Pin Header
- *Color:Black

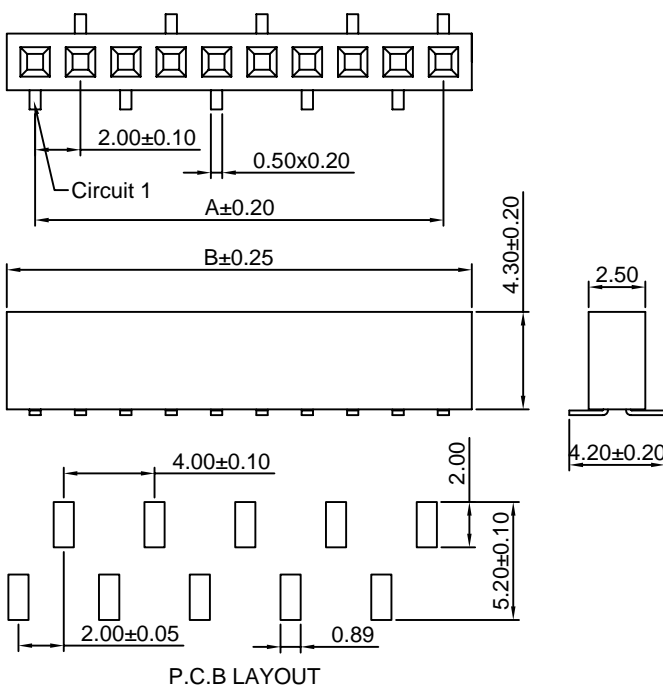
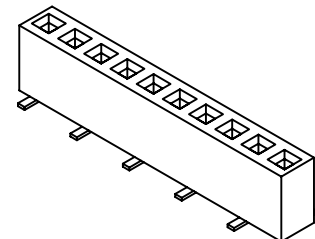

Ordering Information & Dimensions:

| PART NO. | Dimensions | | P-BART NO. | Dimensions | |
|------------------|------------|-------|------------------|------------|-------|
| | A | B | | A | B |
| A2005HWV-S-2P-B | 2.00 | 4.60 | A2005HWV-S-22P-B | 42.00 | 44.60 |
| A2005HWV-S-3P-B | 4.00 | 6.60 | A2005HWV-S-23P-B | 44.00 | 46.60 |
| A2005HWV-S-4P-B | 6.00 | 8.60 | A2005HWV-S-24P-B | 46.00 | 48.60 |
| A2005HWV-S-5P-B | 8.00 | 10.60 | A2005HWV-S-25P-B | 48.00 | 50.60 |
| A2005HWV-S-6P-B | 10.00 | 12.60 | A2005HWV-S-26P-B | 50.00 | 52.60 |
| A2005HWV-S-7P-B | 12.00 | 14.60 | A2005HWV-S-27P-B | 52.00 | 54.60 |
| A2005HWV-S-8P-B | 14.00 | 16.60 | A2005HWV-S-28P-B | 54.00 | 56.60 |
| A2005HWV-S-9P-B | 16.00 | 18.60 | A2005HWV-S-29P-B | 56.00 | 58.60 |
| A2005HWV-S-10P-B | 18.00 | 20.60 | A2005HWV-S-30P-B | 58.00 | 60.60 |
| A2005HWV-S-11P-B | 20.00 | 22.60 | A2005HWV-S-31P-B | 60.00 | 62.60 |
| A2005HWV-S-12P-B | 22.00 | 24.60 | A2005HWV-S-32P-B | 62.00 | 64.60 |
| A2005HWV-S-13P-B | 24.00 | 26.60 | A2005HWV-S-33P-B | 64.00 | 66.60 |
| A2005HWV-S-14P-B | 26.00 | 28.60 | A2005HWV-S-34P-B | 66.00 | 68.60 |
| A2005HWV-S-15P-B | 28.00 | 30.60 | A2005HWV-S-35P-B | 68.00 | 70.60 |
| A2005HWV-S-16P-B | 30.00 | 32.60 | A2005HWV-S-36P-B | 70.00 | 72.60 |
| A2005HWV-S-17P-B | 32.00 | 34.60 | A2005HWV-S-37P-B | 72.00 | 74.60 |
| A2005HWV-S-18P-B | 34.00 | 36.60 | A2005HWV-S-38P-B | 74.00 | 76.60 |
| A2005HWV-S-19P-B | 36.00 | 38.60 | A2005HWV-S-39P-B | 76.00 | 78.60 |
| A2005HWV-S-20P-B | 38.00 | 40.60 | A2005HWV-S-40P-B | 78.00 | 80.60 |
| A2005HWV-S-21P-B | 40.00 | 42.60 | | | |

Unit: mm

A2005HWV-2

2.00mm Pitch 180° Dual Row Female Header

Reference Informations:

- *Material:Pin:Phosphor Bronze/Gold over Nickel
Insulator:Nylon 66,UL94V-0
- *Mates with CJT A2005 series Dual Row Pin Header
- *Color:Black

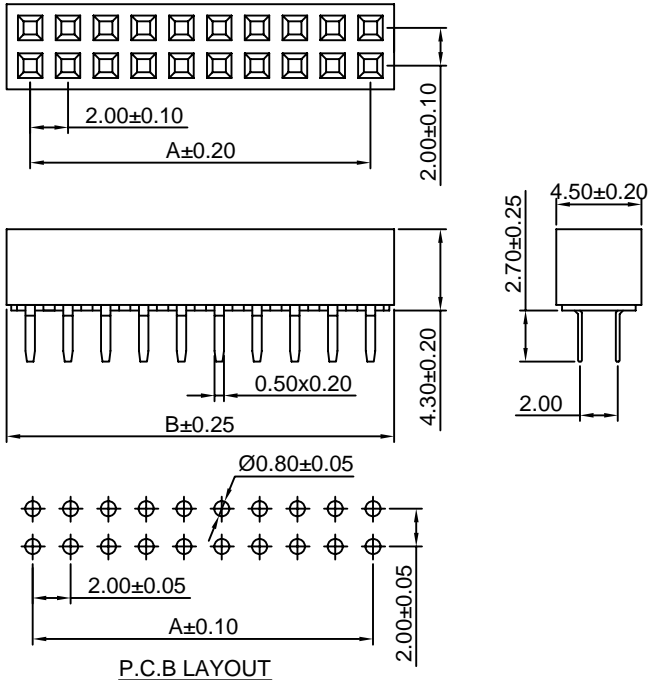
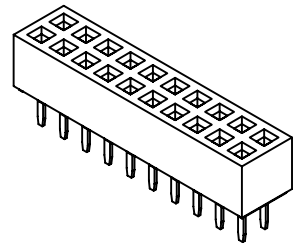

Ordering Information & Dimensions:

| PART NO. | Dimensions | | PART NO. | Dimensions | |
|----------------|------------|-------|----------------|------------|-------|
| | A | B | | A | B |
| A2005HWV-2x2P | 2.00 | 4.60 | A2005HWV-2x22P | 42.00 | 44.60 |
| A2005HWV-2x3P | 4.00 | 6.60 | A2005HWV-2x23P | 44.00 | 46.60 |
| A2005HWV-2x4P | 6.00 | 8.60 | A2005HWV-2x24P | 46.00 | 48.60 |
| A2005HWV-2x5P | 8.00 | 10.60 | A2005HWV-2x25P | 48.00 | 50.60 |
| A2005HWV-2x6P | 10.00 | 12.60 | A2005HWV-2x26P | 50.00 | 52.60 |
| A2005HWV-2x7P | 12.00 | 14.60 | A2005HWV-2x27P | 52.00 | 54.60 |
| A2005HWV-2x8P | 14.00 | 16.60 | A2005HWV-2x28P | 54.00 | 56.60 |
| A2005HWV-2x9P | 16.00 | 18.60 | A2005HWV-2x29P | 56.00 | 58.60 |
| A2005HWV-2x10P | 18.00 | 20.60 | A2005HWV-2x30P | 58.00 | 60.60 |
| A2005HWV-2x11P | 20.00 | 22.60 | A2005HWV-2x31P | 60.00 | 62.60 |
| A2005HWV-2x12P | 22.00 | 24.60 | A2005HWV-2x32P | 62.00 | 64.60 |
| A2005HWV-2x13P | 24.00 | 26.60 | A2005HWV-2x33P | 64.00 | 66.60 |
| A2005HWV-2x14P | 26.00 | 28.60 | A2005HWV-2x34P | 66.00 | 68.60 |
| A2005HWV-2x15P | 28.00 | 30.60 | A2005HWV-2x35P | 68.00 | 70.60 |
| A2005HWV-2x16P | 30.00 | 32.60 | A2005HWV-2x36P | 70.00 | 72.60 |
| A2005HWV-2x17P | 32.00 | 34.60 | A2005HWV-2x37P | 72.00 | 74.60 |
| A2005HWV-2x18P | 34.00 | 36.60 | A2005HWV-2x38P | 74.00 | 76.60 |
| A2005HWV-2x19P | 36.00 | 38.60 | A2005HWV-2x39P | 76.00 | 78.60 |
| A2005HWV-2x20P | 38.00 | 40.60 | A2005HWV-2x40P | 78.00 | 80.60 |
| A2005HWV-2x21P | 40.00 | 42.60 | | | |

Unit: mm

A2005HWR-2

2.00mm Pitch 90° Dual Row Female Header

Reference Informations:

- *Material:Pin:Phosphor Bronze/Gold over Nickel
Insulator:Nylon 66,UL94V-0
- *Mates with CJT A2005 series Dual Row Pin Header
- *Color:Black

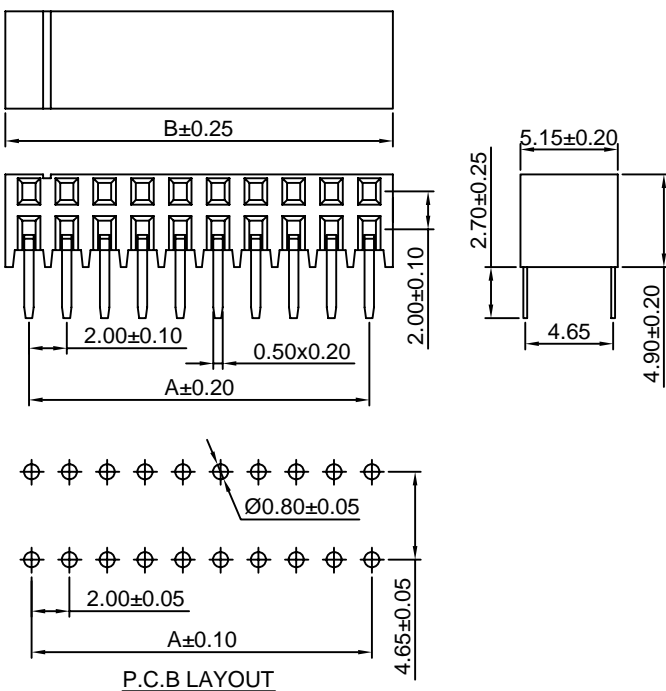

Ordering Information & Dimensions:

| PART NO. | Dimensions | | PART NO. | Dimensions | |
|----------------|------------|-------|----------------|------------|-------|
| | A | B | | A | B |
| A2005HWR-2x2P | 2.00 | 4.60 | A2005HWR-2x22P | 42.00 | 44.60 |
| A2005HWR-2x3P | 4.00 | 6.60 | A2005HWR-2x23P | 44.00 | 46.60 |
| A2005HWR-2x4P | 6.00 | 8.60 | A2005HWR-2x24P | 46.00 | 48.60 |
| A2005HWR-2x5P | 8.00 | 10.60 | A2005HWR-2x25P | 48.00 | 50.60 |
| A2005HWR-2x6P | 10.00 | 12.60 | A2005HWR-2x26P | 50.00 | 52.60 |
| A2005HWR-2x7P | 12.00 | 14.60 | A2005HWR-2x27P | 52.00 | 54.60 |
| A2005HWR-2x8P | 14.00 | 16.60 | A2005HWR-2x28P | 54.00 | 56.60 |
| A2005HWR-2x9P | 16.00 | 18.60 | A2005HWR-2x29P | 56.00 | 58.60 |
| A2005HWR-2x10P | 18.00 | 20.60 | A2005HWR-2x30P | 58.00 | 60.60 |
| A2005HWR-2x11P | 20.00 | 22.60 | A2005HWR-2x31P | 60.00 | 62.60 |
| A2005HWR-2x12P | 22.00 | 24.60 | A2005HWR-2x32P | 62.00 | 64.60 |
| A2005HWR-2x13P | 24.00 | 26.60 | A2005HWR-2x33P | 64.00 | 66.60 |
| A2005HWR-2x14P | 26.00 | 28.60 | A2005HWR-2x34P | 66.00 | 68.60 |
| A2005HWR-2x15P | 28.00 | 30.60 | A2005HWR-2x35P | 68.00 | 70.60 |
| A2005HWR-2x16P | 30.00 | 32.60 | A2005HWR-2x36P | 70.00 | 72.60 |
| A2005HWR-2x17P | 32.00 | 34.60 | A2005HWR-2x37P | 72.00 | 74.60 |
| A2005HWR-2x18P | 34.00 | 36.60 | A2005HWR-2x38P | 74.00 | 76.60 |
| A2005HWR-2x19P | 36.00 | 38.60 | A2005HWR-2x39P | 76.00 | 78.60 |
| A2005HWR-2x20P | 38.00 | 40.60 | A2005HWR-2x40P | 78.00 | 80.60 |
| A2005HWR-2x21P | 40.00 | 42.60 | | | |

Unit: mm

A2005HWR-S-2

2.00mm Pitch 90° Dual Row Female Header - SMT TYPE

Reference Informations:

- *Material:Pin:Phophor Bronze/Gold over Nickel
Insulator:Nylon 6T,UL94V-0
- *Mates with CJT A2005 series Dual Row Pin Header
- *Color:Black

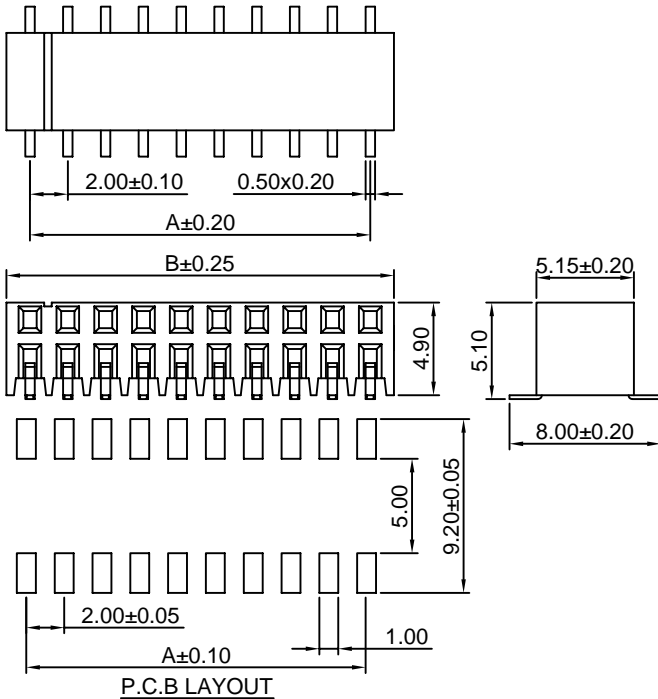

Ordering Information & Dimensions:

| PART NO. | Dimensions | | PART NO. | Dimensions | |
|------------------|------------|-------|------------------|------------|-------|
| | A | B | | A | B |
| A2005HWR-S-2x2P | 2.00 | 4.60 | A2005HWR-S-2x22P | 42.00 | 44.60 |
| A2005HWR-S-2x3P | 4.00 | 6.60 | A2005HWR-S-2x23P | 44.00 | 46.60 |
| A2005HWR-S-2x4P | 6.00 | 8.60 | A2005HWR-S-2x24P | 46.00 | 48.60 |
| A2005HWR-S-2x5P | 8.00 | 10.60 | A2005HWR-S-2x25P | 48.00 | 50.60 |
| A2005HWR-S-2x6P | 10.00 | 12.60 | A2005HWR-S-2x26P | 50.00 | 52.60 |
| A2005HWR-S-2x7P | 12.00 | 14.60 | A2005HWR-S-2x27P | 52.00 | 54.60 |
| A2005HWR-S-2x8P | 14.00 | 16.60 | A2005HWR-S-2x28P | 54.00 | 56.60 |
| A2005HWR-S-2x9P | 16.00 | 18.60 | A2005HWR-S-2x29P | 56.00 | 58.60 |
| A2005HWR-S-2x10P | 18.00 | 20.60 | A2005HWR-S-2x30P | 58.00 | 60.60 |
| A2005HWR-S-2x11P | 20.00 | 22.60 | A2005HWR-S-2x31P | 60.00 | 62.60 |
| A2005HWR-S-2x12P | 22.00 | 24.60 | A2005HWR-S-2x32P | 62.00 | 64.60 |
| A2005HWR-S-2x13P | 24.00 | 26.60 | A2005HWR-S-2x33P | 64.00 | 66.60 |
| A2005HWR-S-2x14P | 26.00 | 28.60 | A2005HWR-S-2x34P | 66.00 | 68.60 |
| A2005HWR-S-2x15P | 28.00 | 30.60 | A2005HWR-S-2x35P | 68.00 | 70.60 |
| A2005HWR-S-2x16P | 30.00 | 32.60 | A2005HWR-S-2x36P | 70.00 | 72.60 |
| A2005HWR-S-2x17P | 32.00 | 34.60 | A2005HWR-S-2x37P | 72.00 | 74.60 |
| A2005HWR-S-2x18P | 34.00 | 36.60 | A2005HWR-S-2x38P | 74.00 | 76.60 |
| A2005HWR-S-2x19P | 36.00 | 38.60 | A2005HWR-S-2x39P | 76.00 | 78.60 |
| A2005HWR-S-2x20P | 38.00 | 40.60 | A2005HWR-S-2x40P | 78.00 | 80.60 |
| A2005HWR-S-2x21P | 40.00 | 42.60 | | | |

Unit: mm

A2005HWR-S-F-2

2.00mm Pitch 90° Dual Row Female Header - SMT TYPE

Reference Informations:

- *Material:Pin:Phophor Bronze/Gold over Nickel
Insulator:Nylon 6T,UL94V-0
- *Mates with CJT A2005 series Dual Row Pin Header
- *Color:Black

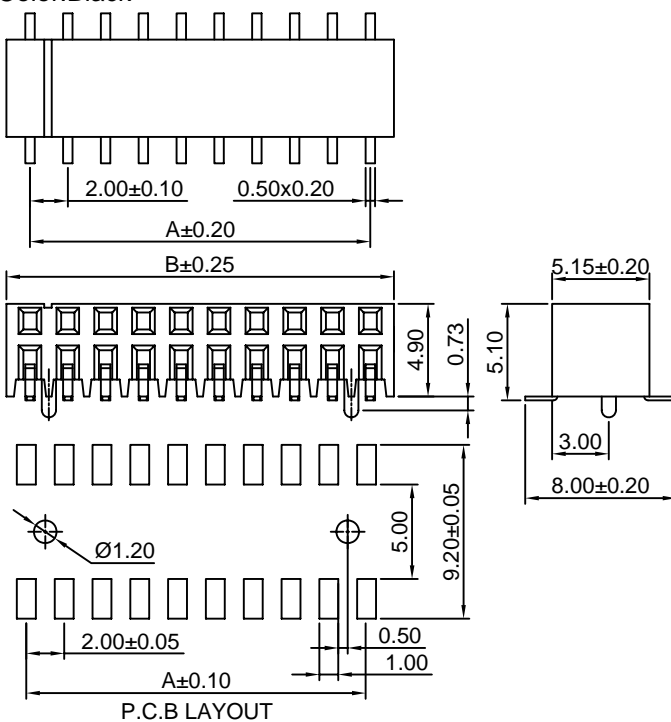

Ordering Information & Dimensions:

| PART NO. | Dimensions | | PART NO. | Dimensions | |
|--------------------|------------|-------|--------------------|------------|-------|
| | A | B | | A | B |
| A2005HWR-S-F-2x2P | 2.00 | 4.60 | A2005HWR-S-F-2x22P | 42.00 | 44.60 |
| A2005HWR-S-F-2x3P | 4.00 | 6.60 | A2005HWR-S-F-2x23P | 44.00 | 46.60 |
| A2005HWR-S-F-2x4P | 6.00 | 8.60 | A2005HWR-S-F-2x24P | 46.00 | 48.60 |
| A2005HWR-S-F-2x5P | 8.00 | 10.60 | A2005HWR-S-F-2x25P | 48.00 | 50.60 |
| A2005HWR-S-F-2x6P | 10.00 | 12.60 | A2005HWR-S-F-2x26P | 50.00 | 52.60 |
| A2005HWR-S-F-2x7P | 12.00 | 14.60 | A2005HWR-S-F-2x27P | 52.00 | 54.60 |
| A2005HWR-S-F-2x8P | 14.00 | 16.60 | A2005HWR-S-F-2x28P | 54.00 | 56.60 |
| A2005HWR-S-F-2x9P | 16.00 | 18.60 | A2005HWR-S-F-2x29P | 56.00 | 58.60 |
| A2005HWR-S-F-2x10P | 18.00 | 20.60 | A2005HWR-S-F-2x30P | 58.00 | 60.60 |
| A2005HWR-S-F-2x11P | 20.00 | 22.60 | A2005HWR-S-F-2x31P | 60.00 | 62.60 |
| A2005HWR-S-F-2x12P | 22.00 | 24.60 | A2005HWR-S-F-2x32P | 62.00 | 64.60 |
| A2005HWR-S-F-2x13P | 24.00 | 26.60 | A2005HWR-S-F-2x33P | 64.00 | 66.60 |
| A2005HWR-S-F-2x14P | 26.00 | 28.60 | A2005HWR-S-F-2x34P | 66.00 | 68.60 |
| A2005HWR-S-F-2x15P | 28.00 | 30.60 | A2005HWR-S-F-2x35P | 68.00 | 70.60 |
| A2005HWR-S-F-2x16P | 30.00 | 32.60 | A2005HWR-S-F-2x36P | 70.00 | 72.60 |
| A2005HWR-S-F-2x17P | 32.00 | 34.60 | A2005HWR-S-F-2x37P | 72.00 | 74.60 |
| A2005HWR-S-F-2x18P | 34.00 | 36.60 | A2005HWR-S-F-2x38P | 74.00 | 76.60 |
| A2005HWR-S-F-2x19P | 36.00 | 38.60 | A2005HWR-S-F-2x39P | 76.00 | 78.60 |
| A2005HWR-S-F-2x20P | 38.00 | 40.60 | A2005HWR-S-F-2x40P | 78.00 | 80.60 |
| A2005HWR-S-F-2x21P | 40.00 | 42.60 | | | |

Unit: mm

A2005HWVA-2

2.00mm Pitch 180° Dual Row Female Header

Reference Informations:

- *Material:Pin:Phosphor Bronze/Gold over Nickel
Insulator:Nylon 6T,UL94V-0
- *Mates with CJT A2005 series Dual Row Pin Header
- *Color:Black

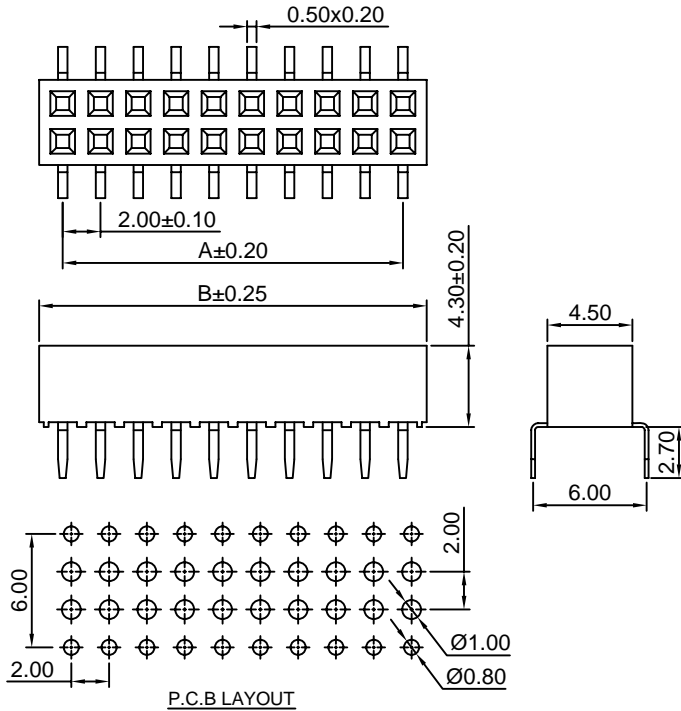

Ordering Information & Dimensions:

| PART NO. | Dimensions | | PART NO. | Dimensions | |
|-----------------|------------|-------|-----------------|------------|-------|
| | A | B | | A | B |
| A2005HWVA-2x2P | 2.00 | 4.60 | A2005HWVA-2x22P | 42.00 | 44.60 |
| A2005HWVA-2x3P | 4.00 | 6.60 | A2005HWVA-2x23P | 44.00 | 46.60 |
| A2005HWVA-2x4P | 6.00 | 8.60 | A2005HWVA-2x24P | 46.00 | 48.60 |
| A2005HWVA-2x5P | 8.00 | 10.60 | A2005HWVA-2x25P | 48.00 | 50.60 |
| A2005HWVA-2x6P | 10.00 | 12.60 | A2005HWVA-2x26P | 50.00 | 52.60 |
| A2005HWVA-2x7P | 12.00 | 14.60 | A2005HWVA-2x27P | 52.00 | 54.60 |
| A2005HWVA-2x8P | 14.00 | 16.60 | A2005HWVA-2x28P | 54.00 | 56.60 |
| A2005HWVA-2x9P | 16.00 | 18.60 | A2005HWVA-2x29P | 56.00 | 58.60 |
| A2005HWVA-2x10P | 18.00 | 20.60 | A2005HWVA-2x30P | 58.00 | 60.60 |
| A2005HWVA-2x11P | 20.00 | 22.60 | A2005HWVA-2x31P | 60.00 | 62.60 |
| A2005HWVA-2x12P | 22.00 | 24.60 | A2005HWVA-2x32P | 62.00 | 64.60 |
| A2005HWVA-2x13P | 24.00 | 26.60 | A2005HWVA-2x33P | 64.00 | 66.60 |
| A2005HWVA-2x14P | 26.00 | 28.60 | A2005HWVA-2x34P | 66.00 | 68.60 |
| A2005HWVA-2x15P | 28.00 | 30.60 | A2005HWVA-2x35P | 68.00 | 70.60 |
| A2005HWVA-2x16P | 30.00 | 32.60 | A2005HWVA-2x36P | 70.00 | 72.60 |
| A2005HWVA-2x17P | 32.00 | 34.60 | A2005HWVA-2x37P | 72.00 | 74.60 |
| A2005HWVA-2x18P | 34.00 | 36.60 | A2005HWVA-2x38P | 74.00 | 76.60 |
| A2005HWVA-2x19P | 36.00 | 38.60 | A2005HWVA-2x39P | 76.00 | 78.60 |
| A2005HWVA-2x20P | 38.00 | 40.60 | A2005HWVA-2x40P | 78.00 | 80.60 |
| A2005HWVA-2x21P | 40.00 | 42.60 | | | |

Unit: mm

A2005HWVB-2x10P

2.00mm pitch 180° Box Female Header

Reference Informations:

- *Material:Pin:Brass/Gold over Nickel
Insulator:Nylon 66,UL94V-0
- *Mates with CJT A2005 series Dual Row Pin Header
- *Color:Black

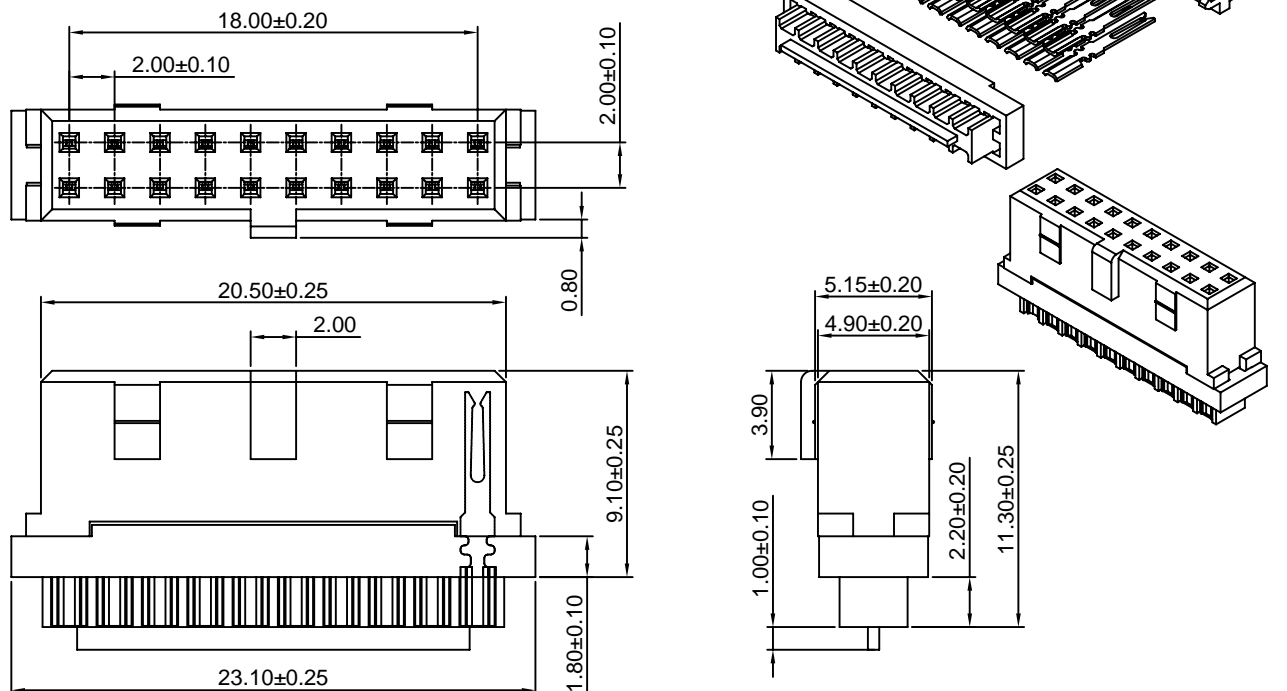

A2005HWV-3

2.00mm Pitch 180° Triple Row Female Header

Reference Informations:

- *Material:Pin:Phosphor Bronze/Gold over Nickel
Insulator:Nylon 6T,UL94V-0
- *Color:Black

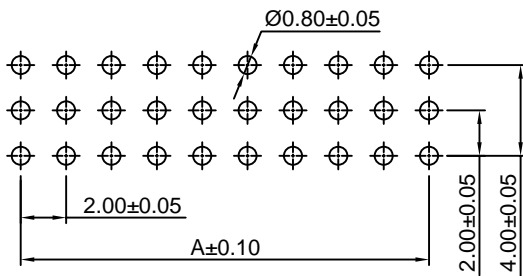
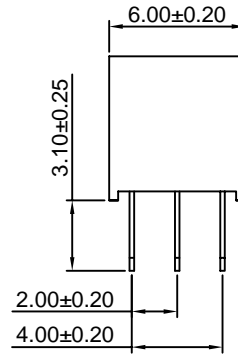
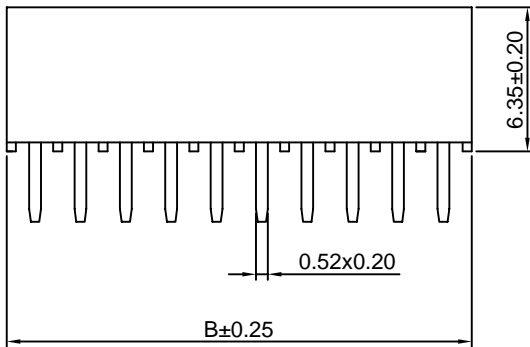
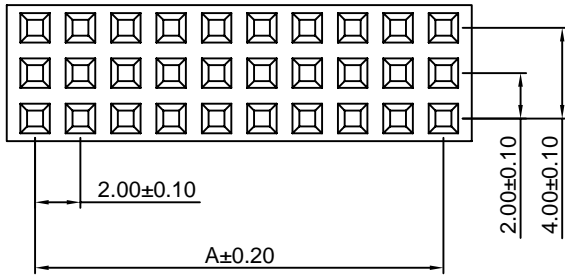
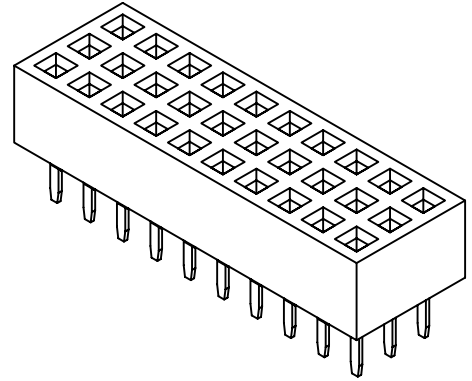

P.C.B LAYOUT

Ordering Information & Dimensions:

| PART NO. | Dimensions | | PART NO. | Dimensions | |
|----------------|------------|-------|----------------|------------|-------|
| | A | B | | A | B |
| A2005HWV-3x2P | 2.00 | 4.30 | A2005HWV-3x22P | 42.00 | 44.30 |
| A2005HWV-3x3P | 4.00 | 6.30 | A2005HWV-3x23P | 44.00 | 46.30 |
| A2005HWV-3x4P | 6.00 | 8.30 | A2005HWV-3x24P | 46.00 | 48.30 |
| A2005HWV-3x5P | 8.00 | 10.30 | A2005HWV-3x25P | 48.00 | 50.30 |
| A2005HWV-3x6P | 10.00 | 12.30 | A2005HWV-3x26P | 50.00 | 52.30 |
| A2005HWV-3x7P | 12.00 | 14.30 | A2005HWV-3x27P | 52.00 | 54.30 |
| A2005HWV-3x8P | 14.00 | 16.30 | A2005HWV-3x28P | 54.00 | 56.30 |
| A2005HWV-3x9P | 16.00 | 18.30 | A2005HWV-3x29P | 56.00 | 58.30 |
| A2005HWV-3x10P | 18.00 | 20.30 | A2005HWV-3x30P | 58.00 | 60.30 |
| A2005HWV-3x11P | 20.00 | 22.30 | A2005HWV-3x31P | 60.00 | 62.30 |
| A2005HWV-3x12P | 22.00 | 24.30 | A2005HWV-3x32P | 62.00 | 64.30 |
| A2005HWV-3x13P | 24.00 | 26.30 | A2005HWV-3x33P | 64.00 | 66.30 |
| A2005HWV-3x14P | 26.00 | 28.30 | A2005HWV-3x34P | 66.00 | 68.30 |
| A2005HWV-3x15P | 28.00 | 30.30 | A2005HWV-3x35P | 68.00 | 70.30 |
| A2005HWV-3x16P | 30.00 | 32.30 | A2005HWV-3x36P | 70.00 | 72.30 |
| A2005HWV-3x17P | 32.00 | 34.30 | A2005HWV-3x37P | 72.00 | 74.30 |
| A2005HWV-3x18P | 34.00 | 36.30 | A2005HWV-3x38P | 74.00 | 76.30 |
| A2005HWV-3x19P | 36.00 | 38.30 | A2005HWV-3x39P | 76.00 | 78.30 |
| A2005HWV-3x20P | 38.00 | 40.30 | A2005HWV-3x40P | 78.00 | 80.30 |
| A2005HWV-3x21P | 40.00 | 42.30 | | | |

Unit: mm

A2005HWV-4

2.00mm Pitch 180° Four Row Female Header

Reference Informations:

- *Material: Pin: Phosphor Bronze/Gold over Nickel
Insulator: Nylon 6T, UL94V-0
- *Color: Black

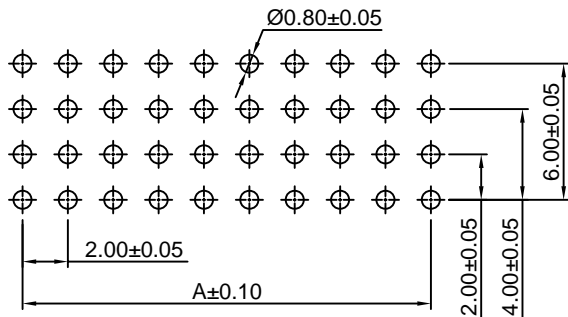
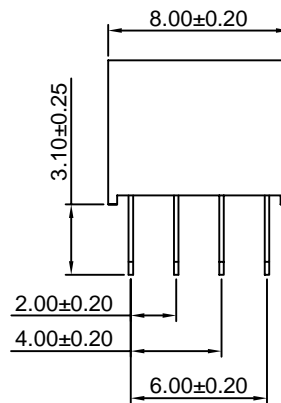
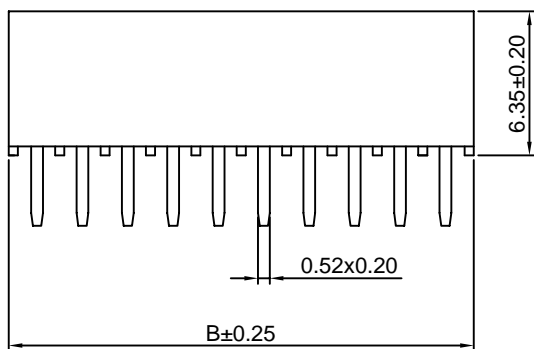
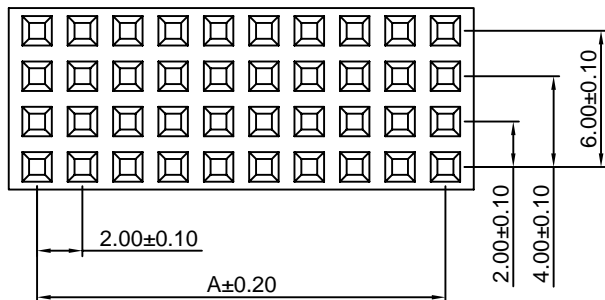
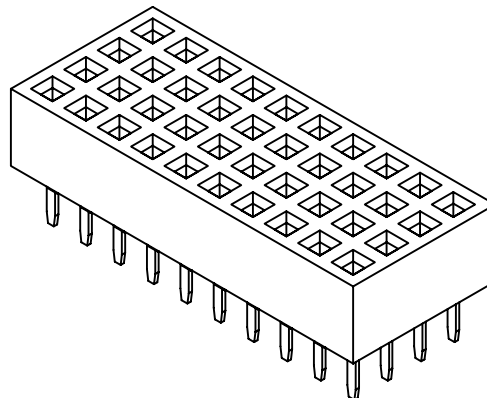

P.C.B LAYOUT

Ordering Information & Dimensions:

| PART NO. | Dimensions | | PART NO. | Dimensions | |
|----------------|------------|-------|----------------|------------|-------|
| | A | B | | A | B |
| A2005HWV-4x2P | 2.00 | 4.30 | A2005HWV-4x22P | 42.00 | 44.30 |
| A2005HWV-4x3P | 4.00 | 6.30 | A2005HWV-4x23P | 44.00 | 46.30 |
| A2005HWV-4x4P | 6.00 | 8.30 | A2005HWV-4x24P | 46.00 | 48.30 |
| A2005HWV-4x5P | 8.00 | 10.30 | A2005HWV-4x25P | 48.00 | 50.30 |
| A2005HWV-4x6P | 10.00 | 12.30 | A2005HWV-4x26P | 50.00 | 52.30 |
| A2005HWV-4x7P | 12.00 | 14.30 | A2005HWV-4x27P | 52.00 | 54.30 |
| A2005HWV-4x8P | 14.00 | 16.30 | A2005HWV-4x28P | 54.00 | 56.30 |
| A2005HWV-4x9P | 16.00 | 18.30 | A2005HWV-4x29P | 56.00 | 58.30 |
| A2005HWV-4x10P | 18.00 | 20.30 | A2005HWV-4x30P | 58.00 | 60.30 |
| A2005HWV-4x11P | 20.00 | 22.30 | A2005HWV-4x31P | 60.00 | 62.30 |
| A2005HWV-4x12P | 22.00 | 24.30 | A2005HWV-4x32P | 62.00 | 64.30 |
| A2005HWV-4x13P | 24.00 | 26.30 | A2005HWV-4x33P | 64.00 | 66.30 |
| A2005HWV-4x14P | 26.00 | 28.30 | A2005HWV-4x34P | 66.00 | 68.30 |
| A2005HWV-4x15P | 28.00 | 30.30 | A2005HWV-4x35P | 68.00 | 70.30 |
| A2005HWV-4x16P | 30.00 | 32.30 | A2005HWV-4x36P | 70.00 | 72.30 |
| A2005HWV-4x17P | 32.00 | 34.30 | A2005HWV-4x37P | 72.00 | 74.30 |
| A2005HWV-4x18P | 34.00 | 36.30 | A2005HWV-4x38P | 74.00 | 76.30 |
| A2005HWV-4x19P | 36.00 | 38.30 | A2005HWV-4x39P | 76.00 | 78.30 |
| A2005HWV-4x20P | 38.00 | 40.30 | A2005HWV-4x40P | 78.00 | 80.30 |
| A2005HWV-4x21P | 40.00 | 42.30 | | | |

Unit: mm

A2005WV

2.00mm pitch 180° Single Row Pin Header

Reference Informations:

- *Material:Pin:Brass/Gold over Nickel
Insulator:Nylon 6T,UL94V-0
- *Mates with CJT A2005 series Single Row Female Header
- *Optional Dim. available but MOQ requested
- *Color:Black

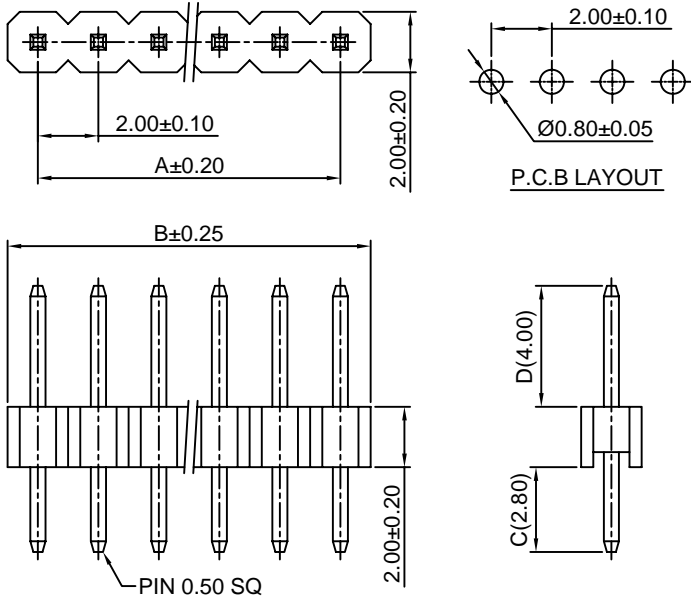

Ordering Information & Dimensions:

| PART NO. | Dimensions | | PART NO. | Dimensions | |
|-------------|------------|-------|-------------|------------|-------|
| | A | B | | A | B |
| A2005WV-2P | 2.00 | 4.00 | A2005WV-22P | 42.00 | 44.00 |
| A2005WV-3P | 4.00 | 6.00 | A2005WV-23P | 44.00 | 46.00 |
| A2005WV-4P | 6.00 | 8.00 | A2005WV-24P | 46.00 | 48.00 |
| A2005WV-5P | 8.00 | 10.00 | A2005WV-25P | 48.00 | 50.00 |
| A2005WV-6P | 10.00 | 12.00 | A2005WV-26P | 50.00 | 52.00 |
| A2005WV-7P | 12.00 | 14.00 | A2005WV-27P | 52.00 | 54.00 |
| A2005WV-8P | 14.00 | 16.00 | A2005WV-28P | 54.00 | 56.00 |
| A2005WV-9P | 16.00 | 18.00 | A2005WV-29P | 56.00 | 58.00 |
| A2005WV-10P | 18.00 | 20.00 | A2005WV-30P | 58.00 | 60.00 |
| A2005WV-11P | 20.00 | 22.00 | A2005WV-31P | 60.00 | 62.00 |
| A2005WV-12P | 22.00 | 24.00 | A2005WV-32P | 62.00 | 64.00 |
| A2005WV-13P | 24.00 | 26.00 | A2005WV-33P | 64.00 | 66.00 |
| A2005WV-14P | 26.00 | 28.00 | A2005WV-34P | 66.00 | 68.00 |
| A2005WV-15P | 28.00 | 30.00 | A2005WV-35P | 68.00 | 70.00 |
| A2005WV-16P | 30.00 | 32.00 | A2005WV-36P | 70.00 | 72.00 |
| A2005WV-17P | 32.00 | 34.00 | A2005WV-37P | 72.00 | 74.00 |
| A2005WV-18P | 34.00 | 36.00 | A2005WV-38P | 74.00 | 76.00 |
| A2005WV-19P | 36.00 | 38.00 | A2005WV-39P | 76.00 | 78.00 |
| A2005WV-20P | 38.00 | 40.00 | A2005WV-40P | 78.00 | 80.00 |
| A2005WV-21P | 40.00 | 42.00 | | | |

Unit: mm

A2005WVA

2.00mm pitch 180° Single Row Pin Header

Reference Informations:

- *Material:Pin:Brass/Gold over Nickel
Insulator:Nylon 6T,UL94V-0
- *Mates with CJT A2005 series Single Row Female Header
- *Optional Dim. available but MOQ requested
- *Color:Black

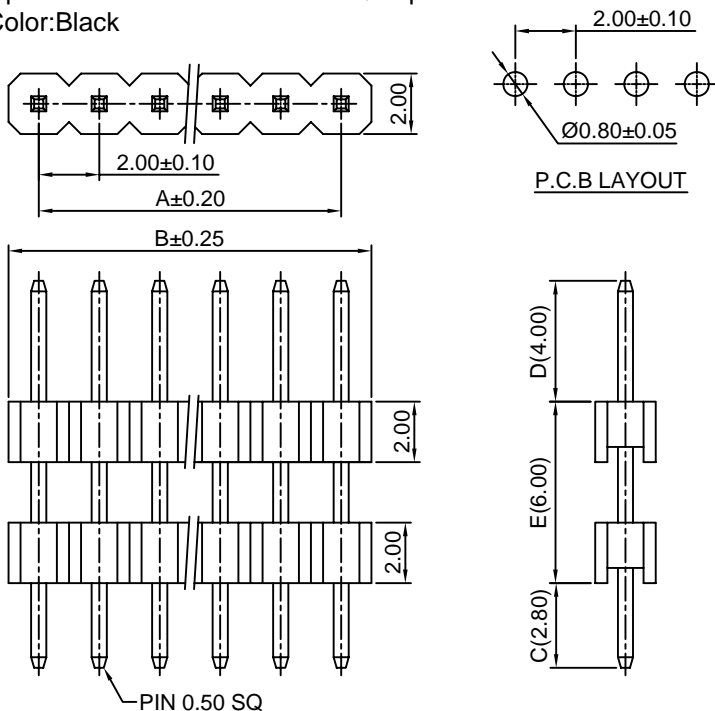

Ordering Information & Dimensions:

| PART NO. | Dimensions | | PART NO. | Dimensions | |
|--------------|------------|-------|--------------|------------|-------|
| | A | B | | A | B |
| A2005WVA-2P | 2.00 | 4.00 | A2005WVA-22P | 42.00 | 44.00 |
| A2005WVA-3P | 4.00 | 6.00 | A2005WVA-23P | 44.00 | 46.00 |
| A2005WVA-4P | 6.00 | 8.00 | A2005WVA-24P | 46.00 | 48.00 |
| A2005WVA-5P | 8.00 | 10.00 | A2005WVA-25P | 48.00 | 50.00 |
| A2005WVA-6P | 10.00 | 12.00 | A2005WVA-26P | 50.00 | 52.00 |
| A2005WVA-7P | 12.00 | 14.00 | A2005WVA-27P | 52.00 | 54.00 |
| A2005WVA-8P | 14.00 | 16.00 | A2005WVA-28P | 54.00 | 56.00 |
| A2005WVA-9P | 16.00 | 18.00 | A2005WVA-29P | 56.00 | 58.00 |
| A2005WVA-10P | 18.00 | 20.00 | A2005WVA-30P | 58.00 | 60.00 |
| A2005WVA-11P | 20.00 | 22.00 | A2005WVA-31P | 60.00 | 62.00 |
| A2005WVA-12P | 22.00 | 24.00 | A2005WVA-32P | 62.00 | 64.00 |
| A2005WVA-13P | 24.00 | 26.00 | A2005WVA-33P | 64.00 | 66.00 |
| A2005WVA-14P | 26.00 | 28.00 | A2005WVA-34P | 66.00 | 68.00 |
| A2005WVA-15P | 28.00 | 30.00 | A2005WVA-35P | 68.00 | 70.00 |
| A2005WVA-16P | 30.00 | 32.00 | A2005WVA-36P | 70.00 | 72.00 |
| A2005WVA-17P | 32.00 | 34.00 | A2005WVA-37P | 72.00 | 74.00 |
| A2005WVA-18P | 34.00 | 36.00 | A2005WVA-38P | 74.00 | 76.00 |
| A2005WVA-19P | 36.00 | 38.00 | A2005WVA-39P | 76.00 | 78.00 |
| A2005WVA-20P | 38.00 | 40.00 | A2005WVA-40P | 78.00 | 80.00 |
| A2005WVA-21P | 40.00 | 42.00 | | | |

Unit: mm

A2005WV-S-A

2.00mm Pitch 180° Single Row Pin Header-SMT TYPE

Reference Informations:

- *Material: Pin: Brass/Gold over Nickel
Insulator: Nylon 6T, UL94V-0
- *Mates with CJT A2005 series Single Row Female Header
- *Optional Dim. available but MOQ requested
- *Color: Black

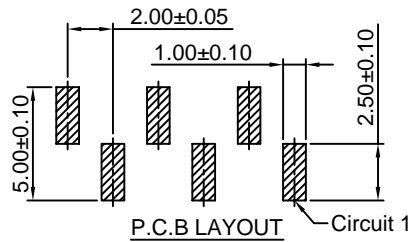
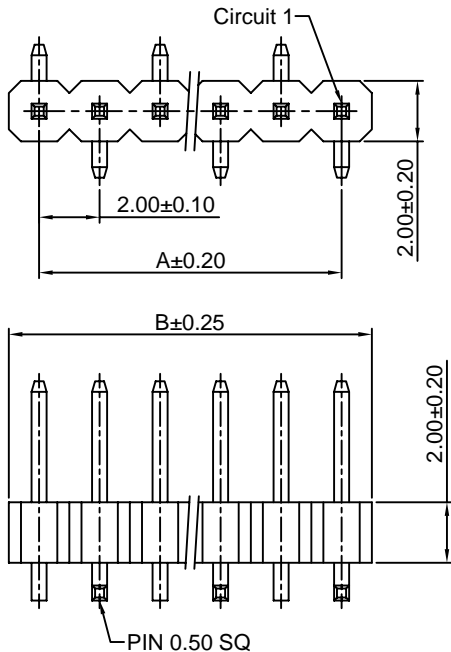

Ordering Information & Dimensions:

| PART NO. | Dimensions | | PART NO. | Dimensions | |
|-----------------|------------|-------|-----------------|------------|-------|
| | A | B | | A | B |
| A2005WV-S-2P-A | 2.00 | 4.00 | A2005WV-S-22P-A | 42.00 | 44.00 |
| A2005WV-S-3P-A | 4.00 | 6.00 | A2005WV-S-23P-A | 44.00 | 46.00 |
| A2005WV-S-4P-A | 6.00 | 8.00 | A2005WV-S-24P-A | 46.00 | 48.00 |
| A2005WV-S-5P-A | 8.00 | 10.00 | A2005WV-S-25P-A | 48.00 | 50.00 |
| A2005WV-S-6P-A | 10.00 | 12.00 | A2005WV-S-26P-A | 50.00 | 52.00 |
| A2005WV-S-7P-A | 12.00 | 14.00 | A2005WV-S-27P-A | 52.00 | 54.00 |
| A2005WV-S-8P-A | 14.00 | 16.00 | A2005WV-S-28P-A | 54.00 | 56.00 |
| A2005WV-S-9P-A | 16.00 | 18.00 | A2005WV-S-29P-A | 56.00 | 58.00 |
| A2005WV-S-10P-A | 18.00 | 20.00 | A2005WV-S-30P-A | 58.00 | 60.00 |
| A2005WV-S-11P-A | 20.00 | 22.00 | A2005WV-S-31P-A | 60.00 | 62.00 |
| A2005WV-S-12P-A | 22.00 | 24.00 | A2005WV-S-32P-A | 62.00 | 64.00 |
| A2005WV-S-13P-A | 24.00 | 26.00 | A2005WV-S-33P-A | 64.00 | 66.00 |
| A2005WV-S-14P-A | 26.00 | 28.00 | A2005WV-S-34P-A | 66.00 | 68.00 |
| A2005WV-S-15P-A | 28.00 | 30.00 | A2005WV-S-35P-A | 68.00 | 70.00 |
| A2005WV-S-16P-A | 30.00 | 32.00 | A2005WV-S-36P-A | 70.00 | 72.00 |
| A2005WV-S-17P-A | 32.00 | 34.00 | A2005WV-S-37P-A | 72.00 | 74.00 |
| A2005WV-S-18P-A | 34.00 | 36.00 | A2005WV-S-38P-A | 74.00 | 76.00 |
| A2005WV-S-19P-A | 36.00 | 38.00 | A2005WV-S-39P-A | 76.00 | 78.00 |
| A2005WV-S-20P-A | 38.00 | 40.00 | A2005WV-S-40P-A | 78.00 | 80.00 |
| A2005WV-S-21P-A | 40.00 | 42.00 | | | |

Unit: mm

A2005WV-S-B

2.00mm Pitch 180° Single Row Pin Header-SMT TYPE

Reference Informations:

- *Material: Pin: Brass/Gold over Nickel
Insulator: Nylon 6T, UL94V-0
- *Mates with CJT A2005 series Single Row Female Header
- *Optional Dim. available but MOQ requested
- *Color: Black

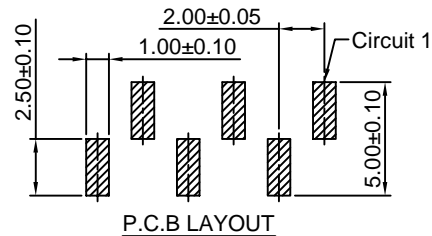
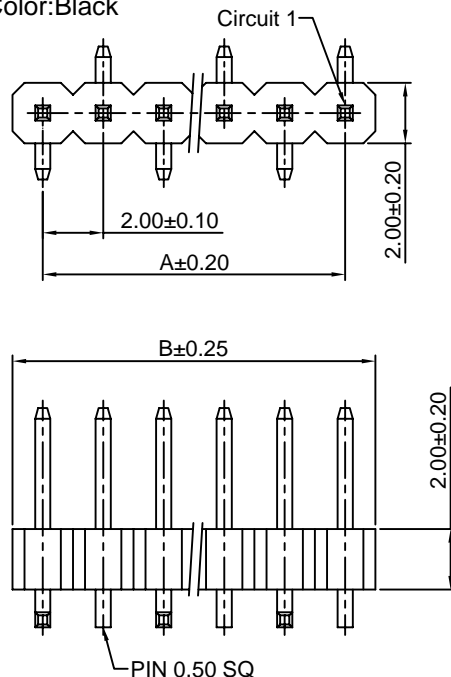

Ordering Information & Dimensions:

| PART NO. | Dimensions | | PART NO. | Dimensions | |
|-----------------|------------|-------|-----------------|------------|-------|
| | A | B | | A | B |
| A2005WV-S-2P-B | 2.00 | 4.00 | A2005WV-S-22P-B | 42.00 | 44.00 |
| A2005WV-S-3P-B | 4.00 | 6.00 | A2005WV-S-23P-B | 44.00 | 46.00 |
| A2005WV-S-4P-B | 6.00 | 8.00 | A2005WV-S-24P-B | 46.00 | 48.00 |
| A2005WV-S-5P-B | 8.00 | 10.00 | A2005WV-S-25P-B | 48.00 | 50.00 |
| A2005WV-S-6P-B | 10.00 | 12.00 | A2005WV-S-26P-B | 50.00 | 52.00 |
| A2005WV-S-7P-B | 12.00 | 14.00 | A2005WV-S-27P-B | 52.00 | 54.00 |
| A2005WV-S-8P-B | 14.00 | 16.00 | A2005WV-S-28P-B | 54.00 | 56.00 |
| A2005WV-S-9P-B | 16.00 | 18.00 | A2005WV-S-29P-B | 56.00 | 58.00 |
| A2005WV-S-10P-B | 18.00 | 20.00 | A2005WV-S-30P-B | 58.00 | 60.00 |
| A2005WV-S-11P-B | 20.00 | 22.00 | A2005WV-S-31P-B | 60.00 | 62.00 |
| A2005WV-S-12P-B | 22.00 | 24.00 | A2005WV-S-32P-B | 62.00 | 64.00 |
| A2005WV-S-13P-B | 24.00 | 26.00 | A2005WV-S-33P-B | 64.00 | 66.00 |
| A2005WV-S-14P-B | 26.00 | 28.00 | A2005WV-S-34P-B | 66.00 | 68.00 |
| A2005WV-S-15P-B | 28.00 | 30.00 | A2005WV-S-35P-B | 68.00 | 70.00 |
| A2005WV-S-16P-B | 30.00 | 32.00 | A2005WV-S-36P-B | 70.00 | 72.00 |
| A2005WV-S-17P-B | 32.00 | 34.00 | A2005WV-S-37P-B | 72.00 | 74.00 |
| A2005WV-S-18P-B | 34.00 | 36.00 | A2005WV-S-38P-B | 74.00 | 76.00 |
| A2005WV-S-19P-B | 36.00 | 38.00 | A2005WV-S-39P-B | 76.00 | 78.00 |
| A2005WV-S-20P-B | 38.00 | 40.00 | A2005WV-S-40P-B | 78.00 | 80.00 |
| A2005WV-S-21P-B | 40.00 | 42.00 | | | |

Unit: mm

A2005WVA-S-A

2.00mm Pitch 180° Single Row Pin Header-SMT A TYPE

Reference Informations:

- *Material: Pin: Brass/Gold over Nickel
Insulator: Nylon 6T, UL94V-0
- *Mates with CJT A2005 series Single Row Female Header
- *Optional Dim. available but MOQ requested
- *Color: Black

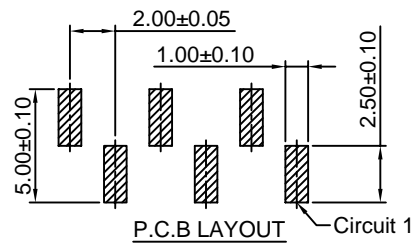
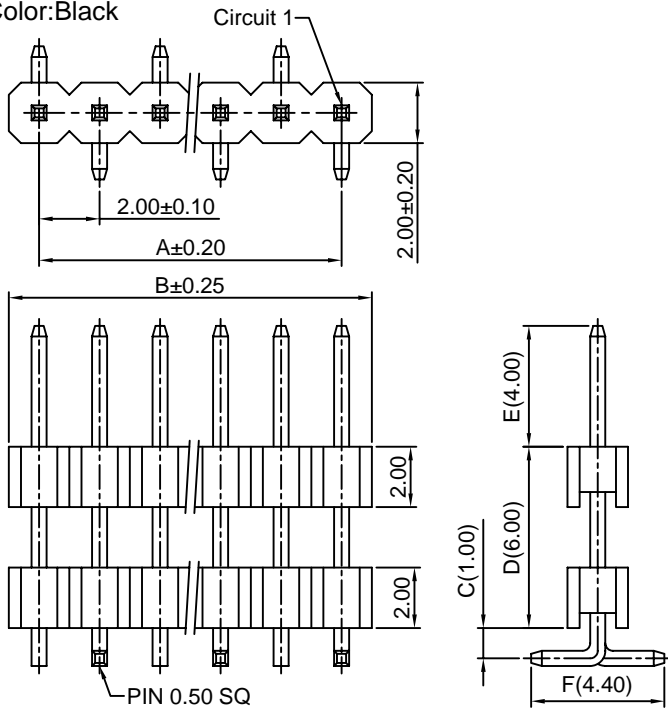

Ordering Information & Dimensions:

| PART NO. | Dimensions | | PART NO. | Dimensions | |
|------------------|------------|-------|------------------|------------|-------|
| | A | B | | A | B |
| A2005WVA-S-2P-A | 2.00 | 4.00 | A2005WVA-S-22P-A | 42.00 | 44.00 |
| A2005WVA-S-3P-A | 4.00 | 6.00 | A2005WVA-S-23P-A | 44.00 | 46.00 |
| A2005WVA-S-4P-A | 6.00 | 8.00 | A2005WVA-S-24P-A | 46.00 | 48.00 |
| A2005WVA-S-5P-A | 8.00 | 10.00 | A2005WVA-S-25P-A | 48.00 | 50.00 |
| A2005WVA-S-6P-A | 10.00 | 12.00 | A2005WVA-S-26P-A | 50.00 | 52.00 |
| A2005WVA-S-7P-A | 12.00 | 14.00 | A2005WVA-S-27P-A | 52.00 | 54.00 |
| A2005WVA-S-8P-A | 14.00 | 16.00 | A2005WVA-S-28P-A | 54.00 | 56.00 |
| A2005WVA-S-9P-A | 16.00 | 18.00 | A2005WVA-S-29P-A | 56.00 | 58.00 |
| A2005WVA-S-10P-A | 18.00 | 20.00 | A2005WVA-S-30P-A | 58.00 | 60.00 |
| A2005WVA-S-11P-A | 20.00 | 22.00 | A2005WVA-S-31P-A | 60.00 | 62.00 |
| A2005WVA-S-12P-A | 22.00 | 24.00 | A2005WVA-S-32P-A | 62.00 | 64.00 |
| A2005WVA-S-13P-A | 24.00 | 26.00 | A2005WVA-S-33P-A | 64.00 | 66.00 |
| A2005WVA-S-14P-A | 26.00 | 28.00 | A2005WVA-S-34P-A | 66.00 | 68.00 |
| A2005WVA-S-15P-A | 28.00 | 30.00 | A2005WVA-S-35P-A | 68.00 | 70.00 |
| A2005WVA-S-16P-A | 30.00 | 32.00 | A2005WVA-S-36P-A | 70.00 | 72.00 |
| A2005WVA-S-17P-A | 32.00 | 34.00 | A2005WVA-S-37P-A | 72.00 | 74.00 |
| A2005WVA-S-18P-A | 34.00 | 36.00 | A2005WVA-S-38P-A | 74.00 | 76.00 |
| A2005WVA-S-19P-A | 36.00 | 38.00 | A2005WVA-S-39P-A | 76.00 | 78.00 |
| A2005WVA-S-20P-A | 38.00 | 40.00 | A2005WVA-S-40P-A | 78.00 | 80.00 |
| A2005WVA-S-21P-A | 40.00 | 42.00 | | | |

Unit: mm

A2005WVA-S-B

2.00mm Pitch 180° Single Row Pin Header-SMT B TYPE

Reference Informations:

- *Material: Pin: Brass/Gold over Nickel
Insulator: Nylon 6T, UL94V-0
- *Mates with CJT A2005 series Single Row Female Header
- *Optional Dim. available but MOQ requested
- *Color: Black

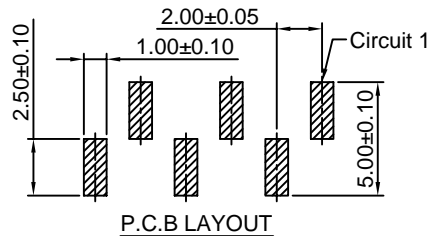
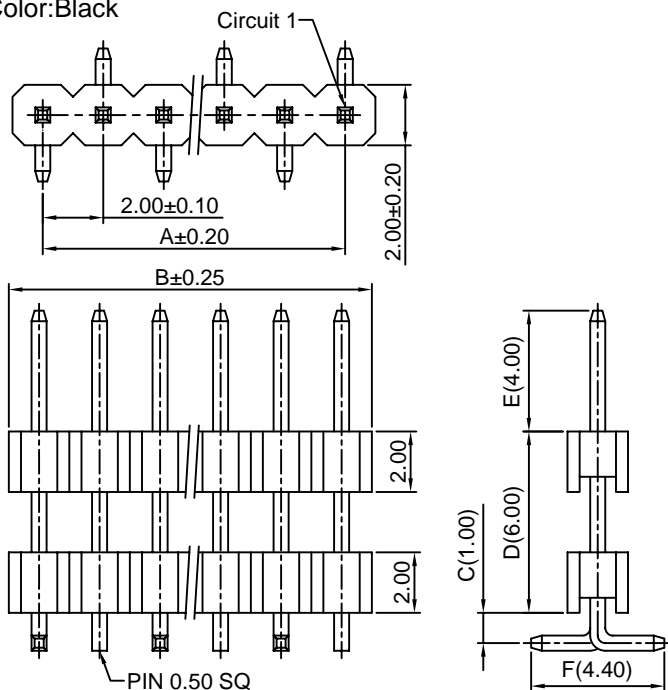

Ordering Information & Dimensions:

| PART NO. | Dimensions | | PART NO. | Dimensions | |
|------------------|------------|-------|------------------|------------|-------|
| | A | B | | A | B |
| A2005WVA-S-2P-B | 2.00 | 4.00 | A2005WVA-S-22P-B | 42.00 | 44.00 |
| A2005WVA-S-3P-B | 4.00 | 6.00 | A2005WVA-S-23P-B | 44.00 | 46.00 |
| A2005WVA-S-4P-B | 6.00 | 8.00 | A2005WVA-S-24P-B | 46.00 | 48.00 |
| A2005WVA-S-5P-B | 8.00 | 10.00 | A2005WVA-S-25P-B | 48.00 | 50.00 |
| A2005WVA-S-6P-B | 10.00 | 12.00 | A2005WVA-S-26P-B | 50.00 | 52.00 |
| A2005WVA-S-7P-B | 12.00 | 14.00 | A2005WVA-S-27P-B | 52.00 | 54.00 |
| A2005WVA-S-8P-B | 14.00 | 16.00 | A2005WVA-S-28P-B | 54.00 | 56.00 |
| A2005WVA-S-9P-B | 16.00 | 18.00 | A2005WVA-S-29P-B | 56.00 | 58.00 |
| A2005WVA-S-10P-B | 18.00 | 20.00 | A2005WVA-S-30P-B | 58.00 | 60.00 |
| A2005WVA-S-11P-B | 20.00 | 22.00 | A2005WVA-S-31P-B | 60.00 | 62.00 |
| A2005WVA-S-12P-B | 22.00 | 24.00 | A2005WVA-S-32P-B | 62.00 | 64.00 |
| A2005WVA-S-13P-B | 24.00 | 26.00 | A2005WVA-S-33P-B | 64.00 | 66.00 |
| A2005WVA-S-14P-B | 26.00 | 28.00 | A2005WVA-S-34P-B | 66.00 | 68.00 |
| A2005WVA-S-15P-B | 28.00 | 30.00 | A2005WVA-S-35P-B | 68.00 | 70.00 |
| A2005WVA-S-16P-B | 30.00 | 32.00 | A2005WVA-S-36P-B | 70.00 | 72.00 |
| A2005WVA-S-17P-B | 32.00 | 34.00 | A2005WVA-S-37P-B | 72.00 | 74.00 |
| A2005WVA-S-18P-B | 34.00 | 36.00 | A2005WVA-S-38P-B | 74.00 | 76.00 |
| A2005WVA-S-19P-B | 36.00 | 38.00 | A2005WVA-S-39P-B | 76.00 | 78.00 |
| A2005WVA-S-20P-B | 38.00 | 40.00 | A2005WVA-S-40P-B | 78.00 | 80.00 |
| A2005WVA-S-21P-B | 40.00 | 42.00 | | | |

Unit: mm

A2005WR

2.00mm pitch 90° Single Row Pin Header

Reference Informations:

- *Material: Pin: Brass/Gold over Nickel
Insulator: Nylon 6T, UL94V-0
- *Mates with CJT A2005 series Single Row Female Header
- *Optional Dim. available but MOQ requested
- *Color: Black

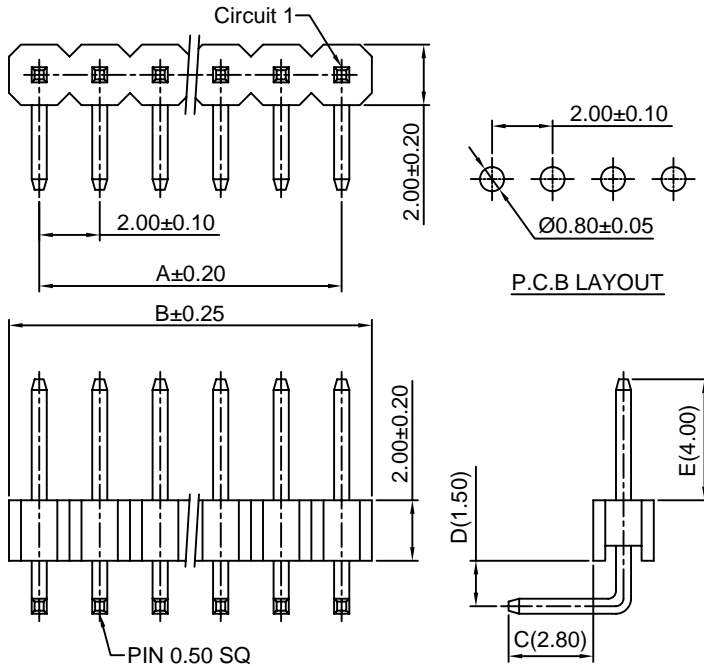

Ordering Information & Dimensions:

| PART NO. | Dimensions | | PART NO. | Dimensions | |
|-------------|------------|-------|-------------|------------|-------|
| | A | B | | A | B |
| A2005WR-2P | 2.00 | 4.00 | A2005WR-22P | 42.00 | 44.00 |
| A2005WR-3P | 4.00 | 6.00 | A2005WR-23P | 44.00 | 46.00 |
| A2005WR-4P | 6.00 | 8.00 | A2005WR-24P | 46.00 | 48.00 |
| A2005WR-5P | 8.00 | 10.00 | A2005WR-25P | 48.00 | 50.00 |
| A2005WR-6P | 10.00 | 12.00 | A2005WR-26P | 50.00 | 52.00 |
| A2005WR-7P | 12.00 | 14.00 | A2005WR-27P | 52.00 | 54.00 |
| A2005WR-8P | 14.00 | 16.00 | A2005WR-28P | 54.00 | 56.00 |
| A2005WR-9P | 16.00 | 18.00 | A2005WR-29P | 56.00 | 58.00 |
| A2005WR-10P | 18.00 | 20.00 | A2005WR-30P | 58.00 | 60.00 |
| A2005WR-11P | 20.00 | 22.00 | A2005WR-31P | 60.00 | 62.00 |
| A2005WR-12P | 22.00 | 24.00 | A2005WR-32P | 62.00 | 64.00 |
| A2005WR-13P | 24.00 | 26.00 | A2005WR-33P | 64.00 | 66.00 |
| A2005WR-14P | 26.00 | 28.00 | A2005WR-34P | 66.00 | 68.00 |
| A2005WR-15P | 28.00 | 30.00 | A2005WR-35P | 68.00 | 70.00 |
| A2005WR-16P | 30.00 | 32.00 | A2005WR-36P | 70.00 | 72.00 |
| A2005WR-17P | 32.00 | 34.00 | A2005WR-37P | 72.00 | 74.00 |
| A2005WR-18P | 34.00 | 36.00 | A2005WR-38P | 74.00 | 76.00 |
| A2005WR-19P | 36.00 | 38.00 | A2005WR-39P | 76.00 | 78.00 |
| A2005WR-20P | 38.00 | 40.00 | A2005WR-40P | 78.00 | 80.00 |
| A2005WR-21P | 40.00 | 42.00 | | | |

Unit: mm

A2005WRA

2.00mm pitch 90° Single Row Pin Header

Reference Informations:

- *Material: Pin: Brass/Gold over Nickel
Insulator: Nylon 6T, UL94V-0
- *Mates with CJT A2005 series Single Row Female Header
- *Optional Dim. available but MOQ requested
- *Color: Black

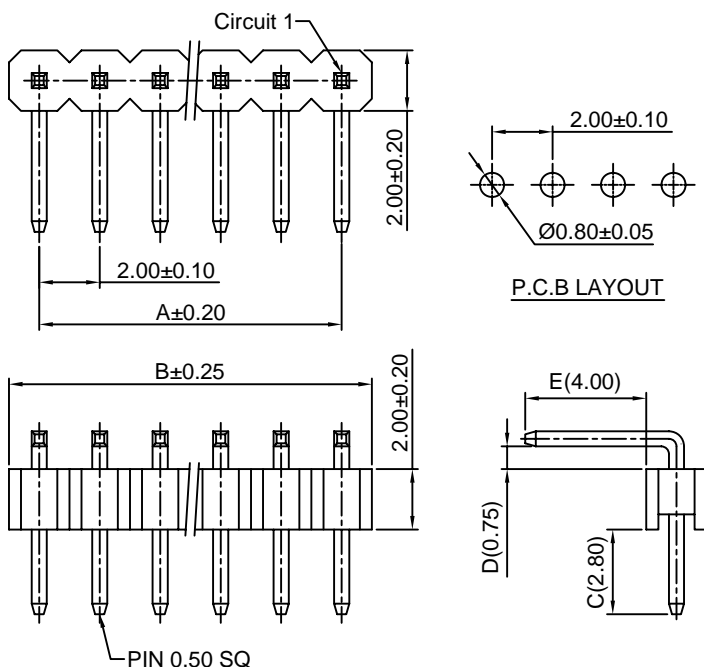

Ordering Information & Dimensions:

| PART NO. | Dimensions | | PART NO. | Dimensions | |
|--------------|------------|-------|--------------|------------|-------|
| | A | B | | A | B |
| A2005WRA-2P | 2.00 | 4.00 | A2005WRA-22P | 42.00 | 44.00 |
| A2005WRA-3P | 4.00 | 6.00 | A2005WRA-23P | 44.00 | 46.00 |
| A2005WRA-4P | 6.00 | 8.00 | A2005WRA-24P | 46.00 | 48.00 |
| A2005WRA-5P | 8.00 | 10.00 | A2005WRA-25P | 48.00 | 50.00 |
| A2005WRA-6P | 10.00 | 12.00 | A2005WRA-26P | 50.00 | 52.00 |
| A2005WRA-7P | 12.00 | 14.00 | A2005WRA-27P | 52.00 | 54.00 |
| A2005WRA-8P | 14.00 | 16.00 | A2005WRA-28P | 54.00 | 56.00 |
| A2005WRA-9P | 16.00 | 18.00 | A2005WRA-29P | 56.00 | 58.00 |
| A2005WRA-10P | 18.00 | 20.00 | A2005WRA-30P | 58.00 | 60.00 |
| A2005WRA-11P | 20.00 | 22.00 | A2005WRA-31P | 60.00 | 62.00 |
| A2005WRA-12P | 22.00 | 24.00 | A2005WRA-32P | 62.00 | 64.00 |
| A2005WRA-13P | 24.00 | 26.00 | A2005WRA-33P | 64.00 | 66.00 |
| A2005WRA-14P | 26.00 | 28.00 | A2005WRA-34P | 66.00 | 68.00 |
| A2005WRA-15P | 28.00 | 30.00 | A2005WRA-35P | 68.00 | 70.00 |
| A2005WRA-16P | 30.00 | 32.00 | A2005WRA-36P | 70.00 | 72.00 |
| A2005WRA-17P | 32.00 | 34.00 | A2005WRA-37P | 72.00 | 74.00 |
| A2005WRA-18P | 34.00 | 36.00 | A2005WRA-38P | 74.00 | 76.00 |
| A2005WRA-19P | 36.00 | 38.00 | A2005WRA-39P | 76.00 | 78.00 |
| A2005WRA-20P | 38.00 | 40.00 | A2005WRA-40P | 78.00 | 80.00 |
| A2005WRA-21P | 40.00 | 42.00 | | | |

Unit: mm

A2005WR-S

2.00mm Pitch 90° Single Row Pin Header-SMT TYPE

Reference Informations:

- *Material: Pin: Brass/Gold over Nickel
Insulator: Nylon 6T, UL94V-0
- *Mates with CJT A2005 series Single Row Female Header
- *Optional Dim. available but MOQ requested
- *Color: Black

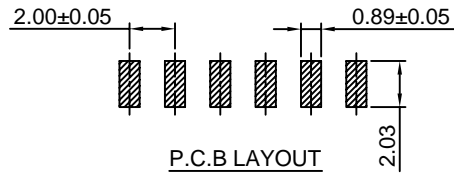
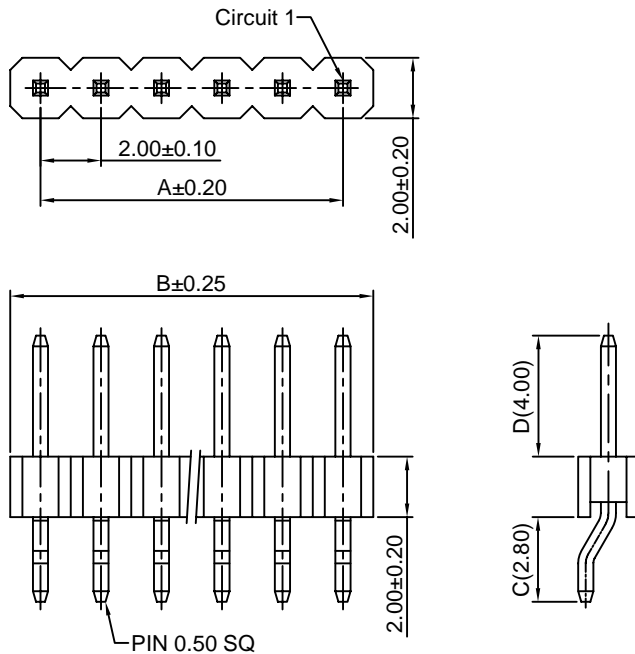

Ordering Information & Dimensions:

| PART NO. | Dimensions | | PART NO. | Dimensions | |
|---------------|------------|-------|---------------|------------|-------|
| | A | B | | A | B |
| A2005WR-S-2P | 2.00 | 4.00 | A2005WR-S-22P | 42.00 | 44.00 |
| A2005WR-S-3P | 4.00 | 6.00 | A2005WR-S-23P | 44.00 | 46.00 |
| A2005WR-S-4P | 6.00 | 8.00 | A2005WR-S-24P | 46.00 | 48.00 |
| A2005WR-S-5P | 8.00 | 10.00 | A2005WR-S-25P | 48.00 | 50.00 |
| A2005WR-S-6P | 10.00 | 12.00 | A2005WR-S-26P | 50.00 | 52.00 |
| A2005WR-S-7P | 12.00 | 14.00 | A2005WR-S-27P | 52.00 | 54.00 |
| A2005WR-S-8P | 14.00 | 16.00 | A2005WR-S-28P | 54.00 | 56.00 |
| A2005WR-S-9P | 16.00 | 18.00 | A2005WR-S-29P | 56.00 | 58.00 |
| A2005WR-S-10P | 18.00 | 20.00 | A2005WR-S-30P | 58.00 | 60.00 |
| A2005WR-S-11P | 20.00 | 22.00 | A2005WR-S-31P | 60.00 | 62.00 |
| A2005WR-S-12P | 22.00 | 24.00 | A2005WR-S-32P | 62.00 | 64.00 |
| A2005WR-S-13P | 24.00 | 26.00 | A2005WR-S-33P | 64.00 | 66.00 |
| A2005WR-S-14P | 26.00 | 28.00 | A2005WR-S-34P | 66.00 | 68.00 |
| A2005WR-S-15P | 28.00 | 30.00 | A2005WR-S-35P | 68.00 | 70.00 |
| A2005WR-S-16P | 30.00 | 32.00 | A2005WR-S-36P | 70.00 | 72.00 |
| A2005WR-S-17P | 32.00 | 34.00 | A2005WR-S-37P | 72.00 | 74.00 |
| A2005WR-S-18P | 34.00 | 36.00 | A2005WR-S-38P | 74.00 | 76.00 |
| A2005WR-S-19P | 36.00 | 38.00 | A2005WR-S-39P | 76.00 | 78.00 |
| A2005WR-S-20P | 38.00 | 40.00 | A2005WR-S-40P | 78.00 | 80.00 |
| A2005WR-S-21P | 40.00 | 42.00 | | | |

Unit: mm

A2005WV-2

2.00mm pitch 180° Dual Row Pin Header

Reference Informations:

- *Material: Pin: Brass/Gold over Nickel
Insulator: Nylon 6T, UL94V-0
- *Mates with CJT A2005 series Dual Row Female Header
- *Optional Dim. available but MOQ requested
- *Color: Black

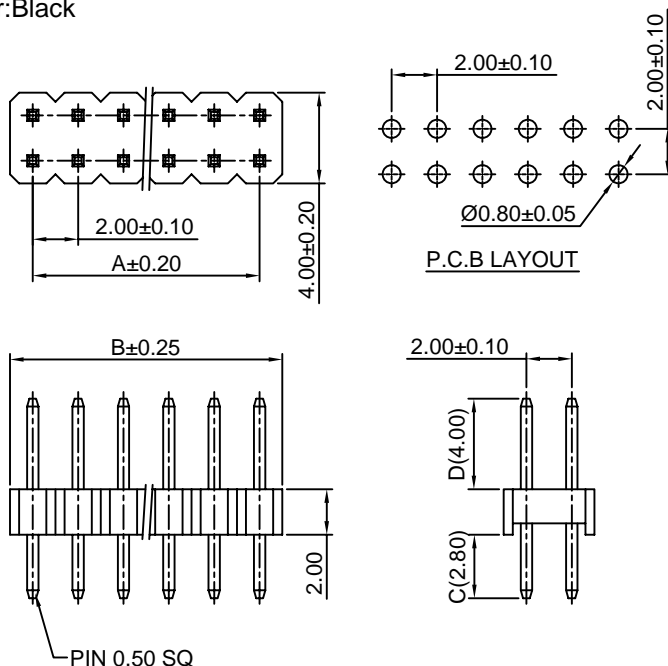

Ordering Information & Dimensions:

| PART NO. | Dimensions | | PART NO. | Dimensions | |
|---------------|------------|-------|---------------|------------|-------|
| | A | B | | A | B |
| A2005WV-2x2P | 2.00 | 4.00 | A2005WV-2x22P | 42.00 | 44.00 |
| A2005WV-2x3P | 4.00 | 6.00 | A2005WV-2x23P | 44.00 | 46.00 |
| A2005WV-2x4P | 6.00 | 8.00 | A2005WV-2x24P | 46.00 | 48.00 |
| A2005WV-2x5P | 8.00 | 10.00 | A2005WV-2x25P | 48.00 | 50.00 |
| A2005WV-2x6P | 10.00 | 12.00 | A2005WV-2x26P | 50.00 | 52.00 |
| A2005WV-2x7P | 12.00 | 14.00 | A2005WV-2x27P | 52.00 | 54.00 |
| A2005WV-2x8P | 14.00 | 16.00 | A2005WV-2x28P | 54.00 | 56.00 |
| A2005WV-2x9P | 16.00 | 18.00 | A2005WV-2x29P | 56.00 | 58.00 |
| A2005WV-2x10P | 18.00 | 20.00 | A2005WV-2x30P | 58.00 | 60.00 |
| A2005WV-2x11P | 20.00 | 22.00 | A2005WV-2x31P | 60.00 | 62.00 |
| A2005WV-2x12P | 22.00 | 24.00 | A2005WV-2x32P | 62.00 | 64.00 |
| A2005WV-2x13P | 24.00 | 26.00 | A2005WV-2x33P | 64.00 | 66.00 |
| A2005WV-2x14P | 26.00 | 28.00 | A2005WV-2x34P | 66.00 | 68.00 |
| A2005WV-2x15P | 28.00 | 30.00 | A2005WV-2x35P | 68.00 | 70.00 |
| A2005WV-2x16P | 30.00 | 32.00 | A2005WV-2x36P | 70.00 | 72.00 |
| A2005WV-2x17P | 32.00 | 34.00 | A2005WV-2x37P | 72.00 | 74.00 |
| A2005WV-2x18P | 34.00 | 36.00 | A2005WV-2x38P | 74.00 | 76.00 |
| A2005WV-2x19P | 36.00 | 38.00 | A2005WV-2x39P | 76.00 | 78.00 |
| A2005WV-2x20P | 38.00 | 40.00 | A2005WV-2x40P | 78.00 | 80.00 |
| A2005WV-2x21P | 40.00 | 42.00 | | | |

Unit: mm

A2005WV-S-2

2.00mm pitch 180° Dual Row Pin Header-SMT TYPE

Reference Informations:

- *Material:Pin:Brass/Gold over Nickel
Insulator:Nylon 6T,UL94V-0
- *Mates with CJT A2005 series Dual Row Female Header
- *Optional Dim. available but MOQ requested
- *Color:Black

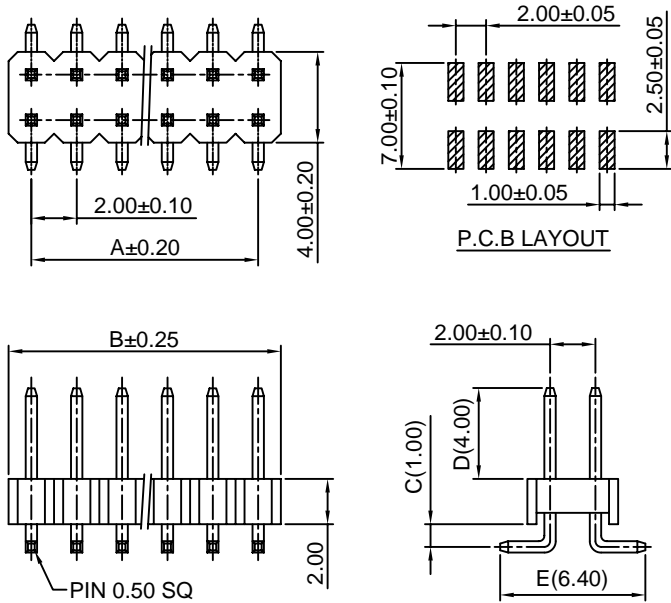

Ordering Information & Dimensions:

| PART NO. | Dimensions | | PART NO. | Dimensions | |
|-----------------|------------|-------|-----------------|------------|-------|
| | A | B | | A | B |
| A2005WV-S-2x2P | 2.00 | 4.00 | A2005WV-S-2x22P | 42.00 | 44.00 |
| A2005WV-S-2x3P | 4.00 | 6.00 | A2005WV-S-2x23P | 44.00 | 46.00 |
| A2005WV-S-2x4P | 6.00 | 8.00 | A2005WV-S-2x24P | 46.00 | 48.00 |
| A2005WV-S-2x5P | 8.00 | 10.00 | A2005WV-S-2x25P | 48.00 | 50.00 |
| A2005WV-S-2x6P | 10.00 | 12.00 | A2005WV-S-2x26P | 50.00 | 52.00 |
| A2005WV-S-2x7P | 12.00 | 14.00 | A2005WV-S-2x27P | 52.00 | 54.00 |
| A2005WV-S-2x8P | 14.00 | 16.00 | A2005WV-S-2x28P | 54.00 | 56.00 |
| A2005WV-S-2x9P | 16.00 | 18.00 | A2005WV-S-2x29P | 56.00 | 58.00 |
| A2005WV-S-2x10P | 18.00 | 20.00 | A2005WV-S-2x30P | 58.00 | 60.00 |
| A2005WV-S-2x11P | 20.00 | 22.00 | A2005WV-S-2x31P | 60.00 | 62.00 |
| A2005WV-S-2x12P | 22.00 | 24.00 | A2005WV-S-2x32P | 62.00 | 64.00 |
| A2005WV-S-2x13P | 24.00 | 26.00 | A2005WV-S-2x33P | 64.00 | 66.00 |
| A2005WV-S-2x14P | 26.00 | 28.00 | A2005WV-S-2x34P | 66.00 | 68.00 |
| A2005WV-S-2x15P | 28.00 | 30.00 | A2005WV-S-2x35P | 68.00 | 70.00 |
| A2005WV-S-2x16P | 30.00 | 32.00 | A2005WV-S-2x36P | 70.00 | 72.00 |
| A2005WV-S-2x17P | 32.00 | 34.00 | A2005WV-S-2x37P | 72.00 | 74.00 |
| A2005WV-S-2x18P | 34.00 | 36.00 | A2005WV-S-2x38P | 74.00 | 76.00 |
| A2005WV-S-2x19P | 36.00 | 38.00 | A2005WV-S-2x39P | 76.00 | 78.00 |
| A2005WV-S-2x20P | 38.00 | 40.00 | A2005WV-S-2x40P | 78.00 | 80.00 |
| A2005WV-S-2x21P | 40.00 | 42.00 | | | |

Unit: mm

A2005WVA-2

2.00mm pitch 180° Dual Row Pin Header

Reference Informations:

- *Material:Pin:Brass/Gold over Nickel
Insulator:Nylon 6T,UL94V-0
- *Mates with CJT A2005 series Dual Row Female Header
- *Optional Dim. available but MOQ requested
- *Color:Black

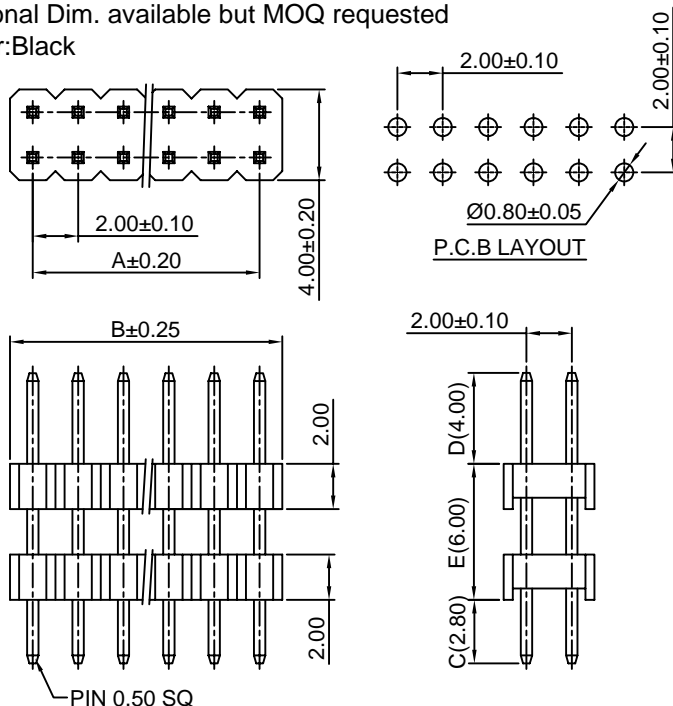

Ordering Information & Dimensions:

| PART NO. | Dimensions | | PART NO. | Dimensions | |
|----------------|------------|-------|----------------|------------|-------|
| | A | B | | A | B |
| A2005WVA-2x2P | 2.00 | 4.00 | A2005WVA-2x22P | 42.00 | 44.00 |
| A2005WVA-2x3P | 4.00 | 6.00 | A2005WVA-2x23P | 44.00 | 46.00 |
| A2005WVA-2x4P | 6.00 | 8.00 | A2005WVA-2x24P | 46.00 | 48.00 |
| A2005WVA-2x5P | 8.00 | 10.00 | A2005WVA-2x25P | 48.00 | 50.00 |
| A2005WVA-2x6P | 10.00 | 12.00 | A2005WVA-2x26P | 50.00 | 52.00 |
| A2005WVA-2x7P | 12.00 | 14.00 | A2005WVA-2x27P | 52.00 | 54.00 |
| A2005WVA-2x8P | 14.00 | 16.00 | A2005WVA-2x28P | 54.00 | 56.00 |
| A2005WVA-2x9P | 16.00 | 18.00 | A2005WVA-2x29P | 56.00 | 58.00 |
| A2005WVA-2x10P | 18.00 | 20.00 | A2005WVA-2x30P | 58.00 | 60.00 |
| A2005WVA-2x11P | 20.00 | 22.00 | A2005WVA-2x31P | 60.00 | 62.00 |
| A2005WVA-2x12P | 22.00 | 24.00 | A2005WVA-2x32P | 62.00 | 64.00 |
| A2005WVA-2x13P | 24.00 | 26.00 | A2005WVA-2x33P | 64.00 | 66.00 |
| A2005WVA-2x14P | 26.00 | 28.00 | A2005WVA-2x34P | 66.00 | 68.00 |
| A2005WVA-2x15P | 28.00 | 30.00 | A2005WVA-2x35P | 68.00 | 70.00 |
| A2005WVA-2x16P | 30.00 | 32.00 | A2005WVA-2x36P | 70.00 | 72.00 |
| A2005WVA-2x17P | 32.00 | 34.00 | A2005WVA-2x37P | 72.00 | 74.00 |
| A2005WVA-2x18P | 34.00 | 36.00 | A2005WVA-2x38P | 74.00 | 76.00 |
| A2005WVA-2x19P | 36.00 | 38.00 | A2005WVA-2x39P | 76.00 | 78.00 |
| A2005WVA-2x20P | 38.00 | 40.00 | A2005WVA-2x40P | 78.00 | 80.00 |
| A2005WVA-2x21P | 40.00 | 42.00 | | | |

Unit: mm

A2005WVA-S-2

2.00mm pitch 180° Dual Row Pin Header - SMT TYPE

Reference Informations:

- *Material: Pin: Brass/Gold over Nickel
Insulator: Nylon 6T, UL94V-0
- *Mates with CJT A2005 series Dual Row Female Header
- *Optional Dim. available but MOQ requested
- *Color: Black



Ordering Information & Dimensions:

| PART NO. | Dimensions | | PART NO. | Dimensions | |
|------------------|------------|-------|------------------|------------|-------|
| | A | B | | A | B |
| A2005WVA-S-2x2P | 2.00 | 4.00 | A2005WVA-S-2x22P | 42.00 | 44.00 |
| A2005WVA-S-2x3P | 4.00 | 6.00 | A2005WVA-S-2x23P | 44.00 | 46.00 |
| A2005WVA-S-2x4P | 6.00 | 8.00 | A2005WVA-S-2x24P | 46.00 | 48.00 |
| A2005WVA-S-2x5P | 8.00 | 10.00 | A2005WVA-S-2x25P | 48.00 | 50.00 |
| A2005WVA-S-2x6P | 10.00 | 12.00 | A2005WVA-S-2x26P | 50.00 | 52.00 |
| A2005WVA-S-2x7P | 12.00 | 14.00 | A2005WVA-S-2x27P | 52.00 | 54.00 |
| A2005WVA-S-2x8P | 14.00 | 16.00 | A2005WVA-S-2x28P | 54.00 | 56.00 |
| A2005WVA-S-2x9P | 16.00 | 18.00 | A2005WVA-S-2x29P | 56.00 | 58.00 |
| A2005WVA-S-2x10P | 18.00 | 20.00 | A2005WVA-S-2x30P | 58.00 | 60.00 |
| A2005WVA-S-2x11P | 20.00 | 22.00 | A2005WVA-S-2x31P | 60.00 | 62.00 |
| A2005WVA-S-2x12P | 22.00 | 24.00 | A2005WVA-S-2x32P | 62.00 | 64.00 |
| A2005WVA-S-2x13P | 24.00 | 26.00 | A2005WVA-S-2x33P | 64.00 | 66.00 |
| A2005WVA-S-2x14P | 26.00 | 28.00 | A2005WVA-S-2x34P | 66.00 | 68.00 |
| A2005WVA-S-2x15P | 28.00 | 30.00 | A2005WVA-S-2x35P | 68.00 | 70.00 |
| A2005WVA-S-2x16P | 30.00 | 32.00 | A2005WVA-S-2x36P | 70.00 | 72.00 |
| A2005WVA-S-2x17P | 32.00 | 34.00 | A2005WVA-S-2x37P | 72.00 | 74.00 |
| A2005WVA-S-2x18P | 34.00 | 36.00 | A2005WVA-S-2x38P | 74.00 | 76.00 |
| A2005WVA-S-2x19P | 36.00 | 38.00 | A2005WVA-S-2x39P | 76.00 | 78.00 |
| A2005WVA-S-2x20P | 38.00 | 40.00 | A2005WVA-S-2x40P | 78.00 | 80.00 |
| A2005WVA-S-2x21P | 40.00 | 42.00 | | | |

Unit: mm

A2005WVA-S-F-2

2.00mm pitch 180° Dual Row Pin Header - SMT TYPE

Reference Informations:

- *Material: Pin: Brass/Gold over Nickel
Insulator: Nylon 6T, UL94V-0
- *Mates with CJT A2005 series Dual Row Female Header
- *Optional Dim. available but MOQ requested
- *Color: Black



Ordering Information & Dimensions:

| PART NO. | Dimensions | | PART NO. | Dimensions | |
|--------------------|------------|-------|--------------------|------------|-------|
| | A | B | | A | B |
| A2005WVA-S-F-2x2P | 2.00 | 4.00 | A2005WVA-S-F-2x22P | 42.00 | 44.00 |
| A2005WVA-S-F-2x3P | 4.00 | 6.00 | A2005WVA-S-F-2x23P | 44.00 | 46.00 |
| A2005WVA-S-F-2x4P | 6.00 | 8.00 | A2005WVA-S-F-2x24P | 46.00 | 48.00 |
| A2005WVA-S-F-2x5P | 8.00 | 10.00 | A2005WVA-S-F-2x25P | 48.00 | 50.00 |
| A2005WVA-S-F-2x6P | 10.00 | 12.00 | A2005WVA-S-F-2x26P | 50.00 | 52.00 |
| A2005WVA-S-F-2x7P | 12.00 | 14.00 | A2005WVA-S-F-2x27P | 52.00 | 54.00 |
| A2005WVA-S-F-2x8P | 14.00 | 16.00 | A2005WVA-S-F-2x28P | 54.00 | 56.00 |
| A2005WVA-S-F-2x9P | 16.00 | 18.00 | A2005WVA-S-F-2x29P | 56.00 | 58.00 |
| A2005WVA-S-F-2x10P | 18.00 | 20.00 | A2005WVA-S-F-2x30P | 58.00 | 60.00 |
| A2005WVA-S-F-2x11P | 20.00 | 22.00 | A2005WVA-S-F-2x31P | 60.00 | 62.00 |
| A2005WVA-S-F-2x12P | 22.00 | 24.00 | A2005WVA-S-F-2x32P | 62.00 | 64.00 |
| A2005WVA-S-F-2x13P | 24.00 | 26.00 | A2005WVA-S-F-2x33P | 64.00 | 66.00 |
| A2005WVA-S-F-2x14P | 26.00 | 28.00 | A2005WVA-S-F-2x34P | 66.00 | 68.00 |
| A2005WVA-S-F-2x15P | 28.00 | 30.00 | A2005WVA-S-F-2x35P | 68.00 | 70.00 |
| A2005WVA-S-F-2x16P | 30.00 | 32.00 | A2005WVA-S-F-2x36P | 70.00 | 72.00 |
| A2005WVA-S-F-2x17P | 32.00 | 34.00 | A2005WVA-S-F-2x37P | 72.00 | 74.00 |
| A2005WVA-S-F-2x18P | 34.00 | 36.00 | A2005WVA-S-F-2x38P | 74.00 | 76.00 |
| A2005WVA-S-F-2x19P | 36.00 | 38.00 | A2005WVA-S-F-2x39P | 76.00 | 78.00 |
| A2005WVA-S-F-2x20P | 38.00 | 40.00 | A2005WVA-S-F-2x40P | 78.00 | 80.00 |
| A2005WVA-S-F-2x21P | 40.00 | 42.00 | | | |

Unit: mm

A2005WR-2

2.00mm pitch 90° Dual Row Pin Header

Reference Informations:

- *Material: Pin: Brass/Gold over Nickel
Insulator: Nylon 6T, UL94V-0
- *Mates with CJT A2005 series Dual Row Female Header
- *Optional Dim. available but MOQ requested
- *Color: Black

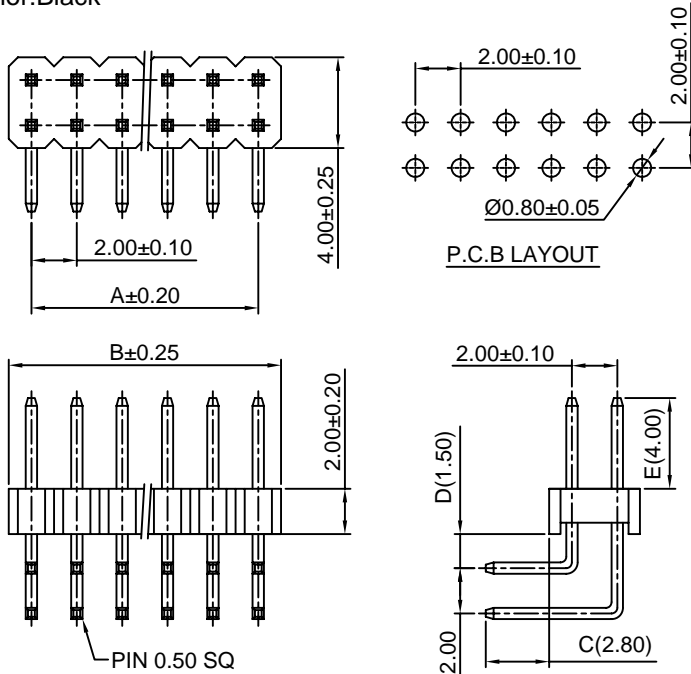

Ordering Information & Dimensions:

| PART NO. | Dimensions | | PART NO. | Dimensions | |
|---------------|------------|-------|---------------|------------|-------|
| | A | B | | A | B |
| A2005WR-2x2P | 2.00 | 4.00 | A2005WR-2x22P | 42.00 | 44.00 |
| A2005WR-2x3P | 4.00 | 6.00 | A2005WR-2x23P | 44.00 | 46.00 |
| A2005WR-2x4P | 6.00 | 8.00 | A2005WR-2x24P | 46.00 | 48.00 |
| A2005WR-2x5P | 8.00 | 10.00 | A2005WR-2x25P | 48.00 | 50.00 |
| A2005WR-2x6P | 10.00 | 12.00 | A2005WR-2x26P | 50.00 | 52.00 |
| A2005WR-2x7P | 12.00 | 14.00 | A2005WR-2x27P | 52.00 | 54.00 |
| A2005WR-2x8P | 14.00 | 16.00 | A2005WR-2x28P | 54.00 | 56.00 |
| A2005WR-2x9P | 16.00 | 18.00 | A2005WR-2x29P | 56.00 | 58.00 |
| A2005WR-2x10P | 18.00 | 20.00 | A2005WR-2x30P | 58.00 | 60.00 |
| A2005WR-2x11P | 20.00 | 22.00 | A2005WR-2x31P | 60.00 | 62.00 |
| A2005WR-2x12P | 22.00 | 24.00 | A2005WR-2x32P | 62.00 | 64.00 |
| A2005WR-2x13P | 24.00 | 26.00 | A2005WR-2x33P | 64.00 | 66.00 |
| A2005WR-2x14P | 26.00 | 28.00 | A2005WR-2x34P | 66.00 | 68.00 |
| A2005WR-2x15P | 28.00 | 30.00 | A2005WR-2x35P | 68.00 | 70.00 |
| A2005WR-2x16P | 30.00 | 32.00 | A2005WR-2x36P | 70.00 | 72.00 |
| A2005WR-2x17P | 32.00 | 34.00 | A2005WR-2x37P | 72.00 | 74.00 |
| A2005WR-2x18P | 34.00 | 36.00 | A2005WR-2x38P | 74.00 | 76.00 |
| A2005WR-2x19P | 36.00 | 38.00 | A2005WR-2x39P | 76.00 | 78.00 |
| A2005WR-2x20P | 38.00 | 40.00 | A2005WR-2x40P | 78.00 | 80.00 |
| A2005WR-2x21P | 40.00 | 42.00 | | | |

Unit: mm

A2005WR-S-2

2.00mm pitch 90° Dual Row Pin Header-SMT TYPE

Reference Informations:

- *Material: Pin: Brass/Gold over Nickel
Insulator: Nylon 6T, UL94V-0
- *Mates with CJT A2005 series Dual Row Female Header
- *Optional Dim. available but MOQ requested
- *Color: Black

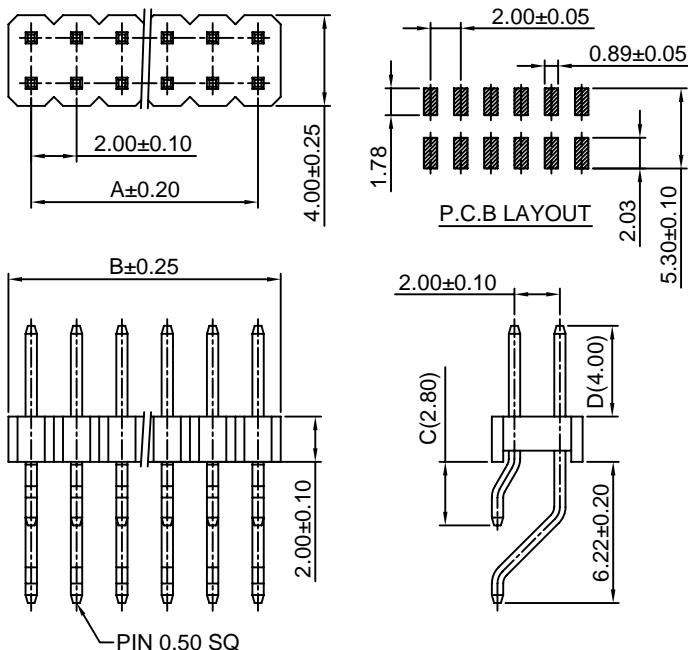
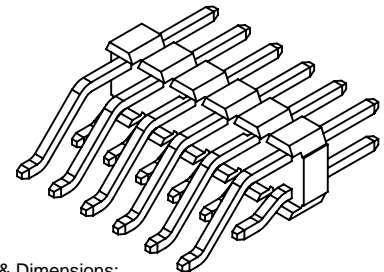

Ordering Information & Dimensions:

| PART NO. | Dimensions | | PART NO. | Dimensions | |
|-----------------|------------|-------|-----------------|------------|-------|
| | A | B | | A | B |
| A2005WR-S-2x2P | 2.00 | 4.00 | A2005WR-S-2x22P | 42.00 | 44.00 |
| A2005WR-S-2x3P | 4.00 | 6.00 | A2005WR-S-2x23P | 44.00 | 46.00 |
| A2005WR-S-2x4P | 6.00 | 8.00 | A2005WR-S-2x24P | 46.00 | 48.00 |
| A2005WR-S-2x5P | 8.00 | 10.00 | A2005WR-S-2x25P | 48.00 | 50.00 |
| A2005WR-S-2x6P | 10.00 | 12.00 | A2005WR-S-2x26P | 50.00 | 52.00 |
| A2005WR-S-2x7P | 12.00 | 14.00 | A2005WR-S-2x27P | 52.00 | 54.00 |
| A2005WR-S-2x8P | 14.00 | 16.00 | A2005WR-S-2x28P | 54.00 | 56.00 |
| A2005WR-S-2x9P | 16.00 | 18.00 | A2005WR-S-2x29P | 56.00 | 58.00 |
| A2005WR-S-2x10P | 18.00 | 20.00 | A2005WR-S-2x30P | 58.00 | 60.00 |
| A2005WR-S-2x11P | 20.00 | 22.00 | A2005WR-S-2x31P | 60.00 | 62.00 |
| A2005WR-S-2x12P | 22.00 | 24.00 | A2005WR-S-2x32P | 62.00 | 64.00 |
| A2005WR-S-2x13P | 24.00 | 26.00 | A2005WR-S-2x33P | 64.00 | 66.00 |
| A2005WR-S-2x14P | 26.00 | 28.00 | A2005WR-S-2x34P | 66.00 | 68.00 |
| A2005WR-S-2x15P | 28.00 | 30.00 | A2005WR-S-2x35P | 68.00 | 70.00 |
| A2005WR-S-2x16P | 30.00 | 32.00 | A2005WR-S-2x36P | 70.00 | 72.00 |
| A2005WR-S-2x17P | 32.00 | 34.00 | A2005WR-S-2x37P | 72.00 | 74.00 |
| A2005WR-S-2x18P | 34.00 | 36.00 | A2005WR-S-2x38P | 74.00 | 76.00 |
| A2005WR-S-2x19P | 36.00 | 38.00 | A2005WR-S-2x39P | 76.00 | 78.00 |
| A2005WR-S-2x20P | 38.00 | 40.00 | A2005WR-S-2x40P | 78.00 | 80.00 |
| A2005WR-S-2x21P | 40.00 | 42.00 | | | |

Unit: mm

A2005WRB-2

2.00mm pitch 90° Dual Row Pin Header

Reference Informations:

- *Material: Pin: Brass/Gold over Nickel
Insulator: Nylon 6T, UL94V-0
- *Mates with CJT A2005 series Dual Row Female Header
- *Optional Dim. available but MOQ requested
- *Color: Black



Ordering Information & Dimensions:

| PART NO. | Dimensions | | PART NO. | Dimensions | |
|----------------|------------|-------|----------------|------------|-------|
| | A | B | | A | B |
| A2005WRB-2x2P | 2.00 | 4.00 | A2005WRB-2x22P | 42.00 | 44.00 |
| A2005WRB-2x3P | 4.00 | 6.00 | A2005WRB-2x23P | 44.00 | 46.00 |
| A2005WRB-2x4P | 6.00 | 8.00 | A2005WRB-2x24P | 46.00 | 48.00 |
| A2005WRB-2x5P | 8.00 | 10.00 | A2005WRB-2x25P | 48.00 | 50.00 |
| A2005WRB-2x6P | 10.00 | 12.00 | A2005WRB-2x26P | 50.00 | 52.00 |
| A2005WRB-2x7P | 12.00 | 14.00 | A2005WRB-2x27P | 52.00 | 54.00 |
| A2005WRB-2x8P | 14.00 | 16.00 | A2005WRB-2x28P | 54.00 | 56.00 |
| A2005WRB-2x9P | 16.00 | 18.00 | A2005WRB-2x29P | 56.00 | 58.00 |
| A2005WRB-2x10P | 18.00 | 20.00 | A2005WRB-2x30P | 58.00 | 60.00 |
| A2005WRB-2x11P | 20.00 | 22.00 | A2005WRB-2x31P | 60.00 | 62.00 |
| A2005WRB-2x12P | 22.00 | 24.00 | A2005WRB-2x32P | 62.00 | 64.00 |
| A2005WRB-2x13P | 24.00 | 26.00 | A2005WRB-2x33P | 64.00 | 66.00 |
| A2005WRB-2x14P | 26.00 | 28.00 | A2005WRB-2x34P | 66.00 | 68.00 |
| A2005WRB-2x15P | 28.00 | 30.00 | A2005WRB-2x35P | 68.00 | 70.00 |
| A2005WRB-2x16P | 30.00 | 32.00 | A2005WRB-2x36P | 70.00 | 72.00 |
| A2005WRB-2x17P | 32.00 | 34.00 | A2005WRB-2x37P | 72.00 | 74.00 |
| A2005WRB-2x18P | 34.00 | 36.00 | A2005WRB-2x38P | 74.00 | 76.00 |
| A2005WRB-2x19P | 36.00 | 38.00 | A2005WRB-2x39P | 76.00 | 78.00 |
| A2005WRB-2x20P | 38.00 | 40.00 | A2005WRB-2x40P | 78.00 | 80.00 |
| A2005WRB-2x21P | 40.00 | 42.00 | | | |

Unit: mm

X-ON Electronics

Largest Supplier of Electrical and Electronic Components

Click to view similar products for [Headers & Wire Housings](#) category:

Click to view products by [Changjiang](#) manufacturer:

Other Similar products are found below :

[57102-F02-18ULF](#) [58102-G61-06LF](#) [0009485154](#) [009176003701906](#) [0050291907](#) [00-9021-0611-00-339](#) [02.125.8002.8](#) [609-3404](#) [61062-3](#)
[622-0430](#) [622-3653LF](#) [63453-116](#) [636-1030](#) [636-1427](#) [636-3427](#) [636-4007](#) [641938-9](#) [644827-2](#) [65495-038](#) [65692-001LF](#) [65781-018](#)
[65781-047](#) [65817-010LF](#) [65817-015LF](#) [66207-023LF](#) [67016-026LF](#) [67095-007LF](#) [68631-112](#) [68645-018](#) [68648-049](#) [699319-000](#)
[70.362.1628.0](#) [70-4210](#) [70-4226B](#) [70-4853B](#) [707-5020](#) [707-5028](#) [71.350.2428.0](#) [71961-016LF](#) [733-134](#) [754199-000](#) [760-3052](#) [787-8014-00](#)
[FCN-367T-T012/H](#) [80.063.4001.1](#) [800-90-001-10-001000](#) [800-90-010-10-002000](#) [801-43-002-10-013000](#) [801-43-006-10-002000](#)
[803-41-018-10-001000](#)