

Specifications

- Current rating: 2A AC, DC
- Voltage rating: 250V AC, DC
- Temperature range: -40°C ~ +105°C
- Contact resistance: 20mΩ Max.
- Insulation resistance: 1000MΩ Min.
- Withstanding voltage: 500V AC/minute
- *Compliant with RoHS and REACH*
- *Meet the HF/Halogen Free, need to customize*
- *Contact CJT for details*

Standards

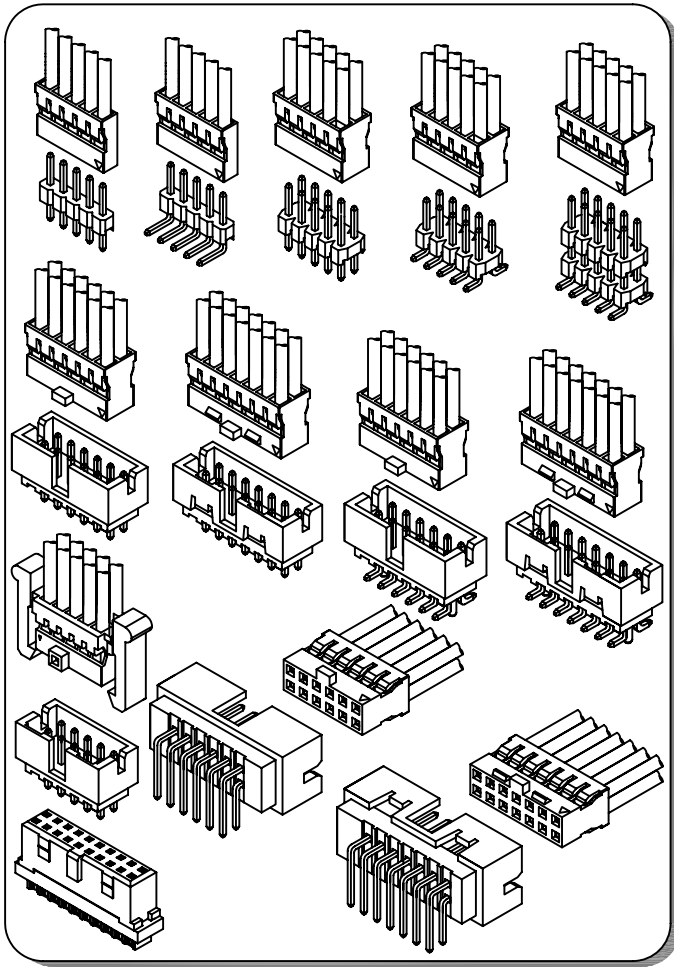

Assembly layout

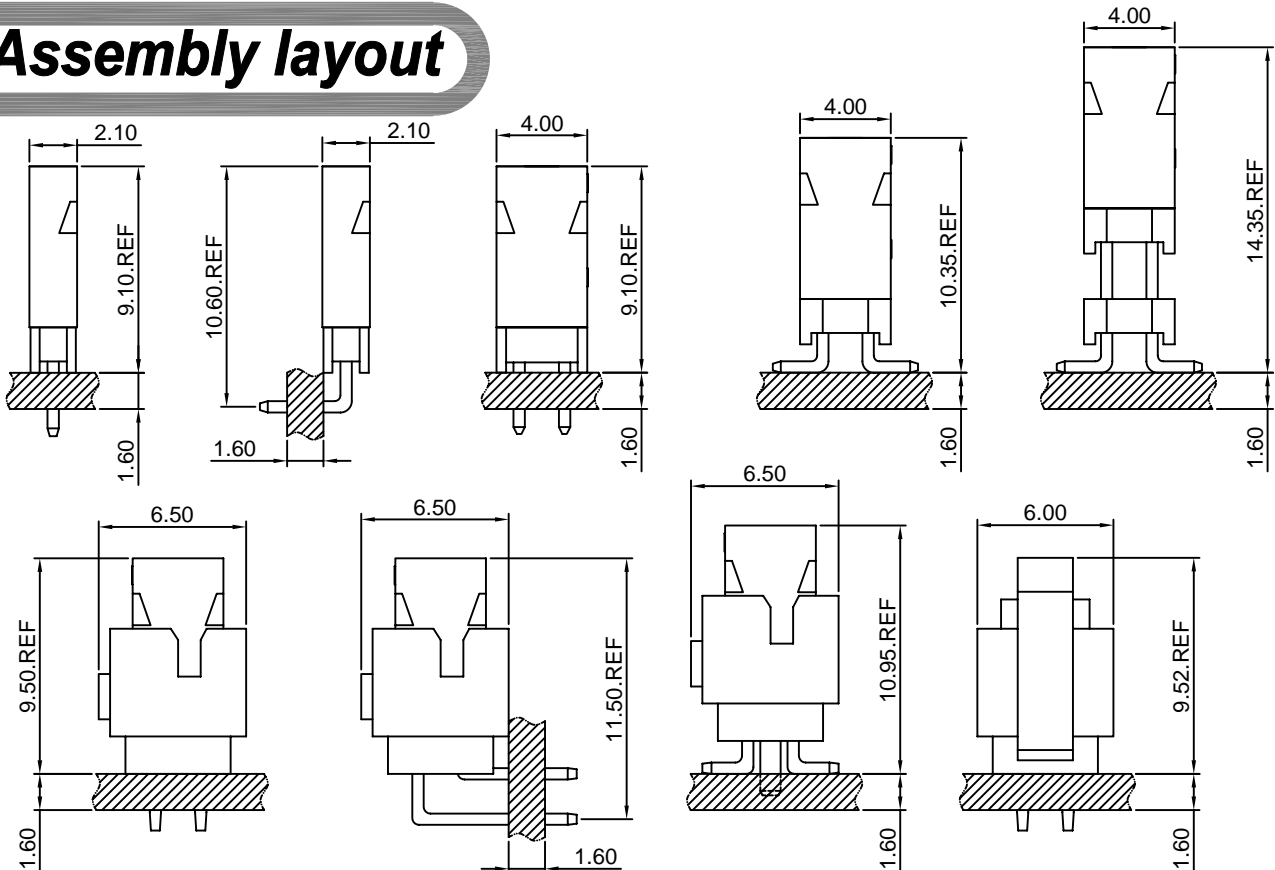

A2005-T

2.00mm pitch Crimp Terminal

Reference Informations:

*Used in CJT A2005 series Housing

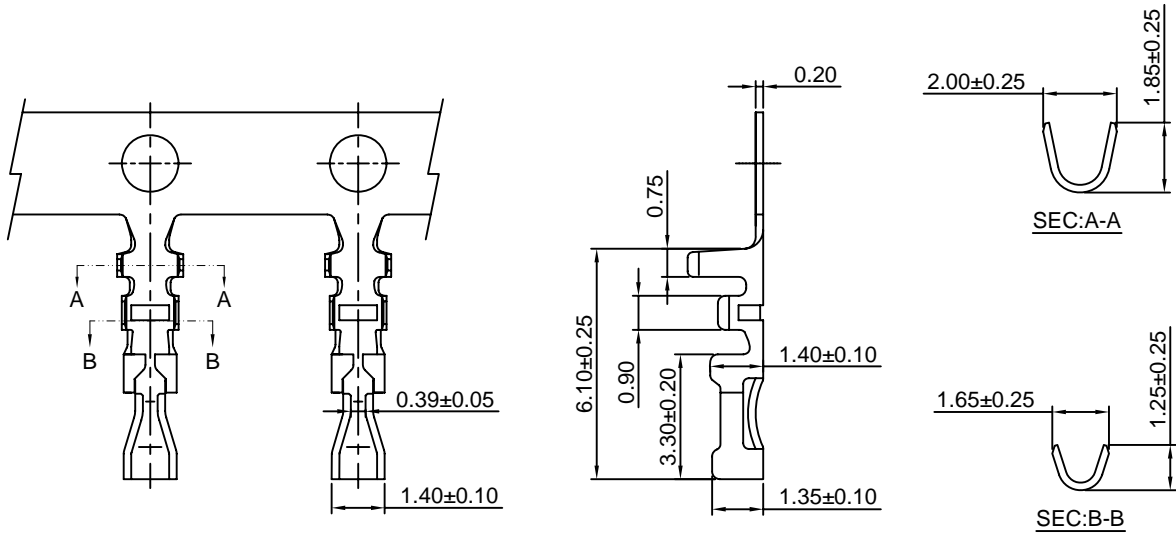

Ordering information & Specifications:

Unit:mm

Part NO.	Wire Range	Insulation O.D.	Material	Finish	Qty/reel
A2005-TP	AWG#26-#30	1.40mm(max)	Phosphor Bronze	Tin over Nickel	10,000 PCS
A2005-GP	AWG#26-#30	1.40mm(max)	Phosphor Bronze	Gold over Nickel	10,000 PCS

Optional Gold plating available but MOQ requested

A2005-T-B

2.00mm pitch Crimp Terminal

Reference Informations:

*Used in CJT A2005 series Housing

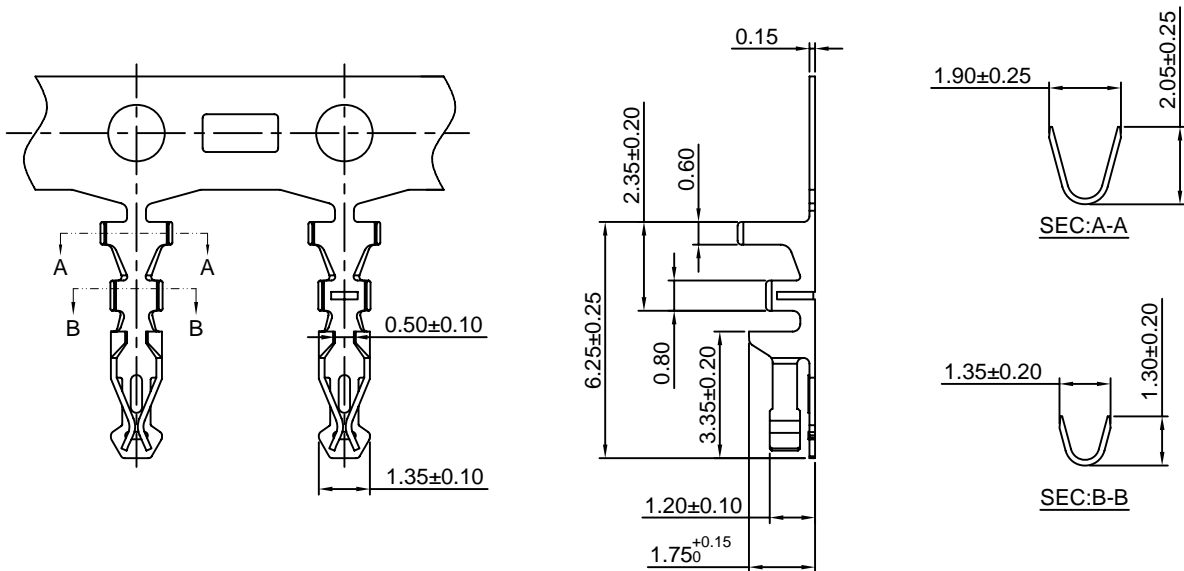

Ordering information & Specifications:

Unit:mm

Part NO.	Wire Range	Insulation O.D.	Material	Finish	Qty/reel
A2005-GP-B	AWG#24-#30	1.40mm(max)	Phosphor Bronze	Gold over Nickel	10,000 PCS

A2005H

2.00mm pitch Single Row Housing

Reference Informations:

- *Material:PBT,UL94V-0
- *Suitable CJT A2005 series Terminal
- *Mates with CJT A2005 series Single Row Wafer
- *Color:Black

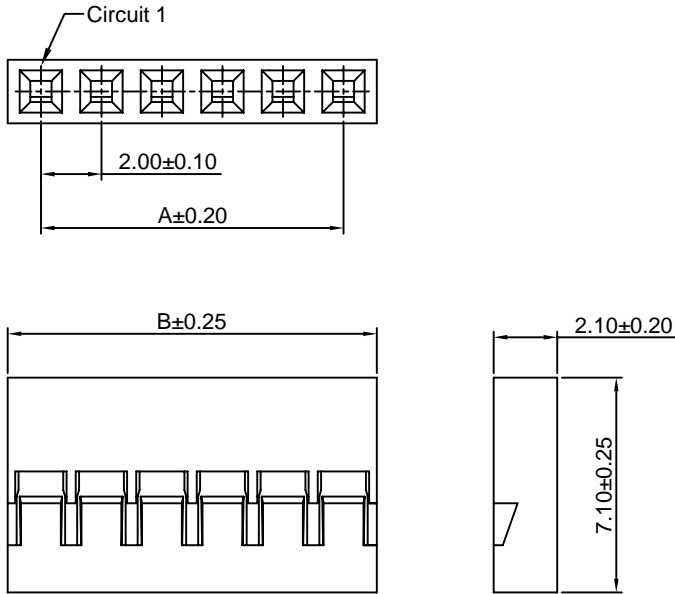
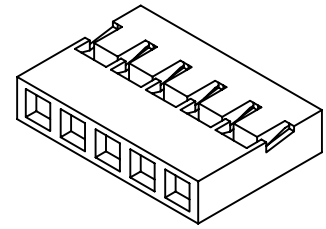

Ordering Information & Dimensions:

PART NO.	Dimensions		PART NO.	Dimensions	
	A	B		A	B
A2005H-2P	2.00	4.20	A2005H-22P	42.00	44.20
A2005H-3P	4.00	6.20	A2005H-23P	44.00	46.20
A2005H-4P	6.00	8.20	A2005H-24P	46.00	48.20
A2005H-5P	8.00	10.20	A2005H-25P	48.00	50.20
A2005H-6P	10.00	12.20	A2005H-26P	50.00	52.20
A2005H-7P	12.00	14.20	A2005H-27P	52.00	54.20
A2005H-8P	14.00	16.20	A2005H-28P	54.00	56.20
A2005H-9P	16.00	18.20	A2005H-29P	56.00	58.20
A2005H-10P	18.00	20.20	A2005H-30P	58.00	60.20
A2005H-11P	20.00	22.20	A2005H-31P	60.00	62.20
A2005H-12P	22.00	24.20	A2005H-32P	62.00	64.20
A2005H-13P	24.00	26.20	A2005H-33P	64.00	66.20
A2005H-14P	26.00	28.20	A2005H-34P	66.00	68.20
A2005H-15P	28.00	30.20	A2005H-35P	68.00	70.20
A2005H-16P	30.00	32.20	A2005H-36P	70.00	72.20
A2005H-17P	32.00	34.20	A2005H-37P	72.00	74.20
A2005H-18P	34.00	36.20	A2005H-38P	74.00	76.20
A2005H-19P	36.00	38.20	A2005H-39P	76.00	78.20
A2005H-20P	38.00	40.20	A2005H-40P	78.00	80.20
A2005H-21P	40.00	42.20			

Unit: mm

A2005H-N

2.00mm pitch Single Row Housing

Reference Informations:

- *Material:PBT,UL94V-0
- *Suitable CJT A2005 series Terminal
- *Mates with CJT A2005 series Single Row Wafer
- *Color:Black

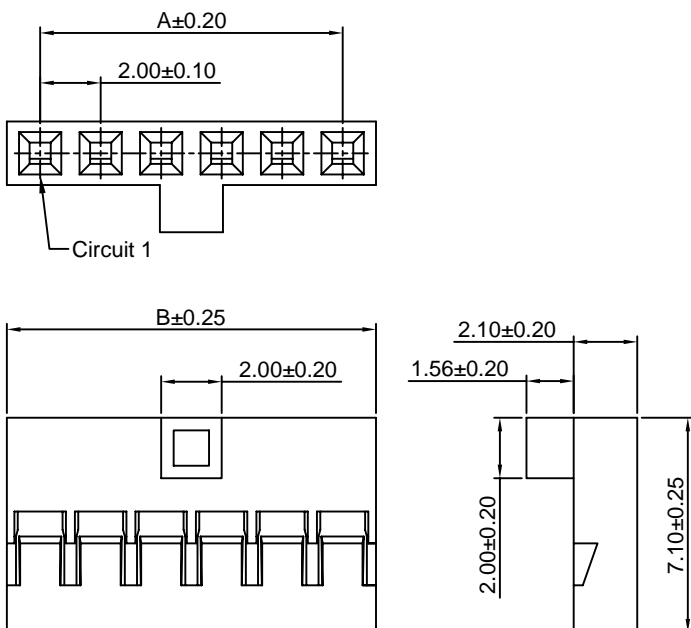
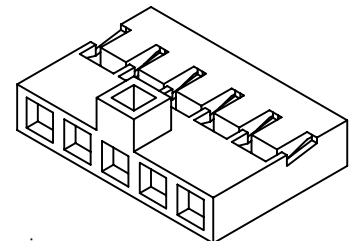

Ordering Information & Dimensions:

PART NO.	Dimensions		PART NO.	Dimensions	
	A	B		A	B
A2005H-N-2P	2.00	4.20	A2005H-N-22P	42.00	44.20
A2005H-N-3P	4.00	6.20	A2005H-N-23P	44.00	46.20
A2005H-N-4P	6.00	8.20	A2005H-N-24P	46.00	48.20
A2005H-N-5P	8.00	10.20	A2005H-N-25P	48.00	50.20
A2005H-N-6P	10.00	12.20	A2005H-N-26P	50.00	52.20
A2005H-N-7P	12.00	14.20	A2005H-N-27P	52.00	54.20
A2005H-N-8P	14.00	16.20	A2005H-N-28P	54.00	56.20
A2005H-N-9P	16.00	18.20	A2005H-N-29P	56.00	58.20
A2005H-N-10P	18.00	20.20	A2005H-N-30P	58.00	60.20
A2005H-N-11P	20.00	22.20	A2005H-N-31P	60.00	62.20
A2005H-N-12P	22.00	24.20	A2005H-N-32P	62.00	64.20
A2005H-N-13P	24.00	26.20	A2005H-N-33P	64.00	66.20
A2005H-N-14P	26.00	28.20	A2005H-N-34P	66.00	68.20
A2005H-N-15P	28.00	30.20	A2005H-N-35P	68.00	70.20
A2005H-N-16P	30.00	32.20	A2005H-N-36P	70.00	72.20
A2005H-N-17P	32.00	34.20	A2005H-N-37P	72.00	74.20
A2005H-N-18P	34.00	36.20	A2005H-N-38P	74.00	76.20
A2005H-N-19P	36.00	38.20	A2005H-N-39P	76.00	78.20
A2005H-N-20P	38.00	40.20	A2005H-N-40P	78.00	80.20
A2005H-N-21P	40.00	42.20			

Unit: mm

A2005HB-N-FI

2.00mm pitch Single Row Housing

Reference Informations:

- *Material:Nylon 66,UL94V-0
- *Suitable CJT A2005 series Terminal
- *Mates with CJT A2005 series Single Row Wafer
- *Color:White

Ordering Information:
A2005HB-N-XP-FI - **
 1 2
 1.Part No.
 2.Color:
 (blank) - White
 BK - Black

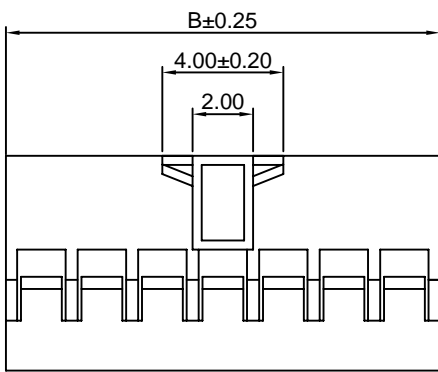
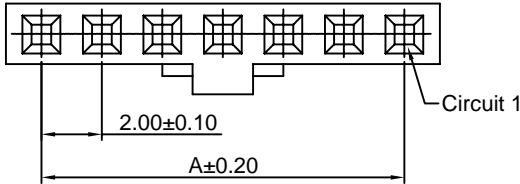
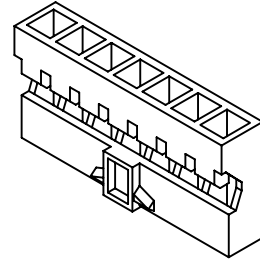

2x3P~2x17P

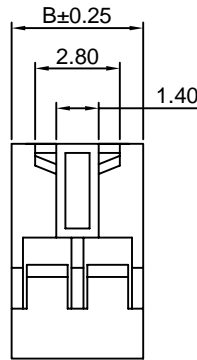
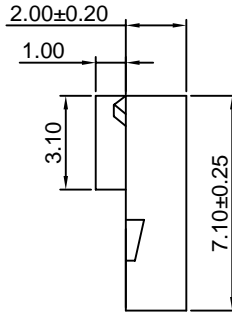

2x2P

Ordering Information & Dimensions:

PART NO.	Dimensions	
	A	B
A2005HB-N-2P-FI	2.00	4.35
A2005HB-N-3P-FI	4.00	6.35
A2005HB-N-4P-FI	6.00	8.35
A2005HB-N-5P-FI	8.00	10.35
A2005HB-N-6P-FI	10.00	12.35
A2005HB-N-7P-FI	12.00	14.35
A2005HB-N-8P-FI	14.00	16.35
A2005HB-N-9P-FI	16.00	18.35
A2005HB-N-10P-FI	18.00	20.35
A2005HB-N-11P-FI	20.00	22.35
A2005HB-N-12P-FI	22.00	24.35
A2005HB-N-13P-FI	24.00	26.35
A2005HB-N-14P-FI	26.00	28.35
A2005HB-N-15P-FI	28.00	30.35
A2005HB-N-16P-FI	30.00	32.35
A2005HB-N-17P-FI	32.00	34.35

Unit: mm

A2005H-2

2.00mm Pitch Dual Row Housing

Reference Informations:

- *Material:PBT,UL94V-0
- *Suitable CJT A2005 series Terminal
- *Mates with CJT A2005 series Dual Row Wafer
- *Color:Black

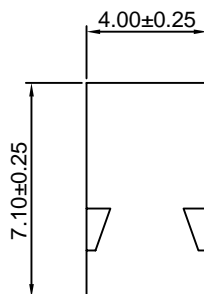
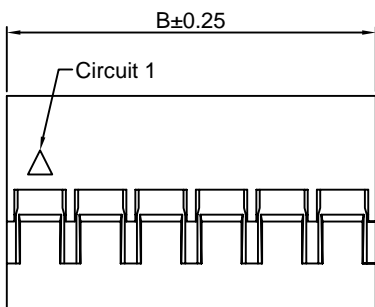
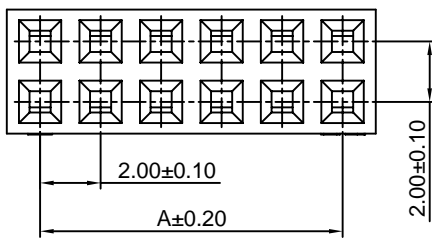
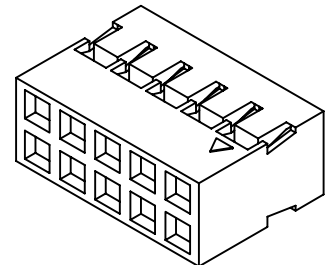

Ordering Information & Dimensions:

PART NO.	Dimensions		PART NO.	Dimensions	
	A	B		A	B
A2005H-2x2P	2.00	4.20	A2005H-2x22P	42.00	44.20
A2005H-2x3P	4.00	6.20	A2005H-2x23P	44.00	46.20
A2005H-2x4P	6.00	8.20	A2005H-2x24P	46.00	48.20
A2005H-2x5P	8.00	10.20	A2005H-2x25P	48.00	50.20
A2005H-2x6P	10.00	12.20	A2005H-2x26P	50.00	52.20
A2005H-2x7P	12.00	14.20	A2005H-2x27P	52.00	54.20
A2005H-2x8P	14.00	16.20	A2005H-2x28P	54.00	56.20
A2005H-2x9P	16.00	18.20	A2005H-2x29P	56.00	58.20
A2005H-2x10P	18.00	20.20	A2005H-2x30P	58.00	60.20
A2005H-2x11P	20.00	22.20	A2005H-2x31P	60.00	62.20
A2005H-2x12P	22.00	24.20	A2005H-2x32P	62.00	64.20
A2005H-2x13P	24.00	26.20	A2005H-2x33P	64.00	66.20
A2005H-2x14P	26.00	28.20	A2005H-2x34P	66.00	68.20
A2005H-2x15P	28.00	30.20	A2005H-2x35P	68.00	70.20
A2005H-2x16P	30.00	32.20	A2005H-2x36P	70.00	72.20
A2005H-2x17P	32.00	34.20	A2005H-2x37P	72.00	74.20
A2005H-2x18P	34.00	36.20	A2005H-2x38P	74.00	76.20
A2005H-2x19P	36.00	38.20	A2005H-2x39P	76.00	78.20
A2005H-2x20P	38.00	40.20	A2005H-2x40P	78.00	80.20
A2005H-2x21P	40.00	42.20			

Unit: mm

A2005H-N-2-B

2.00mm Pitch Dual Row Housing

Reference Informations:

- *Material:PBT,UL94V-0
- *Suitable CJT A2005 series Terminal
- *Mates with CJT A2005 series Dual Row Wafer
- *Color:Black

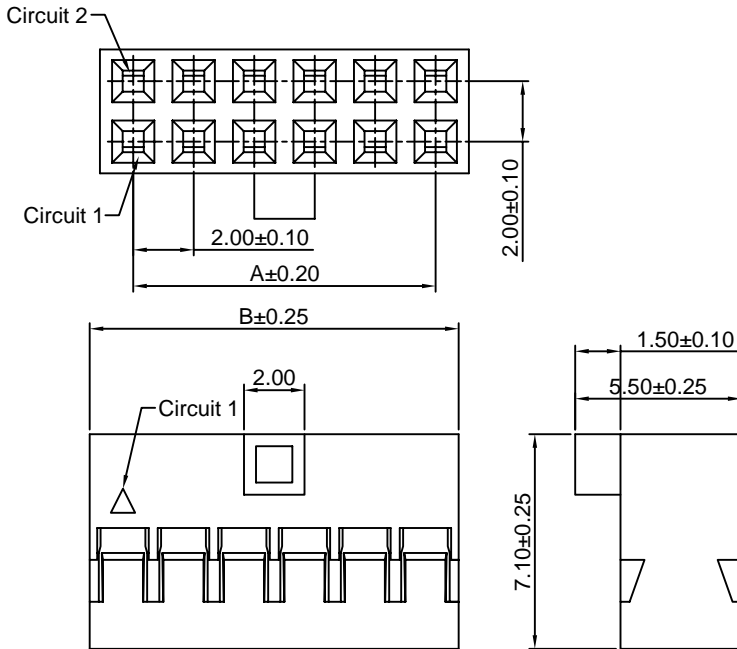
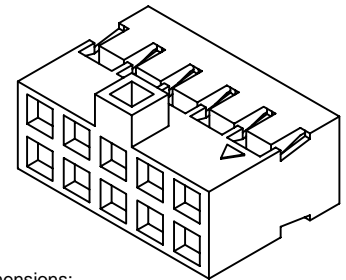

Ordering Information & Dimensions:

PART NO.	Dimensions		PART NO.	Dimensions	
	A	B		A	B
A2005H-N-2x2P-B	2.00	4.20	A2005H-N-2x22P-B	42.00	44.20
A2005H-N-2x3P-B	4.00	6.20	A2005H-N-2x23P-B	44.00	46.20
A2005H-N-2x4P-B	6.00	8.20	A2005H-N-2x24P-B	46.00	48.20
A2005H-N-2x5P-B	8.00	10.20	A2005H-N-2x25P-B	48.00	50.20
A2005H-N-2x6P-B	10.00	12.20	A2005H-N-2x26P-B	50.00	52.20
A2005H-N-2x7P-B	12.00	14.20	A2005H-N-2x27P-B	52.00	54.20
A2005H-N-2x8P-B	14.00	16.20	A2005H-N-2x28P-B	54.00	56.20
A2005H-N-2x9P-B	16.00	18.20	A2005H-N-2x29P-B	56.00	58.20
A2005H-N-2x10P-B	18.00	20.20	A2005H-N-2x30P-B	58.00	60.20
A2005H-N-2x11P-B	20.00	22.20	A2005H-N-2x31P-B	60.00	62.20
A2005H-N-2x12P-B	22.00	24.20	A2005H-N-2x32P-B	62.00	64.20
A2005H-N-2x13P-B	24.00	26.20	A2005H-N-2x33P-B	64.00	66.20
A2005H-N-2x14P-B	26.00	28.20	A2005H-N-2x34P-B	66.00	68.20
A2005H-N-2x15P-B	28.00	30.20	A2005H-N-2x35P-B	68.00	70.20
A2005H-N-2x16P-B	30.00	32.20	A2005H-N-2x36P-B	70.00	72.20
A2005H-N-2x17P-B	32.00	34.20	A2005H-N-2x37P-B	72.00	74.20
A2005H-N-2x18P-B	34.00	36.20	A2005H-N-2x38P-B	74.00	76.20
A2005H-N-2x19P-B	36.00	38.20	A2005H-N-2x39P-B	76.00	78.20
A2005H-N-2x20P-B	38.00	40.20	A2005H-N-2x40P-B	78.00	80.20
A2005H-N-2x21P-B	40.00	42.20			

Unit: mm

A2005HA-2

2.00mm Pitch Dual Row Housing

Reference Informations:

- *Material:Nylon 66,UL94V-0
- *Suitable CJT A2005-B series Terminal
- *Mates with CJT A2005 series Dual Row Wafer
- *Color:Black

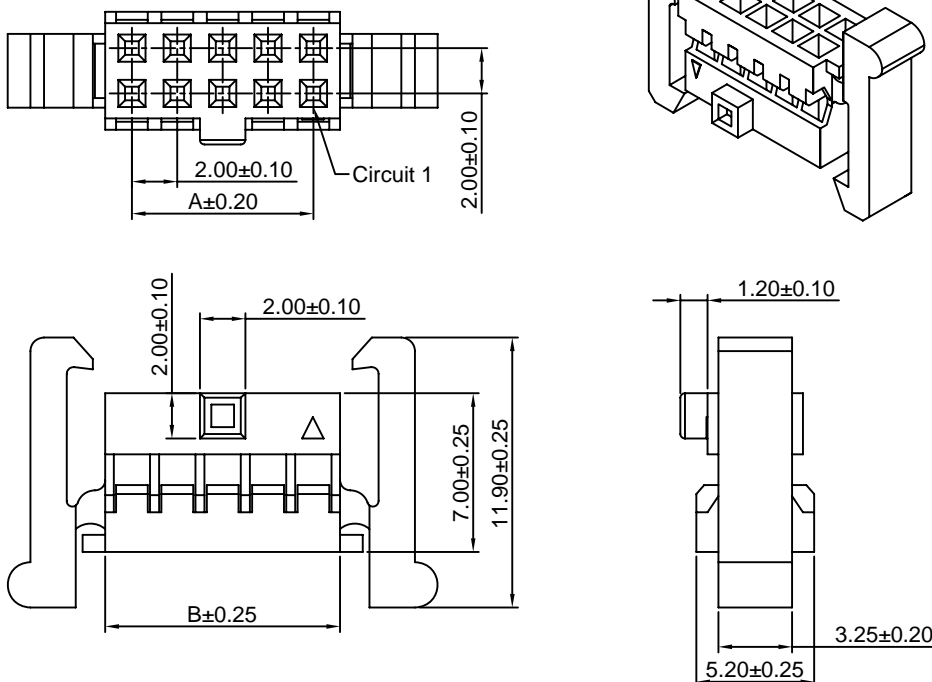
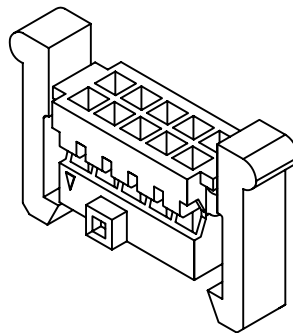

Ordering Information & Dimensions:

PART NO.	Dimensions	
	A	B
A2005HA-2x2P	2.00	4.35
A2005HA-2x3P	4.00	6.35
A2005HA-2x4P	6.00	8.35
A2005HA-2x5P	8.00	10.35
A2005HA-2x6P	10.00	12.35
A2005HA-2x7P	12.00	14.35
A2005HA-2x8P	14.00	16.35
A2005HA-2x9P	16.00	18.35
A2005HA-2x10P	18.00	20.35
A2005HA-2x11P	20.00	22.35
A2005HA-2x12P	22.00	24.35
A2005HA-2x13P	24.00	26.35
A2005HA-2x14P	26.00	28.35
A2005HA-2x15P	28.00	30.35
A2005HA-2x16P	30.00	32.35
A2005HA-2x17P	32.00	34.35
A2005HA-2x18P	34.00	36.35
A2005HA-2x19P	36.00	38.35
A2005HA-2x20P	38.00	40.35
A2005HA-2x21P	40.00	42.35
A2005HA-2x22P	42.00	44.35
A2005HA-2x23P	44.00	46.35
A2005HA-2x24P	46.00	48.35
A2005HA-2x25P	48.00	50.35

Unit: mm

A2005HB-N-2-B

2.00mm Pitch Dual Row Housing

Reference Informations:

- *Material:Nylon 66,UL94V-0
- *Suitable CJT A2005-B series Terminal
- *Mates with CJT A2005 series Dual Row Wafer
- *Color:Black

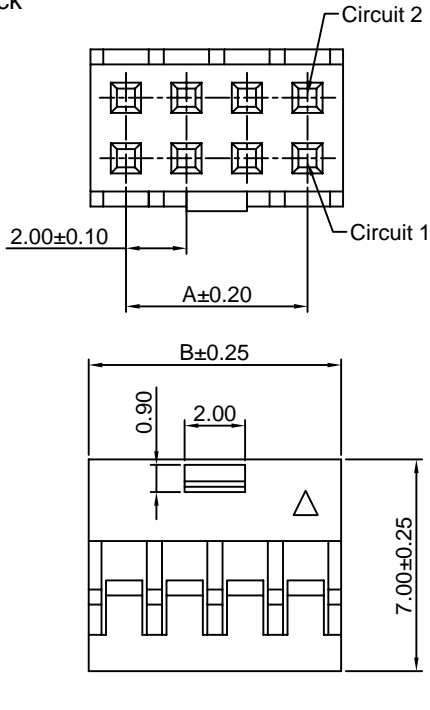
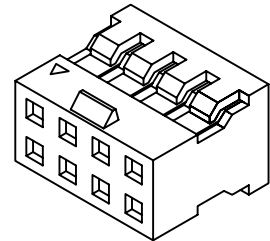

Ordering Information & Dimensions:

PART NO.	Dimensions	
	A	B
A2005HB-N-2x2P-B	2.00	4.35
A2005HB-N-2x3P-B	4.00	6.35
A2005HB-N-2x4P-B	6.00	8.35
A2005HB-N-2x5P-B	8.00	10.35
A2005HB-N-2x6P-B	10.00	12.35

Unit: mm

A2005HB-N-2-C

2.00mm Pitch Dual Row Housing

Reference Informations:

- *Material:Nylon 66,UL94V-0
- *Suitable CJT A2005-B series Terminal
- *Mates with CJT A2005 series Dual Row Wafer
- *Color:Black

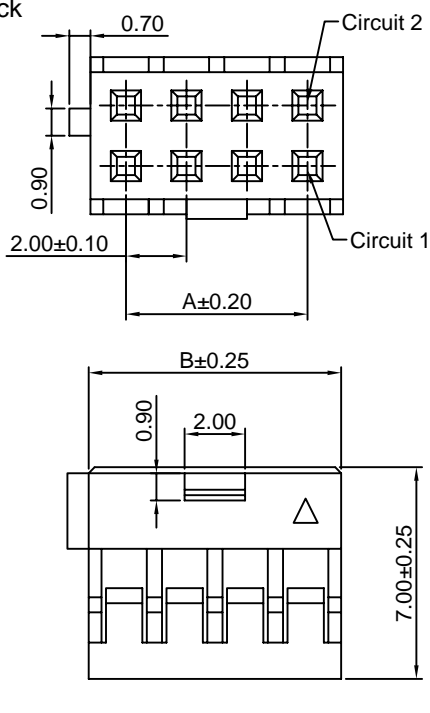
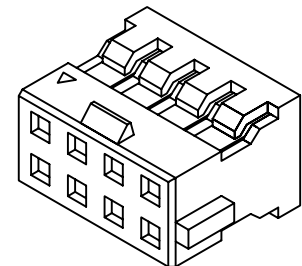

Ordering Information & Dimensions:

PART NO.	Dimensions	
	A	B
A2005HB-N-2x2P-C	2.00	4.35
A2005HB-N-2x3P-C	4.00	6.35
A2005HB-N-2x4P-C	6.00	8.35
A2005HB-N-2x5P-C	8.00	10.35
A2005HB-N-2x6P-C	10.00	12.35

Unit: mm

A2005HB-N-2-D

2.00mm Pitch Dual Row Housing

Reference Informations:

- *Material:Nylon 66,UL94V-0
- *Suitable CJT A2005-B series Terminal
- *Mates with CJT A2005 series Dual Row Wafer
- *Color:Black

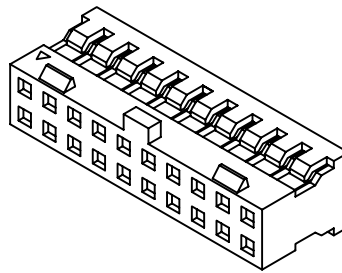

Ordering Information & Dimensions:

PART NO.	Dimensions		
	A	B	C
A2005HB-N-2x2P-D	2.00	4.35	---
A2005HB-N-2x3P-D	4.00	6.35	---
A2005HB-N-2x4P-D	6.00	8.35	---
A2005HB-N-2x5P-D	8.00	10.35	---
A2005HB-N-2x6P-D	10.00	12.35	---
A2005HB-N-2x7P-D	12.00	14.35	8.00
A2005HB-N-2x8P-D	14.00	16.35	10.00
A2005HB-N-2x9P-D	16.00	18.35	12.00
A2005HB-N-2x10P-D	18.00	20.35	14.00
A2005HB-N-2x11P-D	20.00	22.35	16.00
A2005HB-N-2x12P-D	22.00	24.35	18.00
A2005HB-N-2x13P-D	24.00	26.35	20.00
A2005HB-N-2x14P-D	26.00	28.35	22.00
A2005HB-N-2x15P-D	28.00	30.35	24.00
A2005HB-N-2x16P-D	30.00	32.35	26.00
A2005HB-N-2x17P-D	32.00	34.35	28.00
A2005HB-N-2x18P-D	34.00	36.35	30.00
A2005HB-N-2x19P-D	36.00	38.35	32.00
A2005HB-N-2x20P-D	38.00	40.35	34.00
A2005HB-N-2x21P-D	40.00	42.35	36.00
A2005HB-N-2x22P-D	42.00	44.35	38.00
A2005HB-N-2x23P-D	44.00	46.35	40.00
A2005HB-N-2x24P-D	46.00	48.35	42.00
A2005HB-N-2x25P-D	48.00	50.35	44.00

Unit: mm

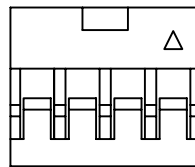
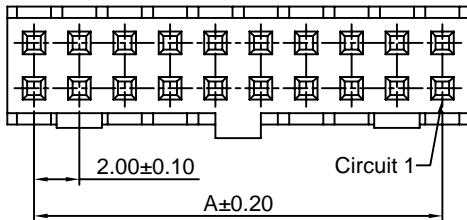

2x2P~2x6P

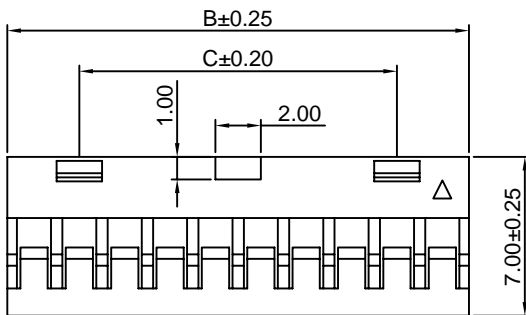

2x7P~2x25P

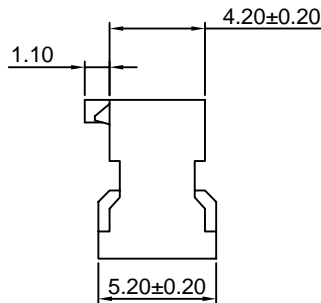

A2005HB-N-2-J

2.00mm Pitch Dual Row Housing

Reference Informations:

- *Material:Nylon 66,UL94V-0
- *Suitable CJT A2005-B series Terminal
- *Mates with CJT A2005 series Dual Row Wafer
- *Color:Black

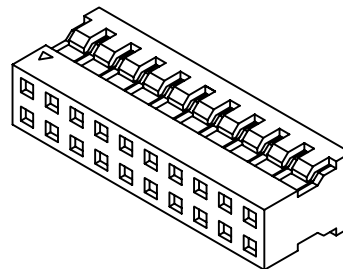

Ordering Information & Dimensions:

PART NO.	Dimensions	
	A	B
A2005HB-N-2x2P-J	2.00	4.35
A2005HB-N-2x3P-J	4.00	6.35
A2005HB-N-2x4P-J	6.00	8.35
A2005HB-N-2x5P-J	8.00	10.35
A2005HB-N-2x6P-J	10.00	12.35
A2005HB-N-2x7P-J	12.00	14.35
A2005HB-N-2x8P-J	14.00	16.35
A2005HB-N-2x9P-J	16.00	18.35
A2005HB-N-2x10P-J	18.00	20.35
A2005HB-N-2x11P-J	20.00	22.35
A2005HB-N-2x12P-J	22.00	24.35
A2005HB-N-2x13P-J	24.00	26.35
A2005HB-N-2x14P-J	26.00	28.35
A2005HB-N-2x15P-J	28.00	30.35
A2005HB-N-2x16P-J	30.00	32.35
A2005HB-N-2x17P-J	32.00	34.35
A2005HB-N-2x18P-J	34.00	36.35
A2005HB-N-2x19P-J	36.00	38.35
A2005HB-N-2x20P-J	38.00	40.35
A2005HB-N-2x21P-J	40.00	42.35
A2005HB-N-2x22P-J	42.00	44.35
A2005HB-N-2x23P-J	44.00	46.35
A2005HB-N-2x24P-J	46.00	48.35
A2005HB-N-2x25P-J	48.00	50.35

Unit: mm

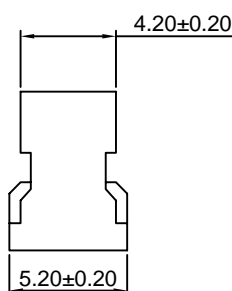
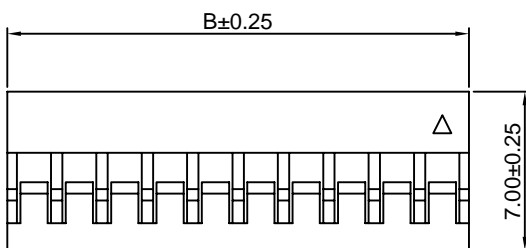
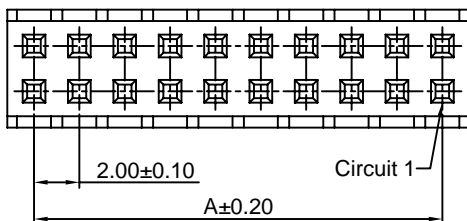

A2005HB-N-2-F

2.00mm Pitch Dual Row Housing

Reference Informations:

- *Material:Nylon 66,UL94V-0
- *Suitable CJT A2005-B series Terminal
- *Mates with CJT A2005 series Dual Row Wafer
- *Color:Black

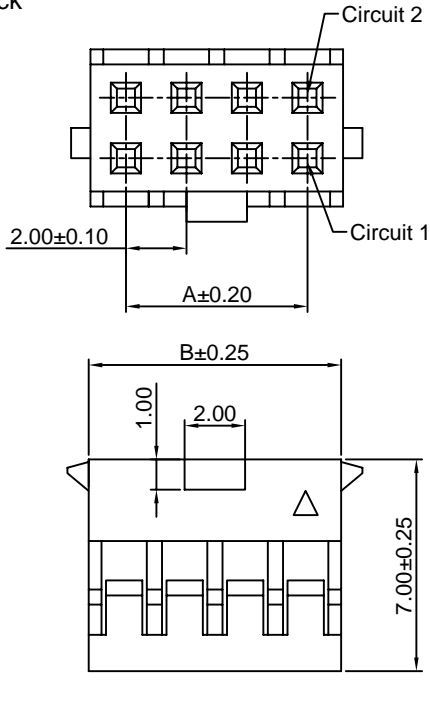
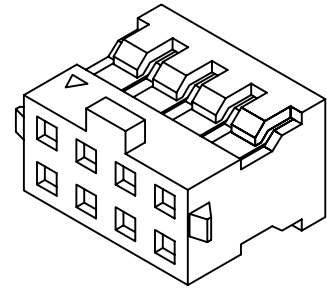

Ordering Information & Dimensions:

PART NO.	Dimensions	
	A	B
A2005HB-N-2x2P-F	2.00	4.35
A2005HB-N-2x3P-F	4.00	6.35
A2005HB-N-2x4P-F	6.00	8.35
A2005HB-N-2x5P-F	8.00	10.35
A2005HB-N-2x6P-F	10.00	12.35

Unit: mm

A2005HB-N-2-FI

2.00mm Pitch Dual Row Housing

Reference Informations:

- *Material:Nylon 66,UL94V-0
- *Suitable CJT A2005 series Terminal
- *Mates with CJT A2005WV-N-FI series Dual Row Wafer
- *Color:Black

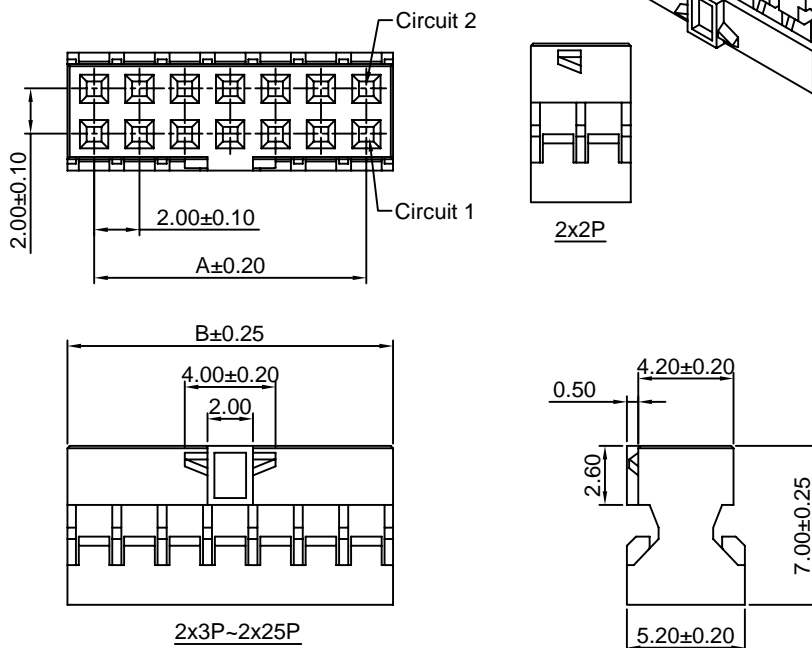
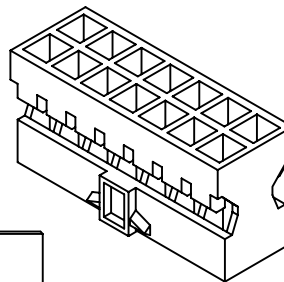

Ordering Information & Dimensions:

PART NO.	Dimensions	
	A	B
A2005HB-N-2x2P-FI	2.00	4.35
A2005HB-N-2x3P-FI	4.00	6.35
A2005HB-N-2x4P-FI	6.00	8.35
A2005HB-N-2x5P-FI	8.00	10.35
A2005HB-N-2x6P-FI	10.00	12.35
A2005HB-N-2x7P-FI	12.00	14.35
A2005HB-N-2x8P-FI	14.00	16.35
A2005HB-N-2x9P-FI	16.00	18.35
A2005HB-N-2x10P-FI	18.00	20.35
A2005HB-N-2x11P-FI	20.00	22.35
A2005HB-N-2x12P-FI	22.00	24.35
A2005HB-N-2x13P-FI	24.00	26.35
A2005HB-N-2x14P-FI	26.00	28.35
A2005HB-N-2x15P-FI	28.00	30.35
A2005HB-N-2x16P-FI	30.00	32.35
A2005HB-N-2x17P-FI	32.00	34.35
A2005HB-N-2x18P-FI	34.00	36.35
A2005HB-N-2x19P-FI	36.00	38.35
A2005HB-N-2x20P-FI	38.00	40.35
A2005HB-N-2x21P-FI	40.00	42.35
A2005HB-N-2x22P-FI	42.00	44.35
A2005HB-N-2x23P-FI	44.00	46.35
A2005HB-N-2x24P-FI	46.00	48.35
A2005HB-N-2x25P-FI	48.00	50.35

Unit: mm

A2005WV-N-2

2.00mm Pitch 180° Dual Row Box Header

Reference Informations:

- *Material:Pin:Brass/Gold over Nickel
Insulator:PBT,UL94V-0
- *Mates with CJT A2005 series Dual Row Housing
- *Color:Black

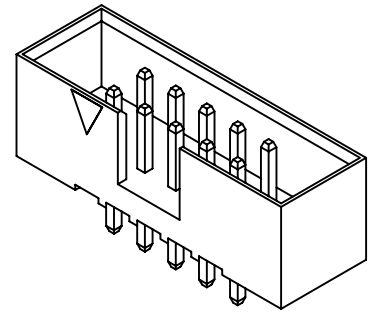
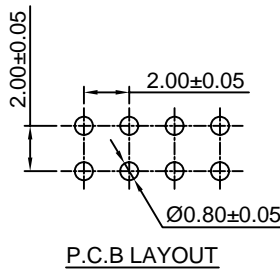
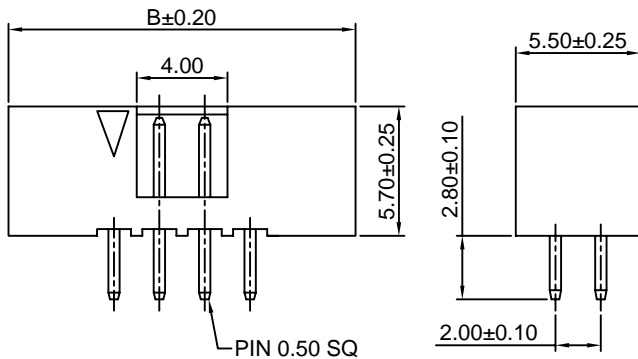
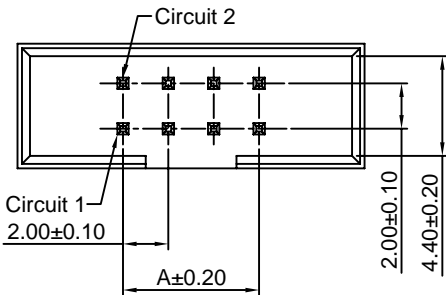

Ordering Information & Dimensions:

PART NO.	Dimensions		PART NO.	Dimensions	
	A	B		A	B
A2005WV-N-2x4P	6.00	15.30	A2005WV-N-2x20P	38.00	47.30
A2005WV-N-2x5P	8.00	17.30	A2005WV-N-2x21P	40.00	49.30
A2005WV-N-2x6P	10.00	19.30	A2005WV-N-2x22P	42.00	51.30
A2005WV-N-2x7P	12.00	21.30	A2005WV-N-2x23P	44.00	53.30
A2005WV-N-2x8P	14.00	23.30	A2005WV-N-2x24P	46.00	55.30
A2005WV-N-2x9P	16.00	25.30	A2005WV-N-2x25P	48.00	57.30
A2005WV-N-2x10P	18.00	27.30	A2005WV-N-2x26P	50.00	57.30
A2005WV-N-2x11P	20.00	29.30	A2005WV-N-2x27P	52.00	59.30
A2005WV-N-2x12P	22.00	31.30	A2005WV-N-2x28P	54.00	61.30
A2005WV-N-2x13P	24.00	33.30	A2005WV-N-2x29P	56.00	63.30
A2005WV-N-2x14P	26.00	35.30	A2005WV-N-2x30P	58.00	65.30
A2005WV-N-2x15P	28.00	37.30	A2005WV-N-2x31P	60.00	67.30
A2005WV-N-2x16P	30.00	39.30	A2005WV-N-2x32P	62.00	69.30
A2005WV-N-2x17P	32.00	41.30	A2005WV-N-2x33P	64.00	71.30
A2005WV-N-2x18P	34.00	43.30	A2005WV-N-2x34P	66.00	73.30
A2005WV-N-2x19P	36.00	45.30			

Unit: mm

A2005WR-N-2

2.00mm Pitch 90° Dual Row Box Header

Reference Informations:

- *Material:Pin:Brass/Gold over Nickel
Insulator:PBT,UL94V-0
- *Mates with CJT A2005 series Dual Row Housing
- *Color:Black

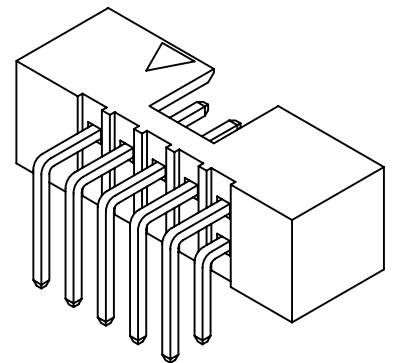
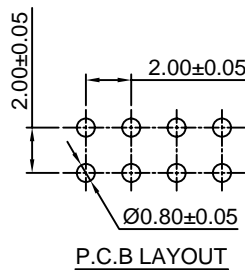
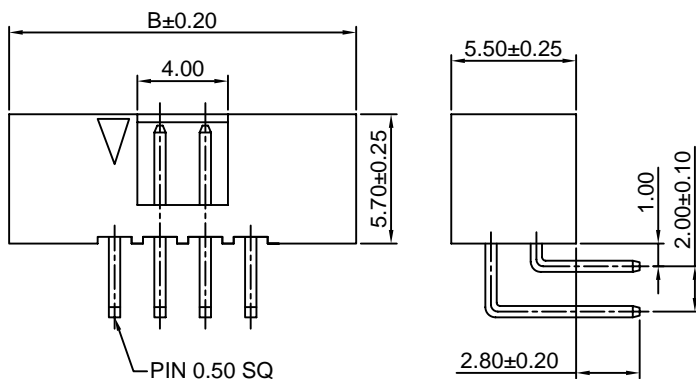
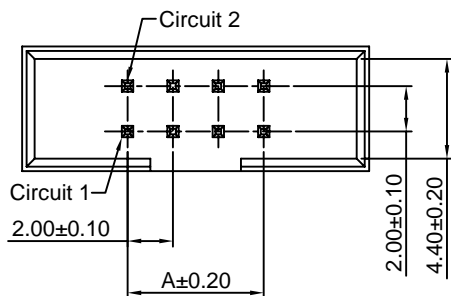

Ordering Information & Dimensions:

PART NO.	Dimensions		PART NO.	Dimensions	
	A	B		A	B
A2005WR-N-2x4P	6.00	15.30	A2005WR-N-2x20P	38.00	47.30
A2005WR-N-2x5P	8.00	17.30	A2005WR-N-2x21P	40.00	49.30
A2005WR-N-2x6P	10.00	19.30	A2005WR-N-2x22P	42.00	51.30
A2005WR-N-2x7P	12.00	21.30	A2005WR-N-2x23P	44.00	53.30
A2005WR-N-2x8P	14.00	23.30	A2005WR-N-2x24P	46.00	55.30
A2005WR-N-2x9P	16.00	25.30	A2005WR-N-2x25P	48.00	57.30
A2005WR-N-2x10P	18.00	27.30	A2005WR-N-2x26P	50.00	57.30
A2005WR-N-2x11P	20.00	29.30	A2005WR-N-2x27P	52.00	59.30
A2005WR-N-2x12P	22.00	31.30	A2005WR-N-2x28P	54.00	61.30
A2005WR-N-2x13P	24.00	33.30	A2005WR-N-2x29P	56.00	63.30
A2005WR-N-2x14P	26.00	35.30	A2005WR-N-2x30P	58.00	65.30
A2005WR-N-2x15P	28.00	37.30	A2005WR-N-2x31P	60.00	67.30
A2005WR-N-2x16P	30.00	39.30	A2005WR-N-2x32P	62.00	69.30
A2005WR-N-2x17P	32.00	41.30	A2005WR-N-2x33P	64.00	71.30
A2005WR-N-2x18P	34.00	43.30	A2005WR-N-2x34P	66.00	73.30
A2005WR-N-2x19P	36.00	45.30			

Unit: mm

A2005WV-N-2-A

2.00mm Pitch 180° Dual Row Box Header - A TYPE

Reference Informations:

- *Material: Pin: Brass/Gold over Nickel
Insulator: Nylon 6T, UL94V-0
- *Mates with CJT A2005 series Dual Row Housing
- *Color: Black

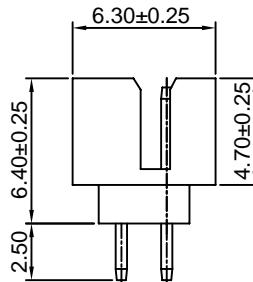
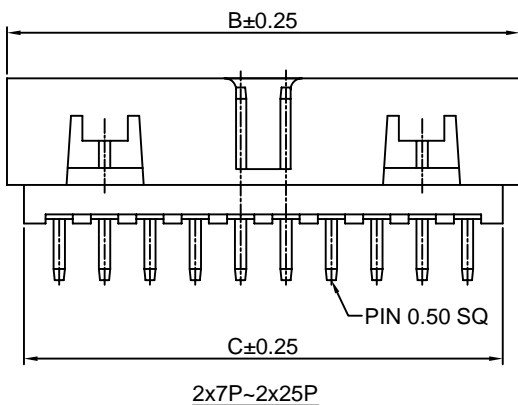
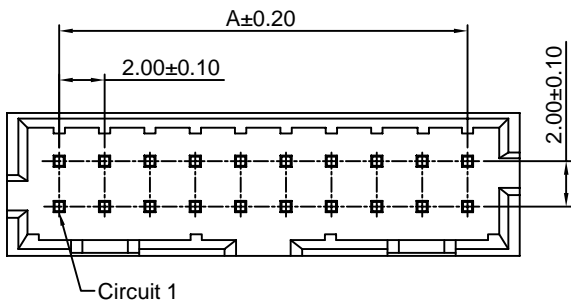
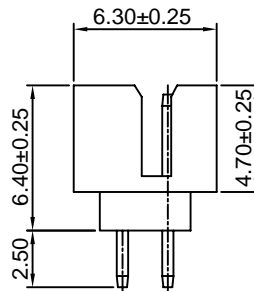
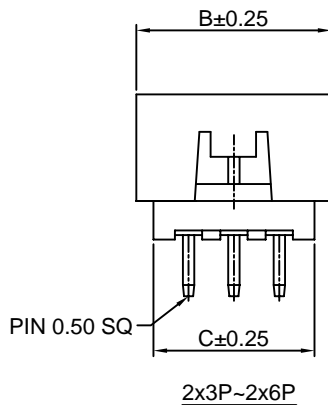
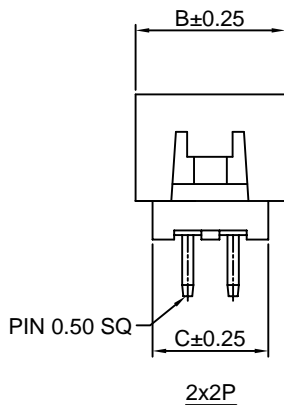
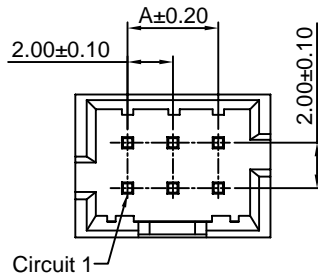
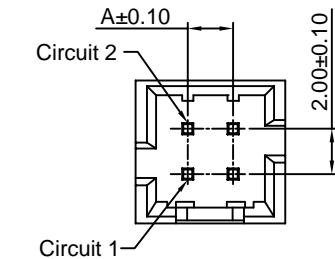
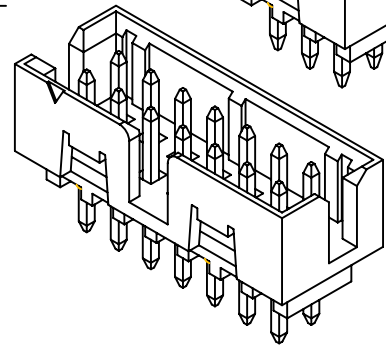
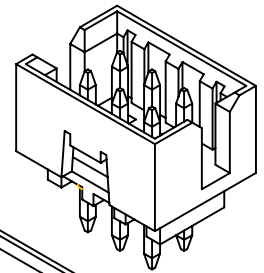
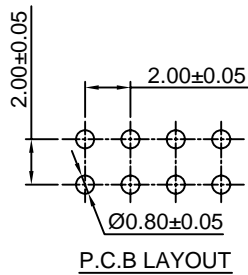

Ordering Information & Dimensions:

PART NO.	Dimensions		
	A	B	C
A2005WV-N-2x2P-A	2.00	6.65	5.00
A2005WV-N-2x3P-A	4.00	8.65	7.00
A2005WV-N-2x4P-A	6.00	10.65	9.00
A2005WV-N-2x5P-A	8.00	12.65	11.00
A2005WV-N-2x6P-A	10.00	14.65	13.00
A2005WV-N-2x7P-A	12.00	16.65	15.00
A2005WV-N-2x8P-A	14.00	18.65	17.00
A2005WV-N-2x9P-A	16.00	20.65	19.00
A2005WV-N-2x10P-A	18.00	22.65	21.00
A2005WV-N-2x11P-A	20.00	24.65	23.00
A2005WV-N-2x12P-A	22.00	26.65	25.00
A2005WV-N-2x13P-A	24.00	28.65	27.00
A2005WV-N-2x14P-A	26.00	30.65	29.00
A2005WV-N-2x15P-A	28.00	32.65	31.00
A2005WV-N-2x16P-A	30.00	34.65	33.00
A2005WV-N-2x17P-A	32.00	36.65	35.00
A2005WV-N-2x18P-A	34.00	38.65	37.00
A2005WV-N-2x19P-A	36.00	40.65	39.00
A2005WV-N-2x20P-A	38.00	42.65	41.00
A2005WV-N-2x21P-A	30.00	44.65	43.00
A2005WV-N-2x22P-A	32.00	46.65	45.00
A2005WV-N-2x23P-A	34.00	48.65	47.00
A2005WV-N-2x24P-A	36.00	50.65	49.00
A2005WV-N-2x25P-A	38.00	52.65	51.00

Unit: mm

A2005WV-N-2-B

2.00mm Pitch 180° Dual Row Box Header - B TYPE

Reference Informations:

- *Material: Pin: Brass/Gold over Nickel
Insulator: Nylon 6T, UL94V-0
- *Mates with CJT A2005 series Dual Row Housing
- *Color: Black

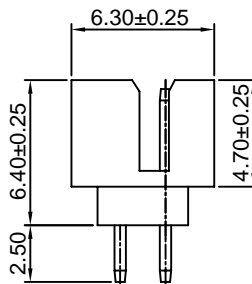
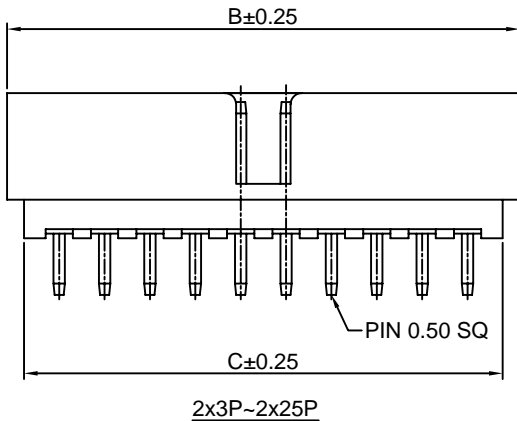
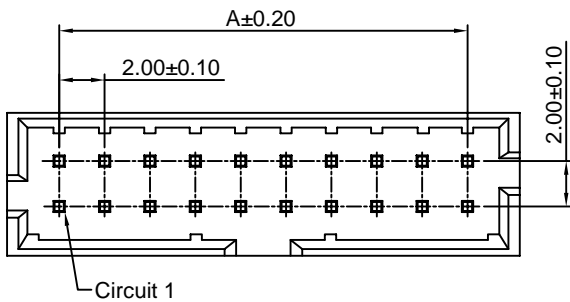
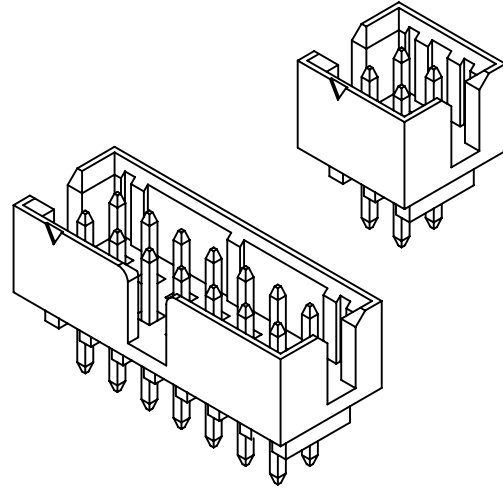
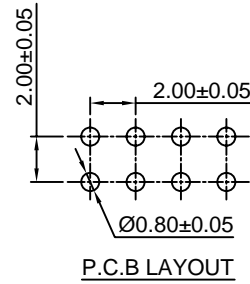
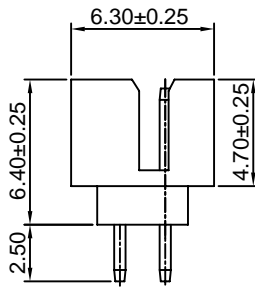
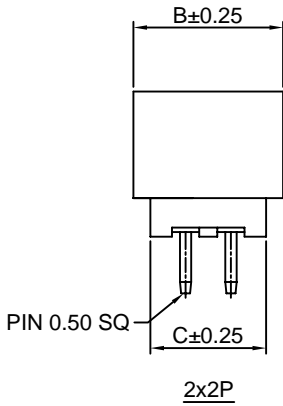
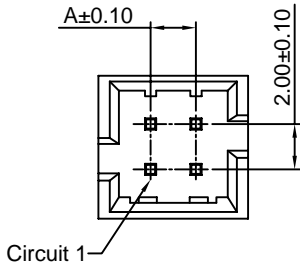

Ordering Information & Dimensions:

PART NO.	Dimensions		
	A	B	C
A2005WV-N-2x2P-B	2.00	6.65	5.00
A2005WV-N-2x3P-B	4.00	8.65	7.00
A2005WV-N-2x4P-B	6.00	10.65	9.00
A2005WV-N-2x5P-B	8.00	12.65	11.00
A2005WV-N-2x6P-B	10.00	14.65	13.00
A2005WV-N-2x7P-B	12.00	16.65	15.00
A2005WV-N-2x8P-B	14.00	18.65	17.00
A2005WV-N-2x9P-B	16.00	20.65	19.00
A2005WV-N-2x10P-B	18.00	22.65	21.00
A2005WV-N-2x11P-B	20.00	24.65	23.00
A2005WV-N-2x12P-B	22.00	26.65	25.00
A2005WV-N-2x13P-B	24.00	28.65	27.00
A2005WV-N-2x14P-B	26.00	30.65	29.00
A2005WV-N-2x15P-B	28.00	32.65	31.00
A2005WV-N-2x16P-B	30.00	34.65	33.00
A2005WV-N-2x17P-B	32.00	36.65	35.00
A2005WV-N-2x18P-B	34.00	38.65	37.00
A2005WV-N-2x19P-B	36.00	40.65	39.00
A2005WV-N-2x20P-B	38.00	42.65	41.00
A2005WV-N-2x21P-B	30.00	44.65	43.00
A2005WV-N-2x22P-B	32.00	46.65	45.00
A2005WV-N-2x23P-B	34.00	48.65	47.00
A2005WV-N-2x24P-B	36.00	50.65	49.00
A2005WV-N-2x25P-B	38.00	52.65	51.00

Unit: mm

A2005WV-N-S-2-A

2.00mm Pitch 180° Dual Row Box Header - SMT A TYPE

Reference Informations:

- *Material: Pin: Brass/Gold over Nickel
Insulator: Nylon 6T, UL94V-0
- *Mates with CJT A2005 series Dual Row Housing
- *Color: Black

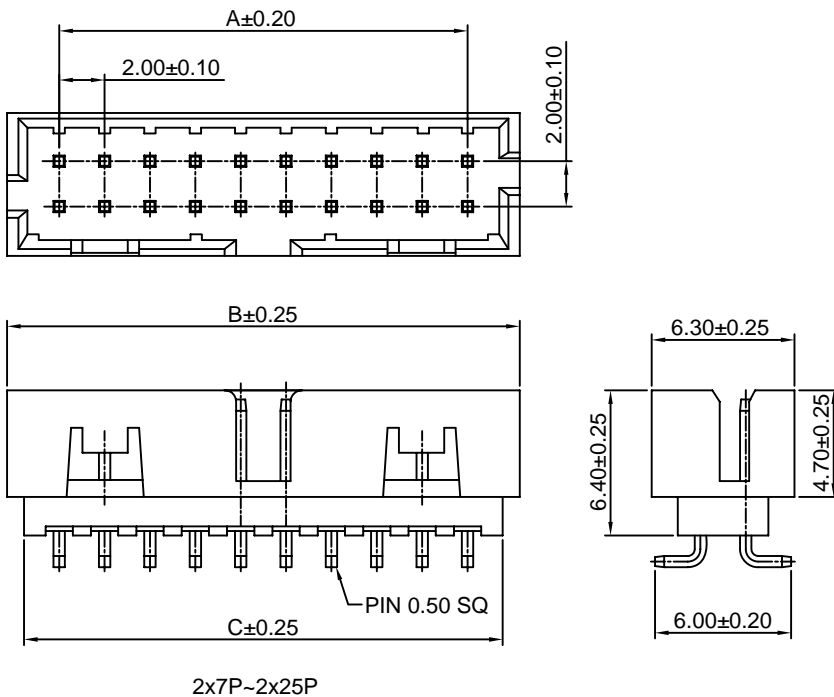
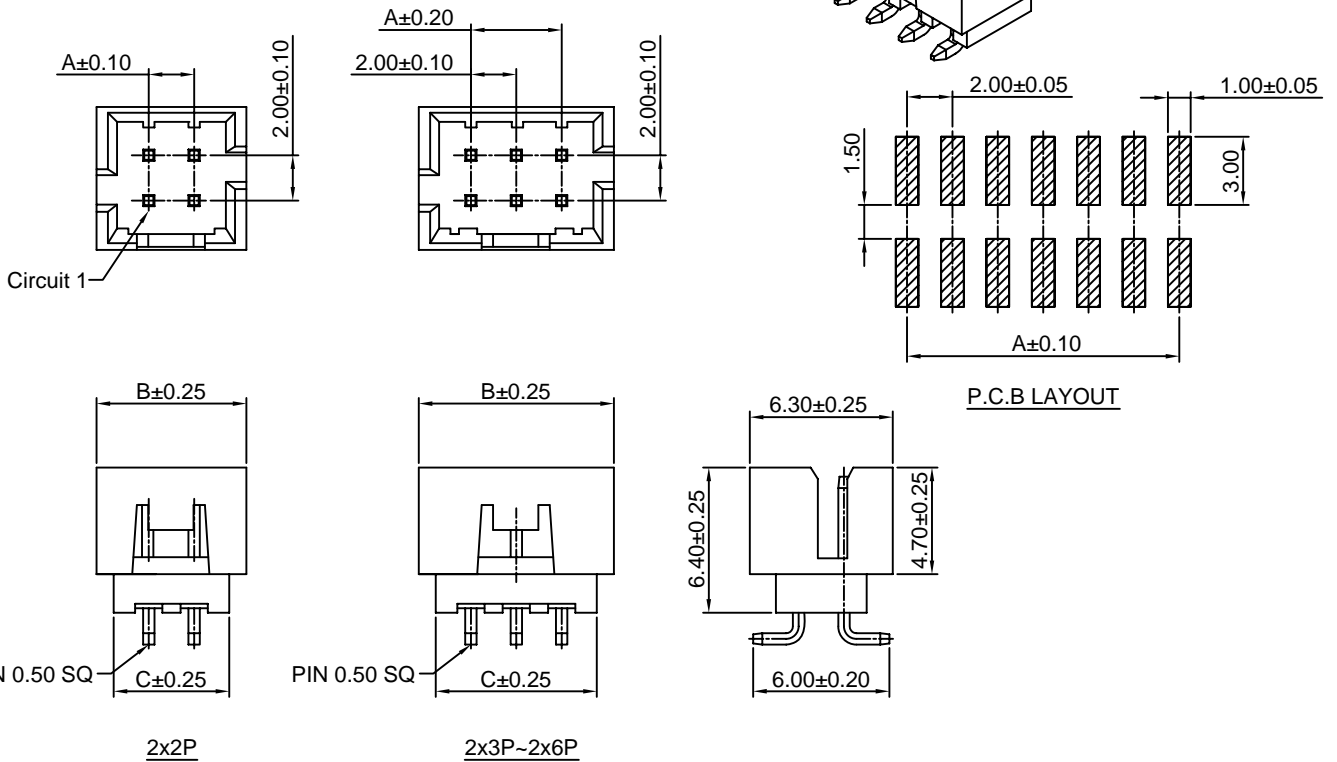
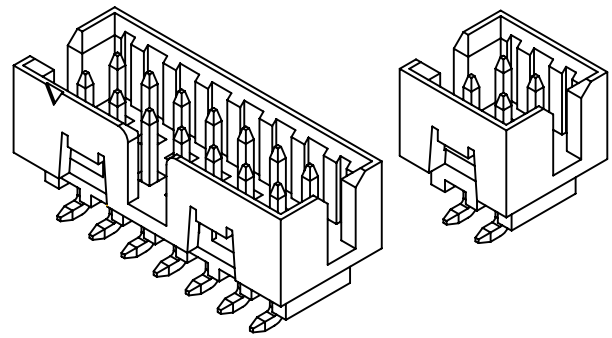

Ordering Information & Dimensions:

PART NO.	Dimensions		
	A	B	C
A2005WV-N-S-2x2P-A	2.00	6.65	5.00
A2005WV-N-S-2x3P-A	4.00	8.65	7.00
A2005WV-N-S-2x4P-A	6.00	10.65	9.00
A2005WV-N-S-2x5P-A	8.00	12.65	11.00
A2005WV-N-S-2x6P-A	10.00	14.65	13.00
A2005WV-N-S-2x7P-A	12.00	16.65	15.00
A2005WV-N-S-2x8P-A	14.00	18.65	17.00
A2005WV-N-S-2x9P-A	16.00	20.65	19.00
A2005WV-N-S-2x10P-A	18.00	22.65	21.00
A2005WV-N-S-2x11P-A	20.00	24.65	23.00
A2005WV-N-S-2x12P-A	22.00	26.65	25.00
A2005WV-N-S-2x13P-A	24.00	28.65	27.00
A2005WV-N-S-2x14P-A	26.00	30.65	29.00
A2005WV-N-S-2x15P-A	28.00	32.65	31.00
A2005WV-N-S-2x16P-A	30.00	34.65	33.00
A2005WV-N-S-2x17P-A	32.00	36.65	35.00
A2005WV-N-S-2x18P-A	34.00	38.65	37.00
A2005WV-N-S-2x19P-A	36.00	40.65	39.00
A2005WV-N-S-2x20P-A	38.00	42.65	41.00
A2005WV-N-S-2x21P-A	30.00	44.65	43.00
A2005WV-N-S-2x22P-A	32.00	46.65	45.00
A2005WV-N-S-2x23P-A	34.00	48.65	47.00
A2005WV-N-S-2x24P-A	36.00	50.65	49.00
A2005WV-N-S-2x25P-A	38.00	52.65	51.00

Unit: mm

A2005WV-N-S-2-B

2.00mm Pitch 180° Dual Row Box Header - SMT B TYPE

Reference Informations:

- *Material: Pin: Brass/Gold over Nickel
Insulator: Nylon 6T, UL94V-0
- *Mates with CJT A2005 series Dual Row Housing
- *Color: Black

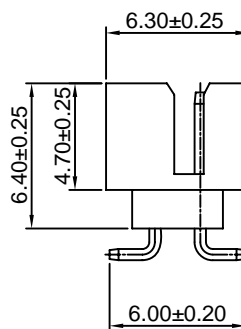
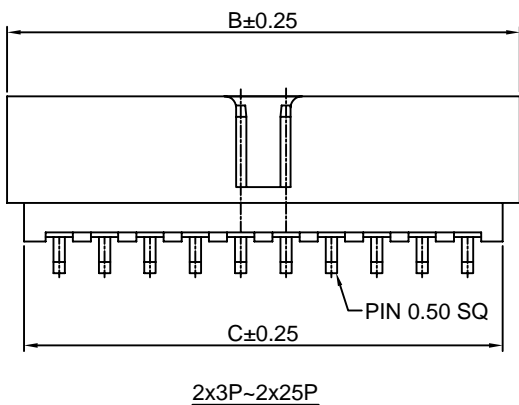
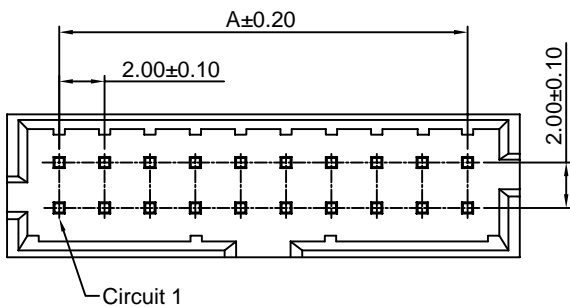
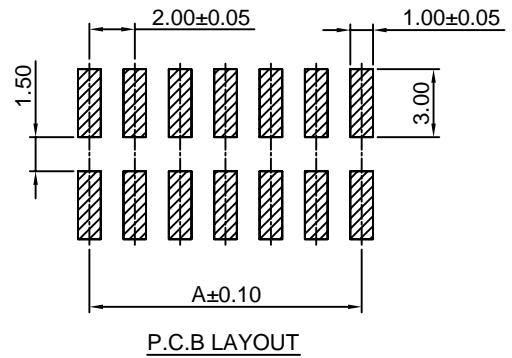
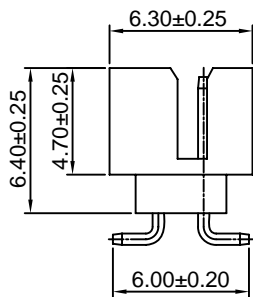
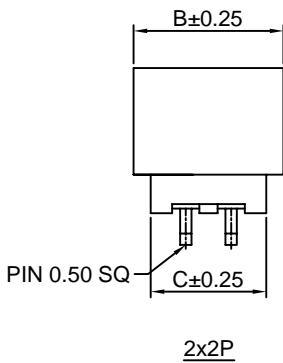
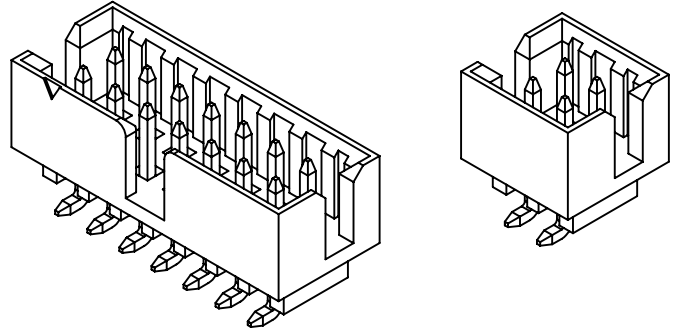
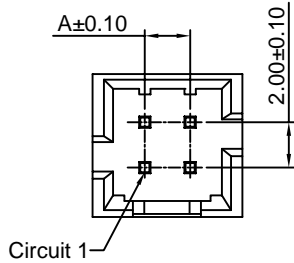

Ordering Information & Dimensions:

PART NO.	Dimensions		
	A	B	C
A2005WV-N-S-2x2P-B	2.00	6.65	5.00
A2005WV-N-S-2x3P-B	4.00	8.65	7.00
A2005WV-N-S-2x4P-B	6.00	10.65	9.00
A2005WV-N-S-2x5P-B	8.00	12.65	11.00
A2005WV-N-S-2x6P-B	10.00	14.65	13.00
A2005WV-N-S-2x7P-B	12.00	16.65	15.00
A2005WV-N-S-2x8P-B	14.00	18.65	17.00
A2005WV-N-S-2x9P-B	16.00	20.65	19.00
A2005WV-N-S-2x10P-B	18.00	22.65	21.00
A2005WV-N-S-2x11P-B	20.00	24.65	23.00
A2005WV-N-S-2x12P-B	22.00	26.65	25.00
A2005WV-N-S-2x13P-B	24.00	28.65	27.00
A2005WV-N-S-2x14P-B	26.00	30.65	29.00
A2005WV-N-S-2x15P-B	28.00	32.65	31.00
A2005WV-N-S-2x16P-B	30.00	34.65	33.00
A2005WV-N-S-2x17P-B	32.00	36.65	35.00
A2005WV-N-S-2x18P-B	34.00	38.65	37.00
A2005WV-N-S-2x19P-B	36.00	40.65	39.00
A2005WV-N-S-2x20P-B	38.00	42.65	41.00
A2005WV-N-S-2x21P-B	30.00	44.65	43.00
A2005WV-N-S-2x22P-B	32.00	46.65	45.00
A2005WV-N-S-2x23P-B	34.00	48.65	47.00
A2005WV-N-S-2x24P-B	36.00	50.65	49.00
A2005WV-N-S-2x25P-B	38.00	52.65	51.00

Unit: mm

A2005WV-N-S-F-2-A

2.00mm Pitch 180° Dual Row Box Header - SMT A TYPE

Reference Informations:

- *Material: Pin: Brass/Gold over Nickel
Insulator: Nylon 6T, UL94V-0
- *Mates with CJT A2005 series Dual Row Housing
- *Color: Black

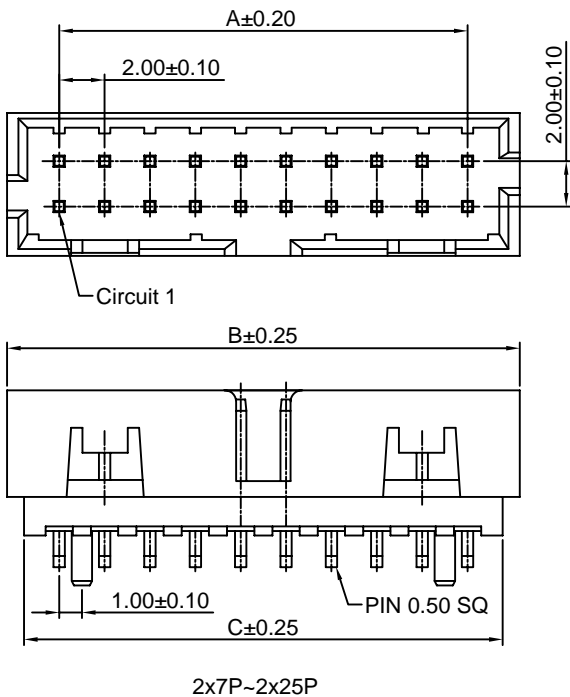
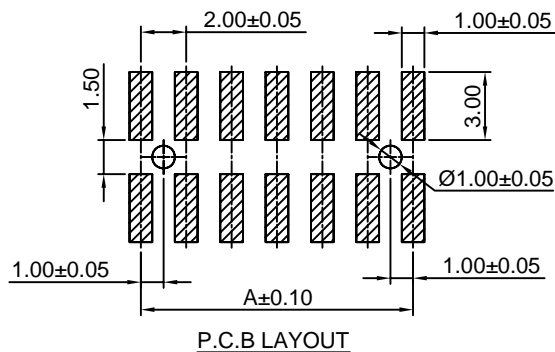
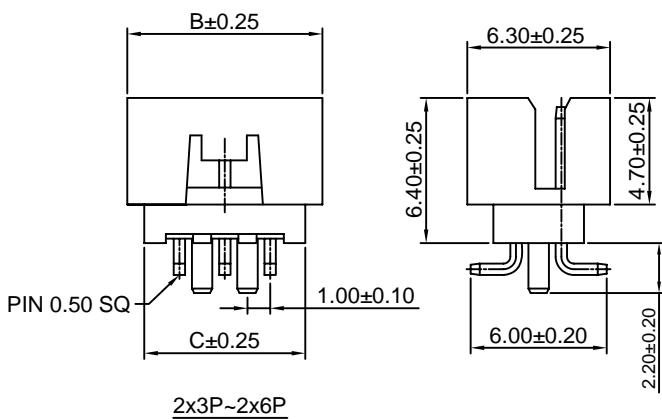
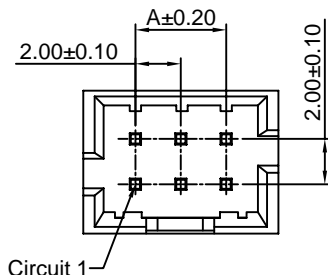
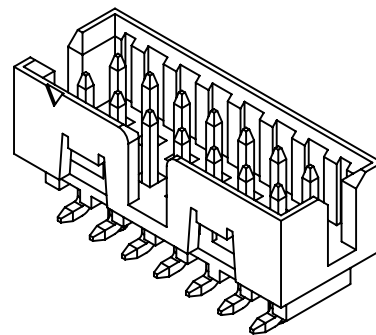

Ordering Information & Dimensions:

PART NO.	Dimensions		
	A	B	C
A2005WV-N-S-F-2x3P-A	4.00	8.65	7.00
A2005WV-N-S-F-2x4P-A	6.00	10.65	9.00
A2005WV-N-S-F-2x5P-A	8.00	12.65	11.00
A2005WV-N-S-F-2x6P-A	10.00	14.65	13.00
A2005WV-N-S-F-2x7P-A	12.00	16.65	15.00
A2005WV-N-S-F-2x8P-A	14.00	18.65	17.00
A2005WV-N-S-F-2x9P-A	16.00	20.65	19.00
A2005WV-N-S-F-2x10P-A	18.00	22.65	21.00
A2005WV-N-S-F-2x11P-A	20.00	24.65	23.00
A2005WV-N-S-F-2x12P-A	22.00	26.65	25.00
A2005WV-N-S-F-2x13P-A	24.00	28.65	27.00
A2005WV-N-S-F-2x14P-A	26.00	30.65	29.00
A2005WV-N-S-F-2x15P-A	28.00	32.65	31.00
A2005WV-N-S-F-2x16P-A	30.00	34.65	33.00
A2005WV-N-S-F-2x17P-A	32.00	36.65	35.00
A2005WV-N-S-F-2x18P-A	34.00	38.65	37.00
A2005WV-N-S-F-2x19P-A	36.00	40.65	39.00
A2005WV-N-S-F-2x20P-A	38.00	42.65	41.00
A2005WV-N-S-F-2x21P-A	30.00	44.65	43.00
A2005WV-N-S-F-2x22P-A	32.00	46.65	45.00
A2005WV-N-S-F-2x23P-A	34.00	48.65	47.00
A2005WV-N-S-F-2x24P-A	36.00	50.65	49.00
A2005WV-N-S-F-2x25P-A	38.00	52.65	51.00

Unit: mm

A2005WV-N-S-F-2-B

2.00mm Pitch 180° Dual Row Box Header - SMT B TYPE

Reference Informations:

- *Material:Pin:Brass/Gold over Nickel
Insulator:Nylon 6T,UL94V-0
- *Mates with CJT A2005 series Dual Row Housing
- *Color:Black

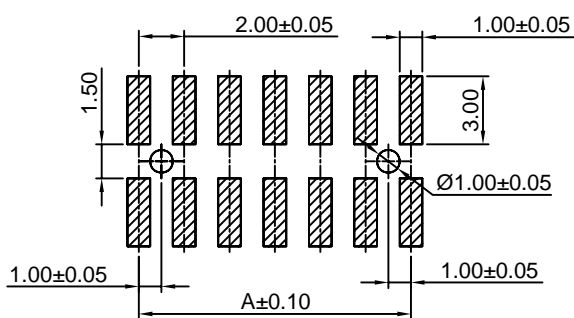
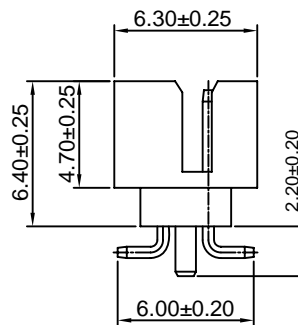
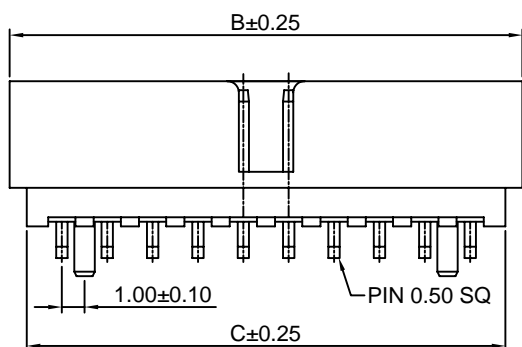
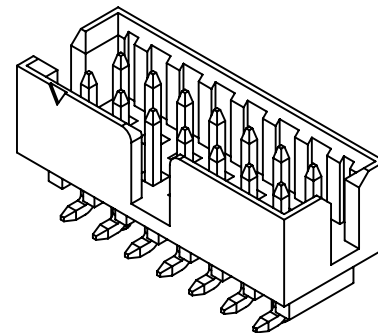
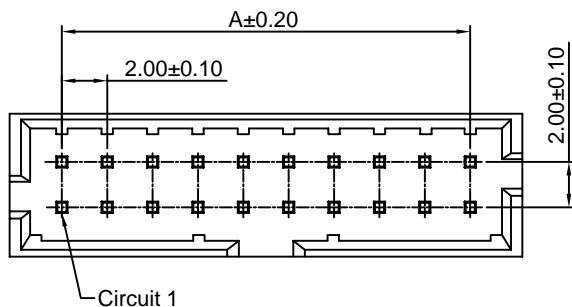

P.C.B LAYOUT

Ordering Information & Dimensions:

PART NO.	Dimensions		
	A	B	C
A2005WV-N-S-F-2x3P-B	4.00	8.65	7.00
A2005WV-N-S-F-2x4P-B	6.00	10.65	9.00
A2005WV-N-S-F-2x5P-B	8.00	12.65	11.00
A2005WV-N-S-F-2x6P-B	10.00	14.65	13.00
A2005WV-N-S-F-2x7P-B	12.00	16.65	15.00
A2005WV-N-S-F-2x8P-B	14.00	18.65	17.00
A2005WV-N-S-F-2x9P-B	16.00	20.65	19.00
A2005WV-N-S-F-2x10P-B	18.00	22.65	21.00
A2005WV-N-S-F-2x11P-B	20.00	24.65	23.00
A2005WV-N-S-F-2x12P-B	22.00	26.65	25.00
A2005WV-N-S-F-2x13P-B	24.00	28.65	27.00
A2005WV-N-S-F-2x14P-B	26.00	30.65	29.00
A2005WV-N-S-F-2x15P-B	28.00	32.65	31.00
A2005WV-N-S-F-2x16P-B	30.00	34.65	33.00
A2005WV-N-S-F-2x17P-B	32.00	36.65	35.00
A2005WV-N-S-F-2x18P-B	34.00	38.65	37.00
A2005WV-N-S-F-2x19P-B	36.00	40.65	39.00
A2005WV-N-S-F-2x20P-B	38.00	42.65	41.00
A2005WV-N-S-F-2x21P-B	30.00	44.65	43.00
A2005WV-N-S-F-2x22P-B	32.00	46.65	45.00
A2005WV-N-S-F-2x23P-B	34.00	48.65	47.00
A2005WV-N-S-F-2x24P-B	36.00	50.65	49.00
A2005WV-N-S-F-2x25P-B	38.00	52.65	51.00

Unit: mm

A2005WR-N-2-A

2.00mm Pitch 90° Dual Row Box Header - A TYPE

Reference Informations:

- *Material: Pin: Brass/Gold over Nickel
Insulator: Nylon 6T, UL94V-0
- *Mates with CJT A2005 series Dual Row Housing
- *Color: Black

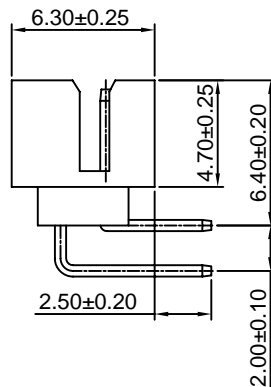
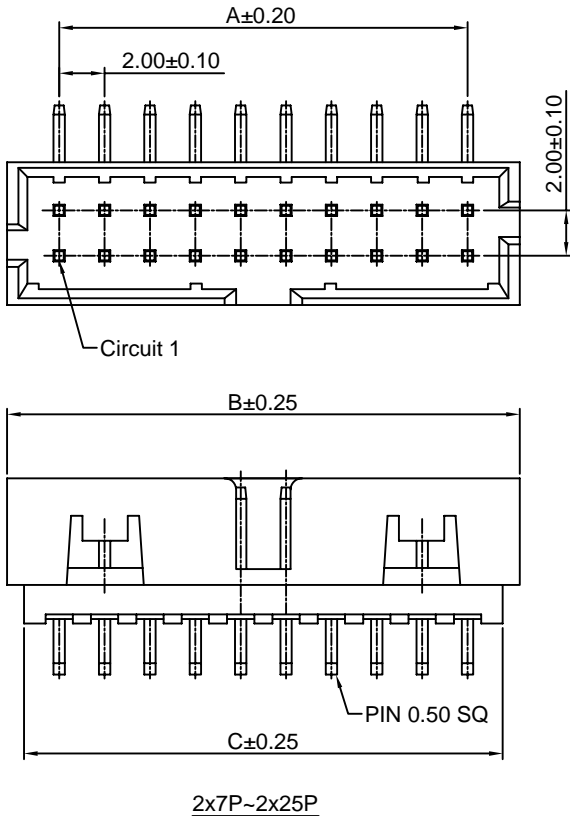
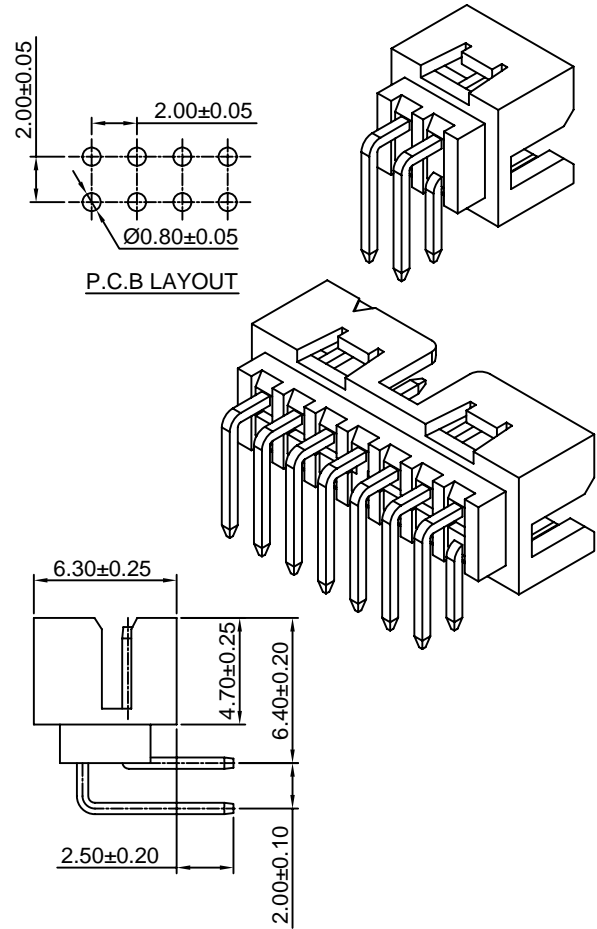
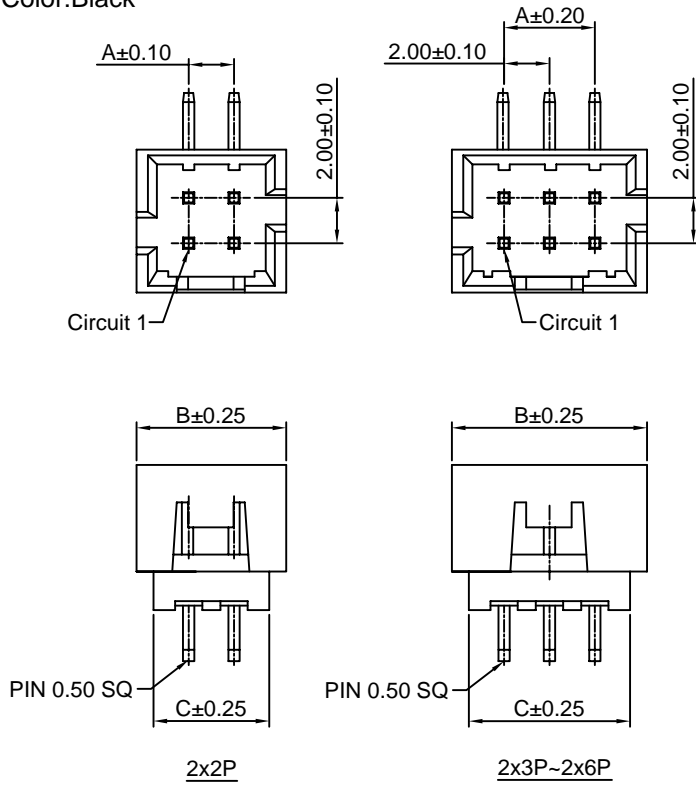

Ordering Information & Dimensions:

PART NO.	Dimensions		
	A	B	C
A2005WR-N-2x2P-A	2.00	6.65	5.00
A2005WR-N-2x3P-A	4.00	8.65	7.00
A2005WR-N-2x4P-A	6.00	10.65	9.00
A2005WR-N-2x5P-A	8.00	12.65	11.00
A2005WR-N-2x6P-A	10.00	14.65	13.00
A2005WR-N-2x7P-A	12.00	16.65	15.00
A2005WR-N-2x8P-A	14.00	18.65	17.00
A2005WR-N-2x9P-A	16.00	20.65	19.00
A2005WR-N-2x10P-A	18.00	22.65	21.00
A2005WR-N-2x11P-A	20.00	24.65	23.00
A2005WR-N-2x12P-A	22.00	26.65	25.00
A2005WR-N-2x13P-A	24.00	28.65	27.00
A2005WR-N-2x14P-A	26.00	30.65	29.00
A2005WR-N-2x15P-A	28.00	32.65	31.00
A2005WR-N-2x16P-A	30.00	34.65	33.00
A2005WR-N-2x17P-A	32.00	36.65	35.00
A2005WR-N-2x18P-A	34.00	38.65	37.00
A2005WR-N-2x19P-A	36.00	40.65	39.00
A2005WR-N-2x20P-A	38.00	42.65	41.00
A2005WR-N-2x21P-A	30.00	44.65	43.00
A2005WR-N-2x22P-A	32.00	46.65	45.00
A2005WR-N-2x23P-A	34.00	48.65	47.00
A2005WR-N-2x24P-A	36.00	50.65	49.00
A2005WR-N-2x25P-A	38.00	52.65	51.00

Unit: mm

A2005WR-N-2-B

2.00mm Pitch 90° Dual Row Box Header - B TYPE

Reference Informations:

- *Material: Pin: Brass/Gold over Nickel
Insulator: Nylon 6T, UL94V-0
- *Mates with CJT A2005 series Dual Row Housing
- *Color: Black

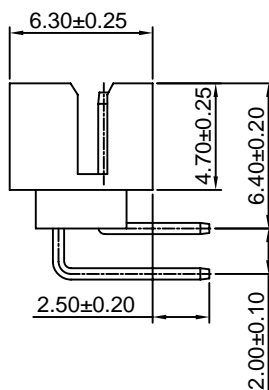
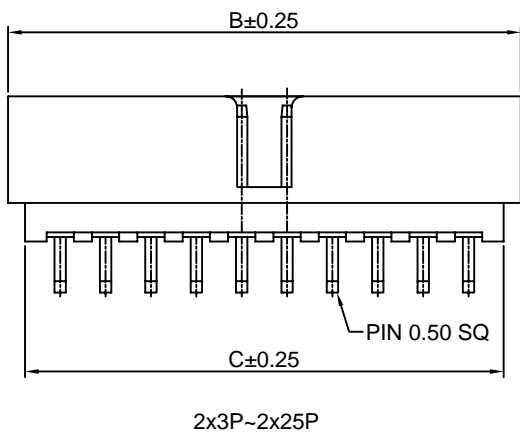
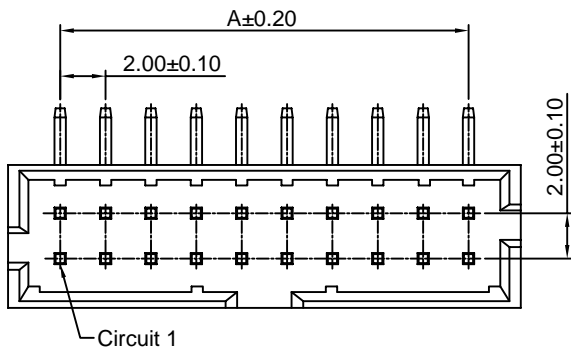
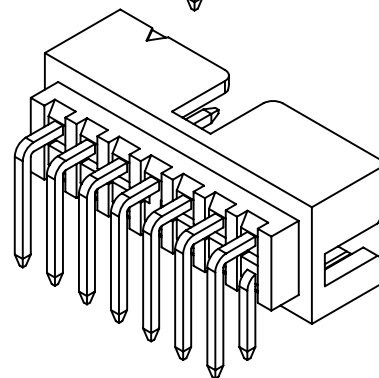
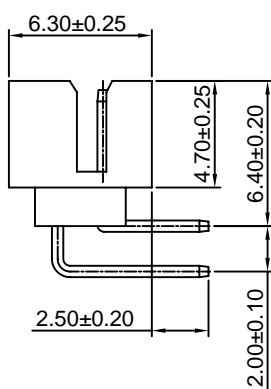
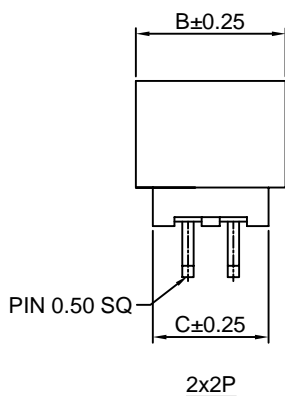
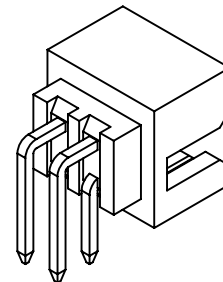
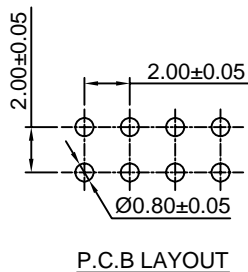
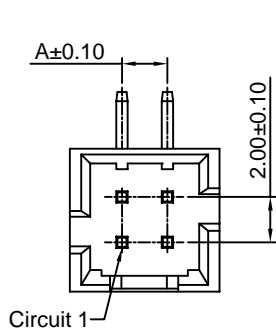

Ordering Information & Dimensions:

PART NO.	Dimensions		
	A	B	C
A2005WR-N-2x2P-B	2.00	6.65	5.00
A2005WR-N-2x3P-B	4.00	8.65	7.00
A2005WR-N-2x4P-B	6.00	10.65	9.00
A2005WR-N-2x5P-B	8.00	12.65	11.00
A2005WR-N-2x6P-B	10.00	14.65	13.00
A2005WR-N-2x7P-B	12.00	16.65	15.00
A2005WR-N-2x8P-B	14.00	18.65	17.00
A2005WR-N-2x9P-B	16.00	20.65	19.00
A2005WR-N-2x10P-B	18.00	22.65	21.00
A2005WR-N-2x11P-B	20.00	24.65	23.00
A2005WR-N-2x12P-B	22.00	26.65	25.00
A2005WR-N-2x13P-B	24.00	28.65	27.00
A2005WR-N-2x14P-B	26.00	30.65	29.00
A2005WR-N-2x15P-B	28.00	32.65	31.00
A2005WR-N-2x16P-B	30.00	34.65	33.00
A2005WR-N-2x17P-B	32.00	36.65	35.00
A2005WR-N-2x18P-B	34.00	38.65	37.00
A2005WR-N-2x19P-B	36.00	40.65	39.00
A2005WR-N-2x20P-B	38.00	42.65	41.00
A2005WR-N-2x21P-B	30.00	44.65	43.00
A2005WR-N-2x22P-B	32.00	46.65	45.00
A2005WR-N-2x23P-B	34.00	48.65	47.00
A2005WR-N-2x24P-B	36.00	50.65	49.00
A2005WR-N-2x25P-B	38.00	52.65	51.00

Unit: mm

A2005WV-N-2-FI

2.00mm Pitch 180° Dual Row Box Header

Reference Informations:

- *Material: Pin: Brass/Gold over Nickel
Insulator: Nylon 6T, UL94V-0
- *Mates with CJT A2005HB-N-FI series Dual Row Housing
- *Color: Black

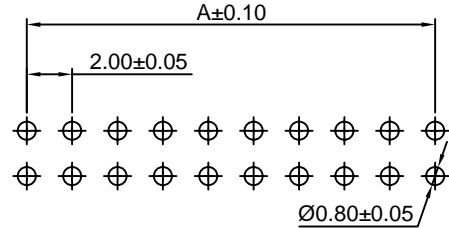
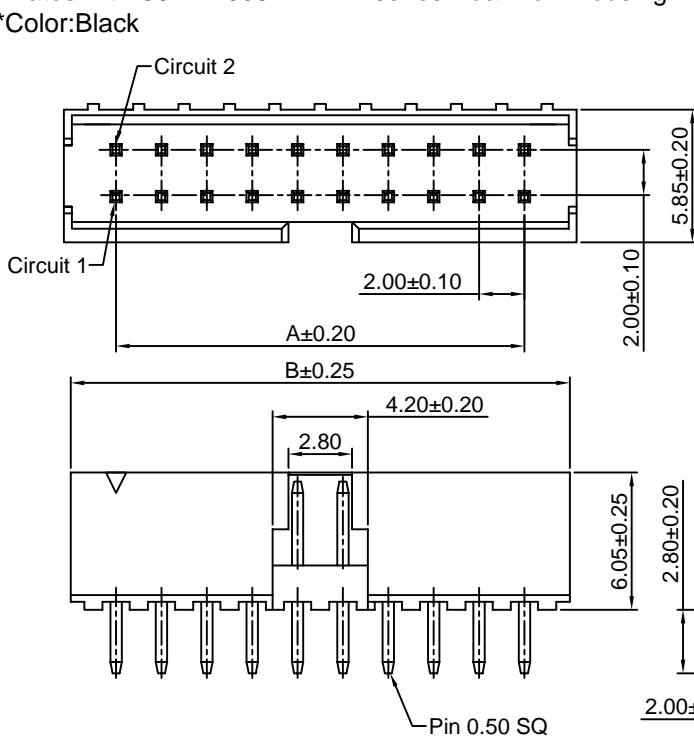

P.C.B LAYOUT

Ordering Information & Dimensions:

PART NO.	Dimensions	
	A	B
A2005WV-N-2x5P-FI	8.00	12.00
A2005WV-N-2x7P-FI	12.00	16.00
A2005WV-N-2x8P-FI	14.00	18.00
A2005WV-N-2x10P-FI	18.00	22.00
A2005WV-N-2x13P-FI	24.00	28.00
A2005WV-N-2x15P-FI	28.00	32.00
A2005WV-N-2x17P-FI	32.00	36.00
A2005WV-N-2x20P-FI	38.00	42.00
A2005WV-N-2x22P-FI	42.00	46.00
A2005WV-N-2x25P-FI	48.00	52.00
A2005WV-N-2x30P-FI	58.00	62.00

Unit: mm

A2005WV-N-S-2-FI

2.00mm Pitch 180° Dual Row Box Header - SMT TYPE

Reference Informations:

- *Material: Pin: Brass/Gold over Nickel
Insulator: Nylon 6T, UL94V-0
- *Mates with CJT A2005HB-N-FI series Dual Row Housing
- *Color: Black

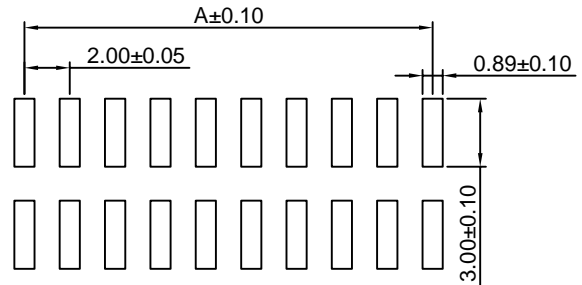
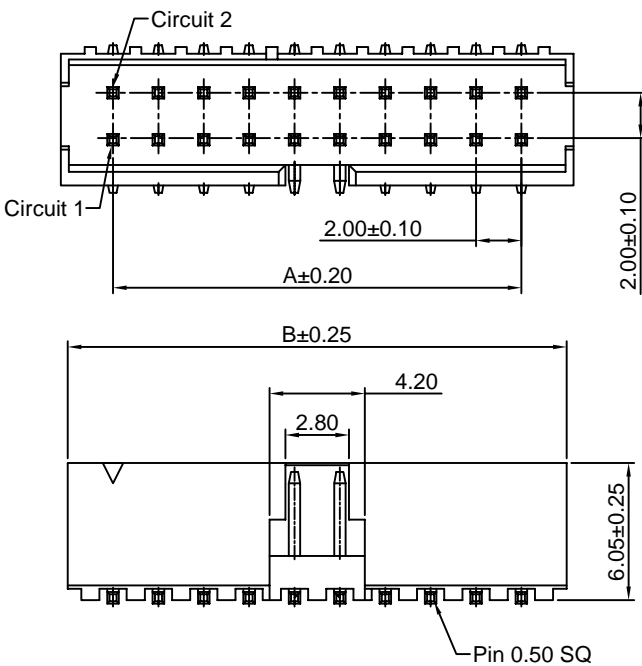

P.C.B LAYOUT

Ordering Information & Dimensions:

PART NO.	Dimensions	
	A	B
A2005WV-N-S-2x5P-FI	8.00	12.00
A2005WV-N-S-2x7P-FI	12.00	16.00
A2005WV-N-S-2x8P-FI	14.00	18.00
A2005WV-N-S-2x10P-FI	18.00	22.00
A2005WV-N-S-2x13P-FI	24.00	28.00
A2005WV-N-S-2x15P-FI	28.00	32.00
A2005WV-N-S-2x17P-FI	32.00	36.00
A2005WV-N-S-2x20P-FI	38.00	42.00
A2005WV-N-S-2x22P-FI	42.00	46.00
A2005WV-N-S-2x25P-FI	48.00	52.00
A2005WV-N-S-2x30P-FI	58.00	62.00

Unit: mm

A2005HWV

2.00mm Pitch 180° Single Row Female Header

Reference Informations:

- *Material:Pin:Phosphor Bronze/Gold over Nickel
Insulator:Nylon 66,UL94V-0
- *Mates with CJT A2005 series Single Row Pin Header
- *Color:Black

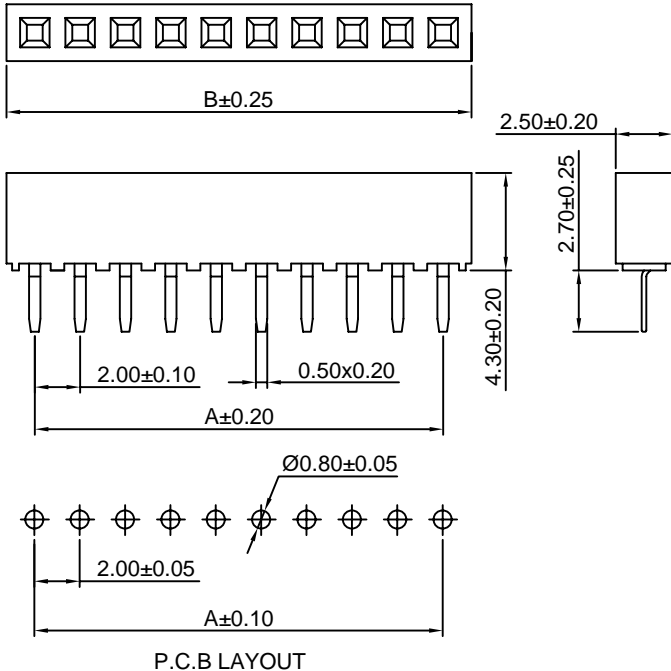
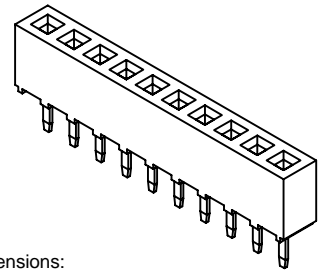

Ordering Information & Dimensions:

PART NO.	Dimensions		PART NO.	Dimensions	
	A	B		A	B
A2005HWV-2P	2.00	4.60	A2005HWV-22P	42.00	44.60
A2005HWV-3P	4.00	6.60	A2005HWV-23P	44.00	46.60
A2005HWV-4P	6.00	8.60	A2005HWV-24P	46.00	48.60
A2005HWV-5P	8.00	10.60	A2005HWV-25P	48.00	50.60
A2005HWV-6P	10.00	12.60	A2005HWV-26P	50.00	52.60
A2005HWV-7P	12.00	14.60	A2005HWV-27P	52.00	54.60
A2005HWV-8P	14.00	16.60	A2005HWV-28P	54.00	56.60
A2005HWV-9P	16.00	18.60	A2005HWV-29P	56.00	58.60
A2005HWV-10P	18.00	20.60	A2005HWV-30P	58.00	60.60
A2005HWV-11P	20.00	22.60	A2005HWV-31P	60.00	62.60
A2005HWV-12P	22.00	24.60	A2005HWV-32P	62.00	64.60
A2005HWV-13P	24.00	26.60	A2005HWV-33P	64.00	66.60
A2005HWV-14P	26.00	28.60	A2005HWV-34P	66.00	68.60
A2005HWV-15P	28.00	30.60	A2005HWV-35P	68.00	70.60
A2005HWV-16P	30.00	32.60	A2005HWV-36P	70.00	72.60
A2005HWV-17P	32.00	34.60	A2005HWV-37P	72.00	74.60
A2005HWV-18P	34.00	36.60	A2005HWV-38P	74.00	76.60
A2005HWV-19P	36.00	38.60	A2005HWV-39P	76.00	78.60
A2005HWV-20P	38.00	40.60	A2005HWV-40P	78.00	80.60
A2005HWV-21P	40.00	42.60			

Unit: mm

A2005HWR

2.00mm Pitch 90° Single Row Female Header

Reference Informations:

- *Material:Pin:Phosphor Bronze/Gold over Nickel
Insulator:Nylon 66,UL94V-0
- *Mates with CJT A2005 series Single Row Pin Header
- *Color:Black

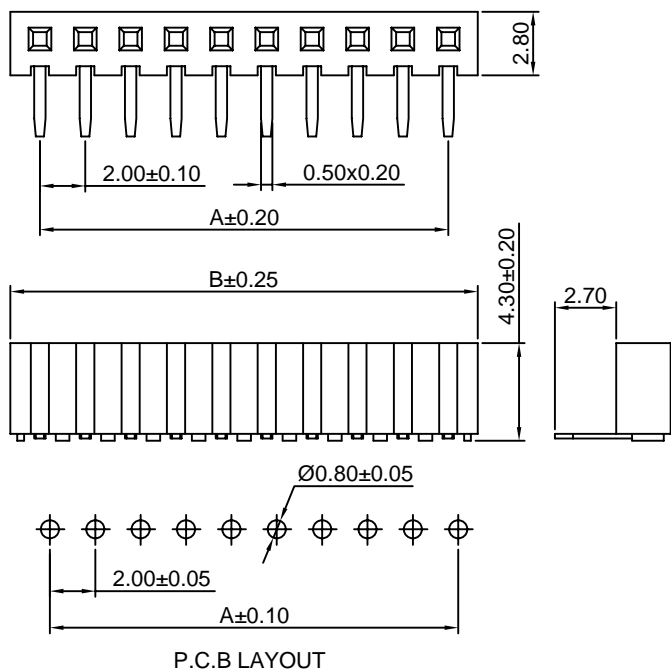
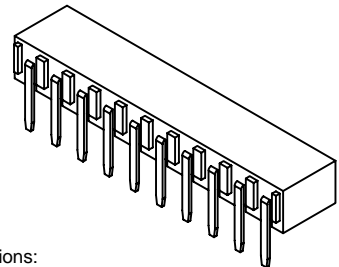

Ordering Information & Dimensions:

PART NO.	Dimensions		PART NO.	Dimensions	
	A	B		A	B
A2005HWR-2P	2.00	4.60	A2005HWR-22P	42.00	44.60
A2005HWR-3P	4.00	6.60	A2005HWR-23P	44.00	46.60
A2005HWR-4P	6.00	8.60	A2005HWR-24P	46.00	48.60
A2005HWR-5P	8.00	10.60	A2005HWR-25P	48.00	50.60
A2005HWR-6P	10.00	12.60	A2005HWR-26P	50.00	52.60
A2005HWR-7P	12.00	14.60	A2005HWR-27P	52.00	54.60
A2005HWR-8P	14.00	16.60	A2005HWR-28P	54.00	56.60
A2005HWR-9P	16.00	18.60	A2005HWR-29P	56.00	58.60
A2005HWR-10P	18.00	20.60	A2005HWR-30P	58.00	60.60
A2005HWR-11P	20.00	22.60	A2005HWR-31P	60.00	62.60
A2005HWR-12P	22.00	24.60	A2005HWR-32P	62.00	64.60
A2005HWR-13P	24.00	26.60	A2005HWR-33P	64.00	66.60
A2005HWR-14P	26.00	28.60	A2005HWR-34P	66.00	68.60
A2005HWR-15P	28.00	30.60	A2005HWR-35P	68.00	70.60
A2005HWR-16P	30.00	32.60	A2005HWR-36P	70.00	72.60
A2005HWR-17P	32.00	34.60	A2005HWR-37P	72.00	74.60
A2005HWR-18P	34.00	36.60	A2005HWR-38P	74.00	76.60
A2005HWR-19P	36.00	38.60	A2005HWR-39P	76.00	78.60
A2005HWR-20P	38.00	40.60	A2005HWR-40P	78.00	80.60
A2005HWR-21P	40.00	42.60			

Unit: mm

A2005HWV-A

2.00mm Pitch 180° Single Row Female Header - A TYPE

Reference Informations:

- *Material:Pin:Phophor Bronze/Gold over Nickel
Insulator:Nylon 6T,UL94V-0
- *Mates with CJT A2005 series Single Row Pin Header
- *Color:Black

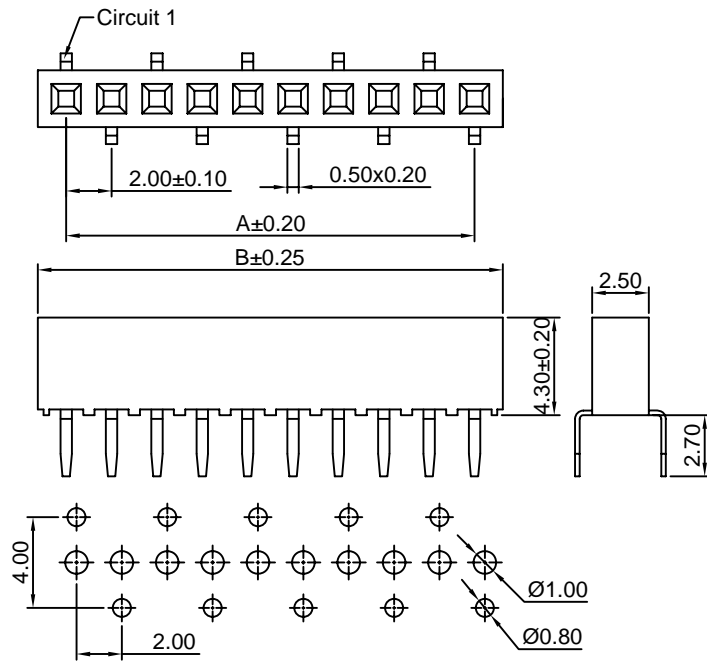

P.C.B LAYOUT

Ordering Information & Dimensions:

PART NO.	Dimensions		PART NO.	Dimensions	
	A	B		A	B
A2005HWV-2P-A	2.00	4.60	A2005HWV-22P-A	42.00	44.60
A2005HWV-3P-A	4.00	6.60	A2005HWV-23P-A	44.00	46.60
A2005HWV-4P-A	6.00	8.60	A2005HWV-24P-A	46.00	48.60
A2005HWV-5P-A	8.00	10.60	A2005HWV-25P-A	48.00	50.60
A2005HWV-6P-A	10.00	12.60	A2005HWV-26P-A	50.00	52.60
A2005HWV-7P-A	12.00	14.60	A2005HWV-27P-A	52.00	54.60
A2005HWV-8P-A	14.00	16.60	A2005HWV-28P-A	54.00	56.60
A2005HWV-9P-A	16.00	18.60	A2005HWV-29P-A	56.00	58.60
A2005HWV-10P-A	18.00	20.60	A2005HWV-30P-A	58.00	60.60
A2005HWV-11P-A	20.00	22.60	A2005HWV-31P-A	60.00	62.60
A2005HWV-12P-A	22.00	24.60	A2005HWV-32P-A	62.00	64.60
A2005HWV-13P-A	24.00	26.60	A2005HWV-33P-A	64.00	66.60
A2005HWV-14P-A	26.00	28.60	A2005HWV-34P-A	66.00	68.60
A2005HWV-15P-A	28.00	30.60	A2005HWV-35P-A	68.00	70.60
A2005HWV-16P-A	30.00	32.60	A2005HWV-36P-A	70.00	72.60
A2005HWV-17P-A	32.00	34.60	A2005HWV-37P-A	72.00	74.60
A2005HWV-18P-A	34.00	36.60	A2005HWV-38P-A	74.00	76.60
A2005HWV-19P-A	36.00	38.60	A2005HWV-39P-A	76.00	78.60
A2005HWV-20P-A	38.00	40.60	A2005HWV-40P-A	78.00	80.60
A2005HWV-21P-A	40.00	42.60			

Unit: mm

A2005HWV-B

2.00mm Pitch 180° Single Row Female Header - B TYPE

Reference Informations:

- *Material:Pin:Phophor Bronze/Gold over Nickel
Insulator:Nylon 6T,UL94V-0
- *Mates with CJT A2005 series Single Row Pin Header
- *Color:Black

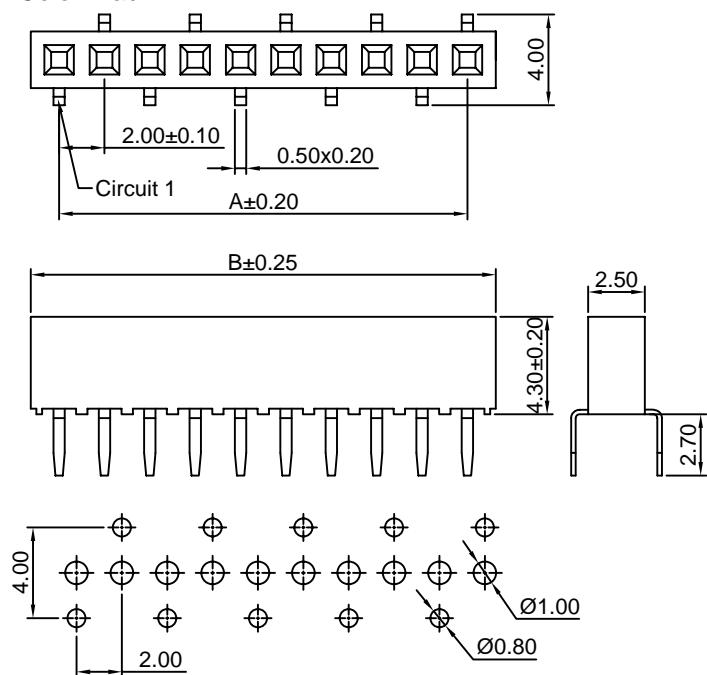

P.C.B LAYOUT

Ordering Information & Dimensions:

PART NO.	Dimensions		PART NO.	Dimensions	
	A	B		A	B
A2005HWV-2P-B	2.00	4.60	A2005HWV-22P-B	42.00	44.60
A2005HWV-3P-B	4.00	6.60	A2005HWV-23P-B	44.00	46.60
A2005HWV-4P-B	6.00	8.60	A2005HWV-24P-B	46.00	48.60
A2005HWV-5P-B	8.00	10.60	A2005HWV-25P-B	48.00	50.60
A2005HWV-6P-B	10.00	12.60	A2005HWV-26P-B	50.00	52.60
A2005HWV-7P-B	12.00	14.60	A2005HWV-27P-B	52.00	54.60
A2005HWV-8P-B	14.00	16.60	A2005HWV-28P-B	54.00	56.60
A2005HWV-9P-B	16.00	18.60	A2005HWV-29P-B	56.00	58.60
A2005HWV-10P-B	18.00	20.60	A2005HWV-30P-B	58.00	60.60
A2005HWV-11P-B	20.00	22.60	A2005HWV-31P-B	60.00	62.60
A2005HWV-12P-B	22.00	24.60	A2005HWV-32P-B	62.00	64.60
A2005HWV-13P-B	24.00	26.60	A2005HWV-33P-B	64.00	66.60
A2005HWV-14P-B	26.00	28.60	A2005HWV-34P-B	66.00	68.60
A2005HWV-15P-B	28.00	30.60	A2005HWV-35P-B	68.00	70.60
A2005HWV-16P-B	30.00	32.60	A2005HWV-36P-B	70.00	72.60
A2005HWV-17P-B	32.00	34.60	A2005HWV-37P-B	72.00	74.60
A2005HWV-18P-B	34.00	36.60	A2005HWV-38P-B	74.00	76.60
A2005HWV-19P-B	36.00	38.60	A2005HWV-39P-B	76.00	78.60
A2005HWV-20P-B	38.00	40.60	A2005HWV-40P-B	78.00	80.60
A2005HWV-21P-B	40.00	42.60			

Unit: mm

A2005HWV-C

2.00mm Pitch 180° Single Row Female Header - C TYPE

Reference Informations:

- *Material:Pin:Phosphor Bronze/Gold over Nickel
Insulator:Nylon 6T,UL94V-0
- *Mates with CJT A2005 series Single Row Pin Header
- *Color:Black

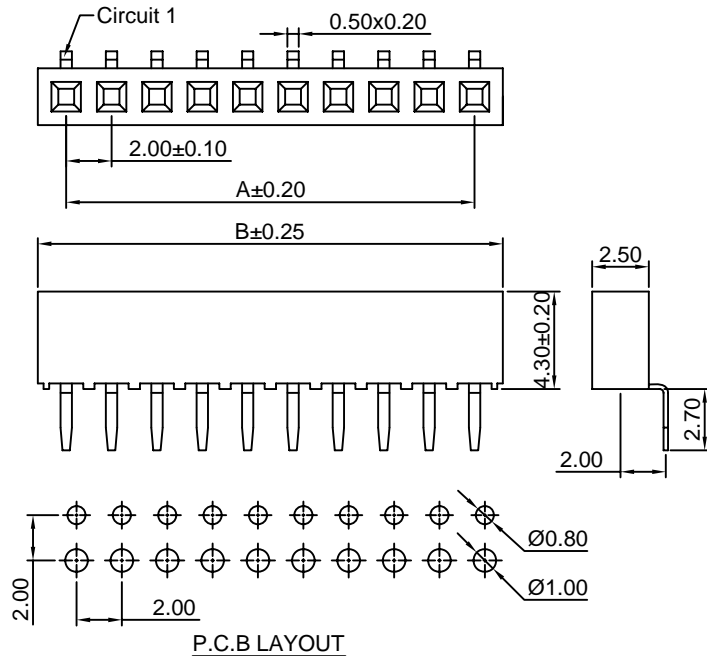

Ordering Information & Dimensions:

PART NO.	Dimensions		PART NO.	Dimensions	
	A	B		A	B
A2005HWV-2P-C	2.00	4.60	A2005HWV-22P-C	42.00	44.60
A2005HWV-3P-C	4.00	6.60	A2005HWV-23P-C	44.00	46.60
A2005HWV-4P-C	6.00	8.60	A2005HWV-24P-C	46.00	48.60
A2005HWV-5P-C	8.00	10.60	A2005HWV-25P-C	48.00	50.60
A2005HWV-6P-C	10.00	12.60	A2005HWV-26P-C	50.00	52.60
A2005HWV-7P-C	12.00	14.60	A2005HWV-27P-C	52.00	54.60
A2005HWV-8P-C	14.00	16.60	A2005HWV-28P-C	54.00	56.60
A2005HWV-9P-C	16.00	18.60	A2005HWV-29P-C	56.00	58.60
A2005HWV-10P-C	18.00	20.60	A2005HWV-30P-C	58.00	60.60
A2005HWV-11P-C	20.00	22.60	A2005HWV-31P-C	60.00	62.60
A2005HWV-12P-C	22.00	24.60	A2005HWV-32P-C	62.00	64.60
A2005HWV-13P-C	24.00	26.60	A2005HWV-33P-C	64.00	66.60
A2005HWV-14P-C	26.00	28.60	A2005HWV-34P-C	66.00	68.60
A2005HWV-15P-C	28.00	30.60	A2005HWV-35P-C	68.00	70.60
A2005HWV-16P-C	30.00	32.60	A2005HWV-36P-C	70.00	72.60
A2005HWV-17P-C	32.00	34.60	A2005HWV-37P-C	72.00	74.60
A2005HWV-18P-C	34.00	36.60	A2005HWV-38P-C	74.00	76.60
A2005HWV-19P-C	36.00	38.60	A2005HWV-39P-C	76.00	78.60
A2005HWV-20P-C	38.00	40.60	A2005HWV-40P-C	78.00	80.60
A2005HWV-21P-C	40.00	42.60			

Unit: mm

A2005HWV-S-A

2.00mm Pitch 180° Single Row Female Header - SMT A TYPE

Reference Informations:

- *Material:Pin:Phophor Bronze/Gold over Nickel
Insulator:Nylon 6T,UL94V-0
- *Mates with CJT A2005 series Single Row Pin Header
- *Color:Black

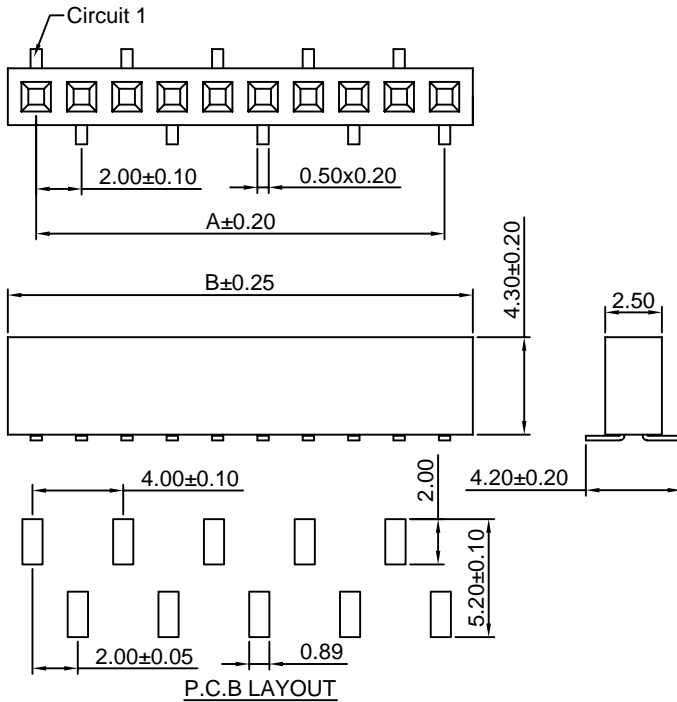
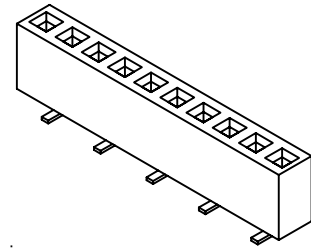

Ordering Information & Dimensions:

PART NO.	Dimensions		PART NO.	Dimensions	
	A	B		A	B
A2005HWV-S-2P-A	2.00	4.60	A2005HWV-S-22P-A	42.00	44.60
A2005HWV-S-3P-A	4.00	6.60	A2005HWV-S-23P-A	44.00	46.60
A2005HWV-S-4P-A	6.00	8.60	A2005HWV-S-24P-A	46.00	48.60
A2005HWV-S-5P-A	8.00	10.60	A2005HWV-S-25P-A	48.00	50.60
A2005HWV-S-6P-A	10.00	12.60	A2005HWV-S-26P-A	50.00	52.60
A2005HWV-S-7P-A	12.00	14.60	A2005HWV-S-27P-A	52.00	54.60
A2005HWV-S-8P-A	14.00	16.60	A2005HWV-S-28P-A	54.00	56.60
A2005HWV-S-9P-A	16.00	18.60	A2005HWV-S-29P-A	56.00	58.60
A2005HWV-S-10P-A	18.00	20.60	A2005HWV-S-30P-A	58.00	60.60
A2005HWV-S-11P-A	20.00	22.60	A2005HWV-S-31P-A	60.00	62.60
A2005HWV-S-12P-A	22.00	24.60	A2005HWV-S-32P-A	62.00	64.60
A2005HWV-S-13P-A	24.00	26.60	A2005HWV-S-33P-A	64.00	66.60
A2005HWV-S-14P-A	26.00	28.60	A2005HWV-S-34P-A	66.00	68.60
A2005HWV-S-15P-A	28.00	30.60	A2005HWV-S-35P-A	68.00	70.60
A2005HWV-S-16P-A	30.00	32.60	A2005HWV-S-36P-A	70.00	72.60
A2005HWV-S-17P-A	32.00	34.60	A2005HWV-S-37P-A	72.00	74.60
A2005HWV-S-18P-A	34.00	36.60	A2005HWV-S-38P-A	74.00	76.60
A2005HWV-S-19P-A	36.00	38.60	A2005HWV-S-39P-A	76.00	78.60
A2005HWV-S-20P-A	38.00	40.60	A2005HWV-S-40P-A	78.00	80.60
A2005HWV-S-21P-A	40.00	42.60			

Unit: mm

A2005HWV-S-B

2.00mm Pitch 180° Single Row Female Header - SMT B TYPE

Reference Informations:

- *Material:Pin:Phophor Bronze/Gold over Nickel
Insulator:Nylon 6T,UL94V-0
- *Mates with CJT A2005 series Single Row Pin Header
- *Color:Black

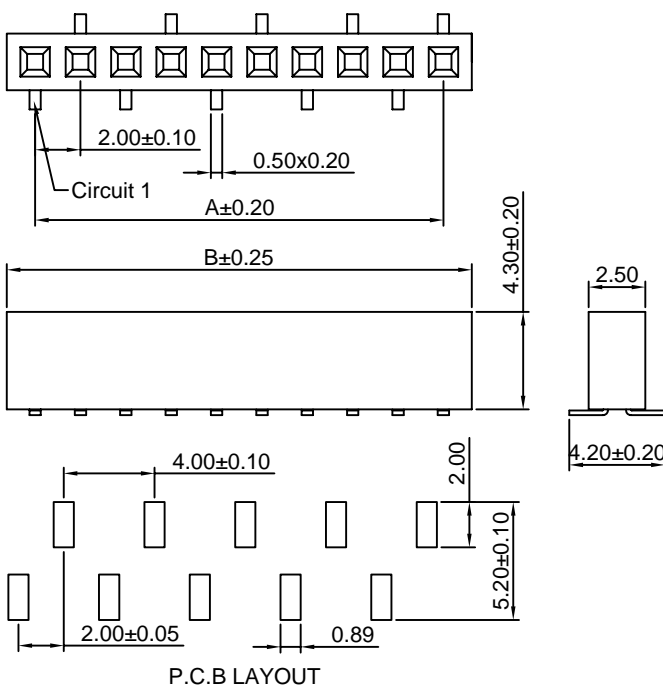
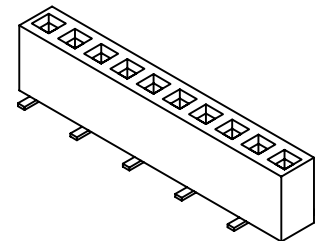

Ordering Information & Dimensions:

PART NO.	Dimensions		P-BART NO.	Dimensions	
	A	B		A	B
A2005HWV-S-2P-B	2.00	4.60	A2005HWV-S-22P-B	42.00	44.60
A2005HWV-S-3P-B	4.00	6.60	A2005HWV-S-23P-B	44.00	46.60
A2005HWV-S-4P-B	6.00	8.60	A2005HWV-S-24P-B	46.00	48.60
A2005HWV-S-5P-B	8.00	10.60	A2005HWV-S-25P-B	48.00	50.60
A2005HWV-S-6P-B	10.00	12.60	A2005HWV-S-26P-B	50.00	52.60
A2005HWV-S-7P-B	12.00	14.60	A2005HWV-S-27P-B	52.00	54.60
A2005HWV-S-8P-B	14.00	16.60	A2005HWV-S-28P-B	54.00	56.60
A2005HWV-S-9P-B	16.00	18.60	A2005HWV-S-29P-B	56.00	58.60
A2005HWV-S-10P-B	18.00	20.60	A2005HWV-S-30P-B	58.00	60.60
A2005HWV-S-11P-B	20.00	22.60	A2005HWV-S-31P-B	60.00	62.60
A2005HWV-S-12P-B	22.00	24.60	A2005HWV-S-32P-B	62.00	64.60
A2005HWV-S-13P-B	24.00	26.60	A2005HWV-S-33P-B	64.00	66.60
A2005HWV-S-14P-B	26.00	28.60	A2005HWV-S-34P-B	66.00	68.60
A2005HWV-S-15P-B	28.00	30.60	A2005HWV-S-35P-B	68.00	70.60
A2005HWV-S-16P-B	30.00	32.60	A2005HWV-S-36P-B	70.00	72.60
A2005HWV-S-17P-B	32.00	34.60	A2005HWV-S-37P-B	72.00	74.60
A2005HWV-S-18P-B	34.00	36.60	A2005HWV-S-38P-B	74.00	76.60
A2005HWV-S-19P-B	36.00	38.60	A2005HWV-S-39P-B	76.00	78.60
A2005HWV-S-20P-B	38.00	40.60	A2005HWV-S-40P-B	78.00	80.60
A2005HWV-S-21P-B	40.00	42.60			

Unit: mm

A2005HWV-2

2.00mm Pitch 180° Dual Row Female Header

Reference Informations:

- *Material:Pin:Phosphor Bronze/Gold over Nickel
Insulator:Nylon 66,UL94V-0
- *Mates with CJT A2005 series Dual Row Pin Header
- *Color:Black

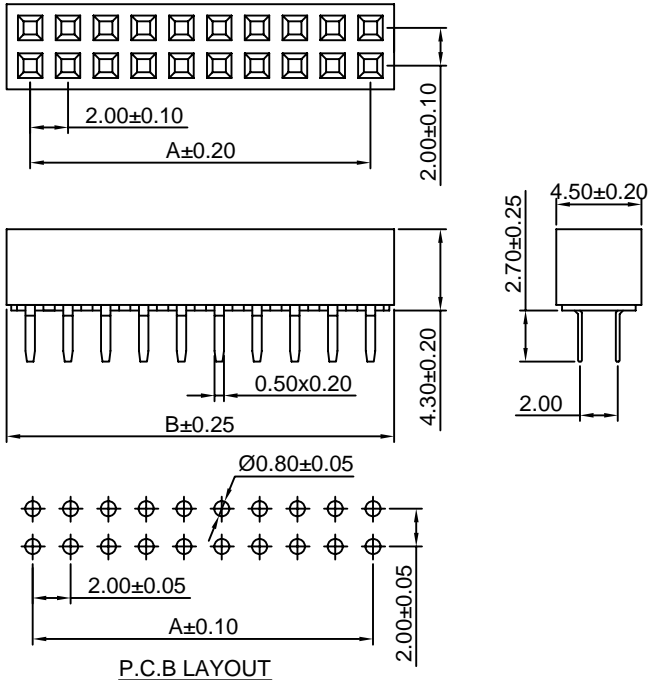
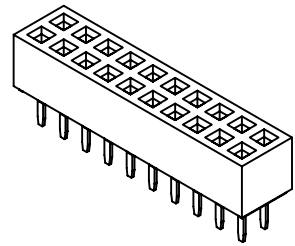

Ordering Information & Dimensions:

PART NO.	Dimensions		PART NO.	Dimensions	
	A	B		A	B
A2005HWV-2x2P	2.00	4.60	A2005HWV-2x22P	42.00	44.60
A2005HWV-2x3P	4.00	6.60	A2005HWV-2x23P	44.00	46.60
A2005HWV-2x4P	6.00	8.60	A2005HWV-2x24P	46.00	48.60
A2005HWV-2x5P	8.00	10.60	A2005HWV-2x25P	48.00	50.60
A2005HWV-2x6P	10.00	12.60	A2005HWV-2x26P	50.00	52.60
A2005HWV-2x7P	12.00	14.60	A2005HWV-2x27P	52.00	54.60
A2005HWV-2x8P	14.00	16.60	A2005HWV-2x28P	54.00	56.60
A2005HWV-2x9P	16.00	18.60	A2005HWV-2x29P	56.00	58.60
A2005HWV-2x10P	18.00	20.60	A2005HWV-2x30P	58.00	60.60
A2005HWV-2x11P	20.00	22.60	A2005HWV-2x31P	60.00	62.60
A2005HWV-2x12P	22.00	24.60	A2005HWV-2x32P	62.00	64.60
A2005HWV-2x13P	24.00	26.60	A2005HWV-2x33P	64.00	66.60
A2005HWV-2x14P	26.00	28.60	A2005HWV-2x34P	66.00	68.60
A2005HWV-2x15P	28.00	30.60	A2005HWV-2x35P	68.00	70.60
A2005HWV-2x16P	30.00	32.60	A2005HWV-2x36P	70.00	72.60
A2005HWV-2x17P	32.00	34.60	A2005HWV-2x37P	72.00	74.60
A2005HWV-2x18P	34.00	36.60	A2005HWV-2x38P	74.00	76.60
A2005HWV-2x19P	36.00	38.60	A2005HWV-2x39P	76.00	78.60
A2005HWV-2x20P	38.00	40.60	A2005HWV-2x40P	78.00	80.60
A2005HWV-2x21P	40.00	42.60			

Unit: mm

A2005HWR-2

2.00mm Pitch 90° Dual Row Female Header

Reference Informations:

- *Material:Pin:Phosphor Bronze/Gold over Nickel
Insulator:Nylon 66,UL94V-0
- *Mates with CJT A2005 series Dual Row Pin Header
- *Color:Black

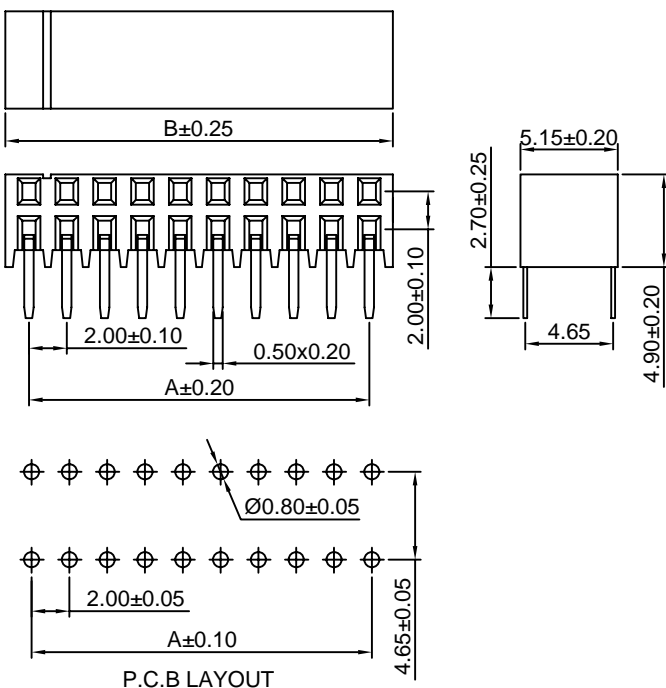

Ordering Information & Dimensions:

PART NO.	Dimensions		PART NO.	Dimensions	
	A	B		A	B
A2005HWR-2x2P	2.00	4.60	A2005HWR-2x22P	42.00	44.60
A2005HWR-2x3P	4.00	6.60	A2005HWR-2x23P	44.00	46.60
A2005HWR-2x4P	6.00	8.60	A2005HWR-2x24P	46.00	48.60
A2005HWR-2x5P	8.00	10.60	A2005HWR-2x25P	48.00	50.60
A2005HWR-2x6P	10.00	12.60	A2005HWR-2x26P	50.00	52.60
A2005HWR-2x7P	12.00	14.60	A2005HWR-2x27P	52.00	54.60
A2005HWR-2x8P	14.00	16.60	A2005HWR-2x28P	54.00	56.60
A2005HWR-2x9P	16.00	18.60	A2005HWR-2x29P	56.00	58.60
A2005HWR-2x10P	18.00	20.60	A2005HWR-2x30P	58.00	60.60
A2005HWR-2x11P	20.00	22.60	A2005HWR-2x31P	60.00	62.60
A2005HWR-2x12P	22.00	24.60	A2005HWR-2x32P	62.00	64.60
A2005HWR-2x13P	24.00	26.60	A2005HWR-2x33P	64.00	66.60
A2005HWR-2x14P	26.00	28.60	A2005HWR-2x34P	66.00	68.60
A2005HWR-2x15P	28.00	30.60	A2005HWR-2x35P	68.00	70.60
A2005HWR-2x16P	30.00	32.60	A2005HWR-2x36P	70.00	72.60
A2005HWR-2x17P	32.00	34.60	A2005HWR-2x37P	72.00	74.60
A2005HWR-2x18P	34.00	36.60	A2005HWR-2x38P	74.00	76.60
A2005HWR-2x19P	36.00	38.60	A2005HWR-2x39P	76.00	78.60
A2005HWR-2x20P	38.00	40.60	A2005HWR-2x40P	78.00	80.60
A2005HWR-2x21P	40.00	42.60			

Unit: mm

A2005HWR-S-2

2.00mm Pitch 90° Dual Row Female Header - SMT TYPE

Reference Informations:

- *Material:Pin:Phophor Bronze/Gold over Nickel
Insulator:Nylon 6T,UL94V-0
- *Mates with CJT A2005 series Dual Row Pin Header
- *Color:Black

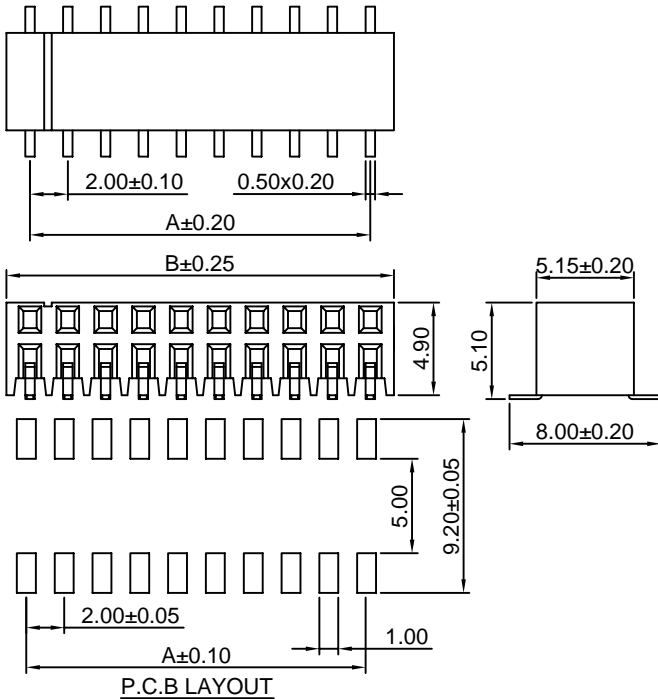

Ordering Information & Dimensions:

PART NO.	Dimensions		PART NO.	Dimensions	
	A	B		A	B
A2005HWR-S-2x2P	2.00	4.60	A2005HWR-S-2x22P	42.00	44.60
A2005HWR-S-2x3P	4.00	6.60	A2005HWR-S-2x23P	44.00	46.60
A2005HWR-S-2x4P	6.00	8.60	A2005HWR-S-2x24P	46.00	48.60
A2005HWR-S-2x5P	8.00	10.60	A2005HWR-S-2x25P	48.00	50.60
A2005HWR-S-2x6P	10.00	12.60	A2005HWR-S-2x26P	50.00	52.60
A2005HWR-S-2x7P	12.00	14.60	A2005HWR-S-2x27P	52.00	54.60
A2005HWR-S-2x8P	14.00	16.60	A2005HWR-S-2x28P	54.00	56.60
A2005HWR-S-2x9P	16.00	18.60	A2005HWR-S-2x29P	56.00	58.60
A2005HWR-S-2x10P	18.00	20.60	A2005HWR-S-2x30P	58.00	60.60
A2005HWR-S-2x11P	20.00	22.60	A2005HWR-S-2x31P	60.00	62.60
A2005HWR-S-2x12P	22.00	24.60	A2005HWR-S-2x32P	62.00	64.60
A2005HWR-S-2x13P	24.00	26.60	A2005HWR-S-2x33P	64.00	66.60
A2005HWR-S-2x14P	26.00	28.60	A2005HWR-S-2x34P	66.00	68.60
A2005HWR-S-2x15P	28.00	30.60	A2005HWR-S-2x35P	68.00	70.60
A2005HWR-S-2x16P	30.00	32.60	A2005HWR-S-2x36P	70.00	72.60
A2005HWR-S-2x17P	32.00	34.60	A2005HWR-S-2x37P	72.00	74.60
A2005HWR-S-2x18P	34.00	36.60	A2005HWR-S-2x38P	74.00	76.60
A2005HWR-S-2x19P	36.00	38.60	A2005HWR-S-2x39P	76.00	78.60
A2005HWR-S-2x20P	38.00	40.60	A2005HWR-S-2x40P	78.00	80.60
A2005HWR-S-2x21P	40.00	42.60			

Unit: mm

A2005HWR-S-F-2

2.00mm Pitch 90° Dual Row Female Header - SMT TYPE

Reference Informations:

- *Material:Pin:Phophor Bronze/Gold over Nickel
Insulator:Nylon 6T,UL94V-0
- *Mates with CJT A2005 series Dual Row Pin Header
- *Color:Black

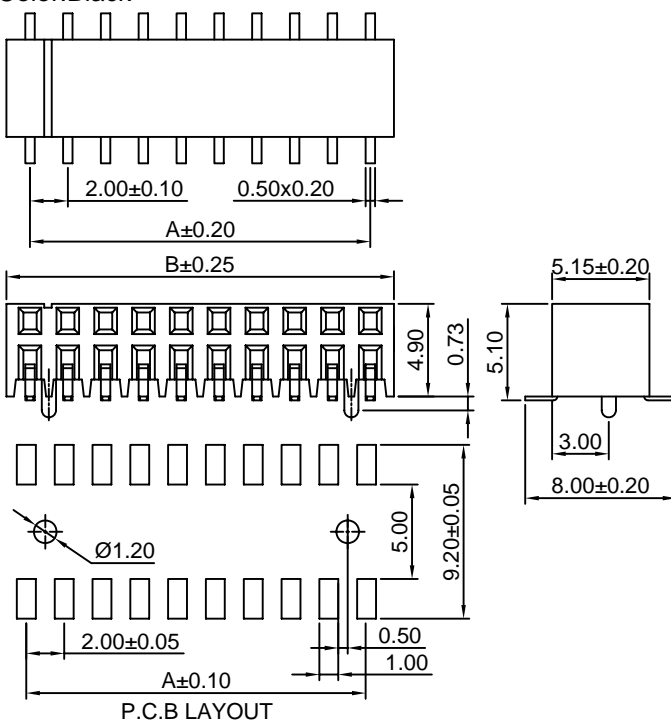

Ordering Information & Dimensions:

PART NO.	Dimensions		PART NO.	Dimensions	
	A	B		A	B
A2005HWR-S-F-2x2P	2.00	4.60	A2005HWR-S-F-2x22P	42.00	44.60
A2005HWR-S-F-2x3P	4.00	6.60	A2005HWR-S-F-2x23P	44.00	46.60
A2005HWR-S-F-2x4P	6.00	8.60	A2005HWR-S-F-2x24P	46.00	48.60
A2005HWR-S-F-2x5P	8.00	10.60	A2005HWR-S-F-2x25P	48.00	50.60
A2005HWR-S-F-2x6P	10.00	12.60	A2005HWR-S-F-2x26P	50.00	52.60
A2005HWR-S-F-2x7P	12.00	14.60	A2005HWR-S-F-2x27P	52.00	54.60
A2005HWR-S-F-2x8P	14.00	16.60	A2005HWR-S-F-2x28P	54.00	56.60
A2005HWR-S-F-2x9P	16.00	18.60	A2005HWR-S-F-2x29P	56.00	58.60
A2005HWR-S-F-2x10P	18.00	20.60	A2005HWR-S-F-2x30P	58.00	60.60
A2005HWR-S-F-2x11P	20.00	22.60	A2005HWR-S-F-2x31P	60.00	62.60
A2005HWR-S-F-2x12P	22.00	24.60	A2005HWR-S-F-2x32P	62.00	64.60
A2005HWR-S-F-2x13P	24.00	26.60	A2005HWR-S-F-2x33P	64.00	66.60
A2005HWR-S-F-2x14P	26.00	28.60	A2005HWR-S-F-2x34P	66.00	68.60
A2005HWR-S-F-2x15P	28.00	30.60	A2005HWR-S-F-2x35P	68.00	70.60
A2005HWR-S-F-2x16P	30.00	32.60	A2005HWR-S-F-2x36P	70.00	72.60
A2005HWR-S-F-2x17P	32.00	34.60	A2005HWR-S-F-2x37P	72.00	74.60
A2005HWR-S-F-2x18P	34.00	36.60	A2005HWR-S-F-2x38P	74.00	76.60
A2005HWR-S-F-2x19P	36.00	38.60	A2005HWR-S-F-2x39P	76.00	78.60
A2005HWR-S-F-2x20P	38.00	40.60	A2005HWR-S-F-2x40P	78.00	80.60
A2005HWR-S-F-2x21P	40.00	42.60			

Unit: mm

A2005HWVA-2

2.00mm Pitch 180° Dual Row Female Header

Reference Informations:

- *Material:Pin:Phosphor Bronze/Gold over Nickel
Insulator:Nylon 6T,UL94V-0
- *Mates with CJT A2005 series Dual Row Pin Header
- *Color:Black

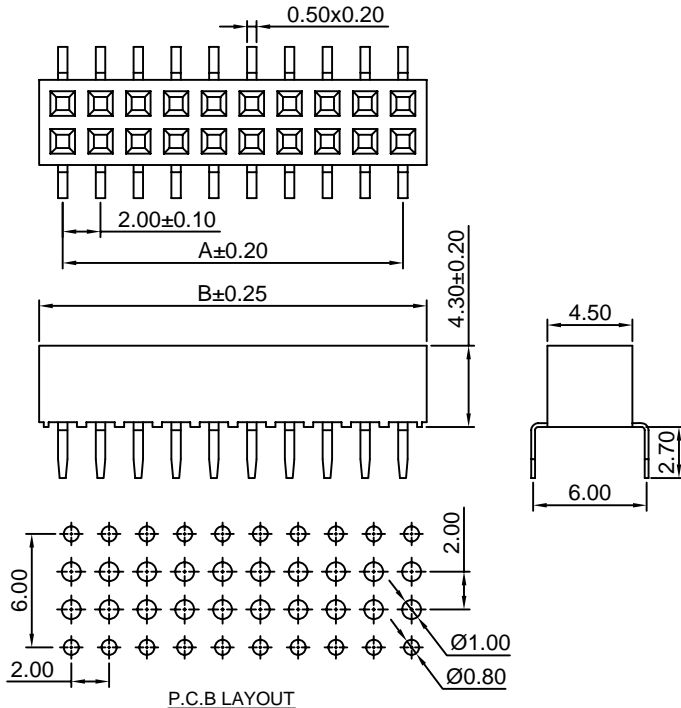

Ordering Information & Dimensions:

PART NO.	Dimensions		PART NO.	Dimensions	
	A	B		A	B
A2005HWVA-2x2P	2.00	4.60	A2005HWVA-2x22P	42.00	44.60
A2005HWVA-2x3P	4.00	6.60	A2005HWVA-2x23P	44.00	46.60
A2005HWVA-2x4P	6.00	8.60	A2005HWVA-2x24P	46.00	48.60
A2005HWVA-2x5P	8.00	10.60	A2005HWVA-2x25P	48.00	50.60
A2005HWVA-2x6P	10.00	12.60	A2005HWVA-2x26P	50.00	52.60
A2005HWVA-2x7P	12.00	14.60	A2005HWVA-2x27P	52.00	54.60
A2005HWVA-2x8P	14.00	16.60	A2005HWVA-2x28P	54.00	56.60
A2005HWVA-2x9P	16.00	18.60	A2005HWVA-2x29P	56.00	58.60
A2005HWVA-2x10P	18.00	20.60	A2005HWVA-2x30P	58.00	60.60
A2005HWVA-2x11P	20.00	22.60	A2005HWVA-2x31P	60.00	62.60
A2005HWVA-2x12P	22.00	24.60	A2005HWVA-2x32P	62.00	64.60
A2005HWVA-2x13P	24.00	26.60	A2005HWVA-2x33P	64.00	66.60
A2005HWVA-2x14P	26.00	28.60	A2005HWVA-2x34P	66.00	68.60
A2005HWVA-2x15P	28.00	30.60	A2005HWVA-2x35P	68.00	70.60
A2005HWVA-2x16P	30.00	32.60	A2005HWVA-2x36P	70.00	72.60
A2005HWVA-2x17P	32.00	34.60	A2005HWVA-2x37P	72.00	74.60
A2005HWVA-2x18P	34.00	36.60	A2005HWVA-2x38P	74.00	76.60
A2005HWVA-2x19P	36.00	38.60	A2005HWVA-2x39P	76.00	78.60
A2005HWVA-2x20P	38.00	40.60	A2005HWVA-2x40P	78.00	80.60
A2005HWVA-2x21P	40.00	42.60			

Unit: mm

A2005HWVB-2x10P

2.00mm pitch 180° Box Female Header

Reference Informations:

- *Material:Pin:Brass/Gold over Nickel
Insulator:Nylon 66,UL94V-0
- *Mates with CJT A2005 series Dual Row Pin Header
- *Color:Black

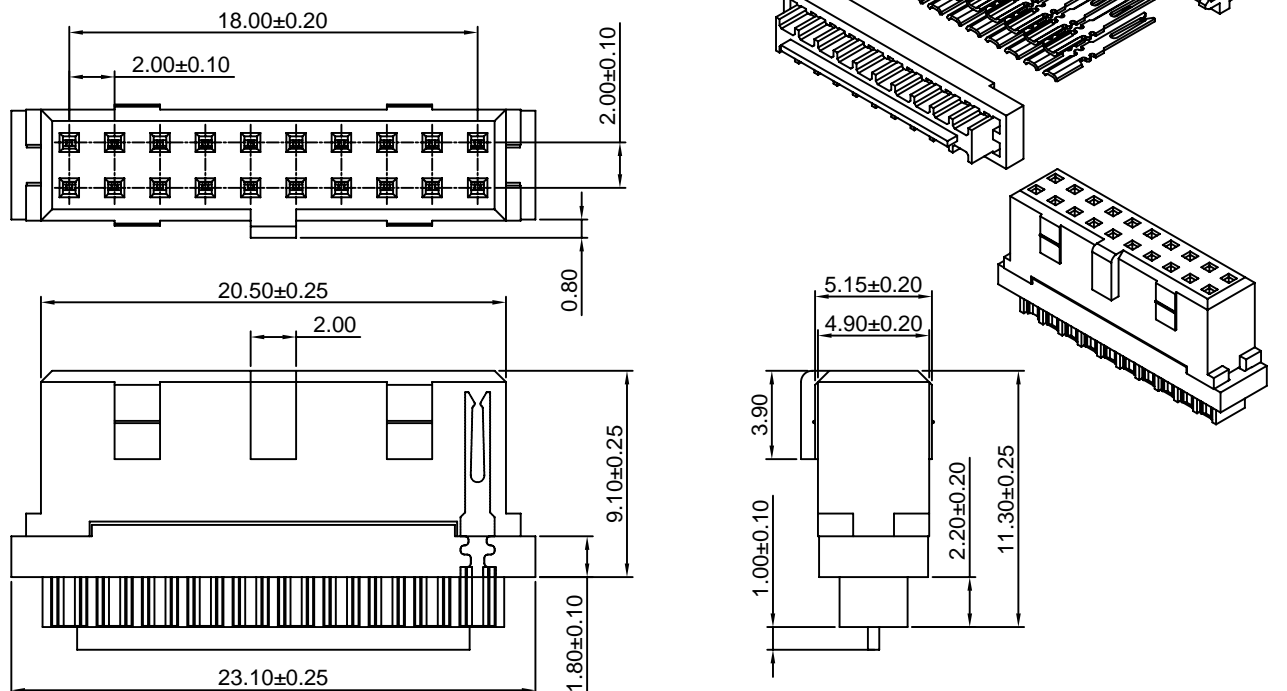

A2005HWV-3

2.00mm Pitch 180° Triple Row Female Header

Reference Informations:

- *Material:Pin:Phosphor Bronze/Gold over Nickel
Insulator:Nylon 6T,UL94V-0
- *Color:Black

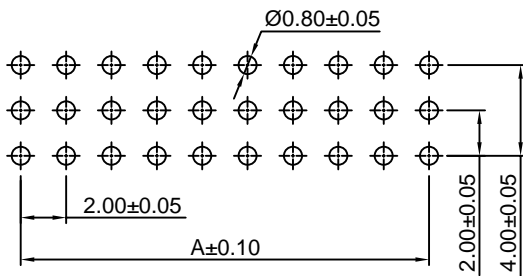
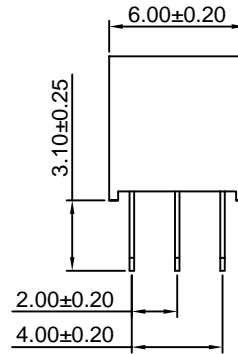
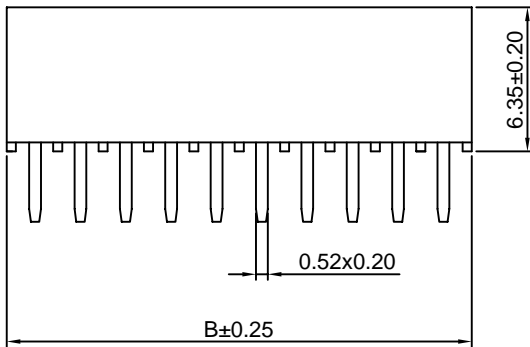
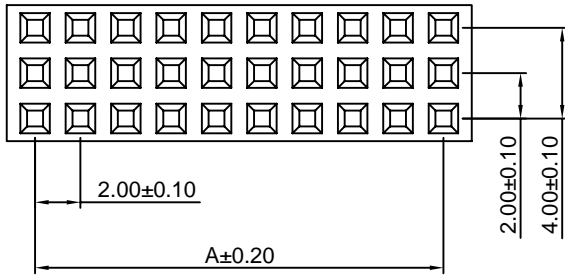
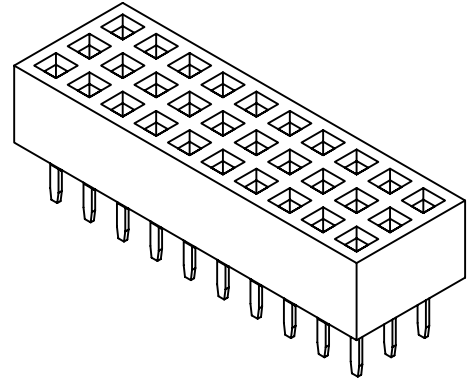

P.C.B LAYOUT

Ordering Information & Dimensions:

PART NO.	Dimensions		PART NO.	Dimensions	
	A	B		A	B
A2005HWV-3x2P	2.00	4.30	A2005HWV-3x22P	42.00	44.30
A2005HWV-3x3P	4.00	6.30	A2005HWV-3x23P	44.00	46.30
A2005HWV-3x4P	6.00	8.30	A2005HWV-3x24P	46.00	48.30
A2005HWV-3x5P	8.00	10.30	A2005HWV-3x25P	48.00	50.30
A2005HWV-3x6P	10.00	12.30	A2005HWV-3x26P	50.00	52.30
A2005HWV-3x7P	12.00	14.30	A2005HWV-3x27P	52.00	54.30
A2005HWV-3x8P	14.00	16.30	A2005HWV-3x28P	54.00	56.30
A2005HWV-3x9P	16.00	18.30	A2005HWV-3x29P	56.00	58.30
A2005HWV-3x10P	18.00	20.30	A2005HWV-3x30P	58.00	60.30
A2005HWV-3x11P	20.00	22.30	A2005HWV-3x31P	60.00	62.30
A2005HWV-3x12P	22.00	24.30	A2005HWV-3x32P	62.00	64.30
A2005HWV-3x13P	24.00	26.30	A2005HWV-3x33P	64.00	66.30
A2005HWV-3x14P	26.00	28.30	A2005HWV-3x34P	66.00	68.30
A2005HWV-3x15P	28.00	30.30	A2005HWV-3x35P	68.00	70.30
A2005HWV-3x16P	30.00	32.30	A2005HWV-3x36P	70.00	72.30
A2005HWV-3x17P	32.00	34.30	A2005HWV-3x37P	72.00	74.30
A2005HWV-3x18P	34.00	36.30	A2005HWV-3x38P	74.00	76.30
A2005HWV-3x19P	36.00	38.30	A2005HWV-3x39P	76.00	78.30
A2005HWV-3x20P	38.00	40.30	A2005HWV-3x40P	78.00	80.30
A2005HWV-3x21P	40.00	42.30			

Unit: mm

A2005HWV-4

2.00mm Pitch 180° Four Row Female Header

Reference Informations:

- *Material: Pin: Phosphor Bronze/Gold over Nickel
Insulator: Nylon 6T, UL94V-0
- *Color: Black

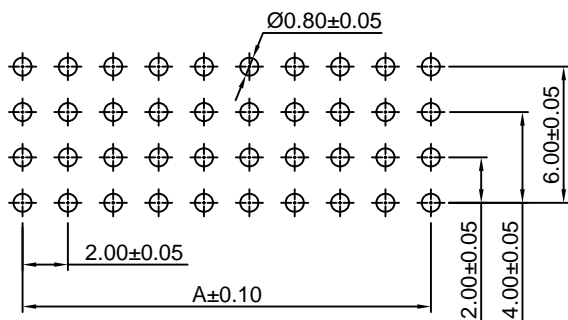
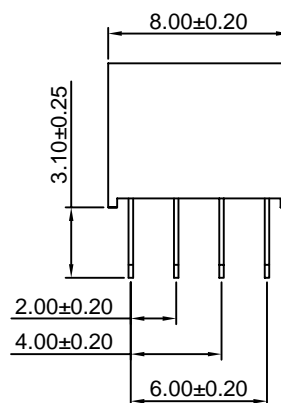
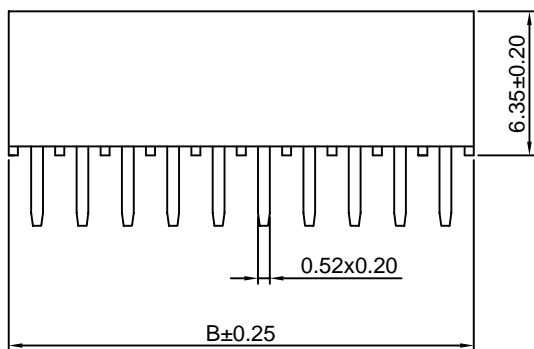
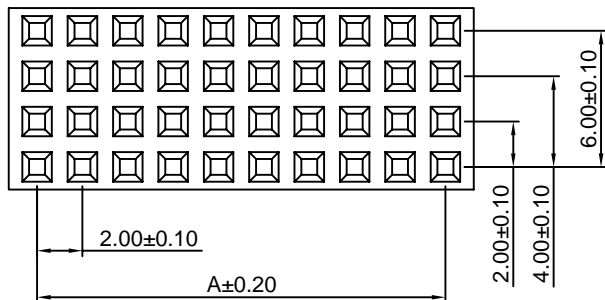
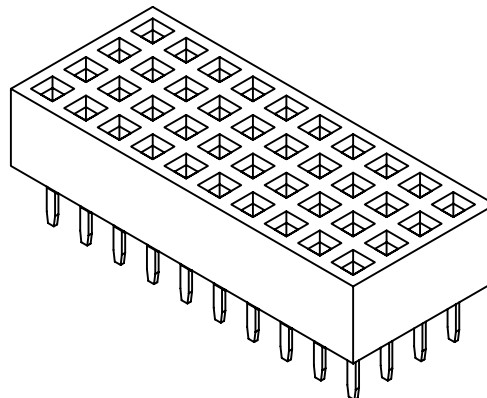

P.C.B LAYOUT

Ordering Information & Dimensions:

PART NO.	Dimensions		PART NO.	Dimensions	
	A	B		A	B
A2005HWV-4x2P	2.00	4.30	A2005HWV-4x22P	42.00	44.30
A2005HWV-4x3P	4.00	6.30	A2005HWV-4x23P	44.00	46.30
A2005HWV-4x4P	6.00	8.30	A2005HWV-4x24P	46.00	48.30
A2005HWV-4x5P	8.00	10.30	A2005HWV-4x25P	48.00	50.30
A2005HWV-4x6P	10.00	12.30	A2005HWV-4x26P	50.00	52.30
A2005HWV-4x7P	12.00	14.30	A2005HWV-4x27P	52.00	54.30
A2005HWV-4x8P	14.00	16.30	A2005HWV-4x28P	54.00	56.30
A2005HWV-4x9P	16.00	18.30	A2005HWV-4x29P	56.00	58.30
A2005HWV-4x10P	18.00	20.30	A2005HWV-4x30P	58.00	60.30
A2005HWV-4x11P	20.00	22.30	A2005HWV-4x31P	60.00	62.30
A2005HWV-4x12P	22.00	24.30	A2005HWV-4x32P	62.00	64.30
A2005HWV-4x13P	24.00	26.30	A2005HWV-4x33P	64.00	66.30
A2005HWV-4x14P	26.00	28.30	A2005HWV-4x34P	66.00	68.30
A2005HWV-4x15P	28.00	30.30	A2005HWV-4x35P	68.00	70.30
A2005HWV-4x16P	30.00	32.30	A2005HWV-4x36P	70.00	72.30
A2005HWV-4x17P	32.00	34.30	A2005HWV-4x37P	72.00	74.30
A2005HWV-4x18P	34.00	36.30	A2005HWV-4x38P	74.00	76.30
A2005HWV-4x19P	36.00	38.30	A2005HWV-4x39P	76.00	78.30
A2005HWV-4x20P	38.00	40.30	A2005HWV-4x40P	78.00	80.30
A2005HWV-4x21P	40.00	42.30			

Unit: mm

A2005WV

2.00mm pitch 180° Single Row Pin Header

Reference Informations:

- *Material: Pin: Brass/Gold over Nickel
Insulator: Nylon 6T, UL94V-0
- *Mates with CJT A2005 series Single Row Female Header
- *Optional Dim. available but MOQ requested
- *Color: Black

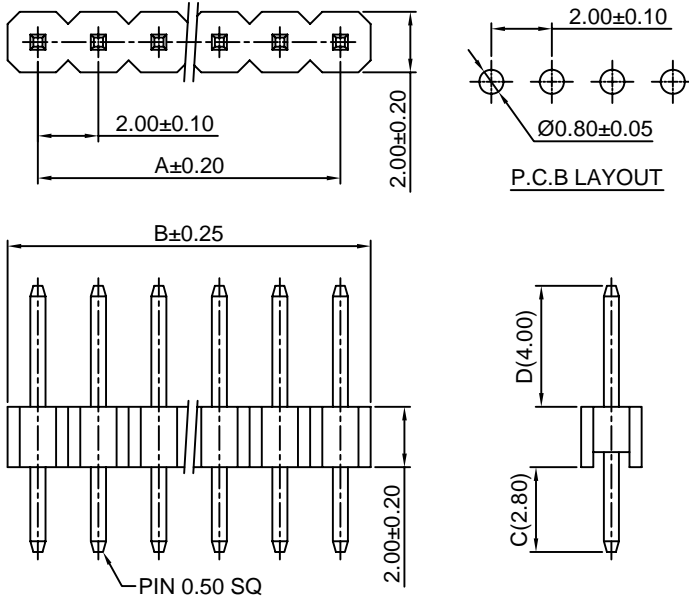

Ordering Information & Dimensions:

PART NO.	Dimensions		PART NO.	Dimensions	
	A	B		A	B
A2005WV-2P	2.00	4.00	A2005WV-22P	42.00	44.00
A2005WV-3P	4.00	6.00	A2005WV-23P	44.00	46.00
A2005WV-4P	6.00	8.00	A2005WV-24P	46.00	48.00
A2005WV-5P	8.00	10.00	A2005WV-25P	48.00	50.00
A2005WV-6P	10.00	12.00	A2005WV-26P	50.00	52.00
A2005WV-7P	12.00	14.00	A2005WV-27P	52.00	54.00
A2005WV-8P	14.00	16.00	A2005WV-28P	54.00	56.00
A2005WV-9P	16.00	18.00	A2005WV-29P	56.00	58.00
A2005WV-10P	18.00	20.00	A2005WV-30P	58.00	60.00
A2005WV-11P	20.00	22.00	A2005WV-31P	60.00	62.00
A2005WV-12P	22.00	24.00	A2005WV-32P	62.00	64.00
A2005WV-13P	24.00	26.00	A2005WV-33P	64.00	66.00
A2005WV-14P	26.00	28.00	A2005WV-34P	66.00	68.00
A2005WV-15P	28.00	30.00	A2005WV-35P	68.00	70.00
A2005WV-16P	30.00	32.00	A2005WV-36P	70.00	72.00
A2005WV-17P	32.00	34.00	A2005WV-37P	72.00	74.00
A2005WV-18P	34.00	36.00	A2005WV-38P	74.00	76.00
A2005WV-19P	36.00	38.00	A2005WV-39P	76.00	78.00
A2005WV-20P	38.00	40.00	A2005WV-40P	78.00	80.00
A2005WV-21P	40.00	42.00			

Unit: mm

A2005WVA

2.00mm pitch 180° Single Row Pin Header

Reference Informations:

- *Material: Pin: Brass/Gold over Nickel
Insulator: Nylon 6T, UL94V-0
- *Mates with CJT A2005 series Single Row Female Header
- *Optional Dim. available but MOQ requested
- *Color: Black

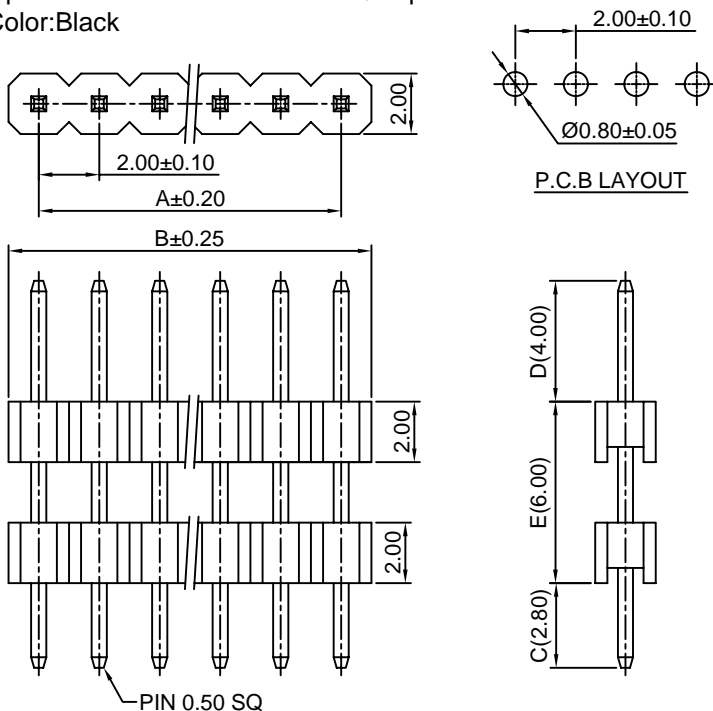

Ordering Information & Dimensions:

PART NO.	Dimensions		PART NO.	Dimensions	
	A	B		A	B
A2005WVA-2P	2.00	4.00	A2005WVA-22P	42.00	44.00
A2005WVA-3P	4.00	6.00	A2005WVA-23P	44.00	46.00
A2005WVA-4P	6.00	8.00	A2005WVA-24P	46.00	48.00
A2005WVA-5P	8.00	10.00	A2005WVA-25P	48.00	50.00
A2005WVA-6P	10.00	12.00	A2005WVA-26P	50.00	52.00
A2005WVA-7P	12.00	14.00	A2005WVA-27P	52.00	54.00
A2005WVA-8P	14.00	16.00	A2005WVA-28P	54.00	56.00
A2005WVA-9P	16.00	18.00	A2005WVA-29P	56.00	58.00
A2005WVA-10P	18.00	20.00	A2005WVA-30P	58.00	60.00
A2005WVA-11P	20.00	22.00	A2005WVA-31P	60.00	62.00
A2005WVA-12P	22.00	24.00	A2005WVA-32P	62.00	64.00
A2005WVA-13P	24.00	26.00	A2005WVA-33P	64.00	66.00
A2005WVA-14P	26.00	28.00	A2005WVA-34P	66.00	68.00
A2005WVA-15P	28.00	30.00	A2005WVA-35P	68.00	70.00
A2005WVA-16P	30.00	32.00	A2005WVA-36P	70.00	72.00
A2005WVA-17P	32.00	34.00	A2005WVA-37P	72.00	74.00
A2005WVA-18P	34.00	36.00	A2005WVA-38P	74.00	76.00
A2005WVA-19P	36.00	38.00	A2005WVA-39P	76.00	78.00
A2005WVA-20P	38.00	40.00	A2005WVA-40P	78.00	80.00
A2005WVA-21P	40.00	42.00			

Unit: mm

A2005WV-S-A

2.00mm Pitch 180° Single Row Pin Header-SMT TYPE

Reference Informations:

- *Material:Pin:Brass/Gold over Nickel
Insulator:Nylon 6T,UL94V-0
- *Mates with CJT A2005 series Single Row Female Header
- *Optional Dim. available but MOQ requested
- *Color:Black

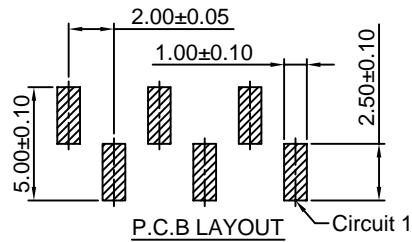
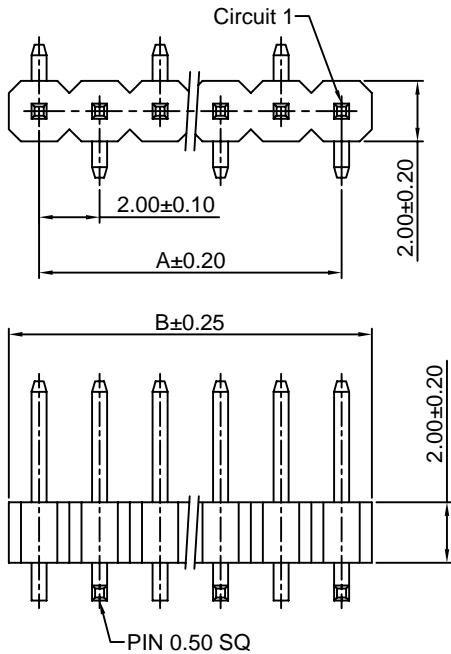

Ordering Information & Dimensions:

PART NO.	Dimensions		PART NO.	Dimensions	
	A	B		A	B
A2005WV-S-2P-A	2.00	4.00	A2005WV-S-22P-A	42.00	44.00
A2005WV-S-3P-A	4.00	6.00	A2005WV-S-23P-A	44.00	46.00
A2005WV-S-4P-A	6.00	8.00	A2005WV-S-24P-A	46.00	48.00
A2005WV-S-5P-A	8.00	10.00	A2005WV-S-25P-A	48.00	50.00
A2005WV-S-6P-A	10.00	12.00	A2005WV-S-26P-A	50.00	52.00
A2005WV-S-7P-A	12.00	14.00	A2005WV-S-27P-A	52.00	54.00
A2005WV-S-8P-A	14.00	16.00	A2005WV-S-28P-A	54.00	56.00
A2005WV-S-9P-A	16.00	18.00	A2005WV-S-29P-A	56.00	58.00
A2005WV-S-10P-A	18.00	20.00	A2005WV-S-30P-A	58.00	60.00
A2005WV-S-11P-A	20.00	22.00	A2005WV-S-31P-A	60.00	62.00
A2005WV-S-12P-A	22.00	24.00	A2005WV-S-32P-A	62.00	64.00
A2005WV-S-13P-A	24.00	26.00	A2005WV-S-33P-A	64.00	66.00
A2005WV-S-14P-A	26.00	28.00	A2005WV-S-34P-A	66.00	68.00
A2005WV-S-15P-A	28.00	30.00	A2005WV-S-35P-A	68.00	70.00
A2005WV-S-16P-A	30.00	32.00	A2005WV-S-36P-A	70.00	72.00
A2005WV-S-17P-A	32.00	34.00	A2005WV-S-37P-A	72.00	74.00
A2005WV-S-18P-A	34.00	36.00	A2005WV-S-38P-A	74.00	76.00
A2005WV-S-19P-A	36.00	38.00	A2005WV-S-39P-A	76.00	78.00
A2005WV-S-20P-A	38.00	40.00	A2005WV-S-40P-A	78.00	80.00
A2005WV-S-21P-A	40.00	42.00			

Unit: mm

A2005WV-S-B

2.00mm Pitch 180° Single Row Pin Header-SMT TYPE

Reference Informations:

- *Material:Pin:Brass/Gold over Nickel
Insulator:Nylon 6T,UL94V-0
- *Mates with CJT A2005 series Single Row Female Header
- *Optional Dim. available but MOQ requested
- *Color:Black

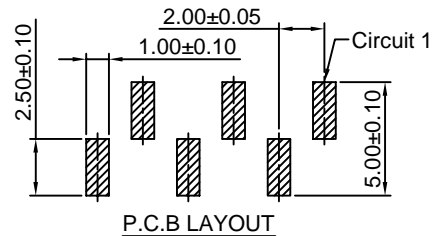
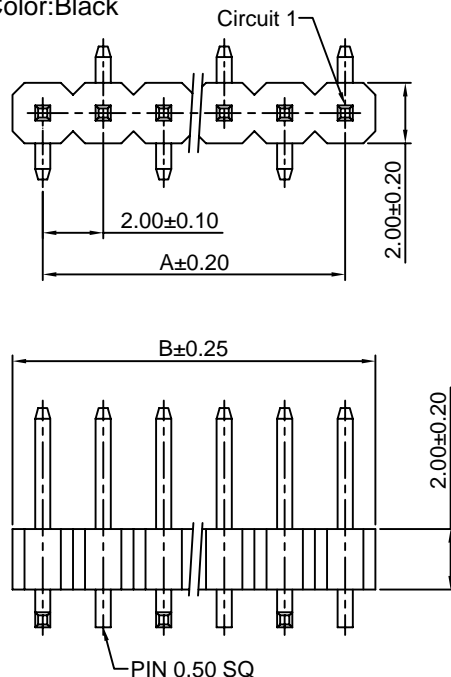

Ordering Information & Dimensions:

PART NO.	Dimensions		PART NO.	Dimensions	
	A	B		A	B
A2005WV-S-2P-B	2.00	4.00	A2005WV-S-22P-B	42.00	44.00
A2005WV-S-3P-B	4.00	6.00	A2005WV-S-23P-B	44.00	46.00
A2005WV-S-4P-B	6.00	8.00	A2005WV-S-24P-B	46.00	48.00
A2005WV-S-5P-B	8.00	10.00	A2005WV-S-25P-B	48.00	50.00
A2005WV-S-6P-B	10.00	12.00	A2005WV-S-26P-B	50.00	52.00
A2005WV-S-7P-B	12.00	14.00	A2005WV-S-27P-B	52.00	54.00
A2005WV-S-8P-B	14.00	16.00	A2005WV-S-28P-B	54.00	56.00
A2005WV-S-9P-B	16.00	18.00	A2005WV-S-29P-B	56.00	58.00
A2005WV-S-10P-B	18.00	20.00	A2005WV-S-30P-B	58.00	60.00
A2005WV-S-11P-B	20.00	22.00	A2005WV-S-31P-B	60.00	62.00
A2005WV-S-12P-B	22.00	24.00	A2005WV-S-32P-B	62.00	64.00
A2005WV-S-13P-B	24.00	26.00	A2005WV-S-33P-B	64.00	66.00
A2005WV-S-14P-B	26.00	28.00	A2005WV-S-34P-B	66.00	68.00
A2005WV-S-15P-B	28.00	30.00	A2005WV-S-35P-B	68.00	70.00
A2005WV-S-16P-B	30.00	32.00	A2005WV-S-36P-B	70.00	72.00
A2005WV-S-17P-B	32.00	34.00	A2005WV-S-37P-B	72.00	74.00
A2005WV-S-18P-B	34.00	36.00	A2005WV-S-38P-B	74.00	76.00
A2005WV-S-19P-B	36.00	38.00	A2005WV-S-39P-B	76.00	78.00
A2005WV-S-20P-B	38.00	40.00	A2005WV-S-40P-B	78.00	80.00
A2005WV-S-21P-B	40.00	42.00			

Unit: mm

A2005WVA-S-A

2.00mm Pitch 180° Single Row Pin Header-SMT A TYPE

Reference Informations:

- *Material: Pin: Brass/Gold over Nickel
Insulator: Nylon 6T, UL94V-0
- *Mates with CJT A2005 series Single Row Female Header
- *Optional Dim. available but MOQ requested
- *Color: Black

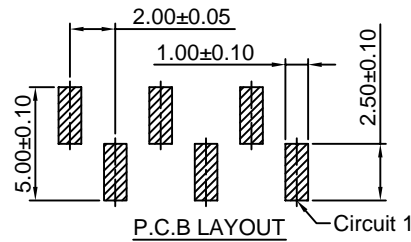
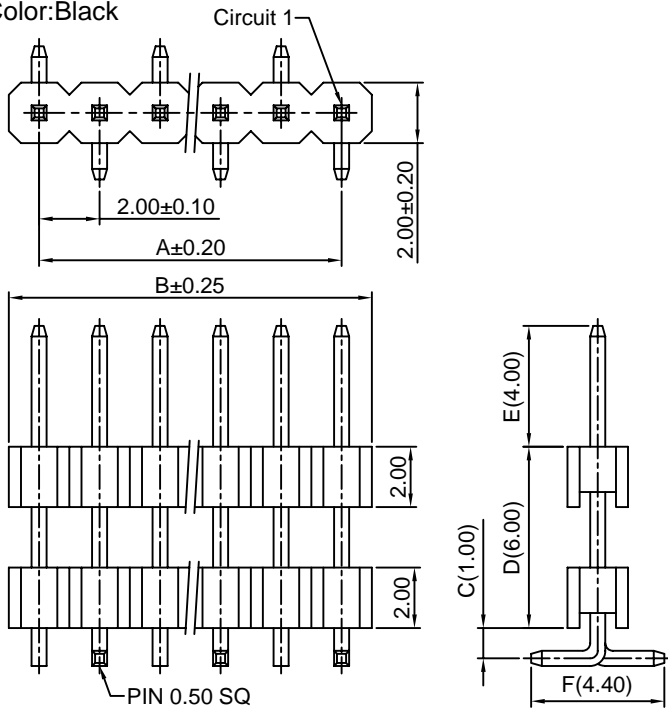

Ordering Information & Dimensions:

PART NO.	Dimensions		PART NO.	Dimensions	
	A	B		A	B
A2005WVA-S-2P-A	2.00	4.00	A2005WVA-S-22P-A	42.00	44.00
A2005WVA-S-3P-A	4.00	6.00	A2005WVA-S-23P-A	44.00	46.00
A2005WVA-S-4P-A	6.00	8.00	A2005WVA-S-24P-A	46.00	48.00
A2005WVA-S-5P-A	8.00	10.00	A2005WVA-S-25P-A	48.00	50.00
A2005WVA-S-6P-A	10.00	12.00	A2005WVA-S-26P-A	50.00	52.00
A2005WVA-S-7P-A	12.00	14.00	A2005WVA-S-27P-A	52.00	54.00
A2005WVA-S-8P-A	14.00	16.00	A2005WVA-S-28P-A	54.00	56.00
A2005WVA-S-9P-A	16.00	18.00	A2005WVA-S-29P-A	56.00	58.00
A2005WVA-S-10P-A	18.00	20.00	A2005WVA-S-30P-A	58.00	60.00
A2005WVA-S-11P-A	20.00	22.00	A2005WVA-S-31P-A	60.00	62.00
A2005WVA-S-12P-A	22.00	24.00	A2005WVA-S-32P-A	62.00	64.00
A2005WVA-S-13P-A	24.00	26.00	A2005WVA-S-33P-A	64.00	66.00
A2005WVA-S-14P-A	26.00	28.00	A2005WVA-S-34P-A	66.00	68.00
A2005WVA-S-15P-A	28.00	30.00	A2005WVA-S-35P-A	68.00	70.00
A2005WVA-S-16P-A	30.00	32.00	A2005WVA-S-36P-A	70.00	72.00
A2005WVA-S-17P-A	32.00	34.00	A2005WVA-S-37P-A	72.00	74.00
A2005WVA-S-18P-A	34.00	36.00	A2005WVA-S-38P-A	74.00	76.00
A2005WVA-S-19P-A	36.00	38.00	A2005WVA-S-39P-A	76.00	78.00
A2005WVA-S-20P-A	38.00	40.00	A2005WVA-S-40P-A	78.00	80.00
A2005WVA-S-21P-A	40.00	42.00			

Unit: mm

A2005WVA-S-B

2.00mm Pitch 180° Single Row Pin Header-SMT B TYPE

Reference Informations:

- *Material: Pin: Brass/Gold over Nickel
Insulator: Nylon 6T, UL94V-0
- *Mates with CJT A2005 series Single Row Female Header
- *Optional Dim. available but MOQ requested
- *Color: Black

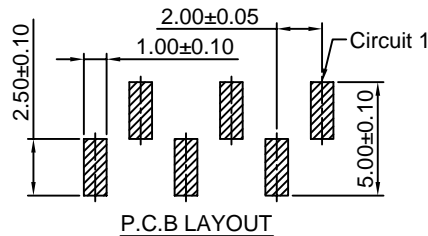
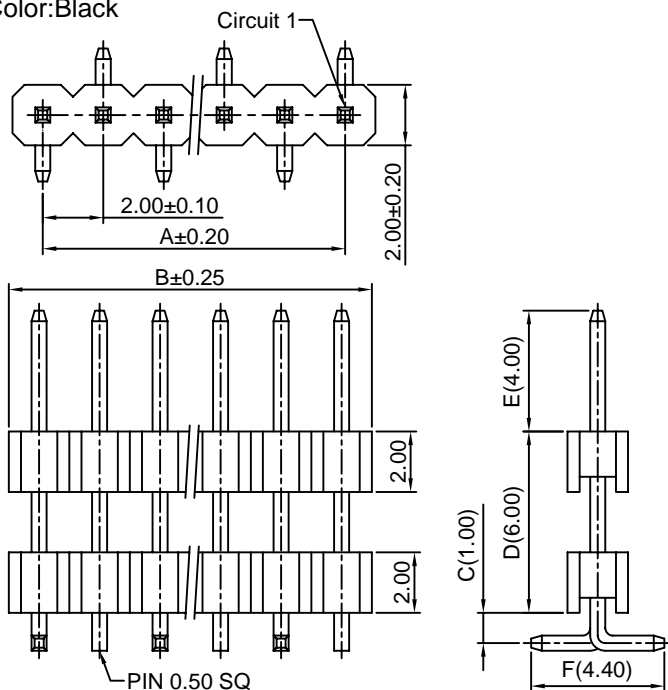

Ordering Information & Dimensions:

PART NO.	Dimensions		PART NO.	Dimensions	
	A	B		A	B
A2005WVA-S-2P-B	2.00	4.00	A2005WVA-S-22P-B	42.00	44.00
A2005WVA-S-3P-B	4.00	6.00	A2005WVA-S-23P-B	44.00	46.00
A2005WVA-S-4P-B	6.00	8.00	A2005WVA-S-24P-B	46.00	48.00
A2005WVA-S-5P-B	8.00	10.00	A2005WVA-S-25P-B	48.00	50.00
A2005WVA-S-6P-B	10.00	12.00	A2005WVA-S-26P-B	50.00	52.00
A2005WVA-S-7P-B	12.00	14.00	A2005WVA-S-27P-B	52.00	54.00
A2005WVA-S-8P-B	14.00	16.00	A2005WVA-S-28P-B	54.00	56.00
A2005WVA-S-9P-B	16.00	18.00	A2005WVA-S-29P-B	56.00	58.00
A2005WVA-S-10P-B	18.00	20.00	A2005WVA-S-30P-B	58.00	60.00
A2005WVA-S-11P-B	20.00	22.00	A2005WVA-S-31P-B	60.00	62.00
A2005WVA-S-12P-B	22.00	24.00	A2005WVA-S-32P-B	62.00	64.00
A2005WVA-S-13P-B	24.00	26.00	A2005WVA-S-33P-B	64.00	66.00
A2005WVA-S-14P-B	26.00	28.00	A2005WVA-S-34P-B	66.00	68.00
A2005WVA-S-15P-B	28.00	30.00	A2005WVA-S-35P-B	68.00	70.00
A2005WVA-S-16P-B	30.00	32.00	A2005WVA-S-36P-B	70.00	72.00
A2005WVA-S-17P-B	32.00	34.00	A2005WVA-S-37P-B	72.00	74.00
A2005WVA-S-18P-B	34.00	36.00	A2005WVA-S-38P-B	74.00	76.00
A2005WVA-S-19P-B	36.00	38.00	A2005WVA-S-39P-B	76.00	78.00
A2005WVA-S-20P-B	38.00	40.00	A2005WVA-S-40P-B	78.00	80.00
A2005WVA-S-21P-B	40.00	42.00			

Unit: mm

A2005WR

2.00mm pitch 90° Single Row Pin Header

Reference Informations:

- *Material: Pin: Brass/Gold over Nickel
Insulator: Nylon 6T, UL94V-0
- *Mates with CJT A2005 series Single Row Female Header
- *Optional Dim. available but MOQ requested
- *Color: Black

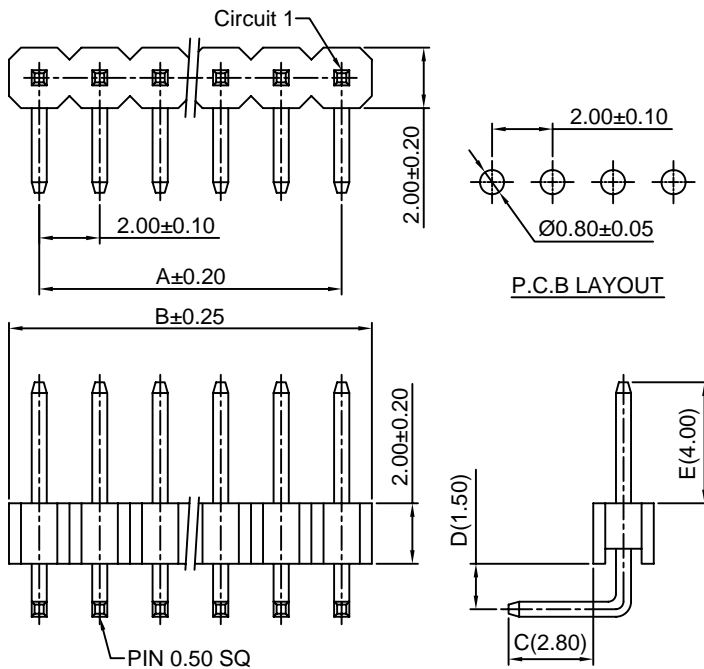

Ordering Information & Dimensions:

PART NO.	Dimensions		PART NO.	Dimensions	
	A	B		A	B
A2005WR-2P	2.00	4.00	A2005WR-22P	42.00	44.00
A2005WR-3P	4.00	6.00	A2005WR-23P	44.00	46.00
A2005WR-4P	6.00	8.00	A2005WR-24P	46.00	48.00
A2005WR-5P	8.00	10.00	A2005WR-25P	48.00	50.00
A2005WR-6P	10.00	12.00	A2005WR-26P	50.00	52.00
A2005WR-7P	12.00	14.00	A2005WR-27P	52.00	54.00
A2005WR-8P	14.00	16.00	A2005WR-28P	54.00	56.00
A2005WR-9P	16.00	18.00	A2005WR-29P	56.00	58.00
A2005WR-10P	18.00	20.00	A2005WR-30P	58.00	60.00
A2005WR-11P	20.00	22.00	A2005WR-31P	60.00	62.00
A2005WR-12P	22.00	24.00	A2005WR-32P	62.00	64.00
A2005WR-13P	24.00	26.00	A2005WR-33P	64.00	66.00
A2005WR-14P	26.00	28.00	A2005WR-34P	66.00	68.00
A2005WR-15P	28.00	30.00	A2005WR-35P	68.00	70.00
A2005WR-16P	30.00	32.00	A2005WR-36P	70.00	72.00
A2005WR-17P	32.00	34.00	A2005WR-37P	72.00	74.00
A2005WR-18P	34.00	36.00	A2005WR-38P	74.00	76.00
A2005WR-19P	36.00	38.00	A2005WR-39P	76.00	78.00
A2005WR-20P	38.00	40.00	A2005WR-40P	78.00	80.00
A2005WR-21P	40.00	42.00			

Unit: mm

A2005WRA

2.00mm pitch 90° Single Row Pin Header

Reference Informations:

- *Material: Pin: Brass/Gold over Nickel
Insulator: Nylon 6T, UL94V-0
- *Mates with CJT A2005 series Single Row Female Header
- *Optional Dim. available but MOQ requested
- *Color: Black

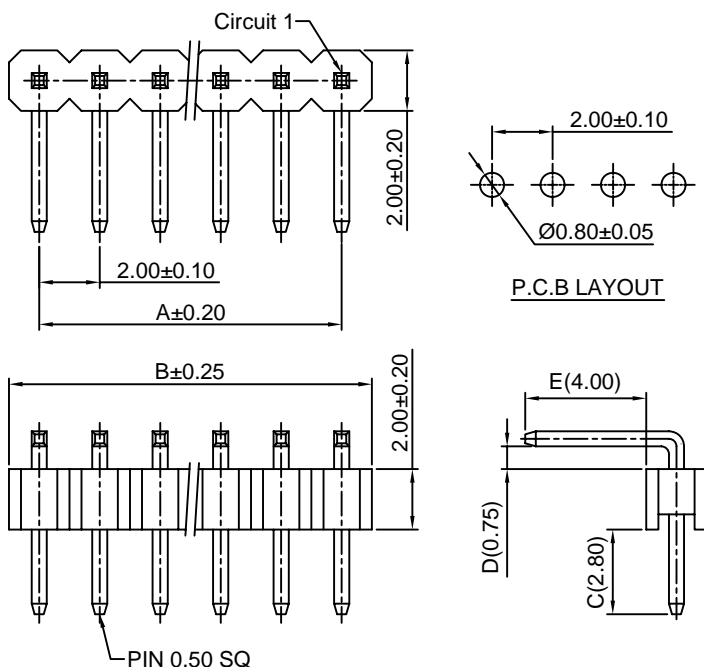

Ordering Information & Dimensions:

PART NO.	Dimensions		PART NO.	Dimensions	
	A	B		A	B
A2005WRA-2P	2.00	4.00	A2005WRA-22P	42.00	44.00
A2005WRA-3P	4.00	6.00	A2005WRA-23P	44.00	46.00
A2005WRA-4P	6.00	8.00	A2005WRA-24P	46.00	48.00
A2005WRA-5P	8.00	10.00	A2005WRA-25P	48.00	50.00
A2005WRA-6P	10.00	12.00	A2005WRA-26P	50.00	52.00
A2005WRA-7P	12.00	14.00	A2005WRA-27P	52.00	54.00
A2005WRA-8P	14.00	16.00	A2005WRA-28P	54.00	56.00
A2005WRA-9P	16.00	18.00	A2005WRA-29P	56.00	58.00
A2005WRA-10P	18.00	20.00	A2005WRA-30P	58.00	60.00
A2005WRA-11P	20.00	22.00	A2005WRA-31P	60.00	62.00
A2005WRA-12P	22.00	24.00	A2005WRA-32P	62.00	64.00
A2005WRA-13P	24.00	26.00	A2005WRA-33P	64.00	66.00
A2005WRA-14P	26.00	28.00	A2005WRA-34P	66.00	68.00
A2005WRA-15P	28.00	30.00	A2005WRA-35P	68.00	70.00
A2005WRA-16P	30.00	32.00	A2005WRA-36P	70.00	72.00
A2005WRA-17P	32.00	34.00	A2005WRA-37P	72.00	74.00
A2005WRA-18P	34.00	36.00	A2005WRA-38P	74.00	76.00
A2005WRA-19P	36.00	38.00	A2005WRA-39P	76.00	78.00
A2005WRA-20P	38.00	40.00	A2005WRA-40P	78.00	80.00
A2005WRA-21P	40.00	42.00			

Unit: mm

A2005WR-S

2.00mm Pitch 90° Single Row Pin Header-SMT TYPE

Reference Informations:

- *Material: Pin: Brass/Gold over Nickel
Insulator: Nylon 6T, UL94V-0
- *Mates with CJT A2005 series Single Row Female Header
- *Optional Dim. available but MOQ requested
- *Color: Black

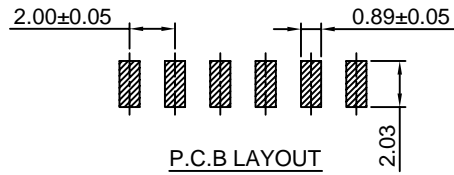
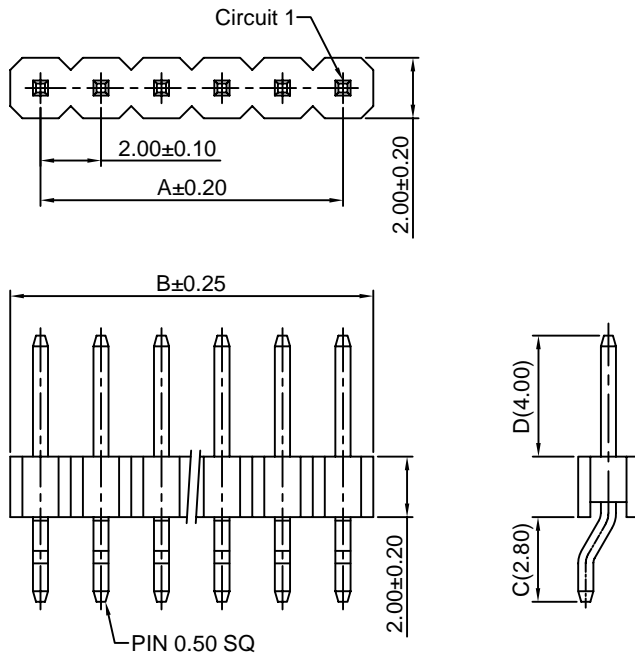

Ordering Information & Dimensions:

PART NO.	Dimensions		PART NO.	Dimensions	
	A	B		A	B
A2005WR-S-2P	2.00	4.00	A2005WR-S-22P	42.00	44.00
A2005WR-S-3P	4.00	6.00	A2005WR-S-23P	44.00	46.00
A2005WR-S-4P	6.00	8.00	A2005WR-S-24P	46.00	48.00
A2005WR-S-5P	8.00	10.00	A2005WR-S-25P	48.00	50.00
A2005WR-S-6P	10.00	12.00	A2005WR-S-26P	50.00	52.00
A2005WR-S-7P	12.00	14.00	A2005WR-S-27P	52.00	54.00
A2005WR-S-8P	14.00	16.00	A2005WR-S-28P	54.00	56.00
A2005WR-S-9P	16.00	18.00	A2005WR-S-29P	56.00	58.00
A2005WR-S-10P	18.00	20.00	A2005WR-S-30P	58.00	60.00
A2005WR-S-11P	20.00	22.00	A2005WR-S-31P	60.00	62.00
A2005WR-S-12P	22.00	24.00	A2005WR-S-32P	62.00	64.00
A2005WR-S-13P	24.00	26.00	A2005WR-S-33P	64.00	66.00
A2005WR-S-14P	26.00	28.00	A2005WR-S-34P	66.00	68.00
A2005WR-S-15P	28.00	30.00	A2005WR-S-35P	68.00	70.00
A2005WR-S-16P	30.00	32.00	A2005WR-S-36P	70.00	72.00
A2005WR-S-17P	32.00	34.00	A2005WR-S-37P	72.00	74.00
A2005WR-S-18P	34.00	36.00	A2005WR-S-38P	74.00	76.00
A2005WR-S-19P	36.00	38.00	A2005WR-S-39P	76.00	78.00
A2005WR-S-20P	38.00	40.00	A2005WR-S-40P	78.00	80.00
A2005WR-S-21P	40.00	42.00			

Unit: mm

A2005WV-2

2.00mm pitch 180° Dual Row Pin Header

Reference Informations:

- *Material: Pin: Brass/Gold over Nickel
Insulator: Nylon 6T, UL94V-0
- *Mates with CJT A2005 series Dual Row Female Header
- *Optional Dim. available but MOQ requested
- *Color: Black

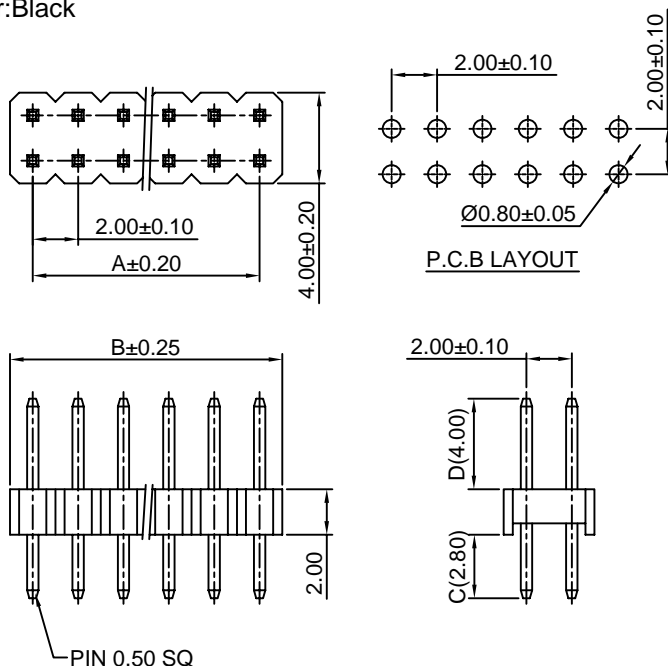

Ordering Information & Dimensions:

PART NO.	Dimensions		PART NO.	Dimensions	
	A	B		A	B
A2005WV-2x2P	2.00	4.00	A2005WV-2x22P	42.00	44.00
A2005WV-2x3P	4.00	6.00	A2005WV-2x23P	44.00	46.00
A2005WV-2x4P	6.00	8.00	A2005WV-2x24P	46.00	48.00
A2005WV-2x5P	8.00	10.00	A2005WV-2x25P	48.00	50.00
A2005WV-2x6P	10.00	12.00	A2005WV-2x26P	50.00	52.00
A2005WV-2x7P	12.00	14.00	A2005WV-2x27P	52.00	54.00
A2005WV-2x8P	14.00	16.00	A2005WV-2x28P	54.00	56.00
A2005WV-2x9P	16.00	18.00	A2005WV-2x29P	56.00	58.00
A2005WV-2x10P	18.00	20.00	A2005WV-2x30P	58.00	60.00
A2005WV-2x11P	20.00	22.00	A2005WV-2x31P	60.00	62.00
A2005WV-2x12P	22.00	24.00	A2005WV-2x32P	62.00	64.00
A2005WV-2x13P	24.00	26.00	A2005WV-2x33P	64.00	66.00
A2005WV-2x14P	26.00	28.00	A2005WV-2x34P	66.00	68.00
A2005WV-2x15P	28.00	30.00	A2005WV-2x35P	68.00	70.00
A2005WV-2x16P	30.00	32.00	A2005WV-2x36P	70.00	72.00
A2005WV-2x17P	32.00	34.00	A2005WV-2x37P	72.00	74.00
A2005WV-2x18P	34.00	36.00	A2005WV-2x38P	74.00	76.00
A2005WV-2x19P	36.00	38.00	A2005WV-2x39P	76.00	78.00
A2005WV-2x20P	38.00	40.00	A2005WV-2x40P	78.00	80.00
A2005WV-2x21P	40.00	42.00			

Unit: mm

A2005WV-S-2

2.00mm pitch 180° Dual Row Pin Header-SMT TYPE

Reference Informations:

- *Material:Pin:Brass/Gold over Nickel
Insulator:Nylon 6T,UL94V-0
- *Mates with CJT A2005 series Dual Row Female Header
- *Optional Dim. available but MOQ requested
- *Color:Black

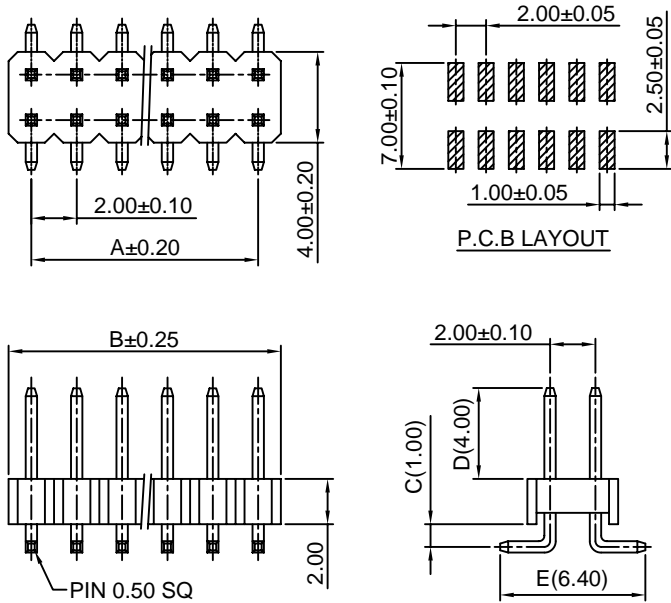

Ordering Information & Dimensions:

PART NO.	Dimensions		PART NO.	Dimensions	
	A	B		A	B
A2005WV-S-2x2P	2.00	4.00	A2005WV-S-2x22P	42.00	44.00
A2005WV-S-2x3P	4.00	6.00	A2005WV-S-2x23P	44.00	46.00
A2005WV-S-2x4P	6.00	8.00	A2005WV-S-2x24P	46.00	48.00
A2005WV-S-2x5P	8.00	10.00	A2005WV-S-2x25P	48.00	50.00
A2005WV-S-2x6P	10.00	12.00	A2005WV-S-2x26P	50.00	52.00
A2005WV-S-2x7P	12.00	14.00	A2005WV-S-2x27P	52.00	54.00
A2005WV-S-2x8P	14.00	16.00	A2005WV-S-2x28P	54.00	56.00
A2005WV-S-2x9P	16.00	18.00	A2005WV-S-2x29P	56.00	58.00
A2005WV-S-2x10P	18.00	20.00	A2005WV-S-2x30P	58.00	60.00
A2005WV-S-2x11P	20.00	22.00	A2005WV-S-2x31P	60.00	62.00
A2005WV-S-2x12P	22.00	24.00	A2005WV-S-2x32P	62.00	64.00
A2005WV-S-2x13P	24.00	26.00	A2005WV-S-2x33P	64.00	66.00
A2005WV-S-2x14P	26.00	28.00	A2005WV-S-2x34P	66.00	68.00
A2005WV-S-2x15P	28.00	30.00	A2005WV-S-2x35P	68.00	70.00
A2005WV-S-2x16P	30.00	32.00	A2005WV-S-2x36P	70.00	72.00
A2005WV-S-2x17P	32.00	34.00	A2005WV-S-2x37P	72.00	74.00
A2005WV-S-2x18P	34.00	36.00	A2005WV-S-2x38P	74.00	76.00
A2005WV-S-2x19P	36.00	38.00	A2005WV-S-2x39P	76.00	78.00
A2005WV-S-2x20P	38.00	40.00	A2005WV-S-2x40P	78.00	80.00
A2005WV-S-2x21P	40.00	42.00			

Unit: mm

A2005WVA-2

2.00mm pitch 180° Dual Row Pin Header

Reference Informations:

- *Material:Pin:Brass/Gold over Nickel
Insulator:Nylon 6T,UL94V-0
- *Mates with CJT A2005 series Dual Row Female Header
- *Optional Dim. available but MOQ requested
- *Color:Black

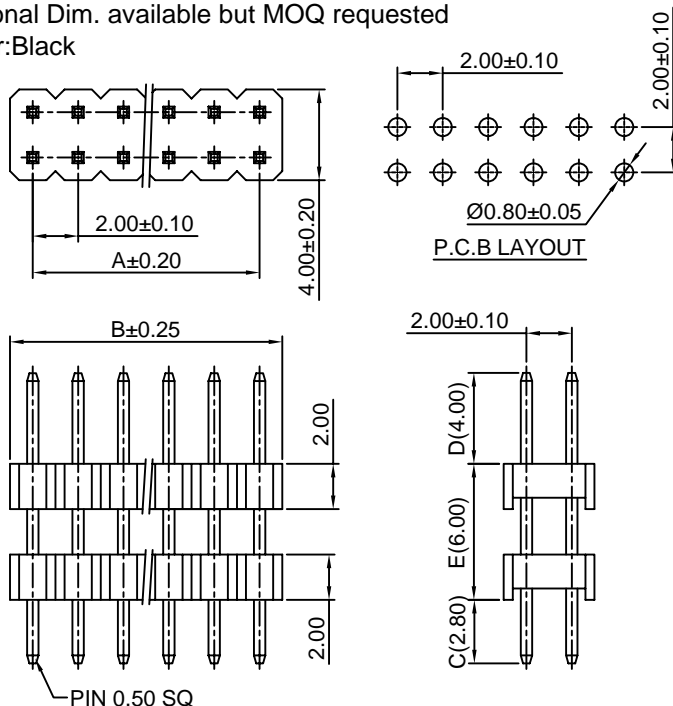

Ordering Information & Dimensions:

PART NO.	Dimensions		PART NO.	Dimensions	
	A	B		A	B
A2005WVA-2x2P	2.00	4.00	A2005WVA-2x22P	42.00	44.00
A2005WVA-2x3P	4.00	6.00	A2005WVA-2x23P	44.00	46.00
A2005WVA-2x4P	6.00	8.00	A2005WVA-2x24P	46.00	48.00
A2005WVA-2x5P	8.00	10.00	A2005WVA-2x25P	48.00	50.00
A2005WVA-2x6P	10.00	12.00	A2005WVA-2x26P	50.00	52.00
A2005WVA-2x7P	12.00	14.00	A2005WVA-2x27P	52.00	54.00
A2005WVA-2x8P	14.00	16.00	A2005WVA-2x28P	54.00	56.00
A2005WVA-2x9P	16.00	18.00	A2005WVA-2x29P	56.00	58.00
A2005WVA-2x10P	18.00	20.00	A2005WVA-2x30P	58.00	60.00
A2005WVA-2x11P	20.00	22.00	A2005WVA-2x31P	60.00	62.00
A2005WVA-2x12P	22.00	24.00	A2005WVA-2x32P	62.00	64.00
A2005WVA-2x13P	24.00	26.00	A2005WVA-2x33P	64.00	66.00
A2005WVA-2x14P	26.00	28.00	A2005WVA-2x34P	66.00	68.00
A2005WVA-2x15P	28.00	30.00	A2005WVA-2x35P	68.00	70.00
A2005WVA-2x16P	30.00	32.00	A2005WVA-2x36P	70.00	72.00
A2005WVA-2x17P	32.00	34.00	A2005WVA-2x37P	72.00	74.00
A2005WVA-2x18P	34.00	36.00	A2005WVA-2x38P	74.00	76.00
A2005WVA-2x19P	36.00	38.00	A2005WVA-2x39P	76.00	78.00
A2005WVA-2x20P	38.00	40.00	A2005WVA-2x40P	78.00	80.00
A2005WVA-2x21P	40.00	42.00			

Unit: mm

A2005WVA-S-2

2.00mm pitch 180° Dual Row Pin Header - SMT TYPE

Reference Informations:

- *Material: Pin: Brass/Gold over Nickel
Insulator: Nylon 6T, UL94V-0
- *Mates with CJT A2005 series Dual Row Female Header
- *Optional Dim. available but MOQ requested
- *Color: Black

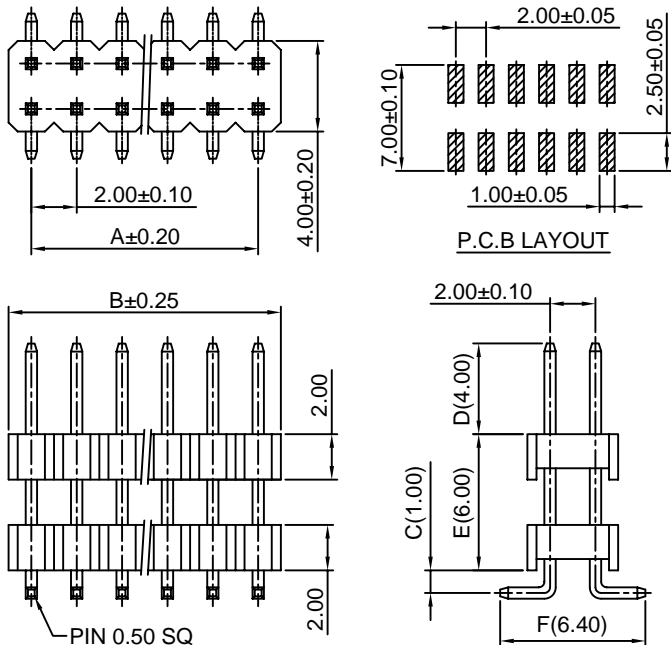

Ordering Information & Dimensions:

PART NO.	Dimensions		PART NO.	Dimensions	
	A	B		A	B
A2005WVA-S-2x2P	2.00	4.00	A2005WVA-S-2x22P	42.00	44.00
A2005WVA-S-2x3P	4.00	6.00	A2005WVA-S-2x23P	44.00	46.00
A2005WVA-S-2x4P	6.00	8.00	A2005WVA-S-2x24P	46.00	48.00
A2005WVA-S-2x5P	8.00	10.00	A2005WVA-S-2x25P	48.00	50.00
A2005WVA-S-2x6P	10.00	12.00	A2005WVA-S-2x26P	50.00	52.00
A2005WVA-S-2x7P	12.00	14.00	A2005WVA-S-2x27P	52.00	54.00
A2005WVA-S-2x8P	14.00	16.00	A2005WVA-S-2x28P	54.00	56.00
A2005WVA-S-2x9P	16.00	18.00	A2005WVA-S-2x29P	56.00	58.00
A2005WVA-S-2x10P	18.00	20.00	A2005WVA-S-2x30P	58.00	60.00
A2005WVA-S-2x11P	20.00	22.00	A2005WVA-S-2x31P	60.00	62.00
A2005WVA-S-2x12P	22.00	24.00	A2005WVA-S-2x32P	62.00	64.00
A2005WVA-S-2x13P	24.00	26.00	A2005WVA-S-2x33P	64.00	66.00
A2005WVA-S-2x14P	26.00	28.00	A2005WVA-S-2x34P	66.00	68.00
A2005WVA-S-2x15P	28.00	30.00	A2005WVA-S-2x35P	68.00	70.00
A2005WVA-S-2x16P	30.00	32.00	A2005WVA-S-2x36P	70.00	72.00
A2005WVA-S-2x17P	32.00	34.00	A2005WVA-S-2x37P	72.00	74.00
A2005WVA-S-2x18P	34.00	36.00	A2005WVA-S-2x38P	74.00	76.00
A2005WVA-S-2x19P	36.00	38.00	A2005WVA-S-2x39P	76.00	78.00
A2005WVA-S-2x20P	38.00	40.00	A2005WVA-S-2x40P	78.00	80.00
A2005WVA-S-2x21P	40.00	42.00			

Unit: mm

A2005WVA-S-F-2

2.00mm pitch 180° Dual Row Pin Header - SMT TYPE

Reference Informations:

- *Material: Pin: Brass/Gold over Nickel
Insulator: Nylon 6T, UL94V-0
- *Mates with CJT A2005 series Dual Row Female Header
- *Optional Dim. available but MOQ requested
- *Color: Black

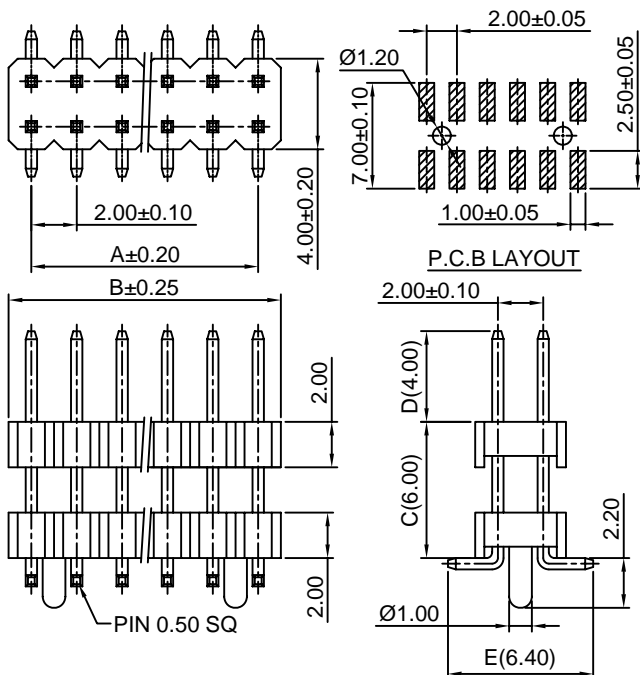

Ordering Information & Dimensions:

PART NO.	Dimensions		PART NO.	Dimensions	
	A	B		A	B
A2005WVA-S-F-2x2P	2.00	4.00	A2005WVA-S-F-2x22P	42.00	44.00
A2005WVA-S-F-2x3P	4.00	6.00	A2005WVA-S-F-2x23P	44.00	46.00
A2005WVA-S-F-2x4P	6.00	8.00	A2005WVA-S-F-2x24P	46.00	48.00
A2005WVA-S-F-2x5P	8.00	10.00	A2005WVA-S-F-2x25P	48.00	50.00
A2005WVA-S-F-2x6P	10.00	12.00	A2005WVA-S-F-2x26P	50.00	52.00
A2005WVA-S-F-2x7P	12.00	14.00	A2005WVA-S-F-2x27P	52.00	54.00
A2005WVA-S-F-2x8P	14.00	16.00	A2005WVA-S-F-2x28P	54.00	56.00
A2005WVA-S-F-2x9P	16.00	18.00	A2005WVA-S-F-2x29P	56.00	58.00
A2005WVA-S-F-2x10P	18.00	20.00	A2005WVA-S-F-2x30P	58.00	60.00
A2005WVA-S-F-2x11P	20.00	22.00	A2005WVA-S-F-2x31P	60.00	62.00
A2005WVA-S-F-2x12P	22.00	24.00	A2005WVA-S-F-2x32P	62.00	64.00
A2005WVA-S-F-2x13P	24.00	26.00	A2005WVA-S-F-2x33P	64.00	66.00
A2005WVA-S-F-2x14P	26.00	28.00	A2005WVA-S-F-2x34P	66.00	68.00
A2005WVA-S-F-2x15P	28.00	30.00	A2005WVA-S-F-2x35P	68.00	70.00
A2005WVA-S-F-2x16P	30.00	32.00	A2005WVA-S-F-2x36P	70.00	72.00
A2005WVA-S-F-2x17P	32.00	34.00	A2005WVA-S-F-2x37P	72.00	74.00
A2005WVA-S-F-2x18P	34.00	36.00	A2005WVA-S-F-2x38P	74.00	76.00
A2005WVA-S-F-2x19P	36.00	38.00	A2005WVA-S-F-2x39P	76.00	78.00
A2005WVA-S-F-2x20P	38.00	40.00	A2005WVA-S-F-2x40P	78.00	80.00
A2005WVA-S-F-2x21P	40.00	42.00			

Unit: mm

A2005WR-2

2.00mm pitch 90° Dual Row Pin Header

Reference Informations:

- *Material: Pin: Brass/Gold over Nickel
Insulator: Nylon 6T, UL94V-0
- *Mates with CJT A2005 series Dual Row Female Header
- *Optional Dim. available but MOQ requested
- *Color: Black

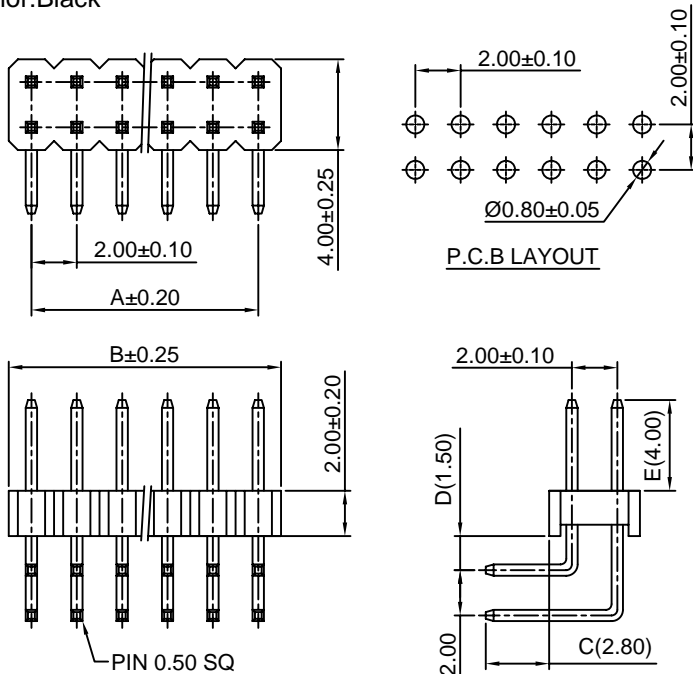

Ordering Information & Dimensions:

PART NO.	Dimensions		PART NO.	Dimensions	
	A	B		A	B
A2005WR-2x2P	2.00	4.00	A2005WR-2x22P	42.00	44.00
A2005WR-2x3P	4.00	6.00	A2005WR-2x23P	44.00	46.00
A2005WR-2x4P	6.00	8.00	A2005WR-2x24P	46.00	48.00
A2005WR-2x5P	8.00	10.00	A2005WR-2x25P	48.00	50.00
A2005WR-2x6P	10.00	12.00	A2005WR-2x26P	50.00	52.00
A2005WR-2x7P	12.00	14.00	A2005WR-2x27P	52.00	54.00
A2005WR-2x8P	14.00	16.00	A2005WR-2x28P	54.00	56.00
A2005WR-2x9P	16.00	18.00	A2005WR-2x29P	56.00	58.00
A2005WR-2x10P	18.00	20.00	A2005WR-2x30P	58.00	60.00
A2005WR-2x11P	20.00	22.00	A2005WR-2x31P	60.00	62.00
A2005WR-2x12P	22.00	24.00	A2005WR-2x32P	62.00	64.00
A2005WR-2x13P	24.00	26.00	A2005WR-2x33P	64.00	66.00
A2005WR-2x14P	26.00	28.00	A2005WR-2x34P	66.00	68.00
A2005WR-2x15P	28.00	30.00	A2005WR-2x35P	68.00	70.00
A2005WR-2x16P	30.00	32.00	A2005WR-2x36P	70.00	72.00
A2005WR-2x17P	32.00	34.00	A2005WR-2x37P	72.00	74.00
A2005WR-2x18P	34.00	36.00	A2005WR-2x38P	74.00	76.00
A2005WR-2x19P	36.00	38.00	A2005WR-2x39P	76.00	78.00
A2005WR-2x20P	38.00	40.00	A2005WR-2x40P	78.00	80.00
A2005WR-2x21P	40.00	42.00			

Unit: mm

A2005WR-S-2

2.00mm pitch 90° Dual Row Pin Header-SMT TYPE

Reference Informations:

- *Material: Pin: Brass/Gold over Nickel
Insulator: Nylon 6T, UL94V-0
- *Mates with CJT A2005 series Dual Row Female Header
- *Optional Dim. available but MOQ requested
- *Color: Black

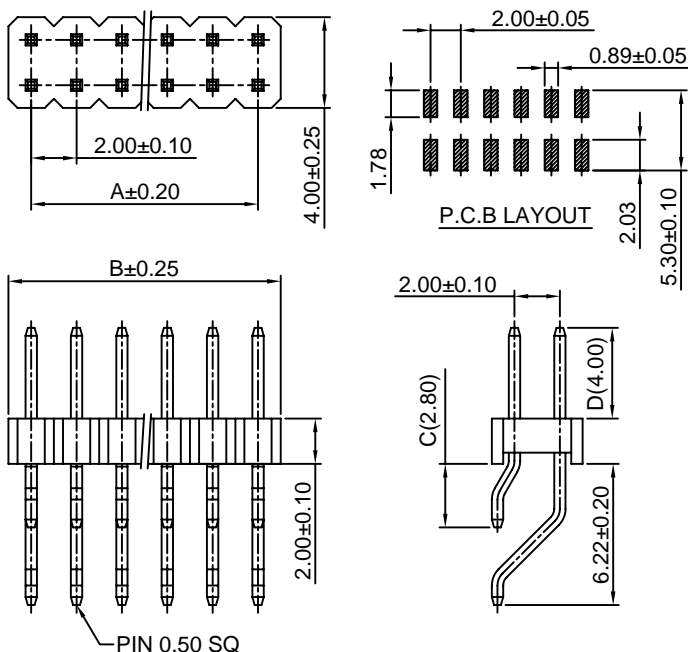
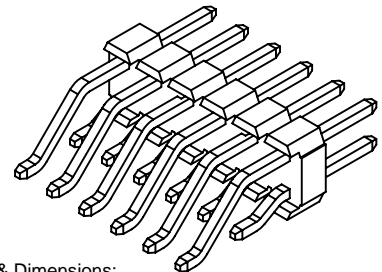

Ordering Information & Dimensions:

PART NO.	Dimensions		PART NO.	Dimensions	
	A	B		A	B
A2005WR-S-2x2P	2.00	4.00	A2005WR-S-2x22P	42.00	44.00
A2005WR-S-2x3P	4.00	6.00	A2005WR-S-2x23P	44.00	46.00
A2005WR-S-2x4P	6.00	8.00	A2005WR-S-2x24P	46.00	48.00
A2005WR-S-2x5P	8.00	10.00	A2005WR-S-2x25P	48.00	50.00
A2005WR-S-2x6P	10.00	12.00	A2005WR-S-2x26P	50.00	52.00
A2005WR-S-2x7P	12.00	14.00	A2005WR-S-2x27P	52.00	54.00
A2005WR-S-2x8P	14.00	16.00	A2005WR-S-2x28P	54.00	56.00
A2005WR-S-2x9P	16.00	18.00	A2005WR-S-2x29P	56.00	58.00
A2005WR-S-2x10P	18.00	20.00	A2005WR-S-2x30P	58.00	60.00
A2005WR-S-2x11P	20.00	22.00	A2005WR-S-2x31P	60.00	62.00
A2005WR-S-2x12P	22.00	24.00	A2005WR-S-2x32P	62.00	64.00
A2005WR-S-2x13P	24.00	26.00	A2005WR-S-2x33P	64.00	66.00
A2005WR-S-2x14P	26.00	28.00	A2005WR-S-2x34P	66.00	68.00
A2005WR-S-2x15P	28.00	30.00	A2005WR-S-2x35P	68.00	70.00
A2005WR-S-2x16P	30.00	32.00	A2005WR-S-2x36P	70.00	72.00
A2005WR-S-2x17P	32.00	34.00	A2005WR-S-2x37P	72.00	74.00
A2005WR-S-2x18P	34.00	36.00	A2005WR-S-2x38P	74.00	76.00
A2005WR-S-2x19P	36.00	38.00	A2005WR-S-2x39P	76.00	78.00
A2005WR-S-2x20P	38.00	40.00	A2005WR-S-2x40P	78.00	80.00
A2005WR-S-2x21P	40.00	42.00			

Unit: mm

A2005WRB-2

2.00mm pitch 90° Dual Row Pin Header

Reference Informations:

- *Material: Pin: Brass/Gold over Nickel
Insulator: Nylon 6T, UL94V-0
- *Mates with CJT A2005 series Dual Row Female Header
- *Optional Dim. available but MOQ requested
- *Color: Black

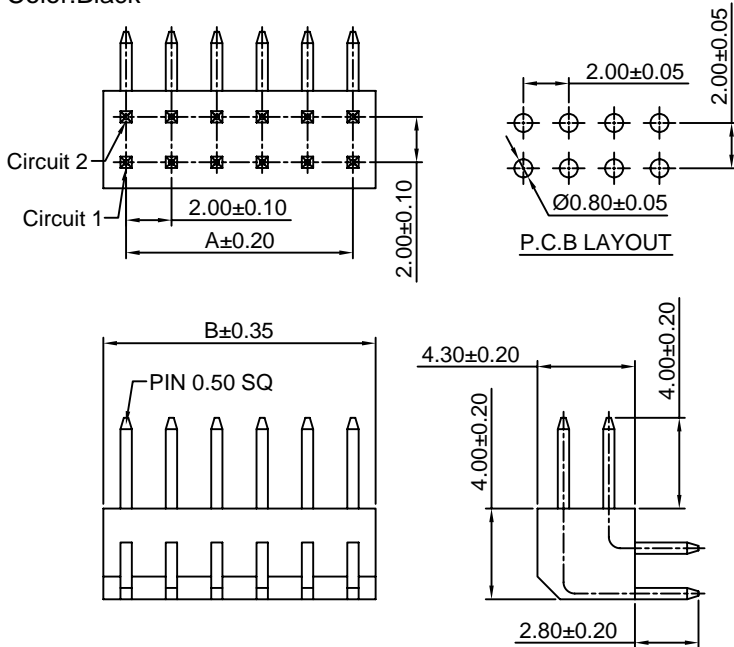

Ordering Information & Dimensions:

PART NO.	Dimensions		PART NO.	Dimensions	
	A	B		A	B
A2005WRB-2x2P	2.00	4.00	A2005WRB-2x22P	42.00	44.00
A2005WRB-2x3P	4.00	6.00	A2005WRB-2x23P	44.00	46.00
A2005WRB-2x4P	6.00	8.00	A2005WRB-2x24P	46.00	48.00
A2005WRB-2x5P	8.00	10.00	A2005WRB-2x25P	48.00	50.00
A2005WRB-2x6P	10.00	12.00	A2005WRB-2x26P	50.00	52.00
A2005WRB-2x7P	12.00	14.00	A2005WRB-2x27P	52.00	54.00
A2005WRB-2x8P	14.00	16.00	A2005WRB-2x28P	54.00	56.00
A2005WRB-2x9P	16.00	18.00	A2005WRB-2x29P	56.00	58.00
A2005WRB-2x10P	18.00	20.00	A2005WRB-2x30P	58.00	60.00
A2005WRB-2x11P	20.00	22.00	A2005WRB-2x31P	60.00	62.00
A2005WRB-2x12P	22.00	24.00	A2005WRB-2x32P	62.00	64.00
A2005WRB-2x13P	24.00	26.00	A2005WRB-2x33P	64.00	66.00
A2005WRB-2x14P	26.00	28.00	A2005WRB-2x34P	66.00	68.00
A2005WRB-2x15P	28.00	30.00	A2005WRB-2x35P	68.00	70.00
A2005WRB-2x16P	30.00	32.00	A2005WRB-2x36P	70.00	72.00
A2005WRB-2x17P	32.00	34.00	A2005WRB-2x37P	72.00	74.00
A2005WRB-2x18P	34.00	36.00	A2005WRB-2x38P	74.00	76.00
A2005WRB-2x19P	36.00	38.00	A2005WRB-2x39P	76.00	78.00
A2005WRB-2x20P	38.00	40.00	A2005WRB-2x40P	78.00	80.00
A2005WRB-2x21P	40.00	42.00			

Unit: mm

X-ON Electronics

Largest Supplier of Electrical and Electronic Components

Click to view similar products for [Headers & Wire Housings](#) category:

Click to view products by [Changjiang](#) manufacturer:

Other Similar products are found below :

[57102-F02-18ULF](#) [58102-G61-06LF](#) [582553-1](#) [009176003701906](#) [0050291907](#) [02.125.8002.8](#) [609-3404](#) [61062-3](#) [622-0430](#) [622-3653LF](#)
[63453-116](#) [636-1030](#) [636-1427](#) [636-3427](#) [636-4007](#) [641938-9](#) [65495-038](#) [65692-001LF](#) [65781-018](#) [65781-047](#) [65817-010LF](#) [65817-015LF](#)
[66207-023LF](#) [67016-026LF](#) [67095-007LF](#) [68631-112](#) [68645-018](#) [68648-049](#) [699319-000](#) [M90C108951C](#) [70.362.1628.0](#) [70-4210](#) [70-4226B](#)
[70-4853B](#) [707-5020](#) [707-5028](#) [71.350.2428.0](#) [71961-016LF](#) [733-134](#) [754199-000](#) [760-3052](#) [787-8014-00](#) [FCN-367T-T012/H](#)
[80.063.4001.1](#) [800-90-001-10-001000](#) [801-43-002-10-013000](#) [801-43-006-10-002000](#) [803-41-018-10-001000](#) [803-43-014-20-001000](#)
[803-43-024-10-001000](#)