

Specifications

- Current rating:4A AC,DC
- Voltage rating:125V AC,DC
- Temperature range:-40°C~+105°C
- Contact resistance:10mΩMax.
- Insulation resistance:1000MΩMin.
- Withstanding voltage:1000V AC/minute
- *Compliant with RoHS and REACH*
- *Meet the HF/Halogen Free,need to customize*
- *Contact CJT for details*

Standards



Assembly layout

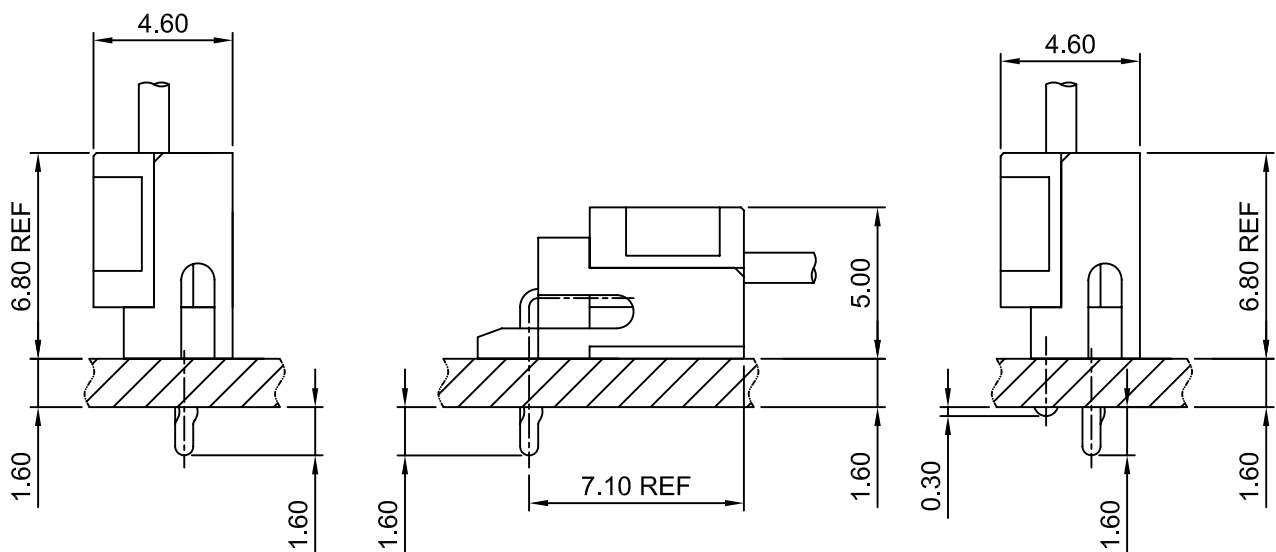

A2007-T

2.00mm pitch Crimp Terminal

Reference Informations:

*Used in CJT A2007 series Housing

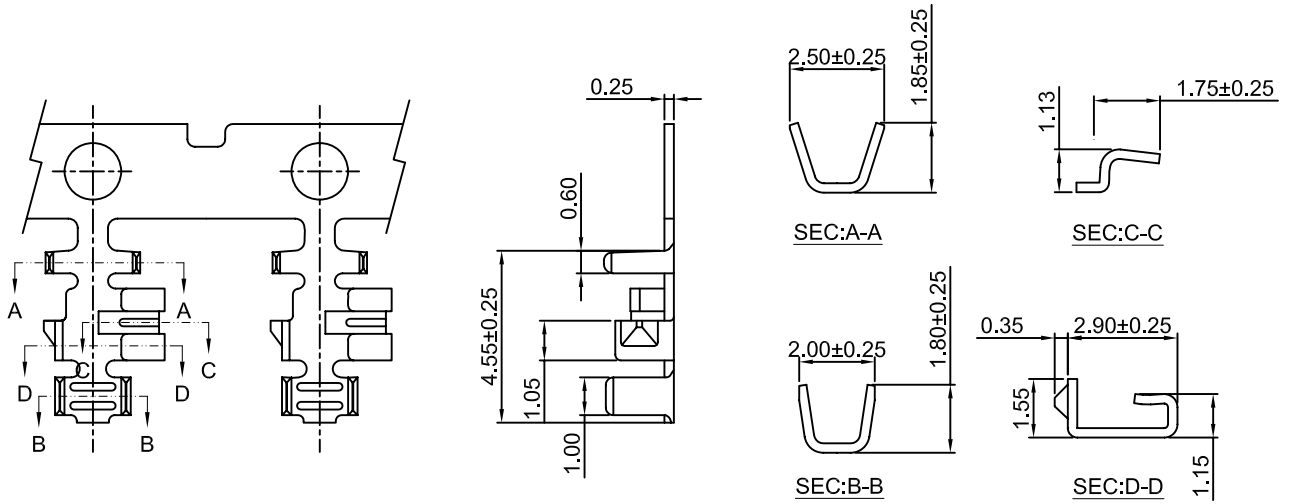

Ordering information & Specifications:

Unit:mm

| Part NO. | Wire Range | Insulation O.D. | Material | Finish | Qty/reel |
|----------|------------|-----------------|-----------------|------------------|------------|
| A2007-TP | AWG#22-#26 | 1.50mm(max) | Phosphor Bronze | Tin over Nickel | 10,000 PCS |
| A2007-GP | AWG#22-#26 | 1.50mm(max) | Phosphor Bronze | Gold over Nickel | 10,000 PCS |

Optional Gold plating available but MOQ requested

A2007H-XP

2.00mm pitch Housing

Reference Informations:

*Material:Nylon 66,UL94V-0

*Suitable CJT A2007 series Terminal

*Mates with CJT A2007 series Wafer

*Color:White

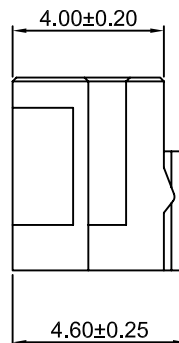
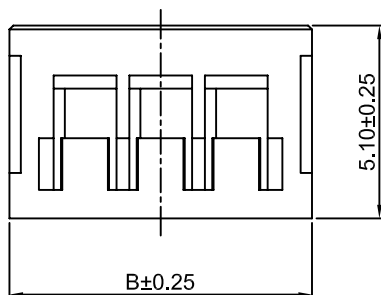
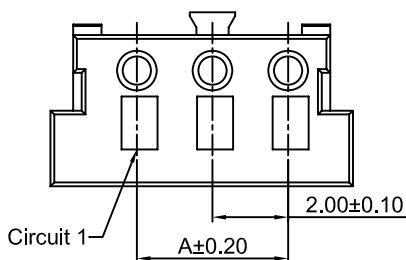
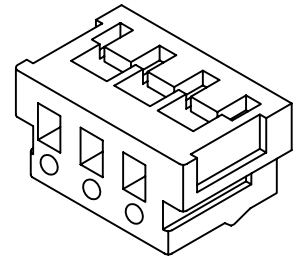

Ordering Information & Dimensions:

| PART NO. | Dimensions | |
|----------|------------|-------|
| | A | B |
| 2P | 2.00 | 5.60 |
| 3P | 4.00 | 7.60 |
| 4P | 6.00 | 9.60 |
| 5P | 8.00 | 11.60 |
| 6P | 10.00 | 13.60 |
| 7P | 12.00 | 15.60 |
| 8P | 14.00 | 17.60 |
| 9P | 16.00 | 19.60 |
| 10P | 18.00 | 21.60 |
| 11P | 20.00 | 23.60 |
| 12P | 22.00 | 25.60 |
| 13P | 24.00 | 27.60 |
| 14P | 26.00 | 29.60 |
| 15P | 28.00 | 31.60 |

Unit: mm

A2007WV-XP

2.00mm pitch 180° Wafer

Reference Informations:

- *Material:Pin:Brass/Tin over Nickel
Insulator:Nylon 66,UL94V-0
- *Mates with CJT A2007 series Housing
- *Color:White

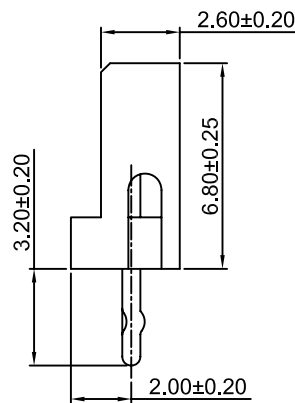
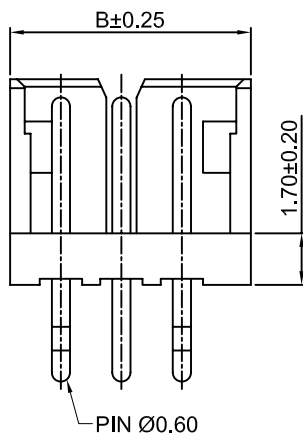
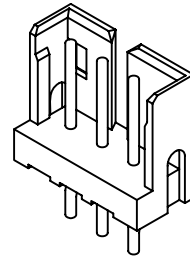
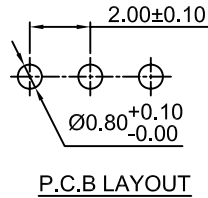
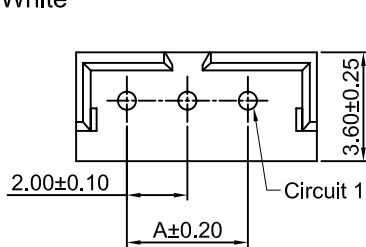

Ordering Information & Dimensions:

| PART NO. | Dimensions | |
|----------|------------|-------|
| | A | B |
| 2P | 2.00 | 5.96 |
| 3P | 4.00 | 7.96 |
| 4P | 6.00 | 9.96 |
| 5P | 8.00 | 11.96 |
| 6P | 10.00 | 13.96 |
| 7P | 12.00 | 15.96 |
| 8P | 14.00 | 17.96 |
| 9P | 16.00 | 19.96 |
| 10P | 18.00 | 21.96 |
| 11P | 20.00 | 23.96 |
| 12P | 22.00 | 25.96 |
| 13P | 24.00 | 27.96 |
| 14P | 26.00 | 29.96 |
| 15P | 28.00 | 31.96 |

Unit: mm

A2007WR-XP

2.00mm pitch 90° Wafer

Reference Informations:

- *Material:Pin:Brass/Tin over Nickel
Insulator:Nylon 66,UL94V-0
- *Mates with CJT A2007 series Housing
- *Color:White

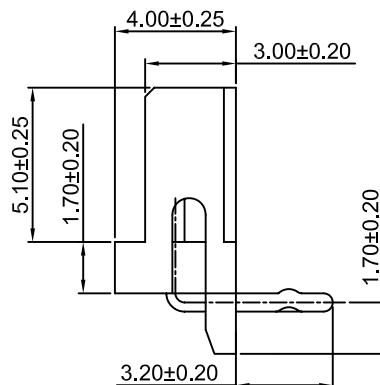
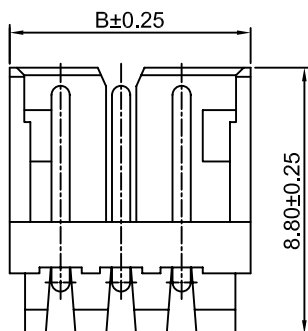
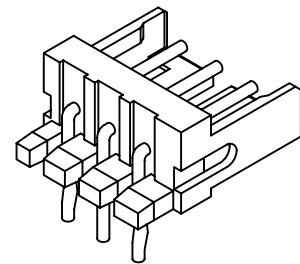
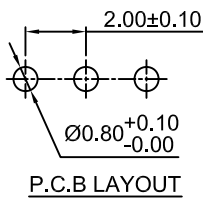
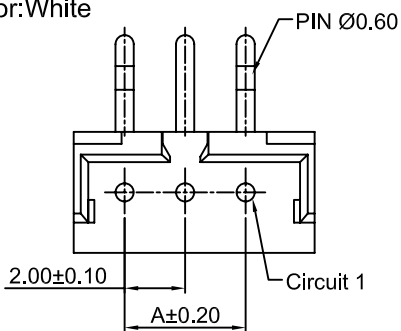

Ordering Information & Dimensions:

| PART NO. | Dimensions | |
|----------|------------|-------|
| | A | B |
| 2P | 2.00 | 5.96 |
| 3P | 4.00 | 7.96 |
| 4P | 6.00 | 9.96 |
| 5P | 8.00 | 11.96 |
| 6P | 10.00 | 13.96 |
| 7P | 12.00 | 15.96 |
| 8P | 14.00 | 17.96 |
| 9P | 16.00 | 19.96 |
| 10P | 18.00 | 21.96 |
| 11P | 20.00 | 23.96 |
| 12P | 22.00 | 25.96 |
| 13P | 24.00 | 27.96 |
| 14P | 26.00 | 29.96 |
| 15P | 28.00 | 31.96 |

Unit: mm

A2007WVD-XP

2.00mm pitch 180° Wafer

Reference Informations:

- *Material: Pin: Brass/Tin over Nickel
Insulator: Nylon 66, UL94V-0
- *Mates with CJT A2007 series Housing
- *Color: White

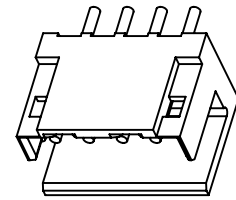
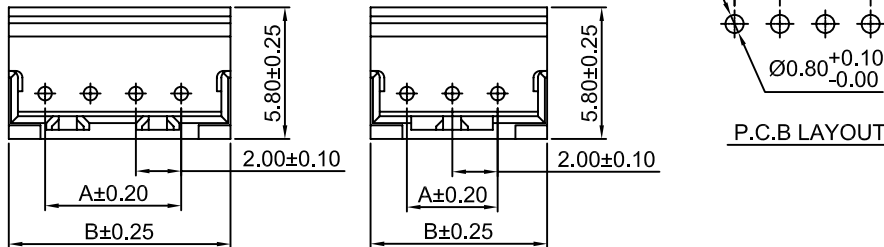

Ordering Information & Dimensions:

| PART NO. | Dimensions | |
|----------|------------|-------|
| | A | B |
| 2P | 2.00 | 5.80 |
| 3P | 4.00 | 7.80 |
| 4P | 6.00 | 9.80 |
| 5P | 8.00 | 11.80 |
| 6P | 10.00 | 13.80 |
| 7P | 12.00 | 15.80 |
| 8P | 14.00 | 17.80 |
| 9P | 16.00 | 19.80 |
| 10P | 18.00 | 21.80 |
| 11P | 20.00 | 23.80 |
| 12P | 22.00 | 25.80 |
| 13P | 24.00 | 27.80 |
| 14P | 26.00 | 29.80 |
| 15P | 28.00 | 31.80 |

Unit: mm

A2007WRD-XP

2.00mm pitch 90° Wafer

Reference Informations:

- *Material: Pin: Brass/Tin over Nickel
Insulator: Nylon 66, UL94V-0
- *Mates with CJT A2007 series Housing
- *Color: White

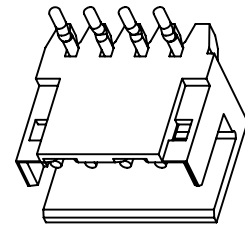
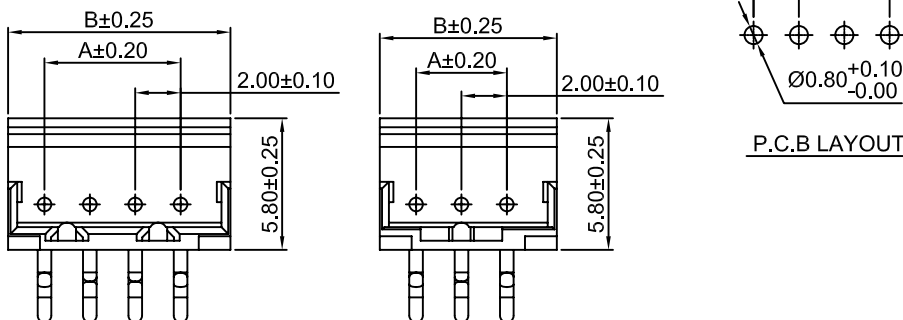

Ordering Information & Dimensions:

| PART NO. | Dimensions | |
|----------|------------|-------|
| | A | B |
| 2P | 2.00 | 5.80 |
| 3P | 4.00 | 7.80 |
| 4P | 6.00 | 9.80 |
| 5P | 8.00 | 11.80 |
| 6P | 10.00 | 13.80 |
| 7P | 12.00 | 15.80 |
| 8P | 14.00 | 17.80 |
| 9P | 16.00 | 19.80 |
| 10P | 18.00 | 21.80 |
| 11P | 20.00 | 23.80 |
| 12P | 22.00 | 25.80 |
| 13P | 24.00 | 27.80 |
| 14P | 26.00 | 29.80 |
| 15P | 28.00 | 31.80 |

Unit: mm

A2007WV-F-3P

2.00mm pitch 180° Wafer With Foot

Reference Informations:

- *Material:Pin:Brass/Tin over Nickel
Insulator:Nylon 66,UL94V-0
- *Mates with CJT A2007 series Housing
- *Color:White

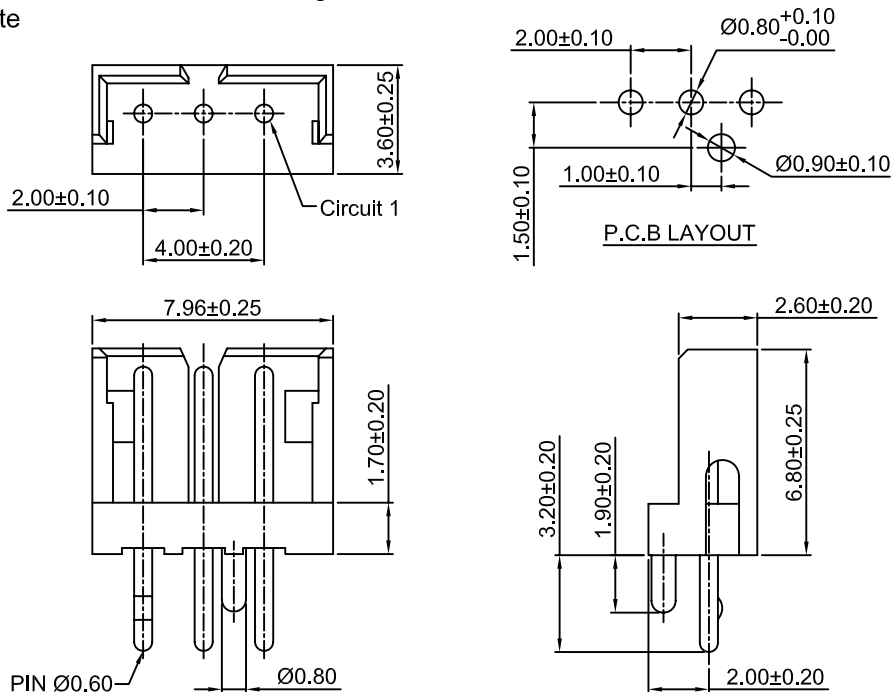

Unit: mm

A2007WR-S-XP

2.00mm pitch 90° Wafer - SMT TYPE

Reference Informations:

- *Material:Pin:Brass/Tin over Nickel
Insulator:Nylon 6T,UL94V-0
- *Mates with CJT A2007 series Housing
- *Color:Beige

Ordering Information:

A2007WR-S-XP - **
1 2

- 1.Part No.
- 2.Color:
(Blank):Beige
BK:Black

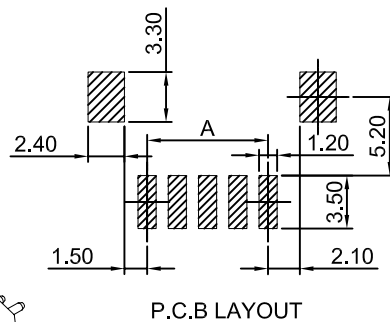
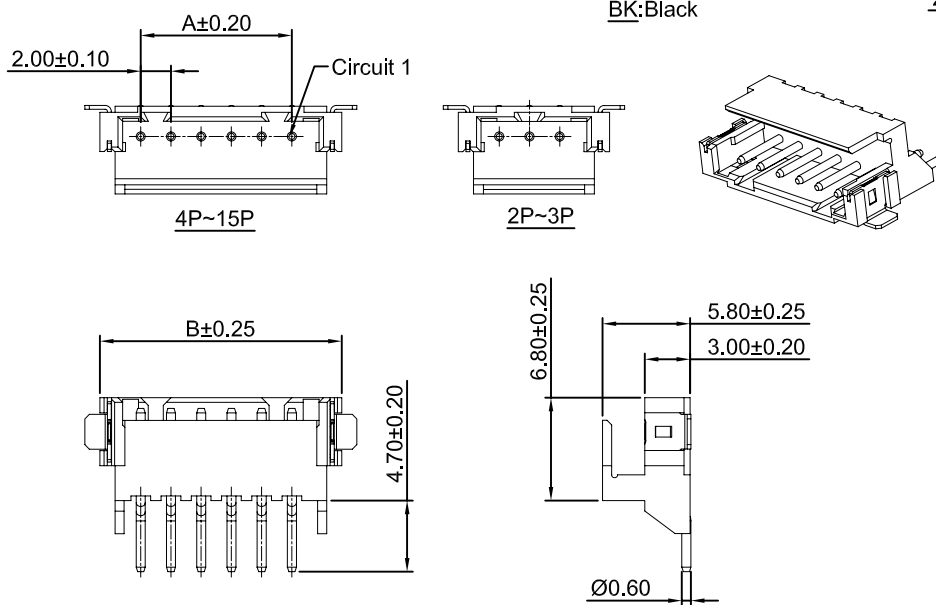

| PART NO. | Dimensions | |
|----------|------------|-------|
| | A | B |
| 2P | 2.00 | 8.00 |
| 3P | 4.00 | 10.00 |
| 4P | 6.00 | 12.00 |
| 5P | 8.00 | 14.00 |
| 6P | 10.00 | 16.00 |
| 7P | 12.00 | 18.00 |
| 8P | 14.00 | 20.00 |
| 9P | 16.00 | 22.00 |
| 10P | 18.00 | 24.00 |
| 11P | 20.00 | 26.00 |
| 12P | 22.00 | 28.00 |
| 13P | 24.00 | 30.00 |
| 14P | 26.00 | 32.00 |
| 15P | 28.00 | 34.00 |

Unit: mm

A2007WR-S-F-XP

2.00mm pitch 90° Wafer - SMT TYPE

Reference Informations:

- *Material: Pin: Brass/Tin over Nickel
Insulator: Nylon 6T, UL94V-0
- *Mates with CJT A2007 series Housing
- *Color: Beige

Ordering Information:

A2007WR-S-F-XP - **

1. Part No.
2. Color:
(Blank): Beige
BK: Black

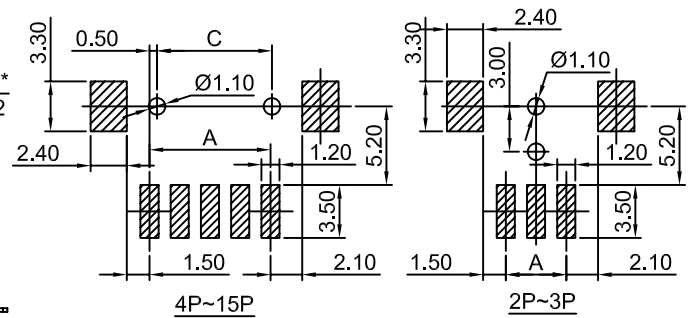

P.C.B LAYOUT

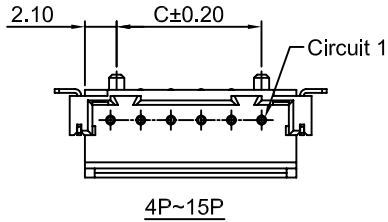

4P~15P

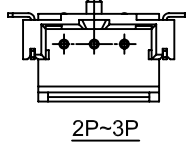

2P~3P

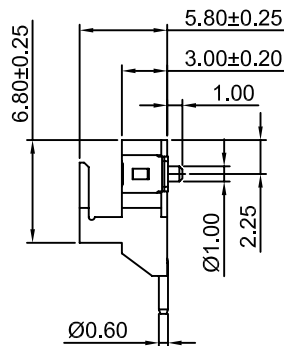
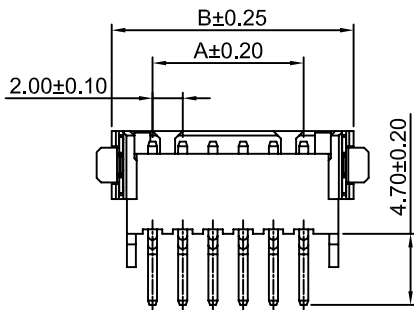

| PART NO. | Dimensions | | |
|----------|------------|-------|-------|
| | A | B | C |
| 2P | 2.00 | 8.00 | ---- |
| 3P | 4.00 | 10.00 | ---- |
| 4P | 6.00 | 12.00 | 5.60 |
| 5P | 8.00 | 14.00 | 7.60 |
| 6P | 10.00 | 16.00 | 9.60 |
| 7P | 12.00 | 18.00 | 11.60 |
| 8P | 14.00 | 20.00 | 13.60 |
| 9P | 16.00 | 22.00 | 15.60 |
| 10P | 18.00 | 24.00 | 17.60 |
| 11P | 20.00 | 26.00 | 19.60 |
| 12P | 22.00 | 28.00 | 21.60 |
| 13P | 24.00 | 30.00 | 23.60 |
| 14P | 26.00 | 32.00 | 25.60 |
| 15P | 28.00 | 34.00 | 27.60 |

Unit: mm

X-ON Electronics

Largest Supplier of Electrical and Electronic Components

Click to view similar products for [Headers & Wire Housings](#) category:

Click to view products by [Changjiang](#) manufacturer:

Other Similar products are found below :

[57102-F02-18ULF](#) [58102-G61-06LF](#) [0009485154](#) [009176003701906](#) [0050291907](#) [00-9021-0611-00-339](#) [02.125.8002.8](#) [609-3404](#) [61062-3](#)
[622-0430](#) [622-3653LF](#) [63453-116](#) [636-1030](#) [636-1427](#) [636-3427](#) [636-4007](#) [641938-9](#) [644827-2](#) [65495-038](#) [65692-001LF](#) [65781-018](#)
[65781-047](#) [65817-010LF](#) [65817-015LF](#) [66207-023LF](#) [67016-026LF](#) [67095-007LF](#) [68631-112](#) [68645-018](#) [68648-049](#) [699319-000](#)
[70.362.1628.0](#) [70-4210](#) [70-4226B](#) [70-4853B](#) [707-5020](#) [707-5028](#) [71.350.2428.0](#) [71961-016LF](#) [733-134](#) [754199-000](#) [760-3052](#) [787-8014-00](#)
[FCN-367T-T012/H](#) [80.063.4001.1](#) [800-90-001-10-001000](#) [800-90-010-10-002000](#) [801-43-002-10-013000](#) [801-43-006-10-002000](#)
[803-41-018-10-001000](#)