

## Specifications

- Current rating:2A AC,DC
- Voltage rating:250V AC,DC
- Temperature range:-40°C~+105°C
- Contact resistance:30mΩMax.
- Insulation resistance:1000MΩMin.
- Withstanding voltage:800V AC/minute
- \*Compliant with RoHS and REACH\*
- \*Meet the HF/Halogen Free,need to customize\*
- \*Contact CJT for details\*

### Standards

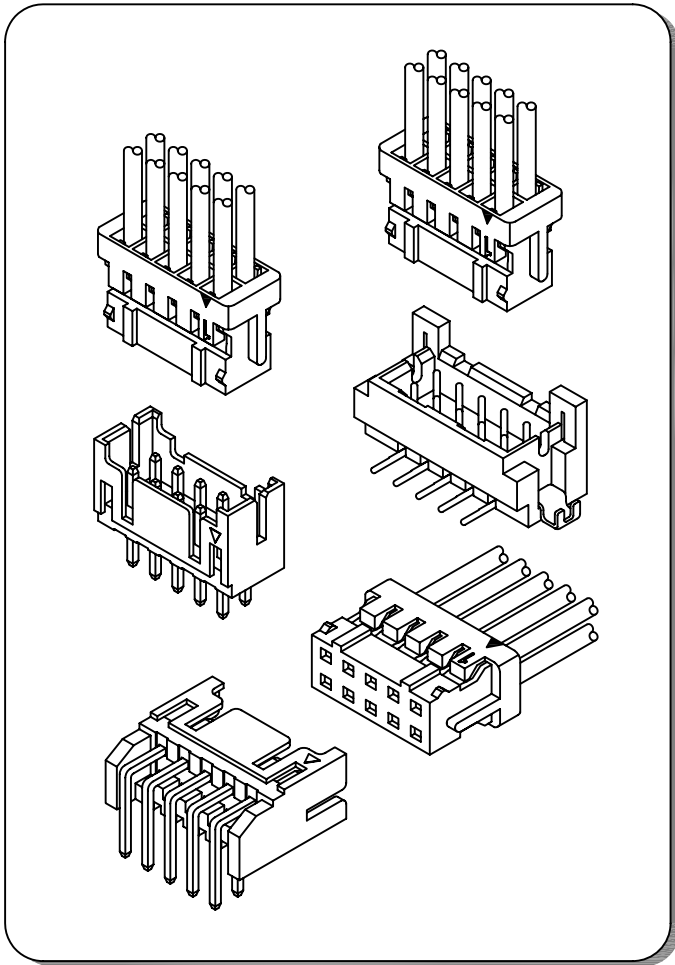

## Assembly layout

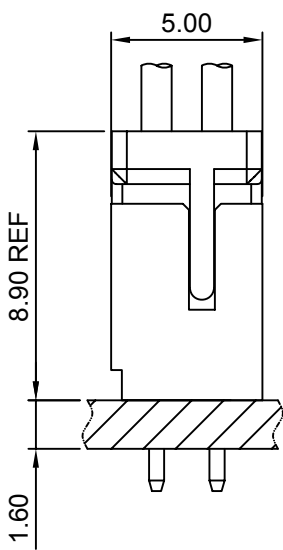

DIP TYPE

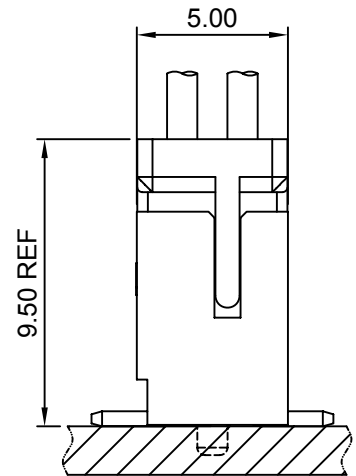
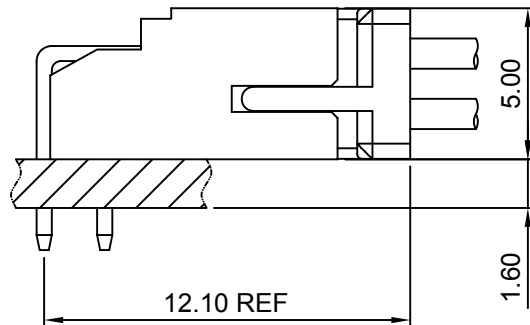

SMT TYPE

### A2009-T

2.00mm pitch Crimp Terminal

#### Reference Informations:

\*Used in CJT A2009 series Housing

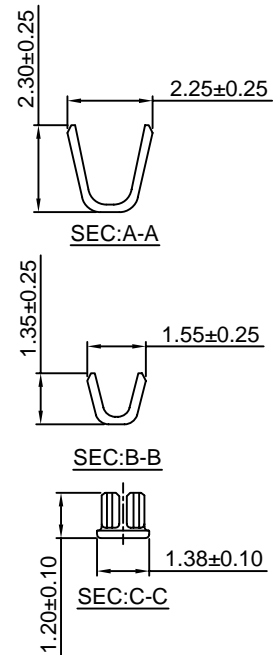
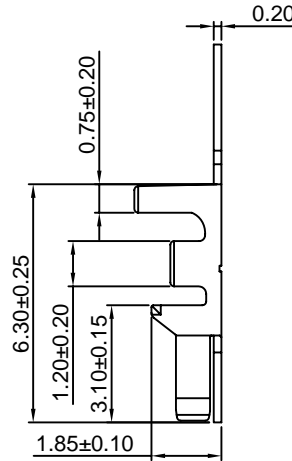
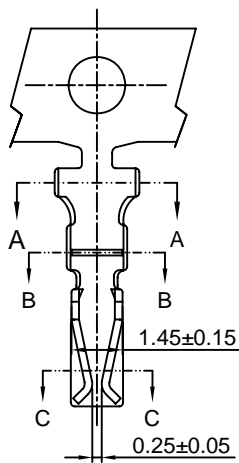

Ordering information & Specifications:

Unit:mm

Part NO.	Wire Range	Insulation O.D.	Material	Finish	Qty/reel
A2009-TP	AWG#22-#30	1.45mm(max)	Phosphor Bronze	Tin over Nickel	10,000 PCS
A2009-GP	AWG#22-#30	1.45mm(max)	Phosphor Bronze	Gold over Nickel	10,000 PCS

Optional Gold plating available but MOQ requested

### A2009H-2

2.00mm pitch Dual Row Housing

#### Reference Informations:

\*Material:Nylon 66,UL94V-0

\*Suitable CJT A2009 series Terminal

\*Mates with CJT A2009 series Dual Row Wafer

\*Color:Black

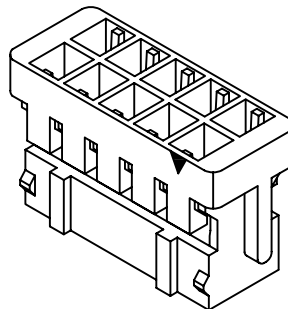
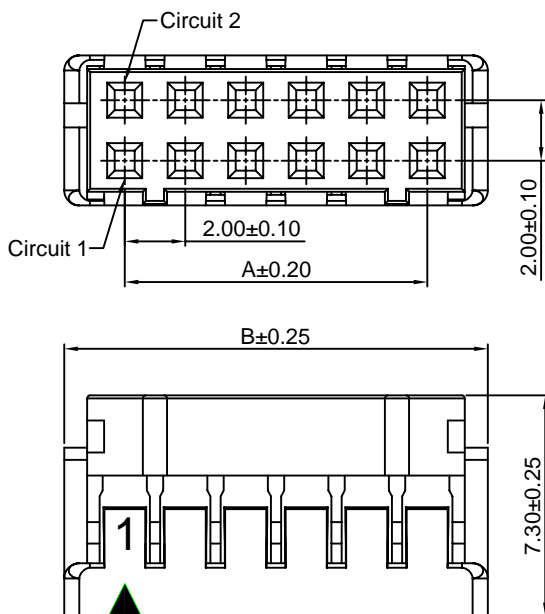

Ordering Information & Dimensions:

PART NO.	Dimensions	
	A	B
A2009H-2x2P	2.00	6.00
A2009H-2x3P	4.00	8.00
A2009H-2x4P	6.00	10.00
A2009H-2x5P	8.00	12.00
A2009H-2x6P	10.00	14.00
A2009H-2x7P	12.00	16.00
A2009H-2x8P	14.00	18.00
A2009H-2x9P	16.00	20.00
A2009H-2x10P	18.00	22.00
A2009H-2x11P	20.00	24.00
A2009H-2x12P	22.00	26.00
A2009H-2x13P	24.00	28.00
A2009H-2x14P	26.00	30.00
A2009H-2x15P	28.00	32.00
A2009H-2x16P	30.00	34.00
A2009H-2x17P	32.00	36.00
A2009H-2x18P	34.00	38.00
A2009H-2x19P	36.00	40.00
A2009H-2x20P	38.00	42.00

Unit: mm

### A2009WV-2

2.00mm pitch 180° Dual Row Wafer

#### Reference Informations:

- \*Material:Pin:Brass/Tin over Nickel  
Insulator:Nylon 66,UL94V-0
- \*Mates with CJT A2009 series Housing
- \*Color:Black

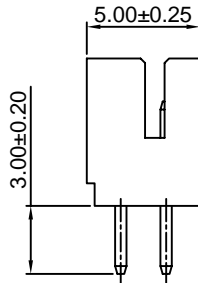
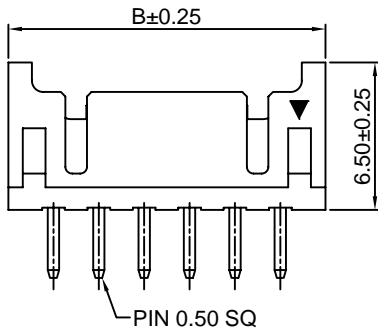
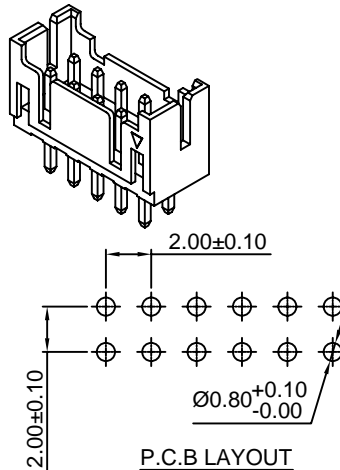
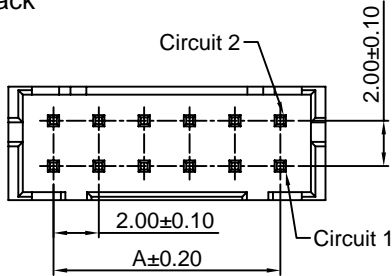

#### Ordering Information & Dimensions:

PART NO.	Dimensions	
	A	B
A2009WV-2x2P	2.00	6.00
A2009WV-2x3P	4.00	8.00
A2009WV-2x4P	6.00	10.00
A2009WV-2x5P	8.00	12.00
A2009WV-2x6P	10.00	14.00
A2009WV-2x7P	12.00	16.00
A2009WV-2x8P	14.00	18.00
A2009WV-2x9P	16.00	20.00
A2009WV-2x10P	18.00	22.00
A2009WV-2x11P	20.00	24.00
A2009WV-2x12P	22.00	26.00
A2009WV-2x13P	24.00	28.00
A2009WV-2x14P	26.00	30.00
A2009WV-2x15P	28.00	32.00
A2009WV-2x16P	30.00	34.00
A2009WV-2x17P	32.00	36.00
A2009WV-2x18P	34.00	38.00
A2009WV-2x19P	36.00	40.00
A2009WV-2x20P	38.00	42.00

Unit: mm

### A2009WR-2

2.00mm pitch 90° Dual Row Wafer

#### Reference Informations:

- \*Material:Pin:Brass/Tin over Nickel  
Wafer:Nylon 66,UL94V-0
- \*Mates with CJT A2009 series dual row Housing
- \*Color:Black

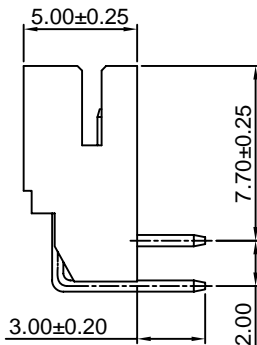
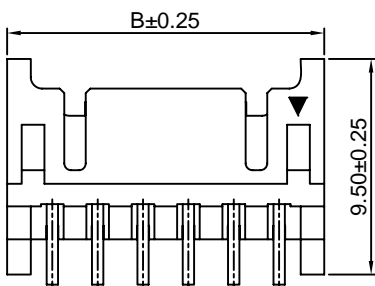
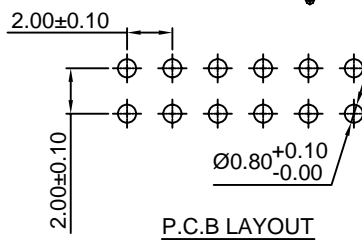
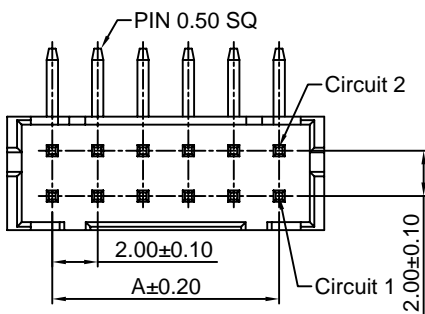

#### Ordering Information & Dimensions:

PART NO.	Dimensions	
	A	B
A2009WR-2x2P	2.00	6.00
A2009WR-2x3P	4.00	8.00
A2009WR-2x4P	6.00	10.00
A2009WR-2x5P	8.00	12.00
A2009WR-2x6P	10.00	14.00
A2009WR-2x7P	12.00	16.00
A2009WR-2x8P	14.00	18.00
A2009WR-2x9P	16.00	20.00
A2009WR-2x10P	18.00	22.00
A2009WR-2x11P	20.00	24.00
A2009WR-2x12P	22.00	26.00
A2009WR-2x13P	24.00	28.00
A2009WR-2x14P	26.00	30.00
A2009WR-2x15P	28.00	32.00
A2009WR-2x16P	30.00	34.00
A2009WR-2x17P	32.00	36.00
A2009WR-2x18P	34.00	38.00
A2009WR-2x19P	36.00	40.00
A2009WR-2x20P	38.00	42.00

Unit: mm

### A2009WVA-S-F-2

2.00mm pitch 180° Dual Row Wafer With Boss-SMT TYPE

#### Reference Informations:

- \*Material: Pin: Brass/Tin over Nickel  
Insulator: Nylon 6T, UL94V-0  
Cap: Nylon 6T, UL94V-0
- \*Mates with CJT A2009 series Dual Row Housing
- \*Color: Ivory

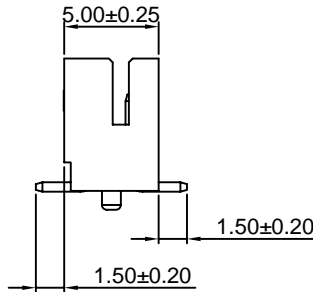
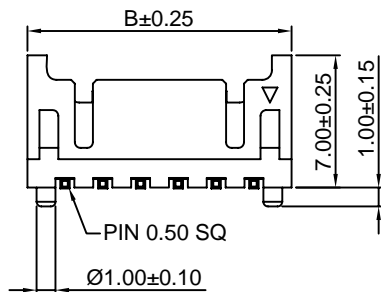
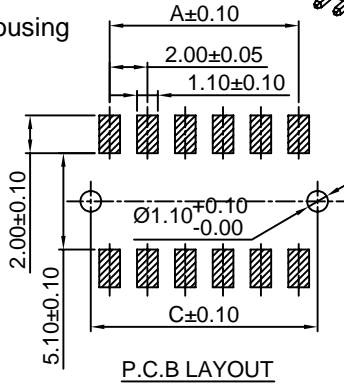
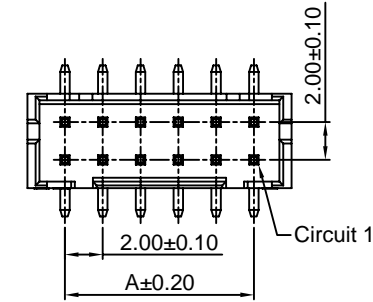
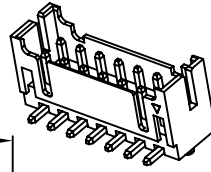

#### Ordering Information & Dimensions:

PART NO.	Dimensions		
	A	B	C
A2009WVA-S-F-2x2P	2.00	6.00	4.00
A2009WVA-S-F-2x3P	4.00	8.00	6.00
A2009WVA-S-F-2x4P	6.00	10.00	8.00
A2009WVA-S-F-2x5P	8.00	12.00	10.00
A2009WVA-S-F-2x6P	10.00	14.00	12.00
A2009WVA-S-F-2x7P	12.00	16.00	14.00
A2009WVA-S-F-2x8P	14.00	18.00	16.00
A2009WVA-S-F-2x9P	16.00	20.00	18.00
A2009WVA-S-F-2x10P	18.00	22.00	20.00
A2009WVA-S-F-2x11P	20.00	24.00	22.00
A2009WVA-S-F-2x12P	22.00	26.00	24.00
A2009WVA-S-F-2x13P	24.00	28.00	26.00
A2009WVA-S-F-2x14P	26.00	30.00	28.00
A2009WVA-S-F-2x15P	28.00	32.00	30.00
A2009WVA-S-F-2x16P	30.00	34.00	32.00
A2009WVA-S-F-2x17P	32.00	36.00	34.00
A2009WVA-S-F-2x18P	34.00	38.00	36.00
A2009WVA-S-F-2x19P	36.00	40.00	38.00
A2009WVA-S-F-2x20P	38.00	42.00	40.00

Unit: mm

## X-ON Electronics

Largest Supplier of Electrical and Electronic Components

*Click to view similar products for [Headers & Wire Housings](#) category:*

*Click to view products by [Changjiang](#) manufacturer:*

Other Similar products are found below :

[57102-F02-18ULF](#) [58102-G61-06LF](#) [0009485154](#) [009176003701906](#) [0050291907](#) [00-9021-0611-00-339](#) [02.125.8002.8](#) [609-3404](#) [61062-3](#)  
[622-0430](#) [622-3653LF](#) [63453-116](#) [636-1030](#) [636-1427](#) [636-3427](#) [636-4007](#) [641938-9](#) [644827-2](#) [65495-038](#) [65692-001LF](#) [65781-018](#)  
[65781-047](#) [65817-010LF](#) [65817-015LF](#) [66207-023LF](#) [67016-026LF](#) [67095-007LF](#) [68631-112](#) [68645-018](#) [68648-049](#) [699319-000](#)  
[70.362.1628.0](#) [70-4210](#) [70-4226B](#) [70-4853B](#) [707-5020](#) [707-5028](#) [71.350.2428.0](#) [71961-016LF](#) [733-134](#) [754199-000](#) [760-3052](#) [787-8014-00](#)  
[FCN-367T-T012/H](#) [80.063.4001.1](#) [800-90-001-10-001000](#) [800-90-010-10-002000](#) [801-43-002-10-013000](#) [801-43-006-10-002000](#)  
[803-41-018-10-001000](#)