

## Specifications

- Current rating: 3A AC, DC
- Voltage rating: 250V AC, DC
- Temperature range: -40°C ~ +105°C
- Contact resistance: 10mΩ Max.
- Insulation resistance: 1000MΩ Min.
- Withstanding voltage: 800V AC/minute
- \*Compliant with RoHS and REACH\*
- \*Meet the HF/Halogen Free, need to customize\*
- \*Contact CJT for details\*

## Standards



## Assembly layout

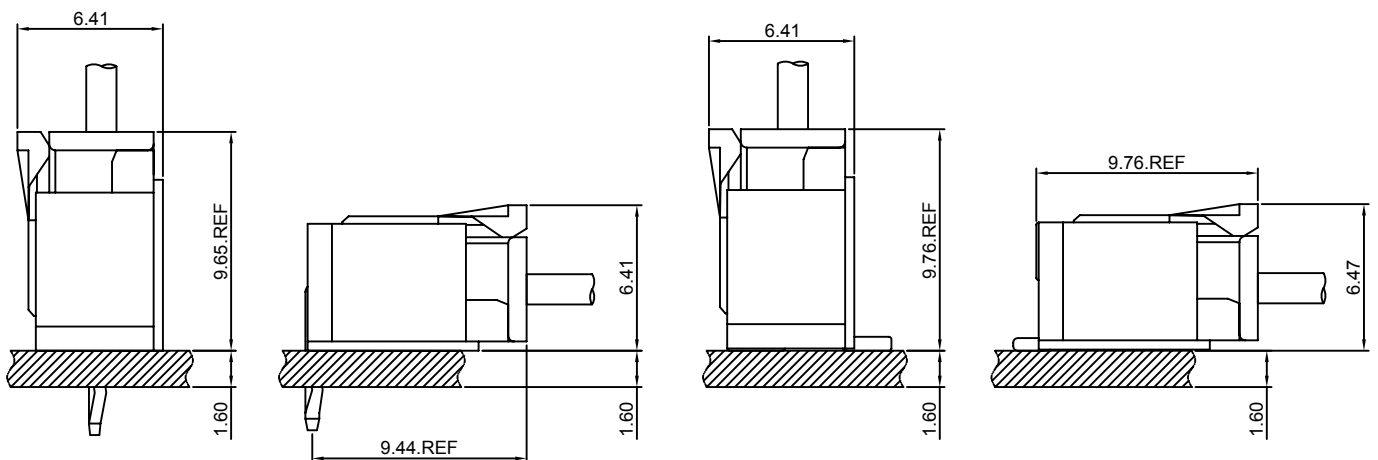

### A2012-T-D

2.00mm pitch Crimp Terminal

**Reference Informations:**

\*Used in CJT A2012HD-2xXP series Dual Row Housing

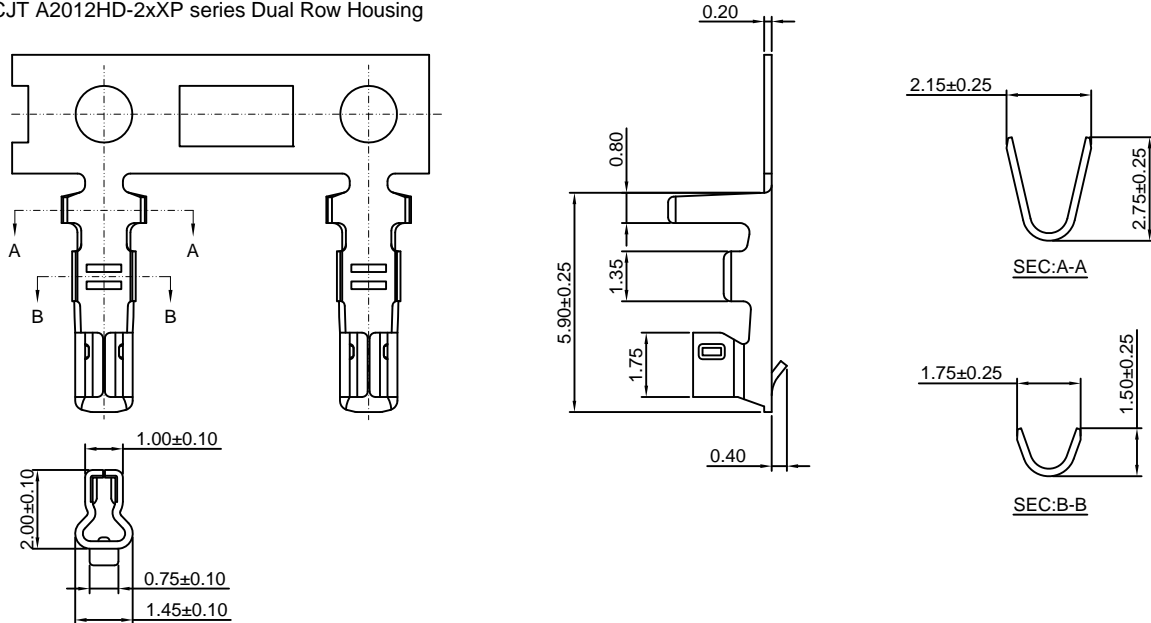

Ordering information & Specifications:

Unit:mm

Part NO.	Wire Range	Insulation O.D.	Material	Finish	Qty/reel
A2012-TP-D	AWG#24-#30	1.50mm(max)	Phosphor Bronze	Tin over Nickel	10,000 PCS
A2012-GP-D	AWG#24-#30	1.50mm(max)	Phosphor Bronze	Gold over Nickel	10,000 PCS

Optional Gold plating available but MOQ requested

### A2012H-XP

2.00mm pitch Housing

**Reference Informations:**

\*Material:Nylon 66,UL94V-0

\*Suitable CJT A2006-T series Terminal

\*Mates with CJT A2012WV,WR,WV-S,WR-S,WV-F-XP, A2012WVA,WRA,WVA-F,WRA-F-XP series Wafer

\*Color:White

Ordering Information:

A2012H-XP - \*\*\* - \*\*  
1 2 3

1.Part No.

2.Material:

(Blank):Nylon 66,UL94V-0

GWT:Nylon 66,UL94V-0,GWT 750 °C

3.Color:

(Blank):White

BK:Black

RD:Red

BL:Blue

GN:Green

OR:Orange

BR:Brown

VI:Violet

PK:Pink

YL:Yellow

LY:Lemon yellow

VY:Vivid yellow

LE:Light blue

GY:Gray

TR:Tomato red

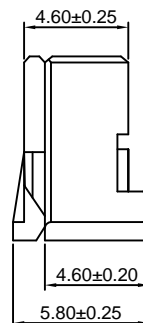
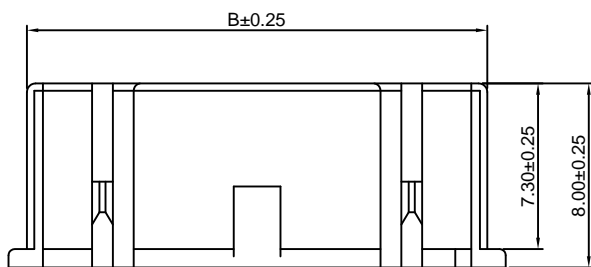
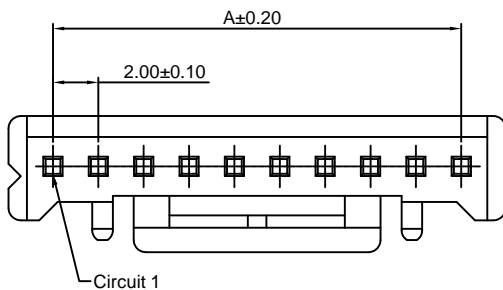
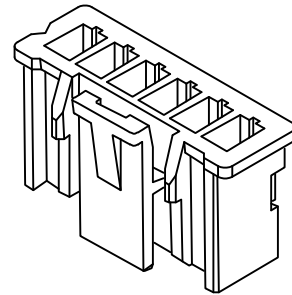

Ordering Information & Dimensions:

PART NO.	Dimensions	
	A	B
2P	2.00	4.30
3P	4.00	6.30
4P	6.00	8.30
5P	8.00	10.30
6P	10.00	12.30
7P	12.00	14.30
8P	14.00	16.30
9P	16.00	18.30
10P	18.00	20.30
11P	20.00	22.30
12P	22.00	24.30
13P	24.00	26.30
14P	26.00	28.30
15P	28.00	30.30
16P	30.00	32.30

Unit: mm

## A2012HD-2xXP

2.00mm pitch Dual Row Housing

### Reference Informations:

- \*Material:Nylon 66,UL94V-0
- \*Suitable CJT A2012-T-D series Terminal
- \*Mates with CJT A2012WV,WV-F,WR-F-2xXP series Dual Row Wafer
- \*Color:White

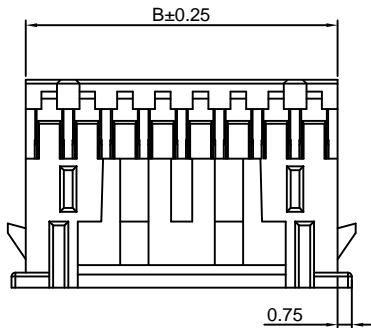
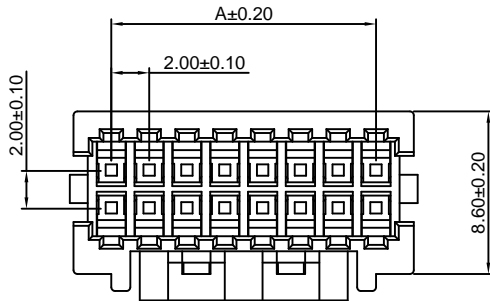

### Ordering Information:

- A2012HD-2xXP - \*\*\*  
 1 2
- 1.Part No.
  - 2.Material:  
 (Blank):Nylon 66,UL94V-0  
 GWT:Nylon 66,UL94V-0,GWT 750 °C

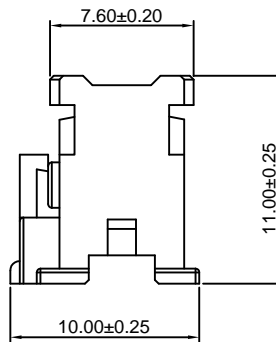

### Ordering Information & Dimensions:

PART NO.	Dimensions	
	A	B
2x2P	2.00	5.00
2x3P	4.00	7.00
2x4P	6.00	9.00
2x5P	8.00	10.50
2x6P	10.00	12.50
2x7P	12.00	14.50
2x8P	14.00	16.50
2x9P	16.00	18.50
2x10P	18.00	20.50
2x11P	20.00	22.50
2x12P	22.00	24.50
2x13P	24.00	26.50
2x14P	26.00	28.50
2x15P	28.00	30.50
2x16P	30.00	32.50
2x17P	32.00	34.50
2x18P	34.00	36.50
2x19P	36.00	38.50
2x20P	38.00	40.50

Unit: mm

## A2012WV-XP

2.00mm pitch 180° Wafer

### Reference Informations:

- \*Material:Pin:Brass/Tin over Nickel  
Insulator:Nylon 6T,UL94V-0
- \*Mates with CJT A2012H-XP series Housing
- \*Color:Ivory

### Ordering Information:

- A2012WV-XP - \*\*\* - \*\*  
 1 2 3
- 1.Part No.
  - 2.Material:  
 (Blank):Nylon 6T,UL94V-0  
 GWT:Nylon 6T,UL94V-0,GWT 750 °C
  - 3.Finish:  
 (blank):Tin over Nickel  
 G:Gold over Nickel

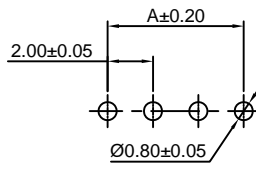
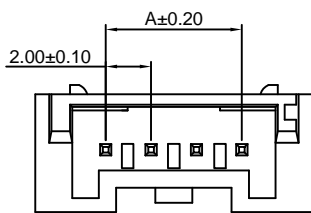

P.C.B LAYOUT

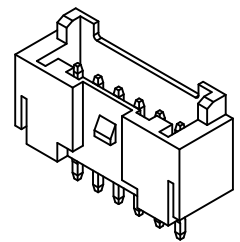
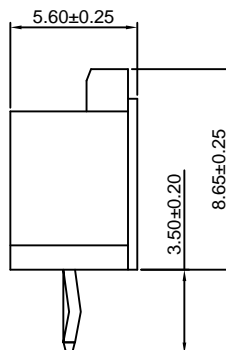
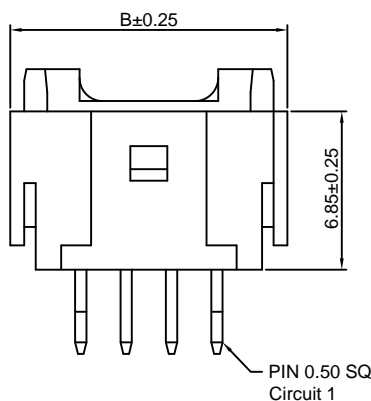

### Ordering Information & Dimensions:

PART NO.	Dimensions	
	A	B
2P	2.00	8.00
3P	4.00	10.00
4P	6.00	12.00
5P	8.00	14.00
6P	10.00	16.00
7P	12.00	18.00
8P	14.00	20.00
9P	16.00	22.00
10P	18.00	24.00
11P	20.00	26.00
12P	22.00	28.00
13P	24.00	30.00
14P	26.00	32.00
15P	28.00	34.00
16P	30.00	36.00

Unit: mm

## A2012WR-XP

2.00mm pitch 90° Wafer

### Reference Informations:

- \*Material:Pin:Brass/Tin over Nickel  
Insulator:Nylon 6T,UL94V-0
- \*Mates with CJT A2012H-XP series Housing
- \*Color:Ivory

### Ordering Information:

- A2012WR-XP - \*\*\* - \*\*  
 1 2 3
- Part No.
  - Material:  
(Blank):Nylon 6T,UL94V-0  
GWT:Nylon 6T,UL94V-0,GWT 750 °C
  - Finish:  
(blank):Tin over Nickel  
G:Gold over Nickel

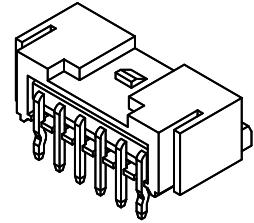
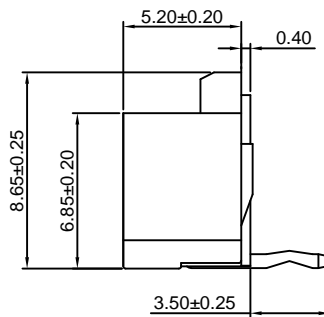
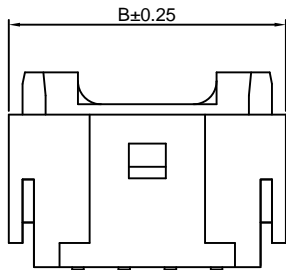
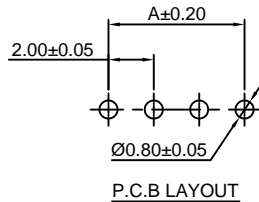
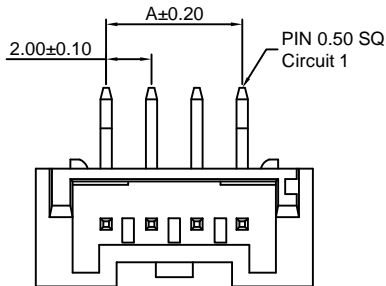

### Ordering Information & Dimensions:

PART NO.	Dimensions	
	A	B
2P	2.00	8.00
3P	4.00	10.00
4P	6.00	12.00
5P	8.00	14.00
6P	10.00	16.00
7P	12.00	18.00
8P	14.00	20.00
9P	16.00	22.00
10P	18.00	24.00
11P	20.00	26.00
12P	22.00	28.00
13P	24.00	30.00
14P	26.00	32.00
15P	28.00	34.00
16P	30.00	36.00

Unit: mm

## A2012WV-S-XP

2.00mm pitch 180° Wafer-SMT TYPE

### Reference Informations:

- \*Material:Pin:Brass/Tin over Nickel  
Insulator:Nylon 6T,UL94V-0
- \*Mates with CJT A2012H-XP series Housing
- \*Color:Ivory

### Ordering Information:

- A2012WV-S-XP - \*\*\* - \*\*  
 1 2 3
- Part No.
  - Material:  
(Blank):Nylon 6T,UL94V-0  
GWT:Nylon 6T,UL94V-0,GWT 750 °C
  - Finish:  
(blank):Tin over Nickel  
G:Gold over Nickel

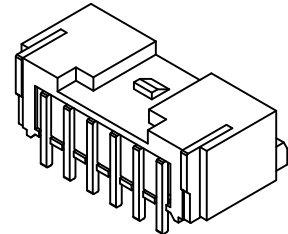
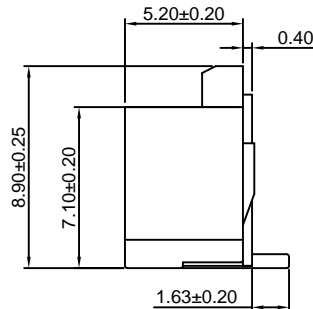
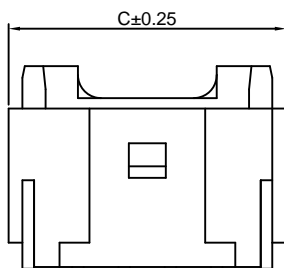
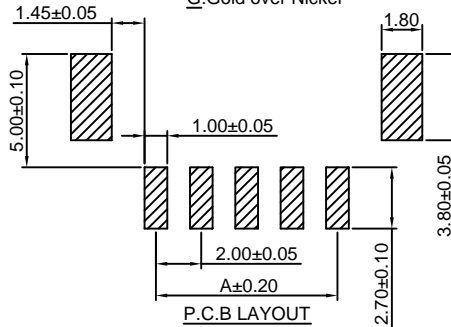
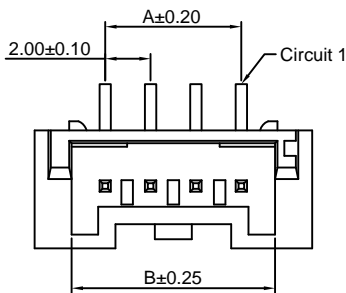

### Ordering Information & Dimensions:

PART NO.	Dimensions		
	A	B	C
2P	2.00	4.50	8.00
3P	4.00	6.50	10.00
4P	6.00	8.50	12.00
5P	8.00	10.50	14.00
6P	10.00	12.50	16.00
7P	12.00	14.50	18.00
8P	14.00	16.50	20.00
9P	16.00	18.50	22.00
10P	18.00	20.50	24.00
11P	20.00	22.50	26.00
12P	22.00	24.50	28.00
13P	24.00	26.50	30.00
14P	26.00	28.50	32.00
15P	28.00	30.50	34.00
16P	30.00	32.50	36.00

Unit: mm

### A2012WR-S-XP

2.00mm pitch 90° Wafer-SMT TYPE

#### Reference Informations:

- \*Material:Pin:Brass/Tin over Nickel  
Insulator:Nylon 6T,UL94V-0
- \*Mates with CJT A2012H-XP series Housing
- \*Color:Ivory

#### Ordering Information:

- A2012WR-S-XP - \*\*\* - \*\*
- |   |   |   |
|---|---|---|
| 1 | 2 | 3 |
|---|---|---|
- 1.Part No.
  - 2.Material:  
(Blank):Nylon 6T,UL94V-0  
GWT:Nylon 6T,UL94V-0,GWT 750 °C
  - 3.Finish:  
(blank):Tin over Nickel  
G:Gold over Nickel

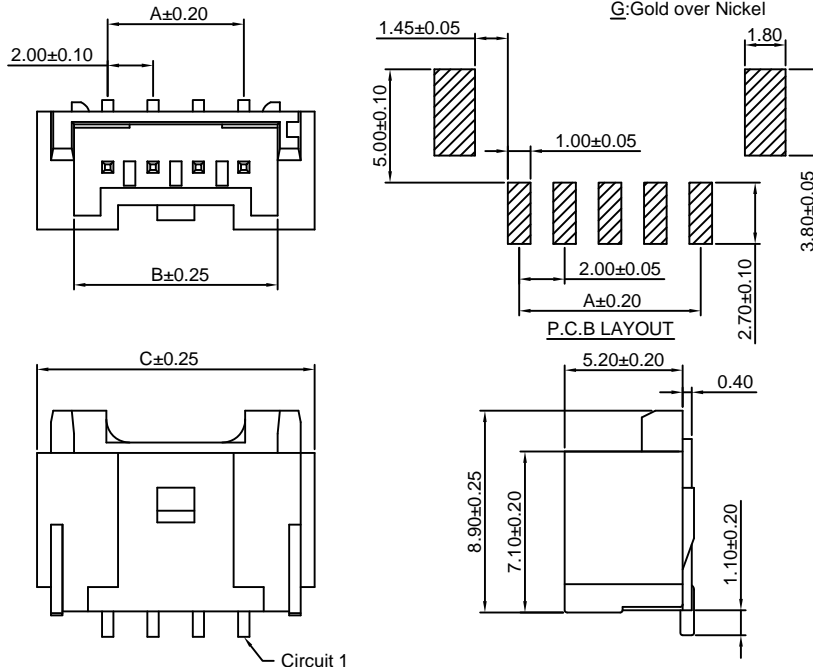
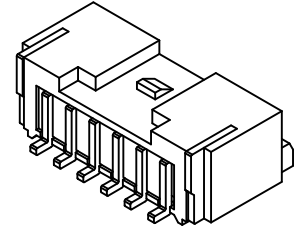

#### Ordering Information & Dimensions:

PART NO.	Dimensions		
	A	B	C
2P	2.00	4.50	8.00
3P	4.00	6.50	10.00
4P	6.00	8.50	12.00
5P	8.00	10.50	14.00
6P	10.00	12.50	16.00
7P	12.00	14.50	18.00
8P	14.00	16.50	20.00
9P	16.00	18.50	22.00
10P	18.00	20.50	24.00
11P	20.00	22.50	26.00
12P	22.00	24.50	28.00
13P	24.00	26.50	30.00
14P	26.00	28.50	32.00
15P	28.00	30.50	34.00
16P	30.00	32.50	36.00

Unit: mm

### A2012WV-F-XP

2.00mm pitch 180° Wafer

#### Reference Informations:

- \*Material:Pin:Brass/Tin over Nickel  
Insulator:Nylon 66,UL94V-0
- \*Mates with CJT A2012H-XP series Housing
- \*Color:Ivory

#### Ordering Information:

- A2012WV-F-XP - \*\*\* - \*\*
- |   |   |   |
|---|---|---|
| 1 | 2 | 3 |
|---|---|---|
- 1.Part No.
  - 2.Material:  
(Blank):Nylon 66,UL94V-0  
GWT:Nylon 66,UL94V-0,GWT 750 °C
  - 3.Finish:  
(blank):Tin over Nickel  
G:Gold over Nickel

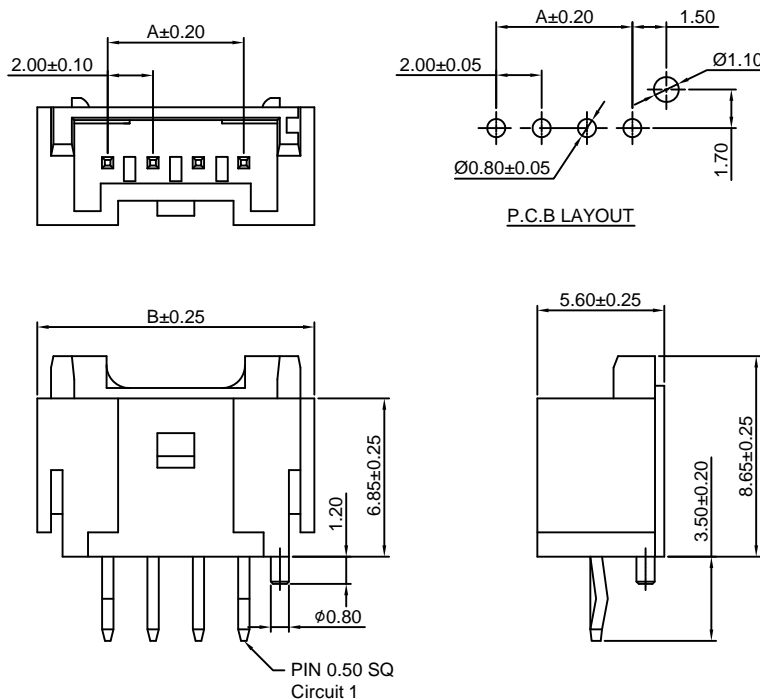

#### Ordering Information & Dimensions:

PART NO.	Dimensions	
	A	B
2P	2.00	8.00
3P	4.00	10.00
4P	6.00	12.00
5P	8.00	14.00
6P	10.00	16.00
7P	12.00	18.00
8P	14.00	20.00
9P	16.00	22.00
10P	18.00	24.00
11P	20.00	26.00
12P	22.00	28.00
13P	24.00	30.00
14P	26.00	32.00
15P	28.00	34.00
16P	30.00	36.00

Unit: mm

# A2012WVA-XP

2.00mm pitch 180° Wafer

#### Reference Informations:

- \*Material:Pin:Brass/Tin over Nickel  
Insulator:Nylon 66,UL94V-0
- \*Mates with CJT A2012H-XP series Housing
- \*Color:White

#### Ordering Information:

A2012WVA-XP - <sup>\*\*\*</sup>/<sub>1</sub> - <sup>\*\*</sup>/<sub>2</sub> - <sup>\*\*</sup>/<sub>3</sub> - <sup>\*\*</sup>/<sub>4</sub>

- Part No.
- Material:  
(Blank):Nylon 66,UL94V-0  
GWT:Nylon 66,UL94V-0,GWT 750 °C
- Color:  
(Blank):White  
BK:Black      PK:Pink  
RD:Red        YL:Yellow  
BL:Blue       LY:Lemon yellow  
GN:Green      VY:Vivid yellow  
OR:Orange     LE:Light blue  
BR:Brown      GY:Gray  
VI:Violet       TR:Tomato red
- Finish:  
(blank):Tin over Nickel  
G:Gold over Nickel

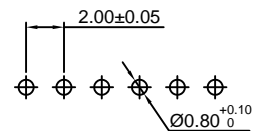
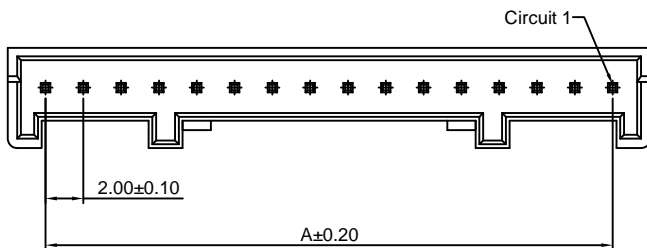
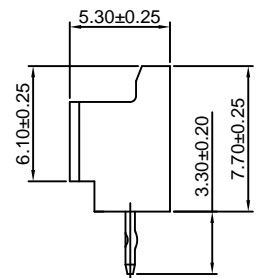
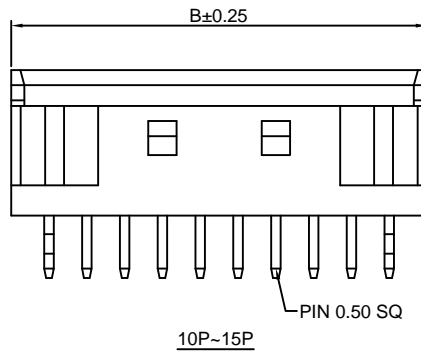
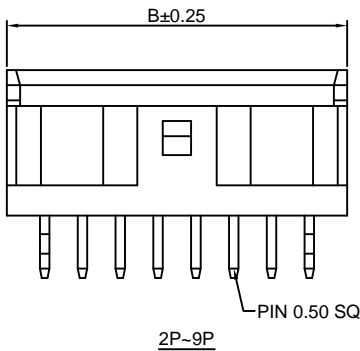
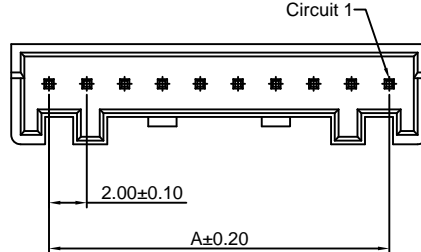
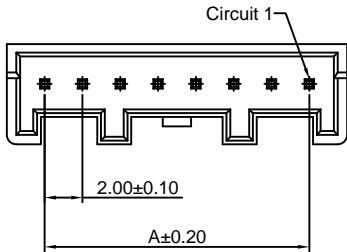

P.C.B LAYOUT

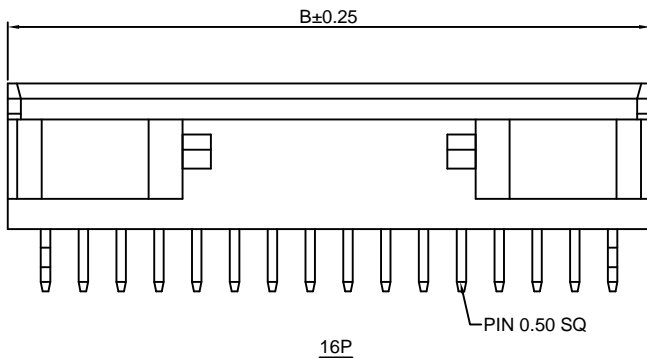

#### Ordering Information & Dimensions:

PART NO.	Dimensions	
	A	B
2P	2.00	6.00
3P	4.00	8.00
4P	6.00	10.00
5P	8.00	12.00
6P	10.00	14.00
7P	12.00	16.00
8P	14.00	18.00
9P	16.00	20.00
10P	18.00	22.00
11P	20.00	24.00
12P	22.00	26.00
13P	24.00	28.00
14P	26.00	30.00
15P	28.00	32.00
16P	30.00	34.00

Unit: mm

# A2012WRA-XP

2.00mm pitch 90° Wafer

#### Reference Informations:

- \*Material:Pin:Brass/Tin over Nickel  
Insulator:Nylon 66,UL94V-0
- \*Mates with CJT A2012H-XP series Housing
- \*Color:White

#### Ordering Information:

A2012WRA-XP - \*\*\* - \*\* - \*\*  
1 2 3 4

- 1.Part No.
- 2.Material:  
(Blank):Nylon 66,UL94V-0  
GWT:Nylon 66,UL94V-0,GWT 750 °C
- 3.Color:  
(Blank):White  
BK:Black                      PK:Pink  
RD:Red                        YL:Yellow  
BL:Blue                       LY:Lemon yellow  
GN:Green                    VY:Vivid yellow  
OR:Orange                  LE:Light blue  
BR:Brown                    GY:Gray  
VI:Violet                    TR:Tomato red
- 4.Finish:  
(blank):Tin over Nickel  
G:Gold over Nickel

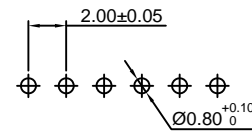
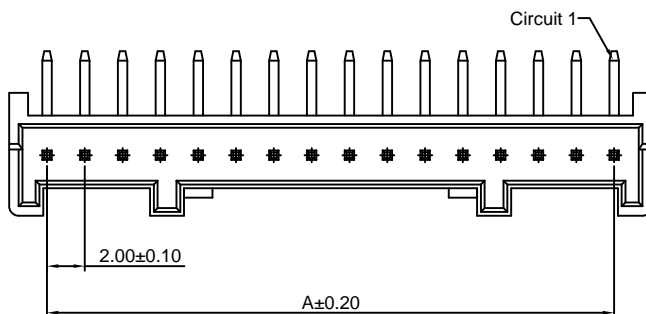
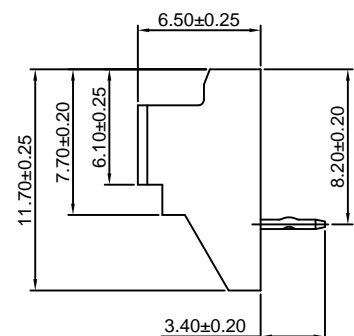
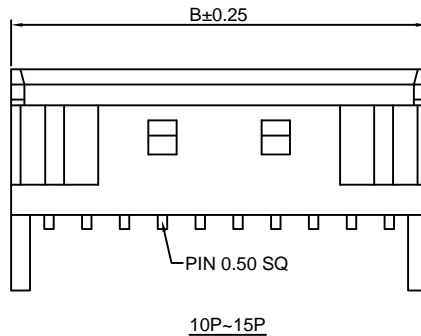
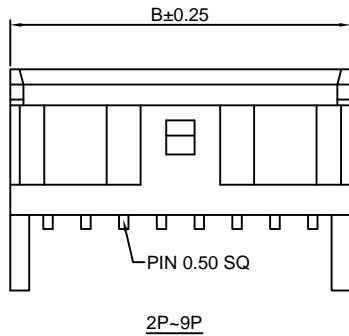
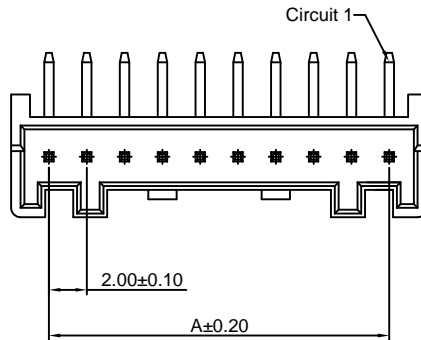
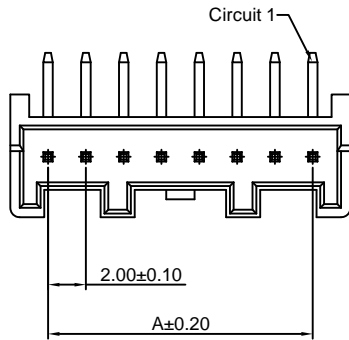

P.C.B LAYOUT

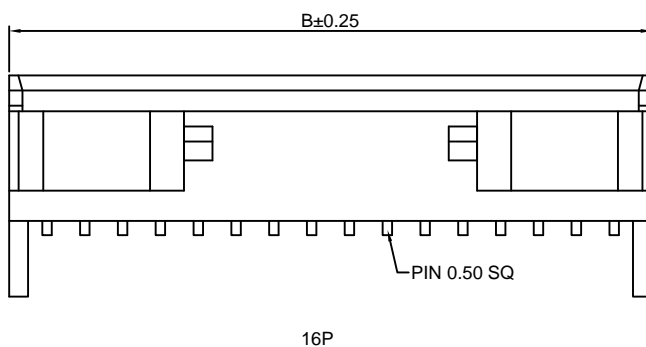

16P

#### Ordering Information & Dimensions:

PART NO.	Dimensions	
	A	B
2P	2.00	6.00
3P	4.00	8.00
4P	6.00	10.00
5P	8.00	12.00
6P	10.00	14.00
7P	12.00	16.00
8P	14.00	18.00
9P	16.00	20.00
10P	18.00	22.00
11P	20.00	24.00
12P	22.00	26.00
13P	24.00	28.00
14P	26.00	30.00
15P	28.00	32.00
16P	30.00	34.00

Unit: mm

### A2012WVA-F-XP

2.00mm pitch 180° Wafer

#### Reference Informations:

- \*Material: Pin: Brass/Tin over Nickel  
Insulator: Nylon 66, UL94V-0
- \*Mates with CJT A2012H-XP series Housing
- \*Color: White

#### Ordering Information:

A2012WVA-F-XP - \*\*\* - \*\* - \*\*  
1 2 3 4

- Part No.
- Material:  
(Blank): Nylon 66, UL94V-0  
GWT: Nylon 66, UL94V-0, GWT 750°C
- Color:  
(Blank): White  
BK: Black      PK: Pink  
RD: Red        YL: Yellow  
BL: Blue       LY: Lemon yellow  
GN: Green      VY: Vivid yellow  
OR: Orange     LE: Light blue  
BR: Brown      GY: Gray  
VI: Violet      TR: Tomato red
- Finish:  
(blank): Tin over Nickel  
G: Gold over Nickel

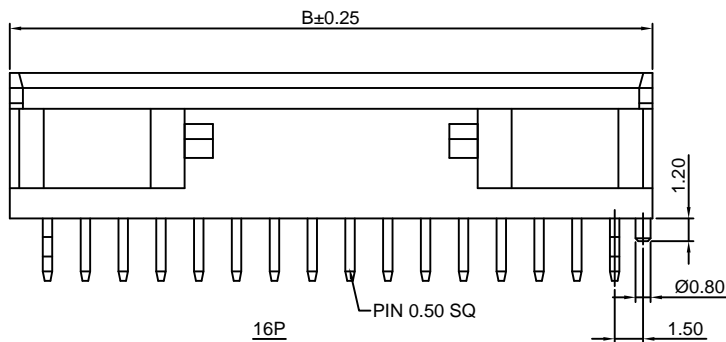
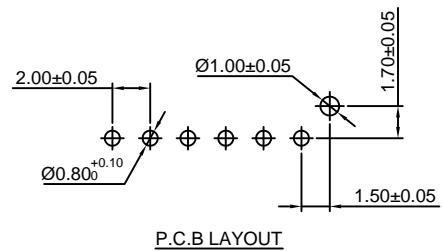
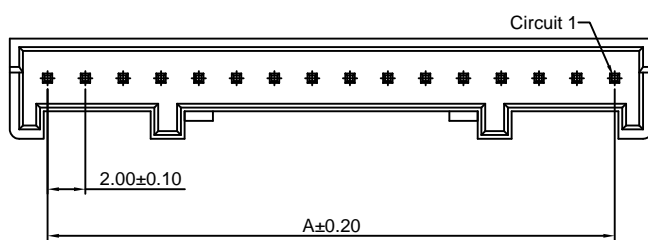
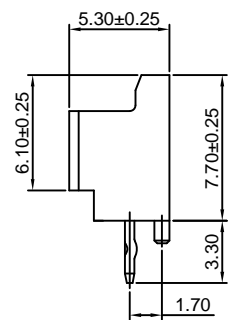
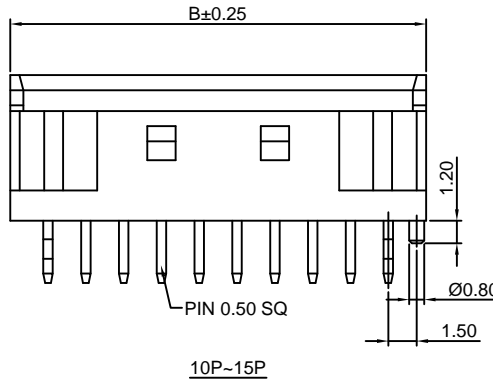
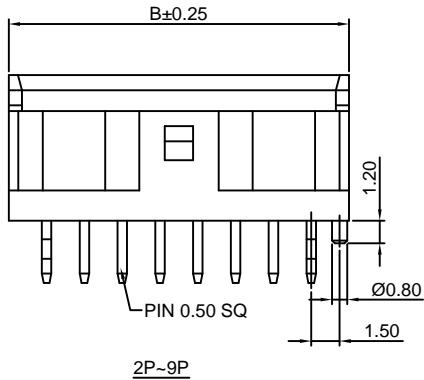
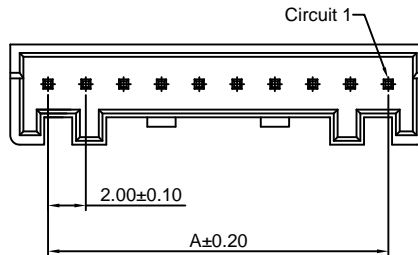
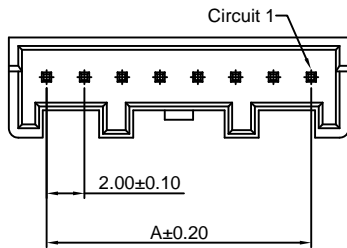

#### Ordering Information & Dimensions:

PART NO.	Dimensions	
	A	B
2P	2.00	6.00
3P	4.00	8.00
4P	6.00	10.00
5P	8.00	12.00
6P	10.00	14.00
7P	12.00	16.00
8P	14.00	18.00
9P	16.00	20.00
10P	18.00	22.00
11P	20.00	24.00
12P	22.00	26.00
13P	24.00	28.00
14P	26.00	30.00
15P	28.00	32.00
16P	30.00	34.00

Unit: mm



## A2012WRA-F-XP

2.00mm pitch 90° Wafer

### Reference Informations:

- \*Material:Pin:Brass/Tin over Nickel  
Insulator:Nylon 66,UL94V-0
- \*Mates with CJT A2012H-XP series Housing
- \*Color:White

### Ordering Information:

A2012WRA-F-XP - \*\*\* - \*\* - \*\*  
1 2 3 4

### 1.Part No.

### 2.Material:

(Blank):Nylon 66,UL94V-0

GWT:Nylon 66,UL94V-0,GWT 750 °C

### 3.Color:

(Blank):White

BK:Black

RD:Red

BL:Blue

GN:Green

OR:Orange

BR:Brown

VI:Violet

PK:Pink

YL:Yellow

LY:Lemon yellow

VY:Vivid yellow

LE:Light blue

GY:Gray

TR:Tomato red

### 4.Finish:

(blank):Tin over Nickel

G:Gold over Nickel

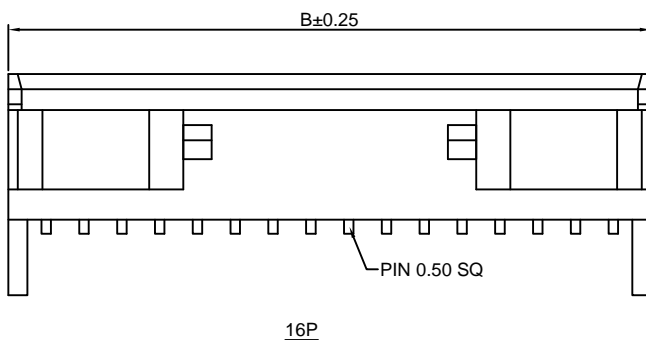
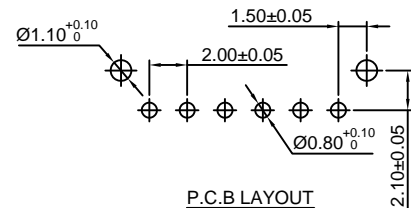
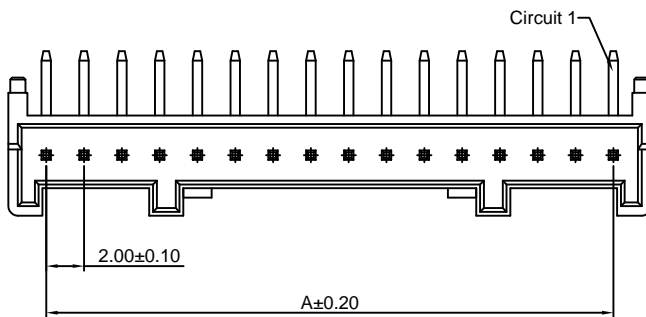
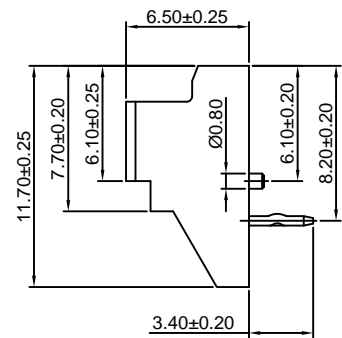
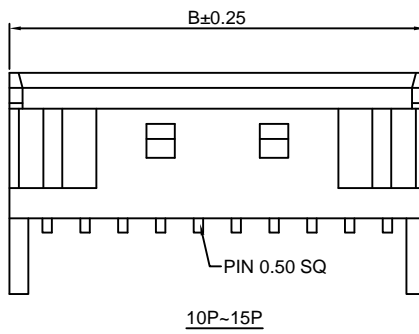
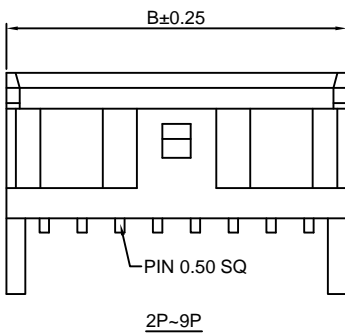
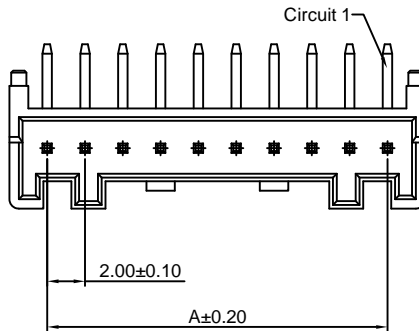
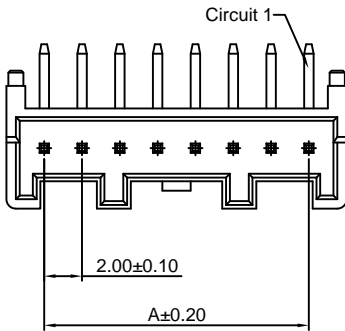

### Ordering Information & Dimensions:

PART NO.	Dimensions	
	A	B
2P	2.00	6.00
3P	4.00	8.00
4P	6.00	10.00
5P	8.00	12.00
6P	10.00	14.00
7P	12.00	16.00
8P	14.00	18.00
9P	16.00	20.00
10P	18.00	22.00
11P	20.00	24.00
12P	22.00	26.00
13P	24.00	28.00
14P	26.00	30.00
15P	28.00	32.00
16P	30.00	34.00

Unit: mm

## A2012WV-2xXP

2.00mm pitch 180° Dual Row Wafer

### Reference Informations:

- \*Material: Pin: Phosphor Bronze/Tin over Nickel  
Insulator: Nylon 66, UL94V-0
- \*Mates with CJT A2012HD-2xXP series Dual Row Housing
- \*Color: Ivory

### Ordering Information:

A2012WV-2xXP - \*\*\* - \*\*  
1 2 3

- Part No.
- Material:  
(Blank): Nylon 66, UL94V-0  
GWT: Nylon 66, UL94V-0, GWT 750 °C
- Finish:  
(blank): Tin over Nickel  
G: Gold over Nickel

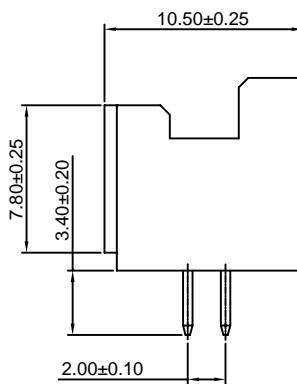
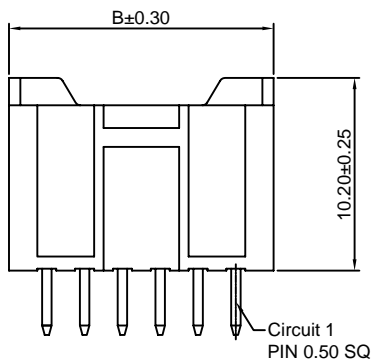
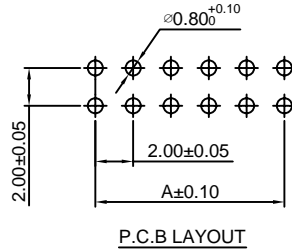
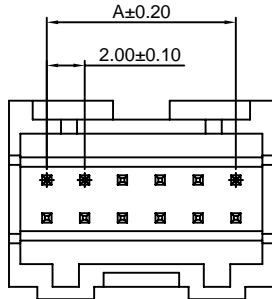

### Ordering Information & Dimensions:

PART NO.	Dimensions	
	A	B
2x5P	8.00	12.00
2x6P	10.00	14.00
2x7P	12.00	16.00
2x8P	14.00	18.00
2x9P	16.00	20.00
2x10P	18.00	22.00
2x11P	20.00	24.00
2x12P	22.00	26.00
2x20P	38.00	42.00

Unit: mm

## A2012WV-F-2xXP

2.00mm pitch 180° Dual Row Wafer

### Reference Informations:

- \*Material: Pin: Phosphor Bronze/Tin over Nickel  
Insulator: Nylon 66, UL94V-0
- \*Mates with CJT A2012HD-2xXP series Dual Row Housing
- \*Color: Ivory

### Ordering Information:

A2012WV-F-2xXP - \*\*\* - \*\*  
1 2 3

- Part No.
- Material:  
(Blank): Nylon 66, UL94V-0  
GWT: Nylon 66, UL94V-0, GWT 750 °C
- Finish:  
(blank): Tin over Nickel  
G: Gold over Nickel

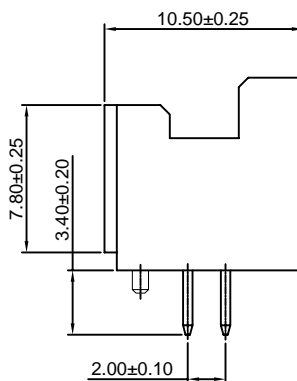
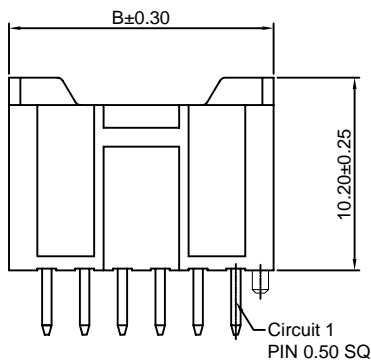
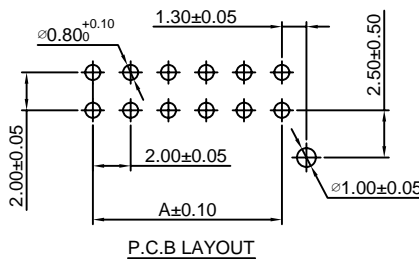
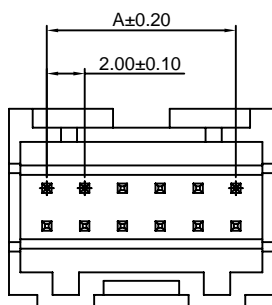

### Ordering Information & Dimensions:

PART NO.	Dimensions	
	A	B
2x5P	8.00	12.00
2x6P	10.00	14.00
2x7P	12.00	16.00
2x8P	14.00	18.00
2x9P	16.00	20.00
2x10P	18.00	22.00
2x11P	20.00	24.00
2x12P	22.00	26.00
2x20P	38.00	42.00

Unit: mm

## A2012WR-F-2xXP

2.00mm pitch 90° Dual Row Wafer

### Reference Informations:

- \*Material: Pin: Phosphor Bronze/Tin over Nickel  
Insulator: Nylon 66, UL94V-0
- \*Mates with CJT A2012HD-2xXP series Dual Row Housing
- \*Color: White

### Ordering Information:

A2012WR-F-2xXP - \*\*\* - \*\*  
1 2 3

1. Part No.
2. Material:  
(Blank): Nylon 66, UL94V-0  
GWT: Nylon 66, UL94V-0, GWT 750°C
3. Finish:  
(blank): Tin over Nickel  
G: Gold over Nickel

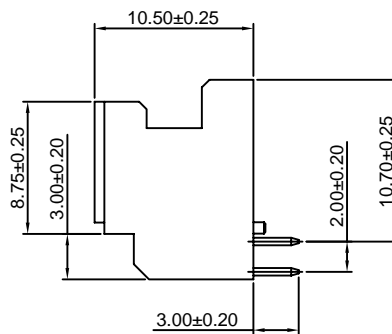
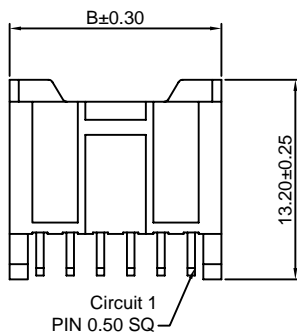
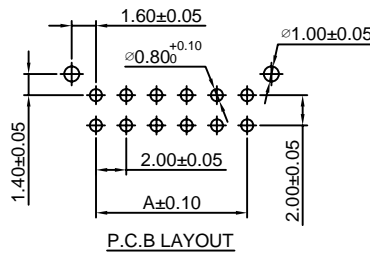
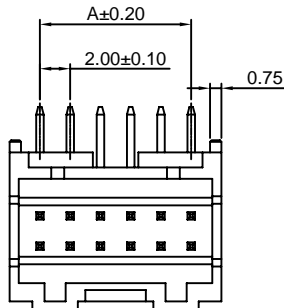

### Ordering Information & Dimensions:

PART NO.	Dimensions	
	A	B
2x5P	8.00	12.00
2x6P	10.00	14.00
2x7P	12.00	16.00
2x8P	14.00	18.00
2x9P	16.00	20.00
2x10P	18.00	22.00
2x11P	20.00	24.00
2x12P	22.00	26.00
2x20P	38.00	42.00

Unit: mm

## X-ON Electronics

Largest Supplier of Electrical and Electronic Components

*Click to view similar products for [Headers & Wire Housings](#) category:*

*Click to view products by [Changjiang](#) manufacturer:*

Other Similar products are found below :

[57102-F02-18ULF](#) [58102-G61-06LF](#) [0009485154](#) [009176003701906](#) [0050291907](#) [00-9021-0611-00-339](#) [02.125.8002.8](#) [609-3404](#) [61062-3](#)  
[622-0430](#) [622-3653LF](#) [63453-116](#) [636-1030](#) [636-1427](#) [636-3427](#) [636-4007](#) [641938-9](#) [644827-2](#) [65495-038](#) [65692-001LF](#) [65781-018](#)  
[65781-047](#) [65817-010LF](#) [65817-015LF](#) [66207-023LF](#) [67016-026LF](#) [67095-007LF](#) [68631-112](#) [68645-018](#) [68648-049](#) [699319-000](#)  
[70.362.1628.0](#) [70-4210](#) [70-4226B](#) [70-4853B](#) [707-5020](#) [707-5028](#) [71.350.2428.0](#) [71961-016LF](#) [733-134](#) [754199-000](#) [760-3052](#) [787-8014-00](#)  
[FCN-367T-T012/H](#) [80.063.4001.1](#) [800-90-001-10-001000](#) [800-90-010-10-002000](#) [801-43-002-10-013000](#) [801-43-006-10-002000](#)  
[803-41-018-10-001000](#)