

Specifications

- Current rating:3A AC,DC
- Voltage rating:250V AC,DC
- Temperature range:-40°C~+105°C
- Contact resistance:10mΩMax.
- Insulation resistance:1000MΩMin.
- Withstanding voltage:800V AC/minute
- *Compliant with RoHS and REACH*
- *Meet the HF/Halogen Free,need to customize*
- *Contact CJT for details*

Standards

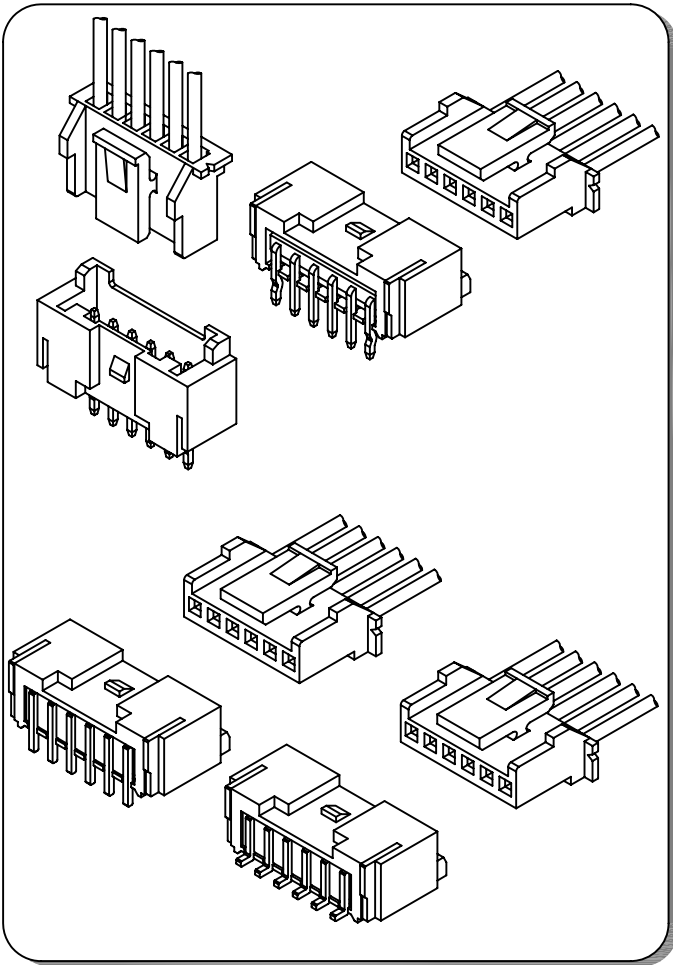

Assembly layout

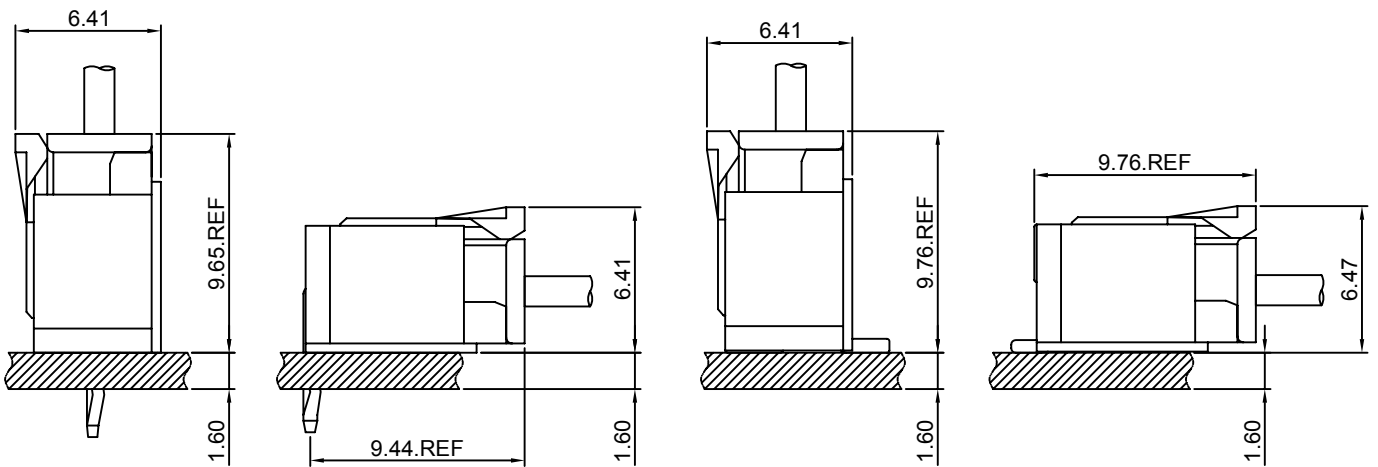

A2012-T

2.00mm pitch Crimp Terminal

Reference Informations:

*Used in CJT A2012HF series Housing

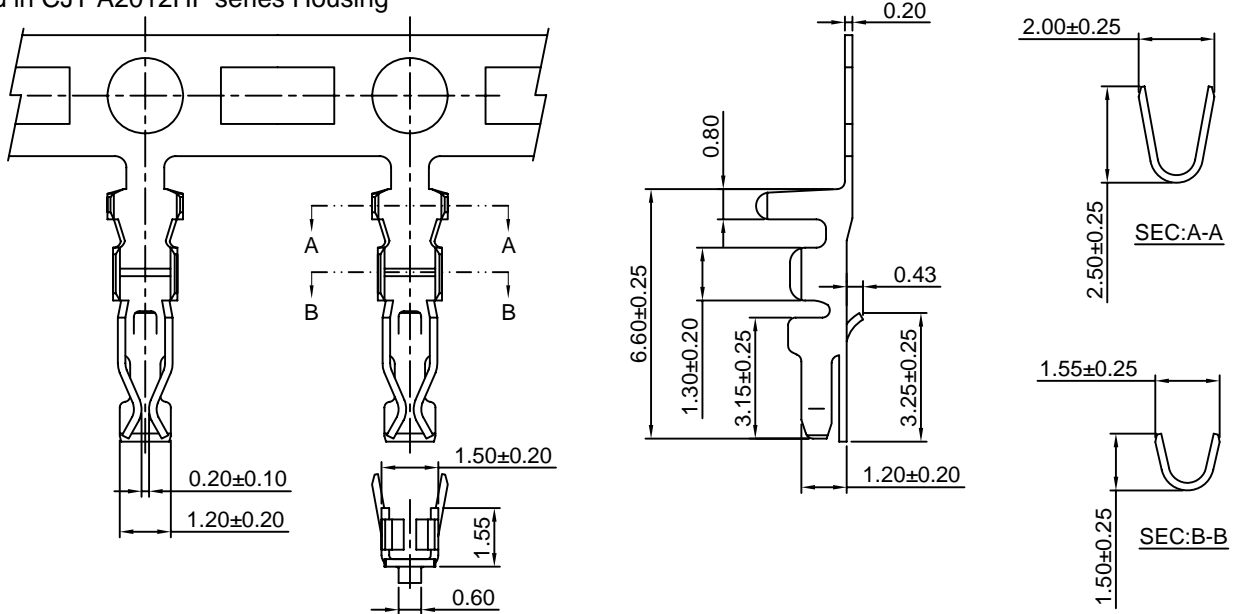

Ordering information & Specifications:

Unit:mm

Part NO	Wire Range	Insulation O.D.	Material	Finish	Qty/reel
A2012-TP	AWG#22-#28	1.50mm(max)	Phosphor Bronze	Tin over Nickel	10,000 PCS
A2012-GP	AWG#22-#28	1.50mm(max)	Phosphor Bronze	Gold over Nickel	10,000 PCS

Optional Gold plating available but MOQ requested

A2012H

2.00mm pitch Housing

Reference Informations:

*Material:Nylon 66,UL94V-0

*Suitable CJT A2012 series Terminal

*Mates with CJT A2012 series Wafer

*Color:White

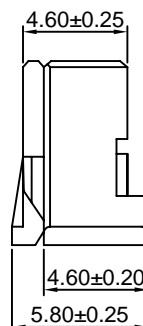
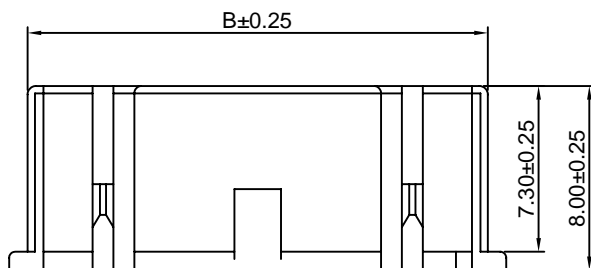
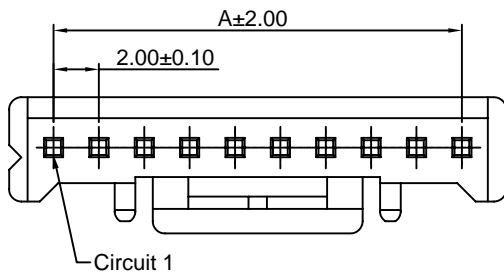
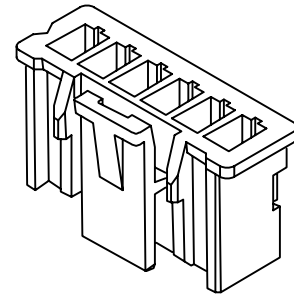

Ordering Information & Dimensions

PART NO.	Dimensions	
	A	B
A2012H-2P	2.00	4.30
A2012H-3P	4.00	6.30
A2012H-4P	6.00	8.30
A2012H-5P	8.00	10.30
A2012H-6P	10.00	12.30
A2012H-7P	12.00	14.30
A2012H-8P	14.00	16.30
A2012H-9P	16.00	18.30
A2012H-10P	18.00	20.30
A2012H-11P	20.00	22.30
A2012H-12P	22.00	24.30
A2012H-13P	24.00	26.30
A2012H-14P	26.00	28.30
A2012H-15P	28.00	30.30
A2012H-16P	20.00	32.30

Unit: mm

A2012WV

2.00mm pitch 180° Wafer

Reference Informations:

- *Material: Pin: Brass/Tin over Nickel
Insulator: Nylon 6T, UL94V-0
- *Mates with CJT A2012 series Housing
- *Color: Ivory

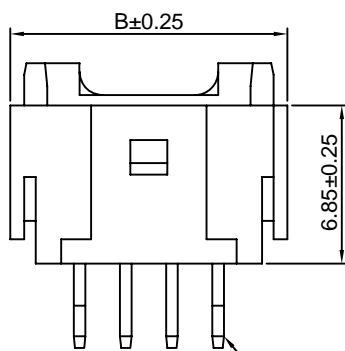
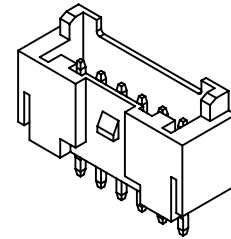
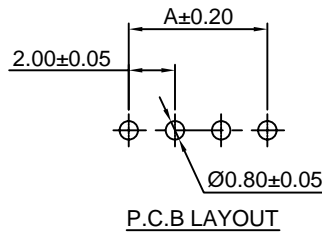
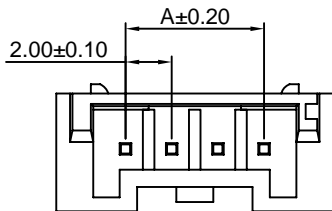

PIN 0.50 SQ
Circuit 1

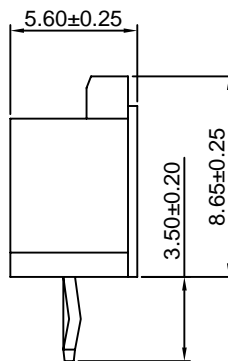

Ordering Information & Dimensions

PART NO.	Dimensions	
	A	B
A2012WV-2P	2.00	8.00
A2012WV-3P	4.00	10.00
A2012WV-4P	6.00	12.00
A2012WV-5P	8.00	14.00
A2012WV-6P	10.00	16.00
A2012WV-7P	12.00	18.00
A2012WV-8P	14.00	20.00
A2012WV-9P	16.00	22.00
A2012WV-10P	18.00	24.00
A2012WV-11P	20.00	26.00
A2012WV-12P	22.00	28.00
A2012WV-13P	24.00	30.00
A2012WV-14P	26.00	32.00
A2012WV-15P	28.00	34.00
A2012WV-16P	30.00	36.00

Unit: mm

A2012WR

2.00mm pitch 90° Wafer

Reference Informations:

- *Material: Pin: Brass/Tin over Nickel
Insulator: Nylon 6T, UL94V-0
- *Mates with CJT A2012 series Housing
- *Color: Ivory

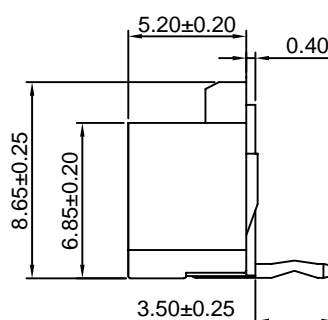
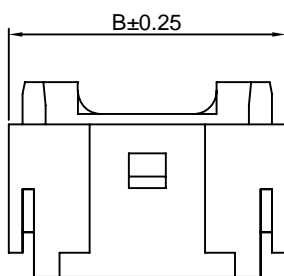
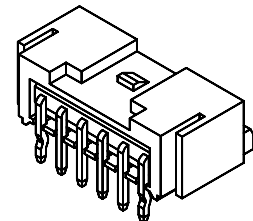
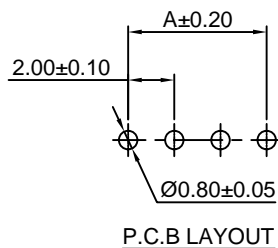
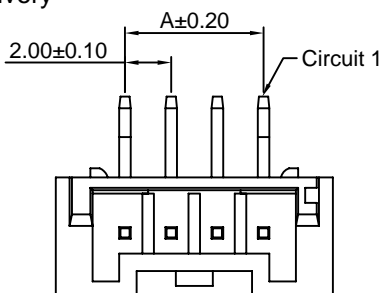

Ordering Information & Dimensions

PART NO.	Dimensions	
	A	B
A2012WR-2P	2.00	8.00
A2012WR-3P	4.00	10.00
A2012WR-4P	6.00	12.00
A2012WR-5P	8.00	14.00
A2012WR-6P	10.00	16.00
A2012WR-7P	12.00	18.00
A2012WR-8P	14.00	20.00
A2012WR-9P	16.00	22.00
A2012WR-10P	18.00	24.00
A2012WR-11P	20.00	26.00
A2012WR-12P	22.00	28.00
A2012WR-13P	24.00	30.00
A2012WR-14P	26.00	32.00
A2012WR-15P	28.00	34.00
A2012WR-16P	30.00	36.00

Unit: mm

A2012WV-S

2.00mm pitch 180° Wafer-SMT TYPE

Reference Informations:

- *Material:Pin:Brass/Tin over Nickel
Insulator:Nylon 6T,UL94V-0
- *Mates with CJT A2012 series Housing
- *Color:Ivory

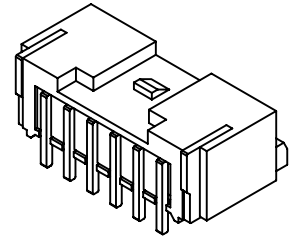
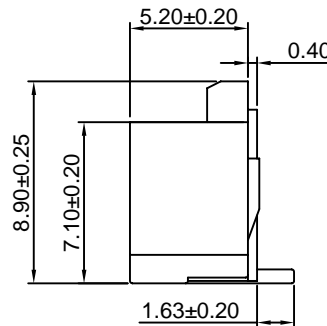
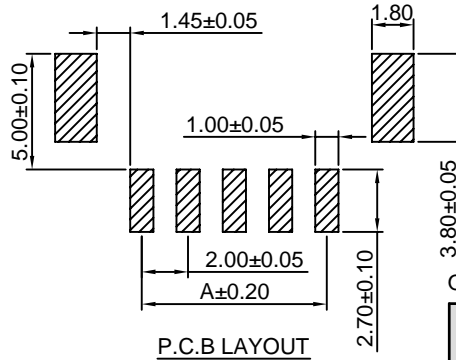
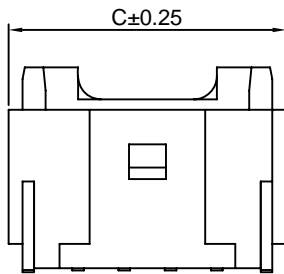

Ordering Information & Dimensions

PART NO.	Dimensions		
	A	B	C
A2012WV-S-2P	2.00	4.50	8.00
A2012WV-S-3P	4.00	6.50	10.00
A2012WV-S-4P	6.00	8.50	12.00
A2012WV-S-5P	8.00	10.50	14.00
A2012WV-S-6P	10.00	12.50	16.00
A2012WV-S-7P	12.00	14.50	18.00
A2012WV-S-8P	14.00	16.50	20.00
A2012WV-S-9P	16.00	18.50	22.00
A2012WV-S-10P	18.00	20.50	24.00
A2012WV-S-11P	20.00	22.50	26.00
A2012WV-S-12P	22.00	24.50	28.00
A2012WV-S-13P	24.00	26.50	30.00
A2012WV-S-14P	26.00	28.50	32.00
A2012WV-S-15P	28.00	30.50	34.00
A2012WV-S-16P	30.00	32.50	36.00

Unit: mm

A2012WR-S

2.00mm pitch 90° Wafer-SMT TYPE

Reference Informations:

- *Material:Pin:Brass/Tin over Nickel
Insulator:Nylon 6T,UL94V-0
- *Mates with CJT A2012 series Housing
- *Color:Ivory

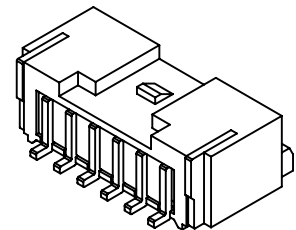
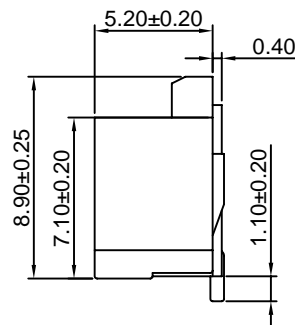
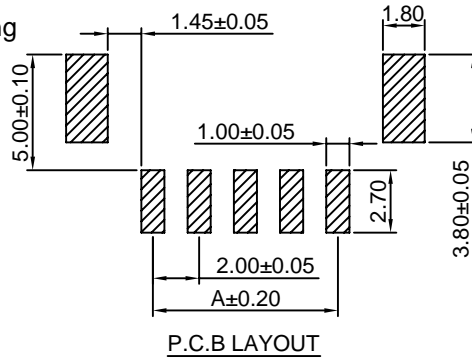
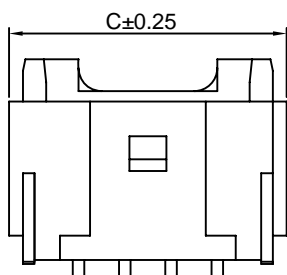
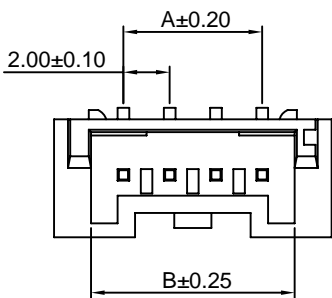

Ordering Information & Dimensions

PART NO.	Dimensions		
	A	B	C
A2012WR-S-2P	2.00	4.50	8.00
A2012WR-S-3P	4.00	6.50	10.00
A2012WR-S-4P	6.00	8.50	12.00
A2012WR-S-5P	8.00	10.50	14.00
A2012WR-S-6P	10.00	12.50	16.00
A2012WR-S-7P	12.00	14.50	18.00
A2012WR-S-8P	14.00	16.50	20.00
A2012WR-S-9P	16.00	18.50	22.00
A2012WR-S-10P	18.00	20.50	24.00
A2012WR-S-11P	20.00	22.50	26.00
A2012WR-S-12P	22.00	24.50	28.00
A2012WR-S-13P	24.00	26.50	30.00
A2012WR-S-14P	26.00	28.50	32.00
A2012WR-S-15P	28.00	30.50	34.00
A2012WR-S-16P	30.00	32.50	36.00

Unit: mm

A2012WVA

2.00mm pitch 180° Wafer

Reference Informations:

- *Material: Pin: Brass/Tin over Nickel
Insulator: Nylon 66, UL94V-0
- *Mates with CJT A2012 series Housing
- *Color: White

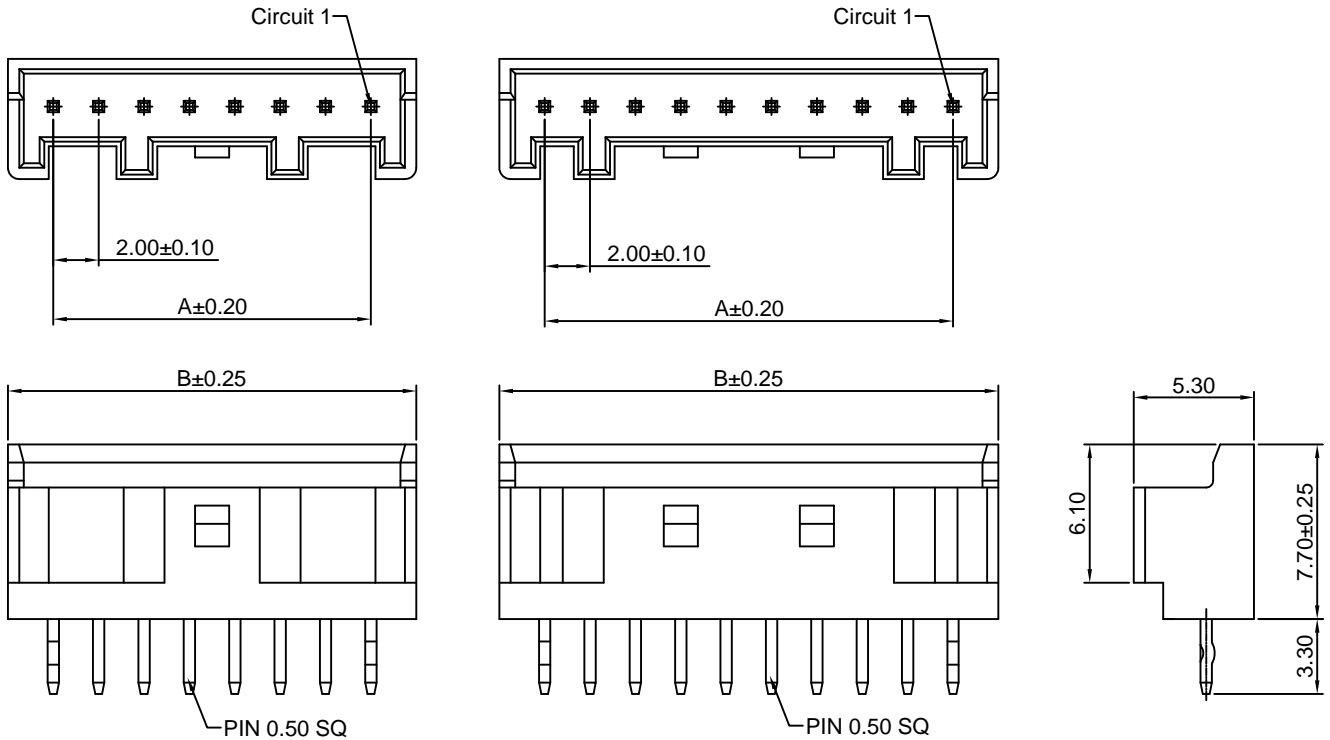

2P~9P

10P~15P

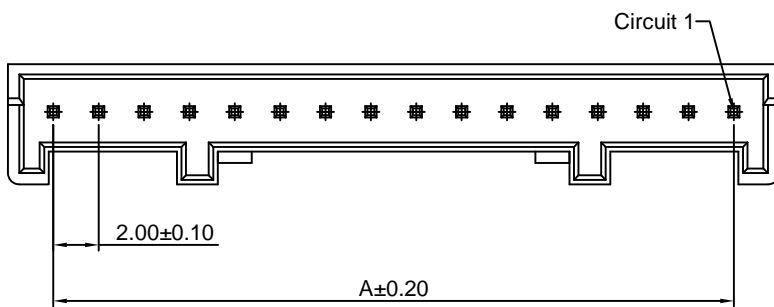

16P

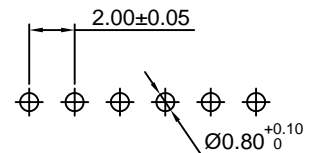

P.C.B LAYOUT

Ordering Information & Dimensions

PART NO.	Dimensions	
	A	B
A2012WVA-2P	2.00	6.00
A2012WVA-3P	4.00	8.00
A2012WVA-4P	6.00	10.00
A2012WVA-5P	8.00	12.00
A2012WVA-6P	10.00	14.00
A2012WVA-7P	12.00	16.00
A2012WVA-8P	14.00	18.00
A2012WVA-9P	16.00	20.00
A2012WVA-10P	18.00	22.00
A2012WVA-11P	20.00	24.00
A2012WVA-12P	22.00	26.00
A2012WVA-13P	24.00	28.00
A2012WVA-14P	26.00	30.00
A2012WVA-15P	28.00	32.00
A2012WVA-16P	30.00	34.00

Unit: mm

A2012WRA

2.00mm pitch 90° Wafer

Reference Informations:

- *Material: Pin: Brass/Tin over Nickel
Insulator: Nylon 66, UL94V-0
- *Mates with CJT A2012 series Housing
- *Color: White

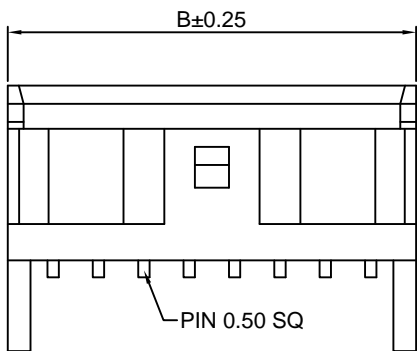
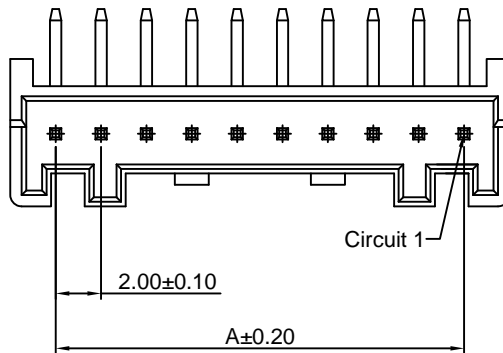
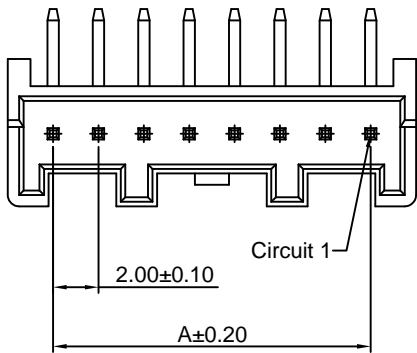

2P~9P

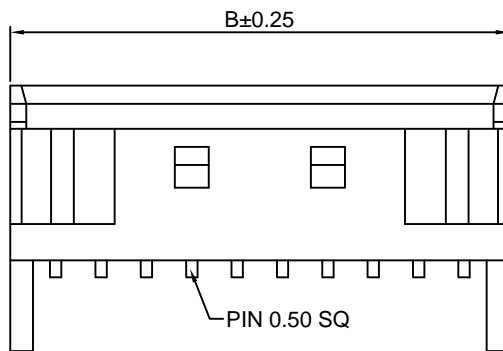

10P~15P

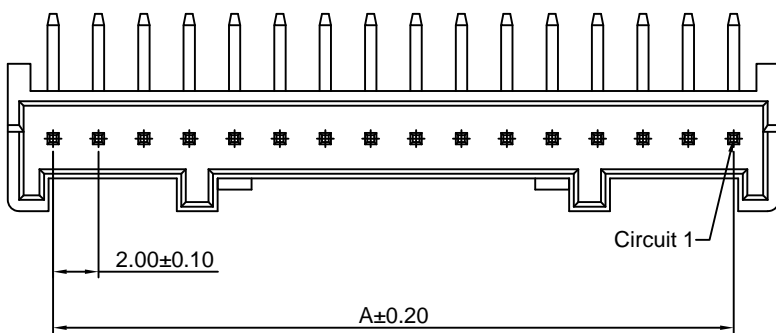
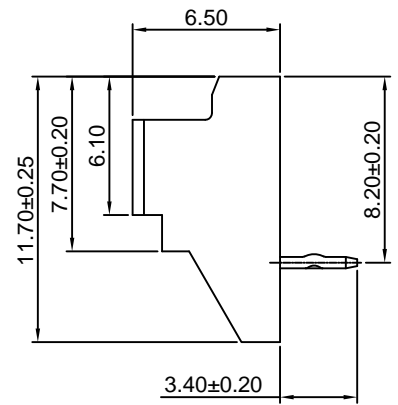

16P

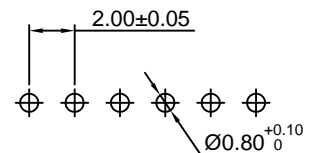
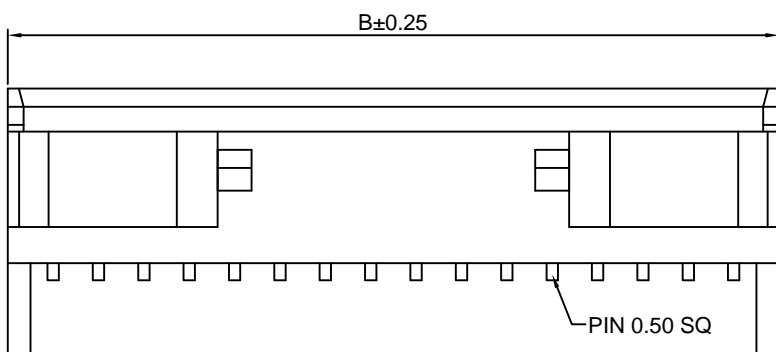

P.C.B LAYOUT

Ordering Information & Dimensions

PART NO.	Dimensions	
	A	B
A2012WRA-2P	2.00	6.00
A2012WRA-3P	4.00	8.00
A2012WRA-4P	6.00	10.00
A2012WRA-5P	8.00	12.00
A2012WRA-6P	10.00	14.00
A2012WRA-7P	12.00	16.00
A2012WRA-8P	14.00	18.00
A2012WRA-9P	16.00	20.00
A2012WRA-10P	18.00	22.00
A2012WRA-11P	20.00	24.00
A2012WRA-12P	22.00	26.00
A2012WRA-13P	24.00	28.00
A2012WRA-14P	26.00	30.00
A2012WRA-15P	28.00	32.00
A2012WRA-16P	30.00	34.00

Unit: mm

A2012WVA-F

2.00mm pitch 180° Wafer

Reference Informations:

- *Material: Pin: Brass/Tin over Nickel
Insulator: Nylon 66, UL94V-0
- *Mates with CJT A2012 series Housing
- *Color: White

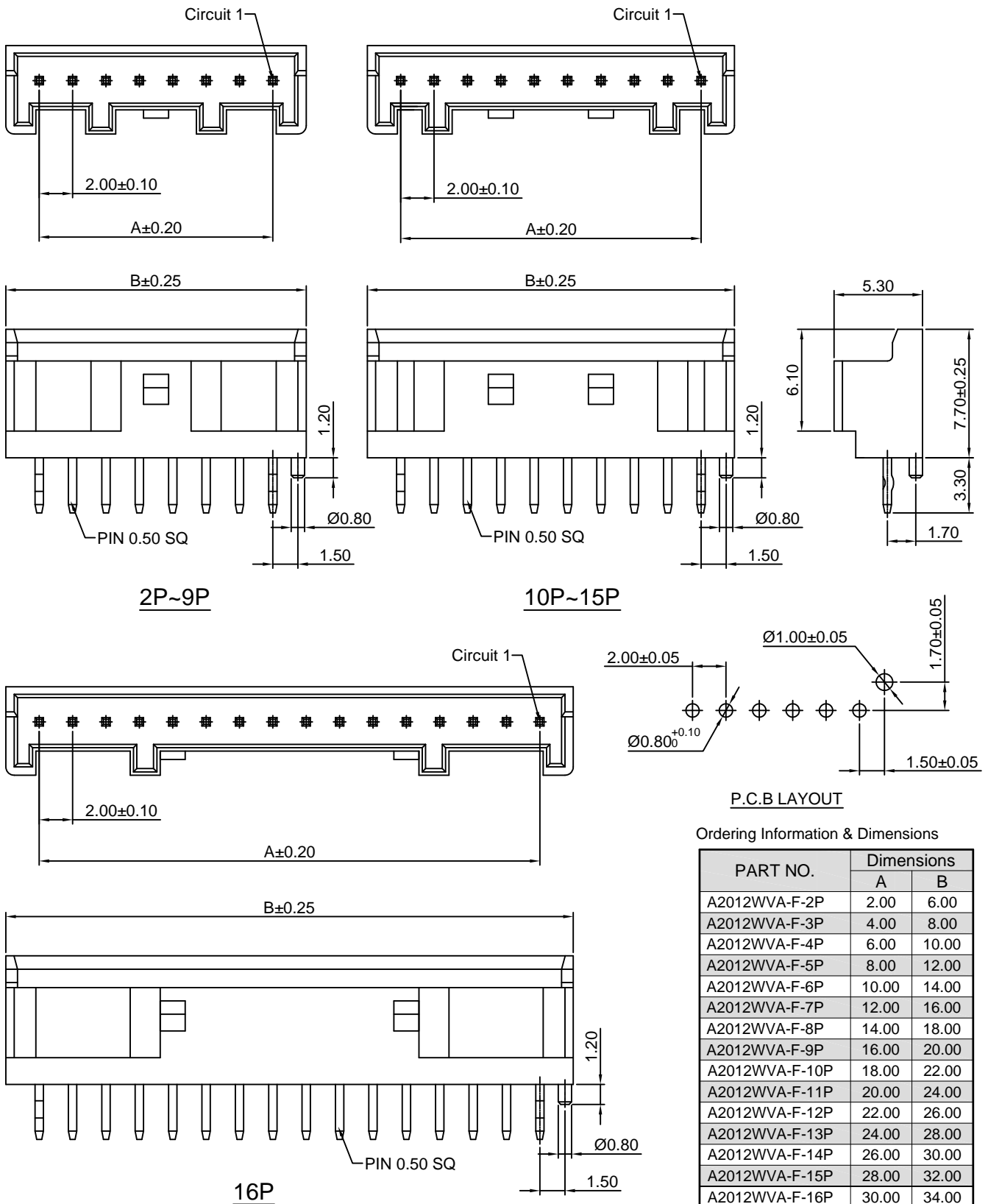

Ordering Information & Dimensions

PART NO.	Dimensions	
	A	B
A2012WVA-F-2P	2.00	6.00
A2012WVA-F-3P	4.00	8.00
A2012WVA-F-4P	6.00	10.00
A2012WVA-F-5P	8.00	12.00
A2012WVA-F-6P	10.00	14.00
A2012WVA-F-7P	12.00	16.00
A2012WVA-F-8P	14.00	18.00
A2012WVA-F-9P	16.00	20.00
A2012WVA-F-10P	18.00	22.00
A2012WVA-F-11P	20.00	24.00
A2012WVA-F-12P	22.00	26.00
A2012WVA-F-13P	24.00	28.00
A2012WVA-F-14P	26.00	30.00
A2012WVA-F-15P	28.00	32.00
A2012WVA-F-16P	30.00	34.00

Unit: mm

A2012WRA-F

2.00mm pitch 90° Wafer

Reference Informations:

- *Material: Pin: Brass/Tin over Nickel
Insulator: Nylon 66, UL94V-0
- *Mates with CJT A2012 series Housing
- *Color: White

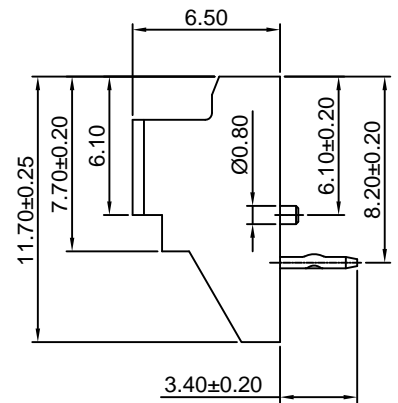
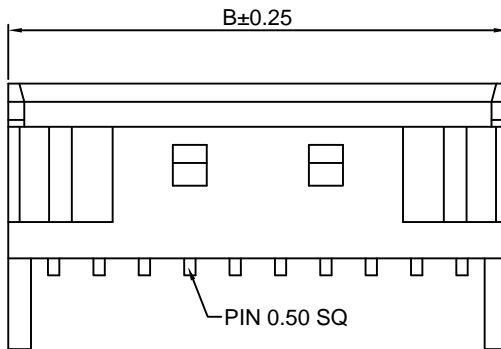
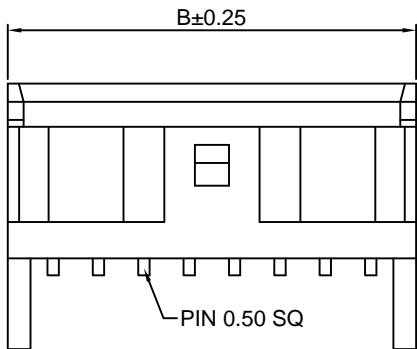
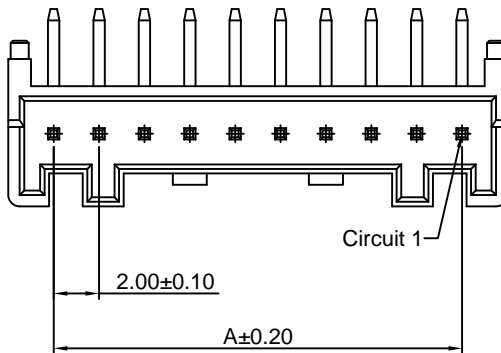
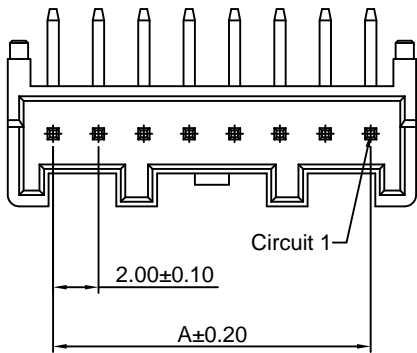

2P~9P

10P~15P

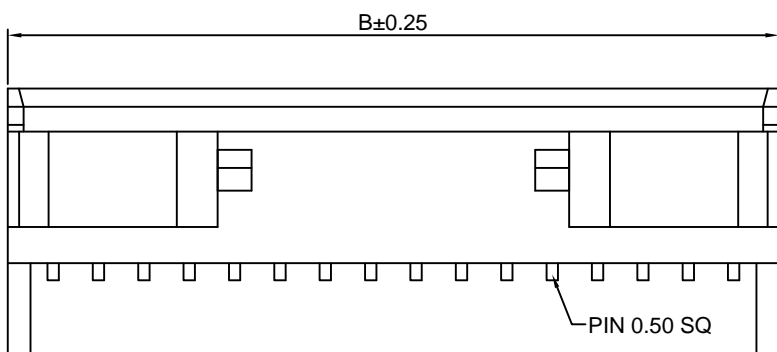
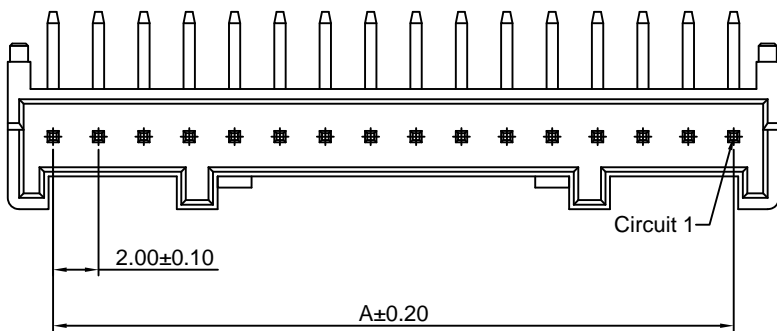

16P

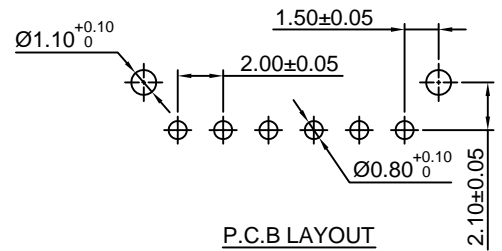

P.C.B LAYOUT

Ordering Information & Dimensions

PART NO.	Dimensions	
	A	B
A2012WRA-F-2P	2.00	6.00
A2012WRA-F-3P	4.00	8.00
A2012WRA-F-4P	6.00	10.00
A2012WRA-F-5P	8.00	12.00
A2012WRA-F-6P	10.00	14.00
A2012WRA-F-7P	12.00	16.00
A2012WRA-F-8P	14.00	18.00
A2012WRA-F-9P	16.00	20.00
A2012WRA-F-10P	18.00	22.00
A2012WRA-F-11P	20.00	24.00
A2012WRA-F-12P	22.00	26.00
A2012WRA-F-13P	24.00	28.00
A2012WRA-F-14P	26.00	30.00
A2012WRA-F-15P	28.00	32.00
A2012WRA-F-16P	30.00	34.00

Unit: mm

X-ON Electronics

Largest Supplier of Electrical and Electronic Components

Click to view similar products for [Headers & Wire Housings](#) category:

Click to view products by [Changjiang](#) manufacturer:

Other Similar products are found below :

[57102-F02-18ULF](#) [58102-G61-06LF](#) [0009485154](#) [009176003701906](#) [0050291907](#) [00-9021-0611-00-339](#) [02.125.8002.8](#) [609-3404](#) [61062-3](#)
[622-0430](#) [622-3653LF](#) [63453-116](#) [636-1030](#) [636-1427](#) [636-3427](#) [636-4007](#) [641938-9](#) [644827-2](#) [65495-038](#) [65692-001LF](#) [65781-018](#)
[65781-047](#) [65817-010LF](#) [65817-015LF](#) [66207-023LF](#) [67016-026LF](#) [67095-007LF](#) [68631-112](#) [68645-018](#) [68648-049](#) [699319-000](#)
[70.362.1628.0](#) [70-4210](#) [70-4226B](#) [70-4853B](#) [707-5020](#) [707-5028](#) [71.350.2428.0](#) [71961-016LF](#) [733-134](#) [754199-000](#) [760-3052](#) [787-8014-00](#)
[FCN-367T-T012/H](#) [80.063.4001.1](#) [800-90-001-10-001000](#) [800-90-010-10-002000](#) [801-43-002-10-013000](#) [801-43-006-10-002000](#)
[803-41-018-10-001000](#)