

Specifications

- Current rating:3A AC,DC
- Voltage rating:250V AC,DC
- Temperature range:-40°C~+105°C
- Contact resistance:10mΩMax.
- Insulation resistance:1000MΩMin.
- Withstanding voltage:800V AC/minute
- *Compliant with RoHS and REACH*
- *Meet the HF/Halogen Free,need to customize*
- *Contact CJT for details*

Standards

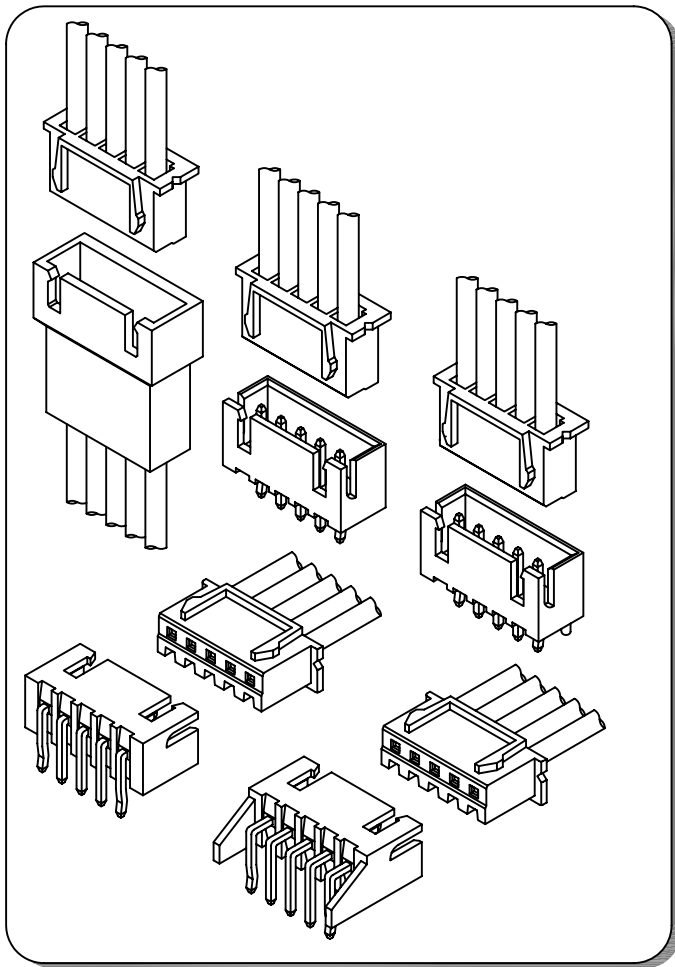

Assembly layout

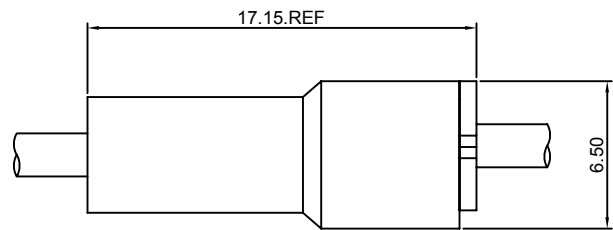

wire to wire

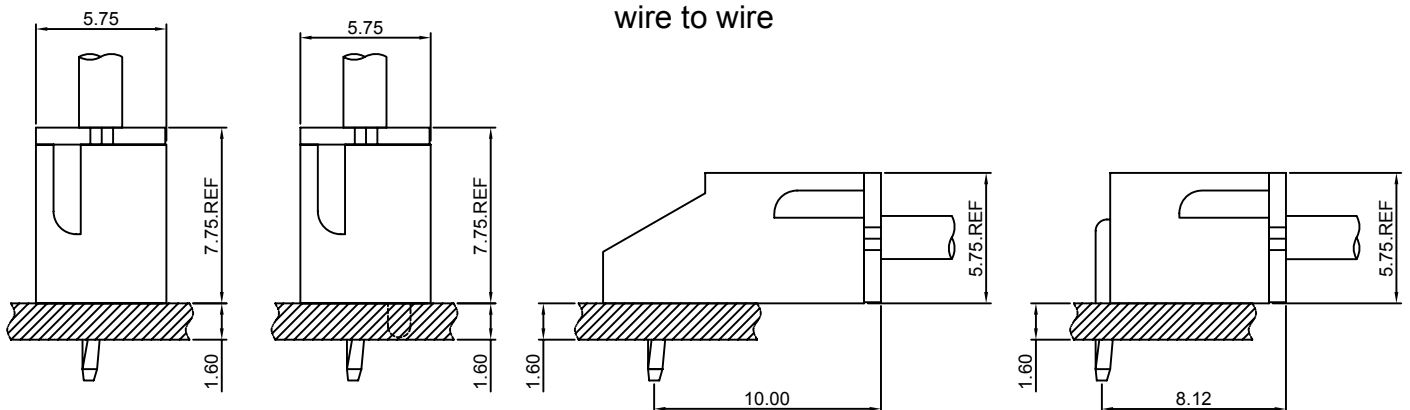

wire to board

A2501-T

2.50mm pitch Crimp Terminal

Reference Informations:

*Used in CJT A2501H,HB-XP,A2512H-XP series Housing

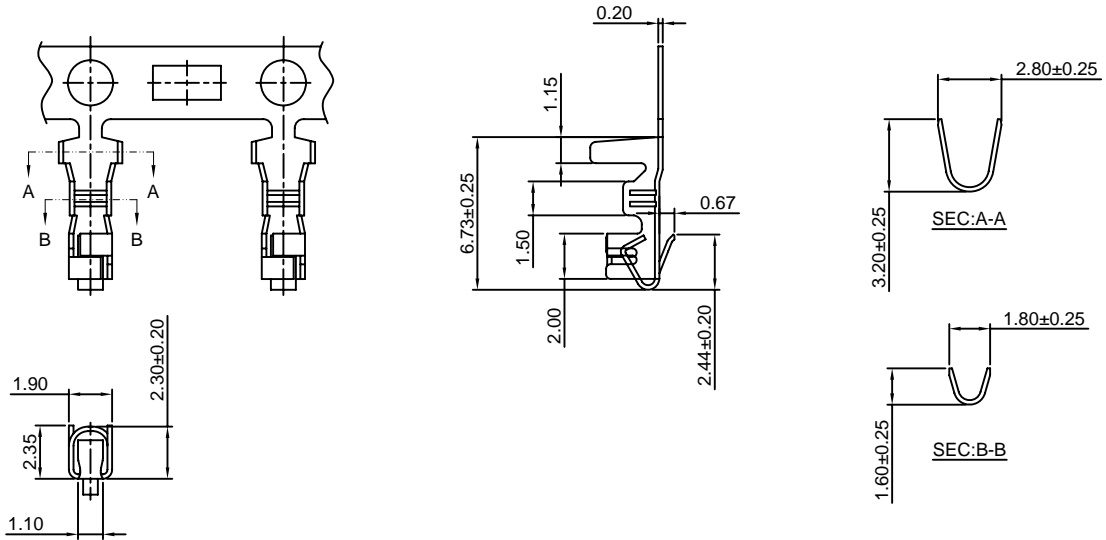

Ordering information & Specifications:

Unit:mm

Part NO.	Wire Range	Insulation O.D.	Material	Finish	Qty/reel
A2501-TP	AWG#22-#28	1.90mm(max)	Phosphor Bronze	Tin over Nickel	8,000 PCS
A2501-GP	AWG#22-#28	1.90mm(max)	Phosphor Bronze	Gold over Nickel	8,000 PCS

Optional Gold plating available but MOQ requested

A2501-T-A

2.50mm pitch Crimp Terminal

Reference Informations:

*Used in CJT A2501H,HB-XP,A2512H,HA,HB-XP series Housing

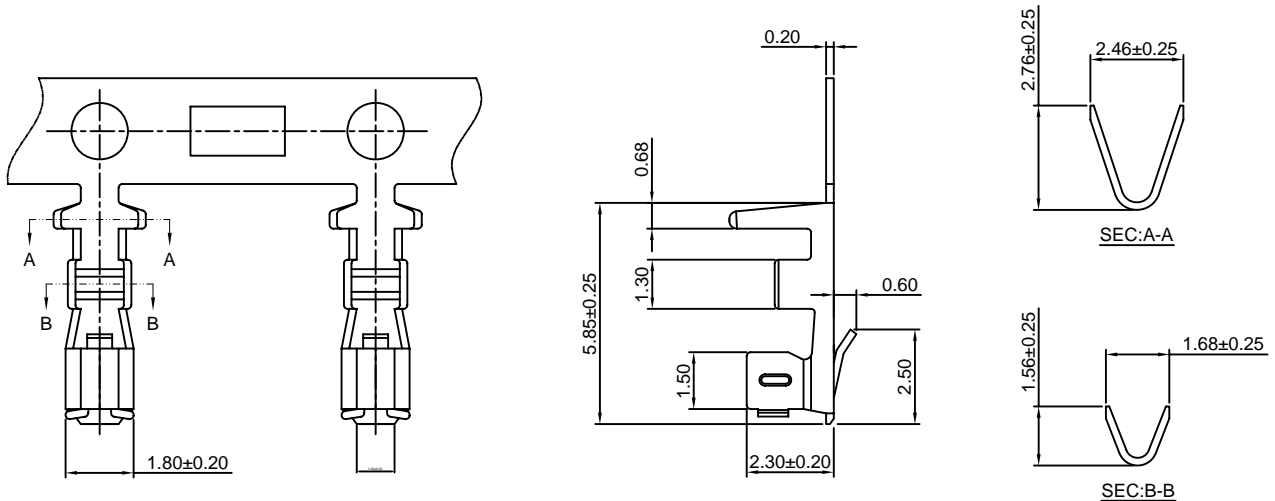

Ordering information & Specifications:

Unit:mm

Part NO.	Wire Range	Insulation O.D.	Material	Finish	Qty/reel
A2501-TP-A	AWG#22-#28	1.90mm(max)	Phosphor Bronze	Tin over Nickel	15,000 PCS
A2501-GP-A	AWG#22-#28	1.90mm(max)	Phosphor Bronze	Gold over Nickel	15,000 PCS

Optional Gold plating available but MOQ requested

A2501M-T

2.50mm pitch Crimp Terminal

Reference Informations:

*Used in CJT A2501HMB,HMC-XP,A2507HM-2P,A2509HM-XP,C2504HM,HMA-XP series Housing

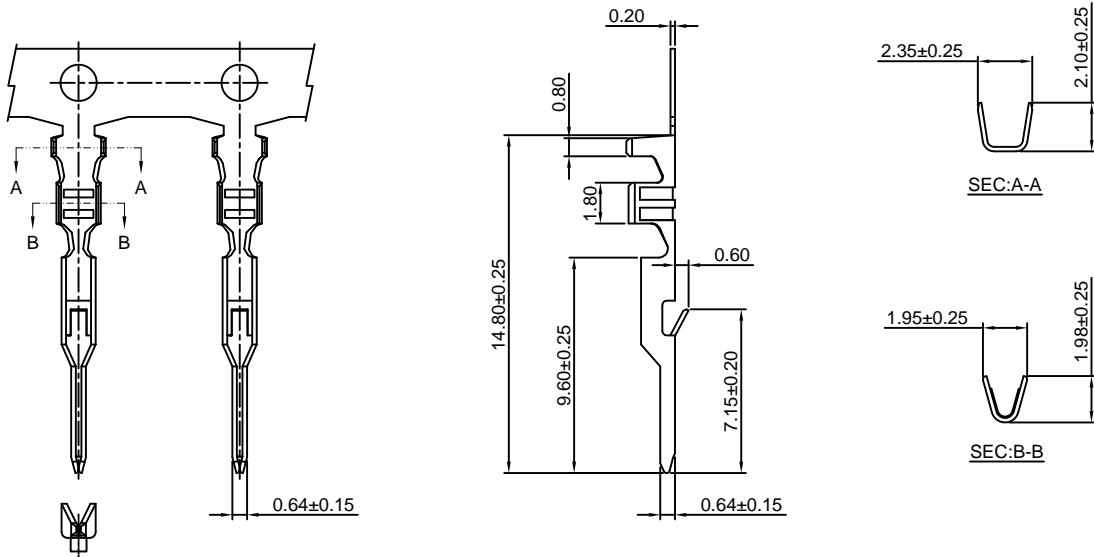

Ordering information & Specifications:

Unit:mm

Part NO.	Wire Range	Insulation O.D.	Material	Finish	Qty/reel
A2501M-TB	AWG#22-#28	1.00mm(max)	Brass	Tin over Nickel	10,000 PCS
A2501M-TP	AWG#22-#28	1.00mm(max)	Phosphor Bronze	Tin over Nickel	10,000 PCS
A2501M-GB	AWG#22-#28	1.00mm(max)	Brass	Gold over Nickel	10,000 PCS
A2501M-GP	AWG#22-#28	1.00mm(max)	Phosphor Bronze	Gold over Nickel	10,000 PCS

Optional Gold plating available but MOQ requested

A2501H-XP

2.50mm pitch Housing

Reference Informations:

*Material:Nylon 66,UL94V-0

*Suitable CJT A2501-T(-A) series Terminal

*Mates with CJT A2501HMB-XP series Housing or A2501WV(-F),WR,WV-S,WR-S-XP, A2501WRB,WVR,A2501WVC(-F)-XP,WVT-XP, A2512WVA,WRA,WVA-F,WVRA,WVT-XP series Wafer

*Color: White

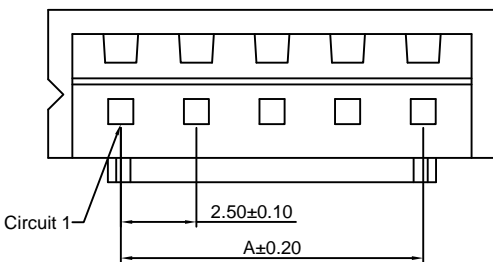
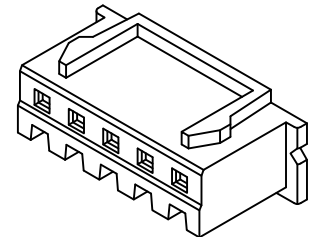

Ordering Information:

A2501H-XP - *** - **
1 2 3

1.Part No

2.Material:

(Blank):Nylon 66,UL94V-0

GWT:Nylon 66,UL94V-0,GWT 750 °C

3.Color:

(blank):White

BL:Blue

RD:Red

GN:Green

BR:Brown

VY:Vivid yellow

BK:Black

YL:Yellow

OR:Orange

LY:Lemon yellow

Ordering Information & Dimensions:

PART NO.	Dimensions	
	A	B
2P	2.50	5.70
3P	5.00	8.20
4P	7.50	10.70
5P	10.00	13.20
6P	12.50	15.70
7P	15.00	18.20
8P	17.50	20.70
9P	20.00	23.20
10P	22.50	25.70
11P	25.00	28.20
12P	27.50	30.70
13P	30.00	33.20
14P	32.50	35.70
15P	35.00	38.20
16P	37.50	40.70
17P	40.00	43.20
18P	42.50	45.70
19P	45.00	48.20
20P	47.50	50.70

Unit: mm

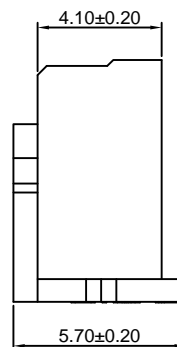
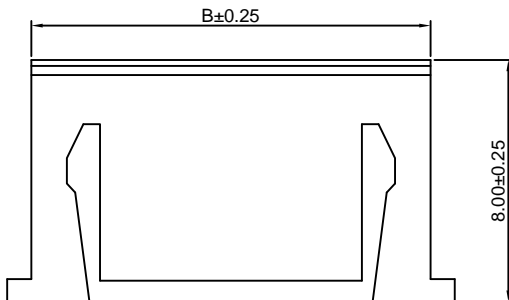

A2501HB-XP

2.50mm pitch Housing

Reference Informations:

- *Material:Nylon 66,UL94V-0
- *Suitable CJT A2501-T(-A) series Terminal
- *Mates with CJT A2501HMB-XP series Housing or A2501WV(-F),WR, WV-S,WR-S-XP,A2501WRB,WVR,A2501WVC(-F)-XPWVT-XP, series Wafer or A2512SA-XP series Retainer
- *Color: White

Ordering Information:

A2501HB-XP - *** - **
1 2 3

- 1.Part No.
- 2.Material:
(Blank):Nylon 66,UL94V-0
GWT:Nylon 66,UL94V-0,GWT 750 °C
- 3.Color:
(Blank):White
BL:Blue
BK:Black
RD:Red
YL:Yellow
GN:Green

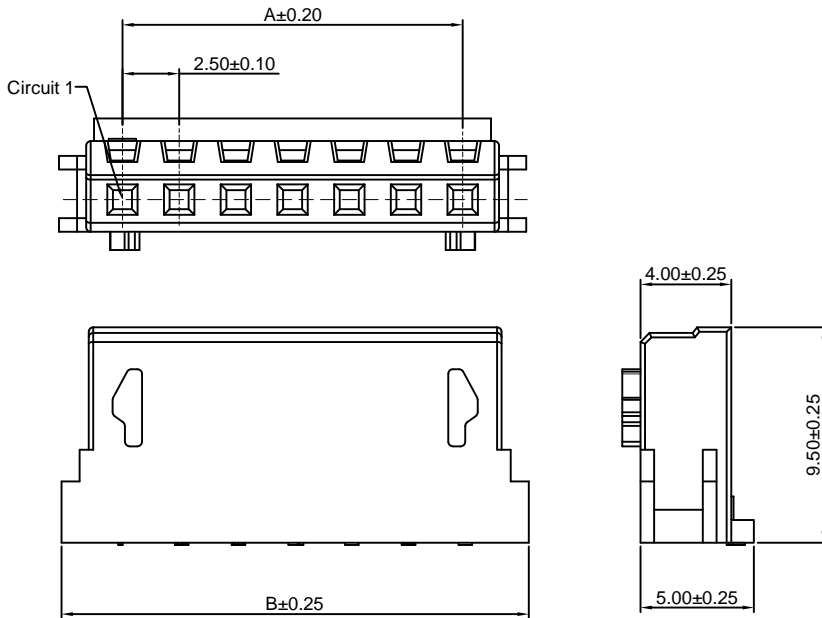

Ordering Information & Dimensions:

PART NO.	Dimensions	
	A	B
2P	2.50	8.10
3P	5.00	10.60
4P	7.50	13.10
5P	10.00	15.60
6P	12.50	18.10
7P	15.00	20.60
8P	17.50	23.10
9P	20.00	25.60
10P	22.50	28.10
11P	25.00	30.60
12P	27.50	33.10
13P	30.00	35.60
14P	32.50	38.10
15P	35.00	40.60

Unit: mm

A2501HMB-XP

2.50mm pitch Housing

Reference Informations:

- *Material:Nylon 66,UL94V-0
- *Suitable CJT A2501M-T series Terminal
- *Mates with CJT A2501H,HB-XP series Housing
- *Color:White

Ordering Information:

A2501HMB-XP - ** - ***
1 2 3

- 1.Part No.
- 2.Material:
(Blank):Nylon 66,UL94V-0
GWT:Nylon 66,UL94V-0,GWT 750 °C
- 3.Color:
(Blank):White
BL:Blue
BK:Black
RD:Red
YL:Yellow
GN:Green

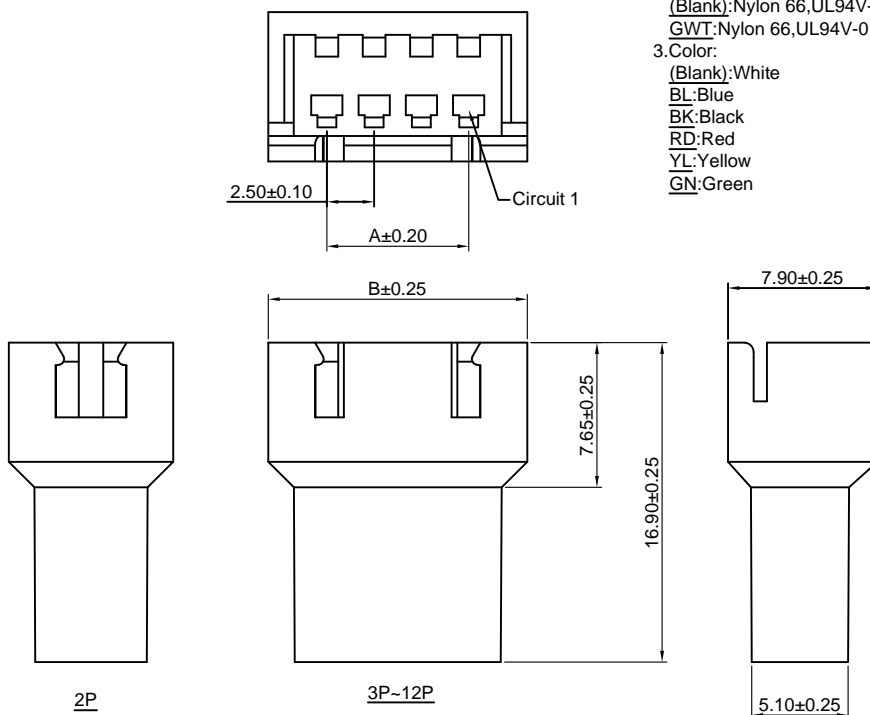

Ordering Information & Dimensions:

PART NO.	Dimensions	
	A	B
2P	2.50	8.70
3P	5.00	11.20
4P	7.50	13.70
5P	10.00	16.20
6P	12.50	18.70
7P	15.00	21.20
8P	17.50	23.70
9P	20.00	26.20
10P	22.50	28.70
11P	25.00	31.20
12P	27.50	33.70
13P	30.00	36.20
14P	32.50	38.70
15P	35.00	41.20
16P	37.50	43.70
17P	40.00	46.20
18P	42.50	48.70
19P	45.00	51.20
20P	47.50	53.70

Unit: mm

A2501HMC-XP

2.50mm pitch Housing

Reference Informations:

- *Material:Nylon 66,UL94V-0
- *Suitable CJT A2501M-T series Terminal
- *Mates with CJT A2512HA-XP series Housing
- *Color:White

Ordering Information:

A2501HMC-XP - ***
1 2

- Part No.
- Material:

(Blank):Nylon 66,UL94V-0
GWT:Nylon 66,UL94V-0,GWT 750 °C

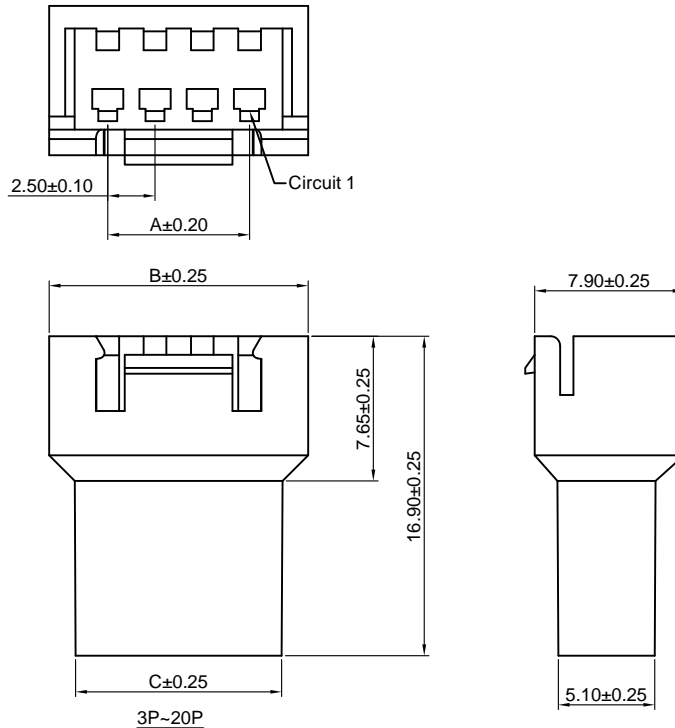

Ordering Information & Dimensions:

PART NO.	Dimensions		
	A	B	C
2P	2.50	8.70	5.90
3P	5.00	11.20	8.40
4P	7.50	13.70	10.90
5P	10.00	16.20	13.40
6P	12.50	18.70	15.90
7P	15.00	21.20	18.40
8P	17.50	23.70	20.90
9P	20.00	26.20	23.40
10P	22.50	28.70	25.90
11P	25.00	31.20	28.40
12P	27.50	33.70	30.90
13P	30.00	36.20	33.40
14P	32.50	38.70	35.90
15P	35.00	41.20	38.40
16P	37.50	43.70	40.90
17P	40.00	46.20	43.40
18P	42.50	48.70	45.90
19P	45.00	51.20	48.40
20P	47.50	53.70	50.90

Unit: mm

A2501WV(-F)-XP

2.50mm pitch 180° Wafer

Reference Informations:

- *Material:Pin:Brass/Tin over Nickel
Insulator:Nylon 66,UL94V-0
- *Mates with CJT A2501H,HB-XP series Housing
- *Color:White

Ordering Information:

A2501WV(-F)-XP - * - *** - ** - **
1 2 3 4 5

- Part No
- Style:
(blank) :Type 1
2 :Type 2
- Material:
(Blank):Nylon 66,UL94V-0
GWT:Nylon 66,UL94V-0,GWT 750 °C
- Color:
(blank):White
BL:Blue
RD:Red
GN:Green
BR:Brown
VY:Vivid yellow
BK:Black
YL:Yellow
OR:Orange
LY:Lemon yellow
- Finish:
(blank):Tin over Nickel
G:Gold over Nickel

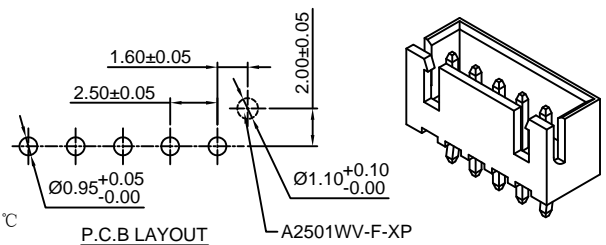

Ordering Information & Dimensions:

PART NO.	Dimensions	
	A	B
2P	2.50	7.50
3P	5.00	10.00
4P	7.50	12.50
5P	10.00	15.00
6P	12.50	17.50
7P	15.00	20.00
8P	17.50	22.50
9P	20.00	25.00
10P	22.50	27.50
11P	25.00	30.00
12P	27.50	32.50
13P	30.00	35.00
14P	32.50	37.50
15P	35.00	40.00
16P	37.50	42.50
17P	40.00	45.00
18P	42.50	47.50
19P	45.00	50.00
20P	47.50	52.50

Unit: mm

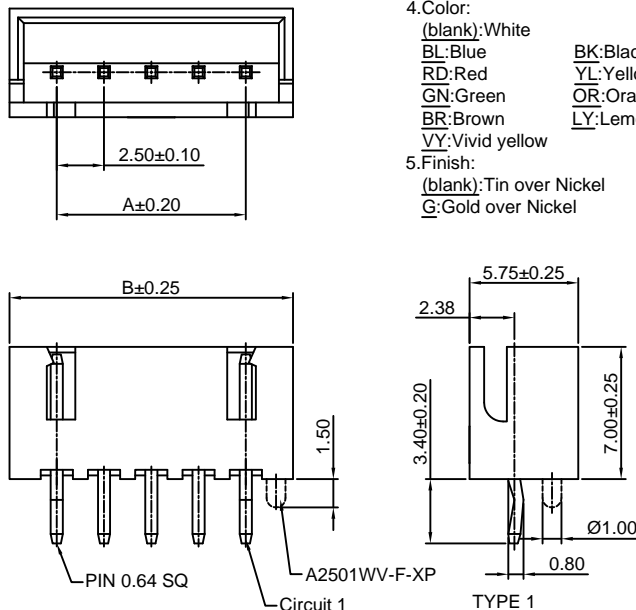

A2501WVC(-F)-XP

2.5mm pitch 180° Wafer

Reference Informations:

- *Material: Pin: Brass/Tin over Nickel
Insulator: Nylon 66, UL94V-0
- *Mates with CJT A2501H, HB-XP series Housing
- *Color: White

Ordering Information:

A2501WVC(-F)-XP - *** - ** - **
1 2 3 4

- Part No
- Material:
(Blank): Nylon 66, UL94V-0
GWT: Nylon 66, UL94V-0, GWT 750 °C
- Color:
(blank): White
BL: Blue
BK: Black
RD: Red
YL: Yellow
GN: Green
LY: Lemon yellow
- Finish:
(blank): Tin over Nickel
G: Gold over Nickel

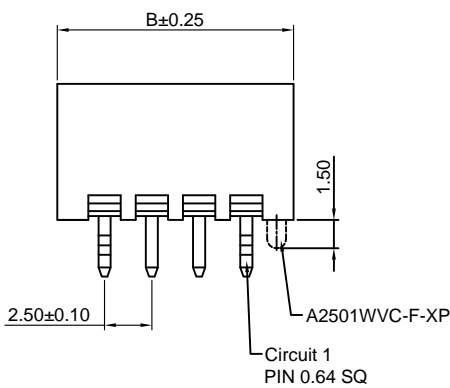
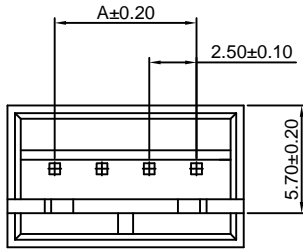
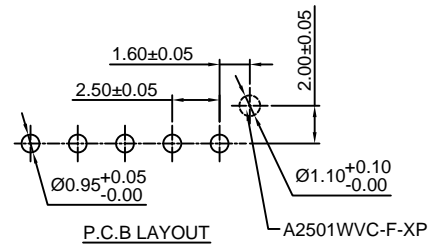

Ordering Information & Dimensions:

PART NO.	Dimensions	
	A	B
2P	2.50	7.50
3P	5.00	10.00
4P	7.50	12.50
5P	10.00	15.00
6P	12.50	17.50
7P	15.00	20.00
8P	17.50	22.50
9P	20.00	25.00
10P	22.50	27.50
11P	25.00	30.00
12P	27.50	32.50
13P	30.00	35.00
14P	32.50	37.50
15P	35.00	40.00
16P	37.50	42.50
17P	40.00	45.00
18P	42.50	47.50
19P	45.00	50.00
20P	47.50	52.50

Unit: mm

A2501WV-F-XP-H

2.5mm pitch 180° Wafer - With Boss

Reference Informations:

- *Material: Pin: Brass/Tin over Nickel
Insulator: Nylon 66, UL94V-0
- *Mates with CJT A2501H, HB-XP series Housing
- *Color: White

Ordering Information:

A2501WV-F-XP-H - *** - ** - **
1 2 3 4

- Part No
- Material:
(Blank): Nylon 66, UL94V-0
GWT: Nylon 66, UL94V-0, GWT 750 °C
- Color:
(blank): White
BL: Blue
BK: Black
RD: Red
YL: Yellow
GN: Green
- Finish:
(blank): Tin over Nickel
G: Gold over Nickel

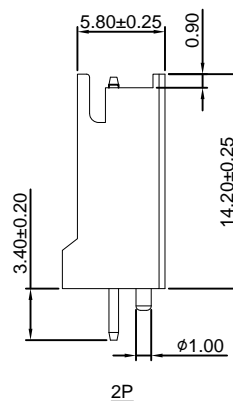
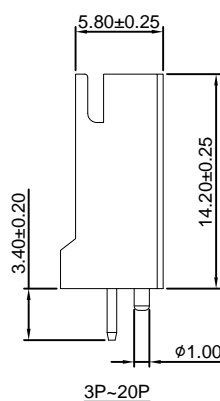
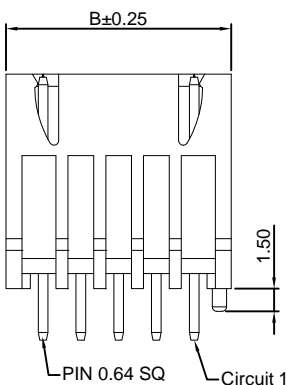
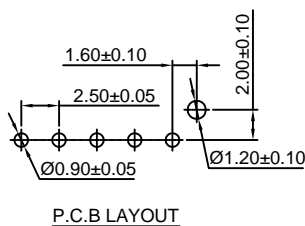
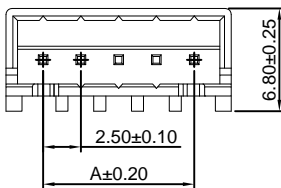
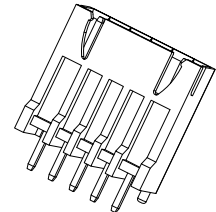

Ordering Information & Dimensions:

PART NO.	Dimensions	
	A	B
2P	2.50	7.50
3P	5.00	10.00
4P	7.50	12.50
5P	10.00	15.00
6P	12.50	17.50
7P	15.00	20.00
8P	17.50	22.50
9P	20.00	25.00
10P	22.50	27.50
11P	25.00	30.00
12P	27.50	32.50
13P	30.00	35.00
14P	32.50	37.50
15P	35.00	40.00
16P	37.50	42.50
17P	40.00	45.00
18P	42.50	47.50
19P	45.00	50.00
20P	47.50	52.50

Unit: mm

A2501WR-XP

—2.50mm pitch 90° Wafer

Reference Informations:

- *Material:Pin:Brass/Tin over Nickel
Insulator:Nylon 66,UL94V-0
- *Mates with CJT A2501H,HB-XP series Housing
- *Color:White

Ordering Information:

A2501WR-XP - ** - *** - ** - **
1 2 3 4 5

- 1.Part No
- 2.Style:
(blank) :Type 1
2 :Type 2
- 3.Material:
(Blank):Nylon 66,UL94V-0
GWT:Nylon 66,UL94V-0,GWT 750 °C
- 4.Color:
(blank):White
BL:Blue BK:Black
RD:Red YL:Yellow
GN:Green OR:Orange
BR:Brown LY:Lemon yellow
VY:Vivid yellow
- 5.Finish:
(blank):Tin over Nickel
G:Gold over Nickel

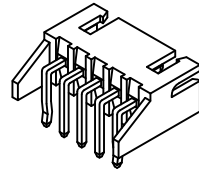
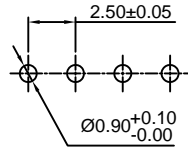

P.C.B LAYOUT

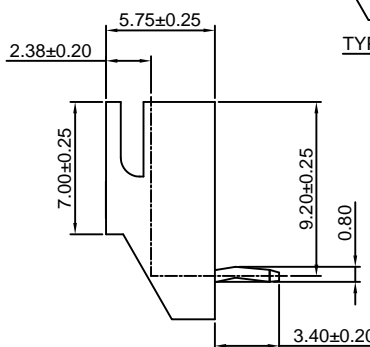
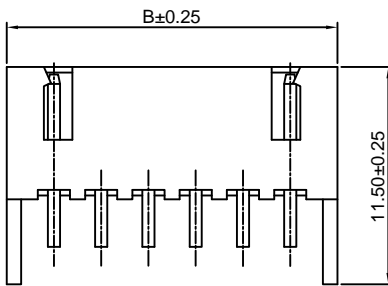
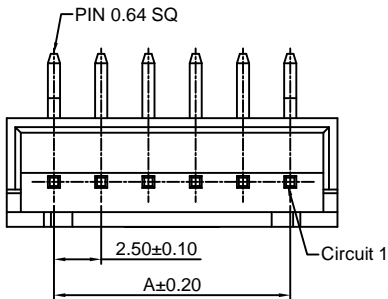

TYPE 1



TYPE 2

Ordering Information & Dimensions:

PART NO.	Dimensions	
	A	B
2P	2.50	7.50
3P	5.00	10.00
4P	7.50	12.50
5P	10.00	15.00
6P	12.50	17.50
7P	15.00	20.00
8P	17.50	22.50
9P	20.00	25.00
10P	22.50	27.50
11P	25.00	30.00
12P	27.50	32.50
13P	30.00	35.00
14P	32.50	37.50
15P	35.00	40.00
16P	37.50	42.50
17P	40.00	45.00
18P	42.50	47.50
19P	45.00	50.00
20P	47.50	52.50

Unit: mm

A2501WRB-XP

—2.50mm pitch 90° Wafer

Reference Informations:

- *Material:Pin:Brass/Tin over Nickel
Insulator:Nylon 66,UL94V-0
- *Mates with CJT A2501H,HB-XP series Housing
- *Color:White

Ordering Information:

A2501WRB-XP - ** - *** - ** - **
1 2 3 4 5

- 1.Part No
- 2.Style:
(blank) :Type 1
2 :Type 2
- 3.Material:
(Blank):Nylon 66,UL94V-0
GWT:Nylon 66,UL94V-0,GWT 750 °C
- 4.Color:
(blank):White
BL:Blue BK:Black
RD:Red YL:Yellow
GN:Green OR:Orange
BR:Brown LY:Lemon yellow
VY:Vivid yellow
- 5.Finish:
(blank):Tin over Nickel
G:Gold over Nickel

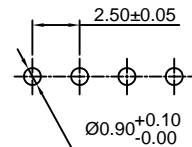

P.C.B LAYOUT

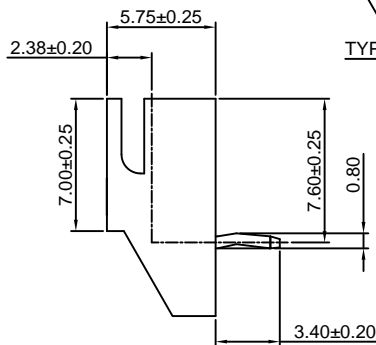
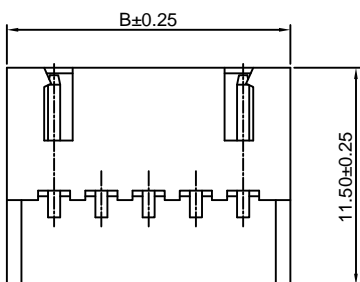
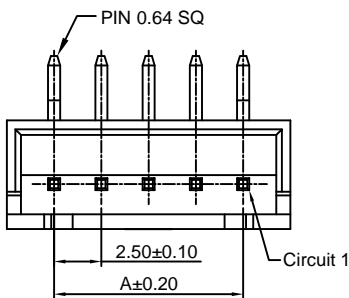

TYPE 1

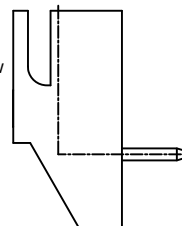

TYPE 2

Ordering Information & Dimensions:

PART NO.	Dimensions	
	A	B
2P	2.50	7.50
3P	5.00	10.00
4P	7.50	12.50
5P	10.00	15.00
6P	12.50	17.50
7P	15.00	20.00
8P	17.50	22.50
9P	20.00	25.00
10P	22.50	27.50
11P	25.00	30.00
12P	27.50	32.50
13P	30.00	35.00
14P	32.50	37.50
15P	35.00	40.00
16P	37.50	42.50
17P	40.00	45.00
18P	42.50	47.50
19P	45.00	50.00
20P	47.50	52.50

Unit: mm

A2501WVR-XP

2.50mm pitch 90° Wafer

Reference Informations:

- *Material:Pin:Brass/Tin over Nickel
Insulator:Nylon 66,UL94V-0
- *Mates with CJT A2501H,HB-XP series Housing
- *Color:White

Ordering Information:

A2501WVR-XP - ^{**} - ^{***} - ^{**} - ^{**}

1 2 3 4 5

- 1.Part No
- 2.Style:
(blank) :Type 1
2 :Type 2
- 3.Material:
(Blank):Nylon 66,UL94V-0
GWT:Nylon 66,UL94V-0,GWT 750 °C
- 4.Color:
(blank):White
BL:Blue
BK:Black
RD:Red
YL:Yellow
GN:Green
- 5.Finish:
(blank):Tin over Nickel
G:Gold over Nickel

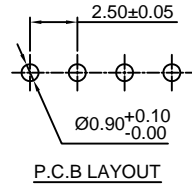
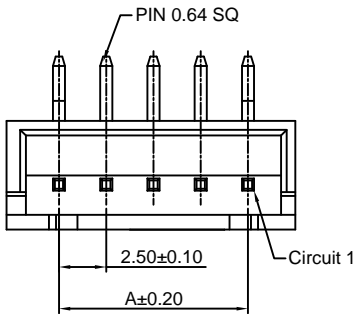
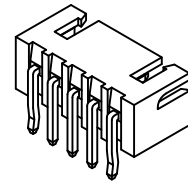

Ordering Information & Dimensions:

PART NO.	Dimensions	
	A	B
2P	2.50	7.50
3P	5.00	10.00
4P	7.50	12.50
5P	10.00	15.00
6P	12.50	17.50
7P	15.00	20.00
8P	17.50	22.50
9P	20.00	25.00
10P	22.50	27.50
11P	25.00	30.00
12P	27.50	32.50
13P	30.00	35.00
14P	32.50	37.50
15P	35.00	40.00
16P	37.50	42.50
17P	40.00	45.00
18P	42.50	47.50
19P	45.00	50.00
20P	47.50	52.50

Unit: mm

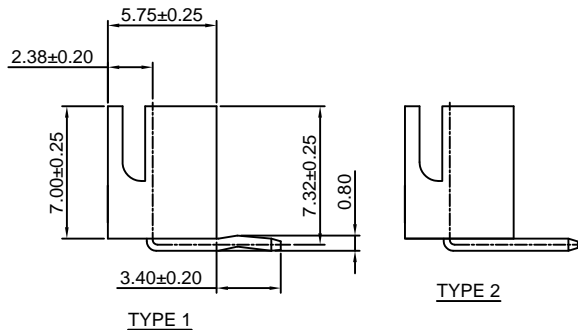
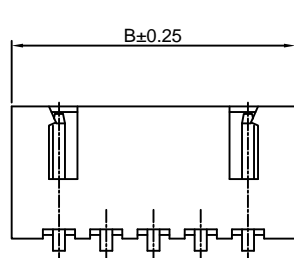

A2501WV-S-XP

2.50mm pitch 180° Wafer - SMT TYPE

Reference Informations:

- *Material:Pin:Brass/Tin over Nickel
Solder Tabs:Phosphor Bronze/Tin over Nickel
Insulator:LCP,UL94V-0
- *Mates with CJT A2501H,HB-XP series Housing
- *Color:Ivory

Ordering Information:

A2501WV-S-XP - ^{***} - ^{**} - ^{**}

1 2 3 4

- 1.Part No.
- 2.Material:
(Blank):LCP,UL94V-0
GWT:LCP,UL94V-0,GWT 750 °C
- 3.Color:
(blank):Ivory
BL:Blue
RD:Red
GN:Green
- 4.Finish:
(blank):Tin over Nickel
G:Gold over Nickel

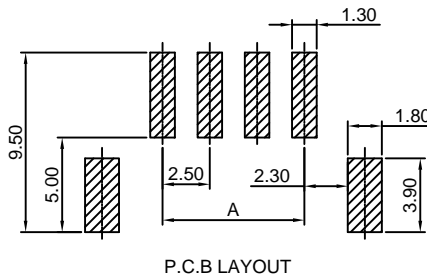
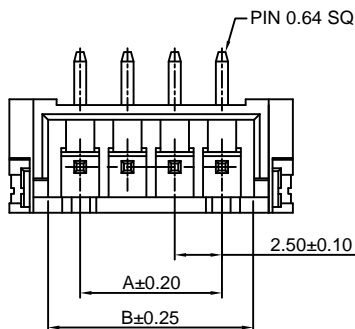

Ordering Information & Dimensions:

PART NO.	Dimensions		
	A	B	
2P	2.50	5.90	10.00
3P	5.00	8.40	12.50
4P	7.50	10.90	15.00
5P	10.00	13.40	17.50
6P	12.50	15.90	20.00
7P	15.00	18.40	22.50
8P	17.50	20.90	25.00
9P	20.00	23.40	27.50
10P	22.50	25.90	30.00
11P	25.00	28.40	32.50
12P	27.50	30.90	35.00
13P	30.00	33.40	37.50
14P	32.50	35.90	40.00
15P	35.00	38.40	42.50
16P	37.50	40.90	45.00

Unit: mm

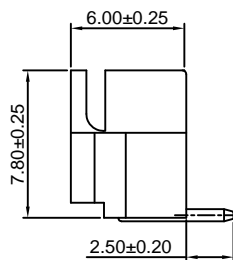
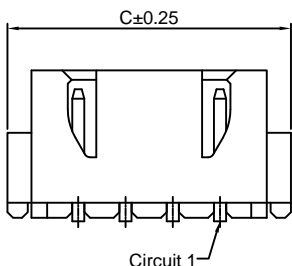

A2501WR-S-XP

2.50mm pitch 90° Wafer - SMT TYPE

Reference Informations:

- *Material:Pin:Brass/Tin over Nickel
Insulator:Nylon 6T,UL94V-0
- *Mates with CJT A2501H,HB-XP series Housing
- *Color:Ivory

- Ordering Information:
A2501WR-S-XP - *** - ** - **
1 2 3 4
- 1.Part No.
 - 2.Material:
(Blank):Nylon 6T,UL94V-0
GWT:Nylon 6T,UL94V-0,GWT 750°C
 - 3.Color:
(blank):Ivory
BL:Blue RD:Red
GN:Green LY:Lemon yellow
 - 4.Finish:
(blank):Tin over Nickel
G:Gold over Nickel

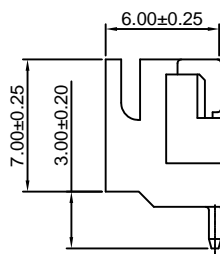
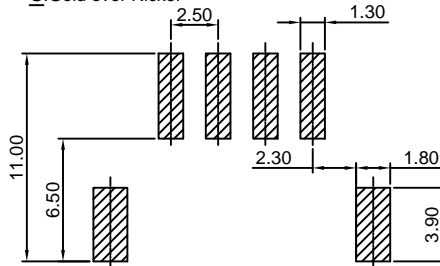
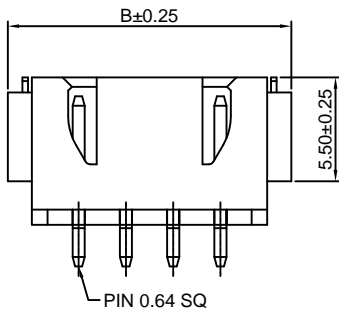
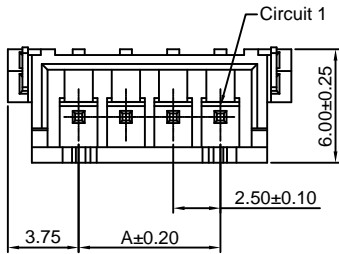
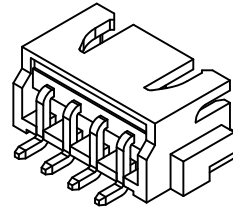

Ordering Information & Dimensions:

PART NO.	Dimensions	
	A	B
2P	2.50	10.00
3P	5.00	12.50
4P	7.50	15.00
5P	10.00	17.50
6P	12.50	20.00
7P	15.00	22.50
8P	17.50	25.00
9P	20.00	27.50
10P	22.50	30.00
11P	25.00	32.50
12P	27.50	35.00
13P	30.00	37.50
14P	32.50	40.00
15P	35.00	42.50
16P	37.50	45.00
17P	40.00	47.50
18P	42.50	50.00
19P	45.00	52.50
20P	47.50	55.00

Unit: mm

A2501WRA-S-F-2P

2.50mm pitch 90° Wafer - SMT TYPE

Reference Informations:

- *Material:Pin:Copper Alloy/Tin over Nickel
Insulator:Nylon 9T,UL94V-0
- *Color:Ivory

- Ordering Information:
A2501WRA-S-F-2P - *** - **
1 2 3
- 1.Part No.
 - 2.Material:
(Blank):Nylon 9T,UL94V-0
GWT:Nylon 9T,UL94V-0,GWT 750°C
 - 3.Finish:
(blank):Tin over Nickel
G:Gold over Nickel

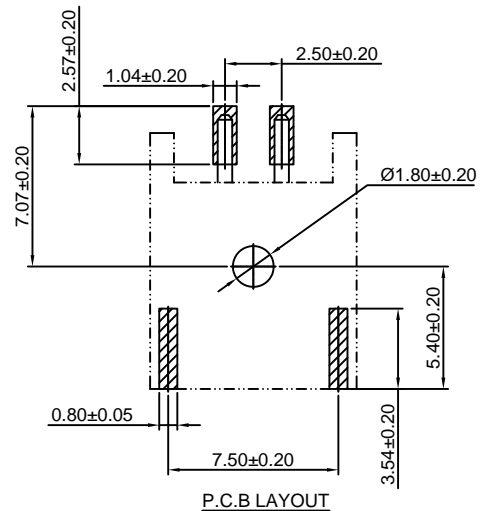
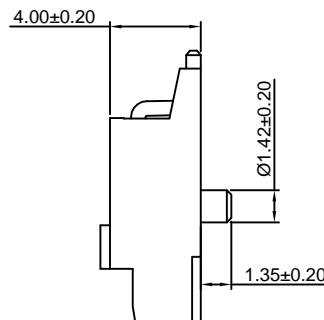
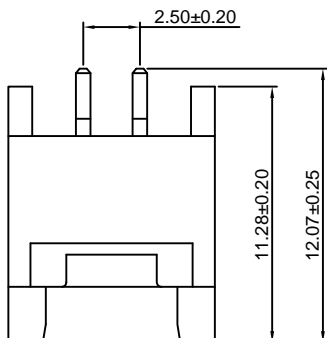
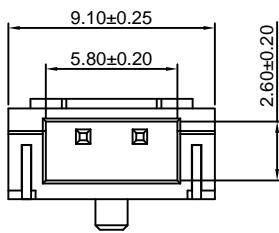

Unit: mm

A2501WVT-XP

2.5mm pitch 180° Wafer ON RADIAL-TAPE

Reference Informations:

- *Material: Pin: Brass/Tin over Nickel
Insulator: Nylon66, UL94V-0
- *Mates with CJT A2501H, HB-XP series Housing
- *Color: White

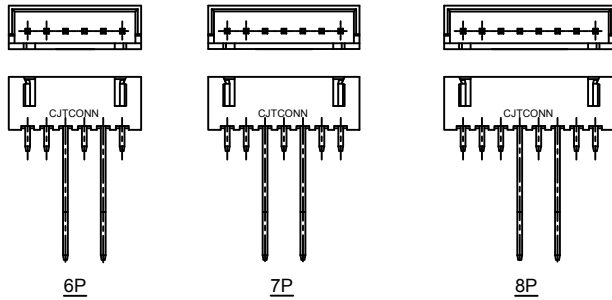
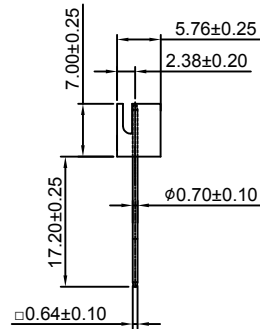
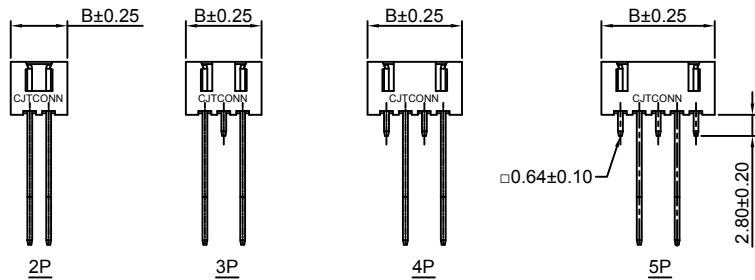
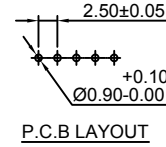
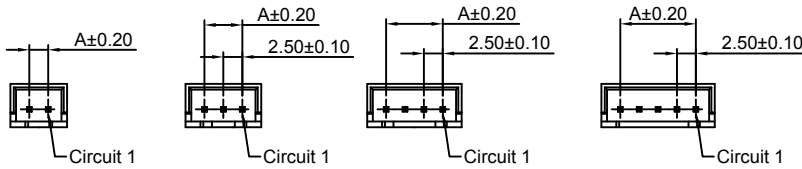
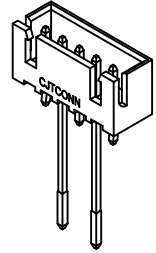

Ordering Information:

A2501WVT-XP - *** - ** - **
1 2 3 4

- Part No
- Material:
(Blank): Nylon 66, UL94V-0
GWT: Nylon 66, UL94V-0, GWT 750 °C
- Color:
(blank): White
BL: Blue BK: Black
RD: Red YL: Yellow
GN: Green
- Finish:
(blank): Tin over Nickel
G: Gold over Nickel

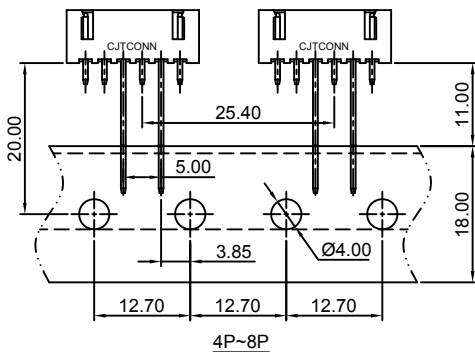
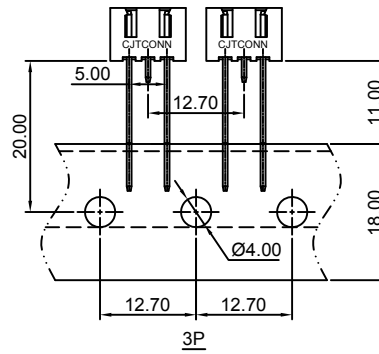
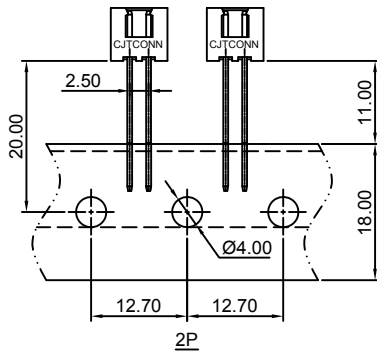

Ordering Information & Dimensions:

PART NO.	Dimensions	
	A	B
2P	2.50	7.50
3P	5.00	10.00
4P	7.50	12.50
5P	10.00	15.00
6P	12.50	17.50
7P	15.00	20.00
8P	17.50	22.50

Unit: mm

A2501HWV-XP

2.50mm pitch 180° Wafer

Reference Informations:

- *Material:Pin:Phosphor Bronze/Tin over Nickel
Insulator:Nylon 66,UL94V-0
- *Mates with CJT A2501HMB-XP series Housing or A2501WV,WR, WV-S,WR-S,WV-F-XP,A2501WRB,WVR,WVT-XP series Wafer
- *Color:White

Ordering Information:

A2501HWV-XP - *** - **
1 2 3

- 1.Part No.
- 2.Material:
(Blank):Nylon 66,UL94V-0
GWT:Nylon 66,UL94V-0,GWT 750 °C
- 3.Finish:
(blank):Tin over Nickel
G:Gold over Nickel

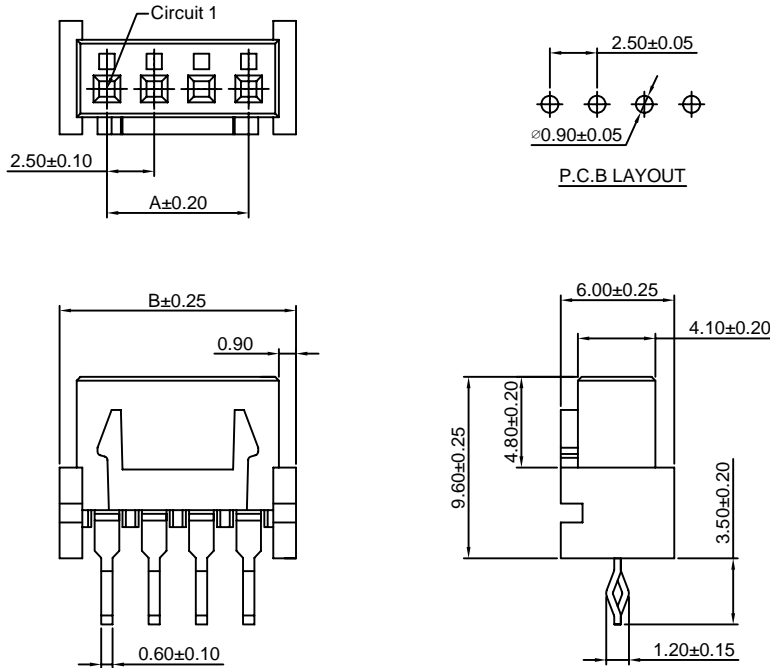

Ordering Information & Dimensions:

PART NO.	Dimensions	
	A	B
2P	2.50	7.50
3P	5.00	10.00
4P	7.50	12.50
5P	10.00	15.00
6P	12.50	17.50
7P	15.00	20.00
8P	17.50	22.50
9P	20.00	25.00
10P	22.50	27.50
11P	25.00	30.00
12P	27.50	32.50
13P	30.00	35.00
14P	32.50	37.50
15P	35.00	40.00
16P	37.50	42.50
17P	40.00	45.00
18P	42.50	47.50
19P	45.00	50.00
20P	47.50	52.50

Unit: mm

A2501HWR-XP

2.50mm pitch 90° Wafer

Reference Informations:

- *Material:Pin:Phosphor Bronze/Tin over Nickel
Insulator:Nylon 66,UL94V-0
- *Mates with CJT A2501HMB-XP series Housing or A2501WV,WR, WV-S,WR-S,WV-F-XP,A2501WRB,WVR,WVT-XP series Wafer
- *Color:White

Ordering Information:

A2501HWR-XP - *** - **
1 2 3

- 1.Part No.
- 2.Material:
(Blank):Nylon 66,UL94V-0
GWT:Nylon 66,UL94V-0,GWT 750 °C
- 3.Finish:
(blank):Tin over Nickel
G:Gold over Nickel

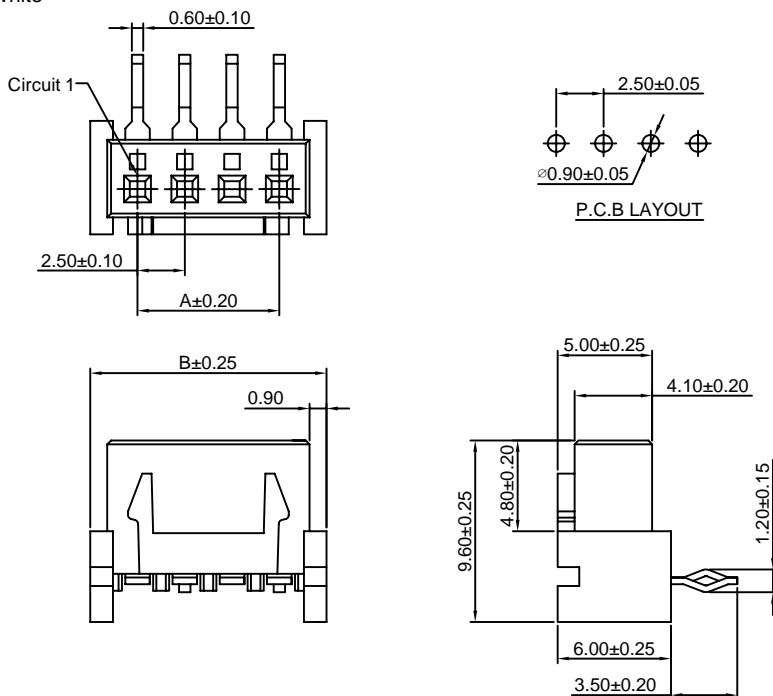

Ordering Information & Dimensions:

PART NO.	Dimensions	
	A	B
2P	2.50	7.50
3P	5.00	10.00
4P	7.50	12.50
5P	10.00	15.00
6P	12.50	17.50
7P	15.00	20.00
8P	17.50	22.50
9P	20.00	25.00
10P	22.50	27.50
11P	25.00	30.00
12P	27.50	32.50
13P	30.00	35.00
14P	32.50	37.50
15P	35.00	40.00
16P	37.50	42.50
17P	40.00	45.00
18P	42.50	47.50
19P	45.00	50.00
20P	47.50	52.50

Unit: mm

X-ON Electronics

Largest Supplier of Electrical and Electronic Components

Click to view similar products for [Headers & Wire Housings](#) category:

Click to view products by [Changjiang](#) manufacturer:

Other Similar products are found below :

[57102-F02-18ULF](#) [58102-G61-06LF](#) [0009485154](#) [009176003701906](#) [0050291907](#) [00-9021-0611-00-339](#) [02.125.8002.8](#) [609-3404](#) [61062-3](#)
[622-0430](#) [622-3653LF](#) [63453-116](#) [636-1030](#) [636-1427](#) [636-3427](#) [636-4007](#) [641938-9](#) [644827-2](#) [65495-038](#) [65692-001LF](#) [65781-018](#)
[65781-047](#) [65817-010LF](#) [65817-015LF](#) [66207-023LF](#) [67016-026LF](#) [67095-007LF](#) [68631-112](#) [68645-018](#) [68648-049](#) [699319-000](#)
[70.362.1628.0](#) [70-4210](#) [70-4226B](#) [70-4853B](#) [707-5020](#) [707-5028](#) [71.350.2428.0](#) [71961-016LF](#) [733-134](#) [754199-000](#) [760-3052](#) [787-8014-00](#)
[FCN-367T-T012/H](#) [80.063.4001.1](#) [800-90-001-10-001000](#) [800-90-010-10-002000](#) [801-43-002-10-013000](#) [801-43-006-10-002000](#)
[803-41-018-10-001000](#)