

## Specifications

- Current rating:3A AC,DC
- Voltage rating:250V AC,DC
- Temperature range:-40°C~+105°C
- Contact resistance:10mΩMax.
- Insulation resistance:1000MΩMin.
- Withstanding voltage:800V AC/minute
- \*Compliant with RoHS and REACH\*
- \*Meet the HF/Halogen Free,need to customize\*
- \*Contact CJT for details\*

## Standards



## Assembly layout

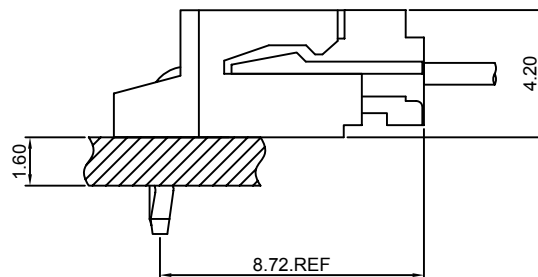
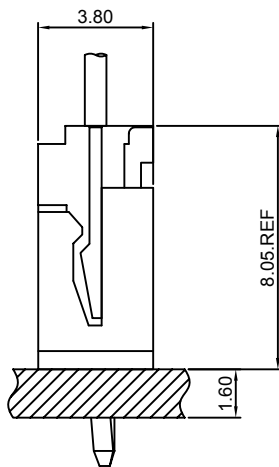

# A2502-T

2.50mm pitch Crimp Terminal

#### Reference Informations:

\*Used in CJT A2502H-XP, A2511H-XP series Housing

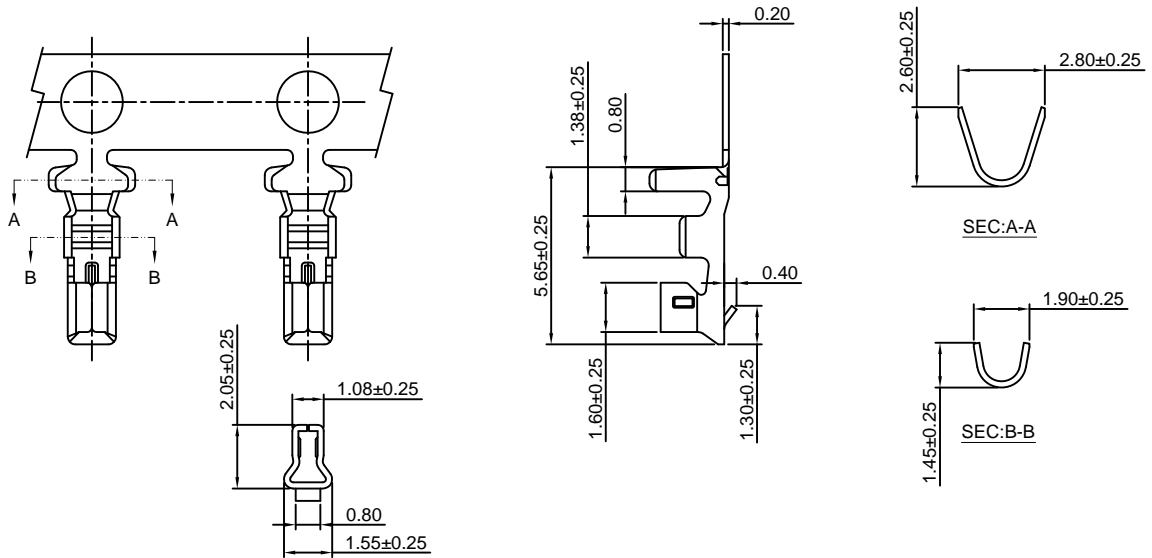

#### Ordering information & Specifications

Unit:mm

Part NO.	Wire Range	Insulation O.D.	Material	Finish	Qty/reel
A2502-TP	AWG#22-#30	1.90mm(max)	Phosphor Bronze	Tin over Nickel	10,000 PCS
A2502-GP	AWG#22-#30	1.90mm(max)	Phosphor Bronze	Gold over Nickel	10,000 PCS

Optional Gold plating available but MOQ requested

# A2502H-XP

2.50mm pitch Housing

#### Reference Informations:

\*Material:Nylon 66,UL94V-0

\*Suitable CJT A2502-T series Terminal

\*Mates with CJT A2502WV,WR-XP series Wafer

\*Color:White

#### Ordering Information:

A2502H-XP - \*\*\* - \*\*  
1 2 3

1.Part No.

2.Material:

(Blank):Nylon 66,UL94V-0

GWT:Nylon 66,UL94V-0,GWT 750°C

3.Color:

(Blank):White

RD:Red

YL:Yellow

BL:Blue

BK:Black

GN:Green

TR:Tomato red

LE:Light blue

OR:Orange

GY:Gray

PK:Pink

BR:Brown

VI:Violet

LY:Lemon yellow

VY:Vivid yellow

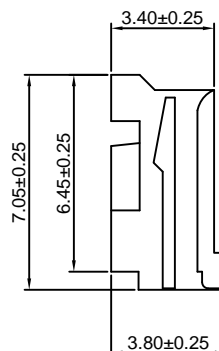
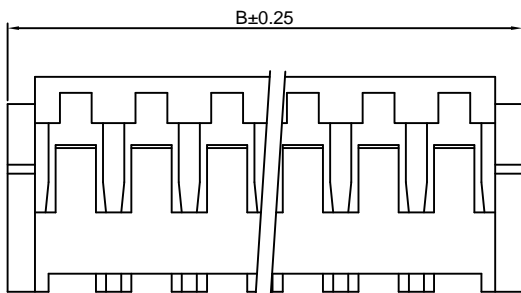
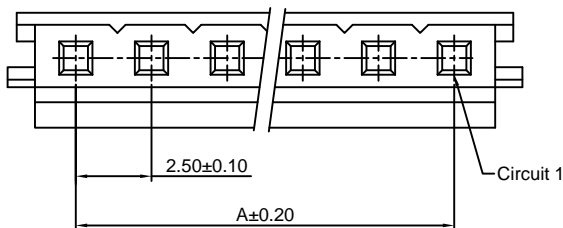
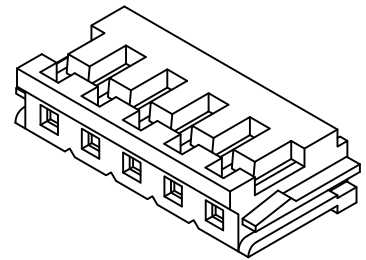

#### Ordering Information & Dimensions

PART NO.	Dimensions	
	A	B
2P	2.50	7.00
3P	5.00	9.50
4P	7.50	12.00
5P	10.00	14.50
6P	12.50	17.00
7P	15.00	19.50
8P	17.50	22.00
9P	20.00	24.50
10P	22.50	27.00
11P	25.00	29.50
12P	27.50	32.00
13P	30.00	34.50
14P	32.50	37.00
15P	35.00	39.50

Unit: mm

### A2502HWV-XP

2.50mm pitch Housing

**Reference Informations:**

- \*Material:Pin:Phosphor Bronze/Tin over Nickel  
Insulator:PBT,UL94V-0
- \*Mates with CJT A2502WVA,WRA-XP,A2502WVB,WRB-XP,  
A2502WVA-N,WRA-N-XP,A2502WVB-N,WRB-N-XP series Wafer
- \*Color:Gray

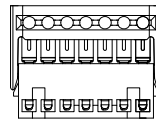
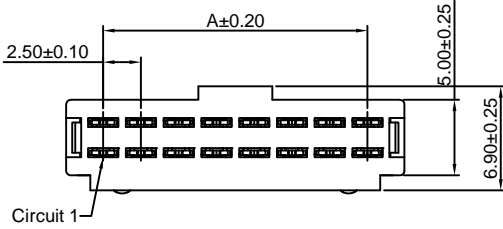

2P~7P

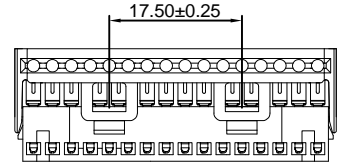

16P~20P

Ordering Information:  
A2502HWV-XP - \* - \*\* - \*\*  
1 2 3

- Part No.
- Material:  
(Blank):PBT,UL94V-0  
GWT:PBT,UL94V-0,GWT 750°C
- Finish:  
(blank):Tin over Nickel  
G:Gold over Nickel

Ordering Information & Dimensions

PART NO.	Dimensions	
	A	B
2P	2.50	7.40
3P	5.00	9.90
4P	7.50	12.40
5P	10.00	14.90
6P	12.50	17.40
7P	15.00	19.90
8P	17.50	22.40
9P	20.00	24.90
10P	22.50	27.40
11P	25.00	29.90
12P	27.50	32.40
13P	30.00	34.90
14P	32.50	37.40
15P	35.00	39.90
16P	37.50	42.40
17P	40.00	44.90
18P	42.50	47.40
19P	45.00	49.90
20P	47.50	52.40

Unit: mm

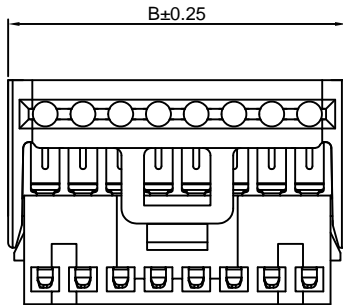

8P~15P

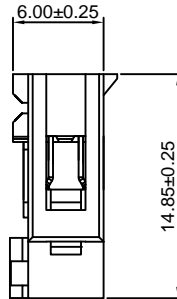

### A2502WV-XP

2.50mm pitch 180° Wafer

**Reference Informations:**

- \*Material:Pin:Brass/Tin over Nickel  
Insulator:Nylon 66,UL94V-0
- \*Mates with CJT A2502H-XP series Housing
- \*Color:White

Ordering Information:  
A2502WV-XP - \* - \*\* - \*\* - \*\*  
1 2 3 4 5

- Part No.
- Style  
(blank):Type 1  
2:Type 2
- Material:  
(Blank):Nylon 66,UL94V-0  
GWT:Nylon 66,UL94V-0,GWT 750°C
- Color:  
(Blank):White  
RD:Red  
BL:Blue  
GN:Green  
YL:Yellow  
BK:Black
- Finish:  
(blank):Tin over Nickel  
G:Gold over Nickel

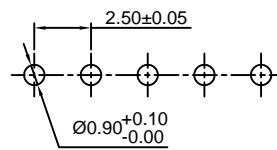
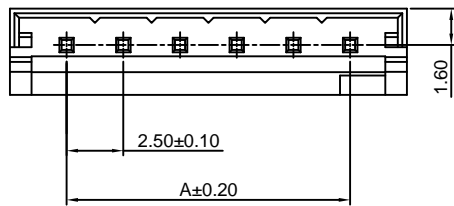

P.C.B LAYOUT

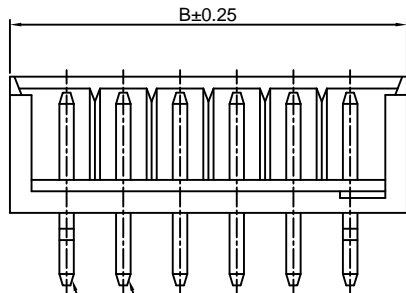
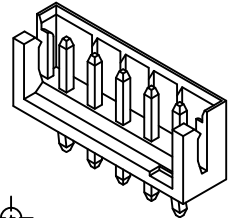

Circuit 1

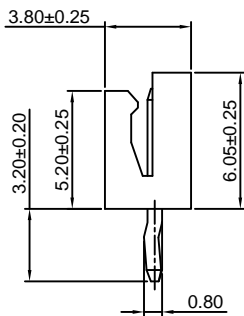

TYPE 1

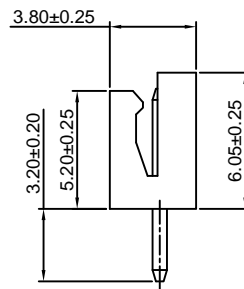

TYPE 2

Ordering Information & Dimensions

PART NO.	Dimensions	
	A	B
2P	2.50	7.50
3P	5.00	10.00
4P	7.50	12.50
5P	10.00	15.00
6P	12.50	17.50
7P	15.00	20.00
8P	17.50	22.50
9P	20.00	25.00
10P	22.50	27.50
11P	25.00	30.00
12P	27.50	32.50
13P	30.00	35.00
14P	32.50	37.50
15P	35.00	40.00

Unit: mm

### A2502WR-XP

2.50mm pitch 90° Wafer

#### Reference Informations:

- \*Material:Pin:Brass/Tin over Nickel  
Insulator:Nylon 66,UL94V-0
- \*Mates with CJT A2502H-XP series Housing
- \*Color:White

#### Ordering Information:

A2502WR-XP - \* - \*\*\* - \*\* - \*\*  
1 2 3 4 5

- Part No.
- Style  
(blank):Type 1  
2:Type 2
- Material:  
(Blank):Nylon 66,UL94V-0  
GWT:Nylon 66,UL94V-0,GWT 750 °C
- Color:  
(Blank):White  
RD:Red OR:Orange  
YL:Yellow GY:Gray  
BL:Blue BK:Pink  
BK:Black BR:Brown  
GN:Green VJ:Violet  
TR:Tomato red LY:Lemon yellow  
LE:Light blue VY:Vivid yellow
- Finish:  
(blank):Tin over Nickel  
G:Gold over Nickel

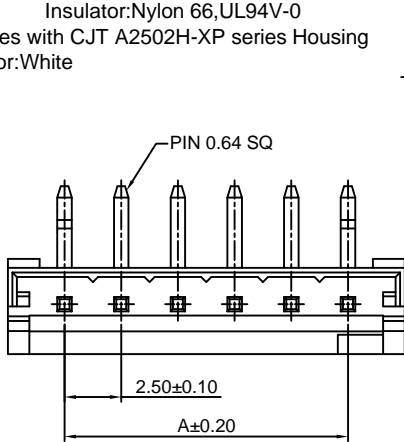
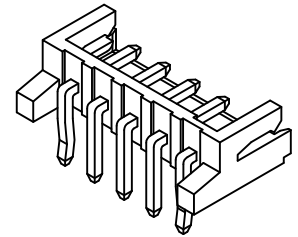

P.C.B LAYOUT

TYPE 2

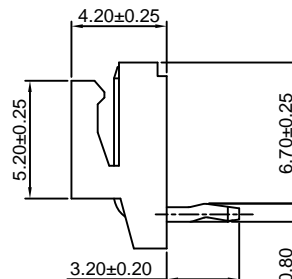
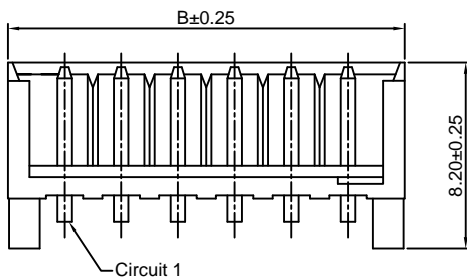

TYPE 1

#### Ordering Information & Dimensions

PART NO.	Dimensions	
	A	B
2P	2.50	7.50
3P	5.00	10.00
4P	7.50	12.50
5P	10.00	15.00
6P	12.50	17.50
7P	15.00	20.00
8P	17.50	22.50
9P	20.00	25.00
10P	22.50	27.50
11P	25.00	30.00
12P	27.50	32.50
13P	30.00	35.00
14P	32.50	37.50
15P	35.00	40.00

Unit: mm

### A2502WVA-XP

2.50mm pitch 180° Wafer

#### Reference Informations:

- \*Material:Pin:Brass/Tin over Nickel  
Insulator:PBT+15%GF,UL94V-0
- \*Mates with CJT A2502HWV-XP series Housing
- \*Color:Gray

#### Ordering Information:

A2502WVA-XP - \*\*\* - \*\*  
1 2 3

- Part No.
- Material:  
(Blank):PBT,UL94V-0  
GWT:PBT,UL94V-0,GWT 750 °C
- Finish:  
(blank):Tin over Nickel  
G:Gold over Nickel

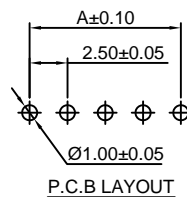
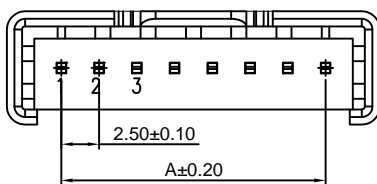

P.C.B LAYOUT

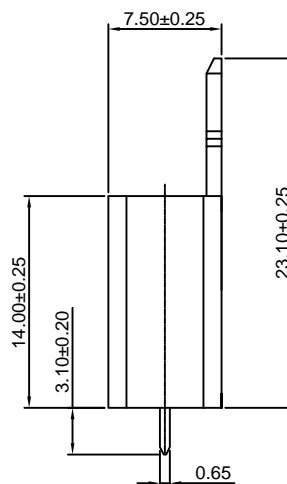
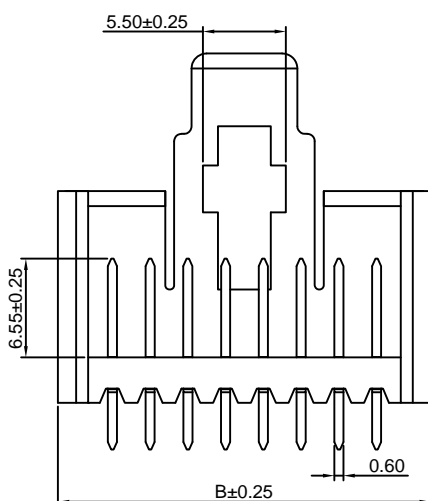

#### Ordering Information & Dimensions

PART NO.	Dimensions	
	A	B
2P	2.50	9.70
3P	5.00	12.20
4P	7.50	14.70
5P	10.00	17.20
6P	12.50	19.70
7P	15.00	22.20
8P	17.50	24.70
9P	20.00	27.20
10P	22.50	29.70
11P	25.00	32.20
12P	27.50	34.70
13P	30.00	37.20
14P	32.50	39.70
15P	35.00	42.20
16P	37.50	44.70
17P	40.00	47.20
18P	42.50	49.70
19P	45.00	52.20
20P	47.50	54.70

Unit: mm

### A2502WRA-XP

2.50mm pitch 90° Wafer

#### Reference Informations:

- \*Material:Pin:Brass/Tin over Nickel  
Insulator:PBT+15%GF,UL94V-0
- \*Mates with CJT A2502HWV-XP series Housing
- \*Color:Gray

#### Ordering Information:

A2502WRA-XP - \*\*\* - \*\*  
1 2 3

1. Part No.
2. Material:  
(Blank):PBT,UL94V-0  
GWT:PBT,UL94V-0,GWT 750 °C
3. Finish:  
(blank):Tin over Nickel  
G:Gold over Nickel

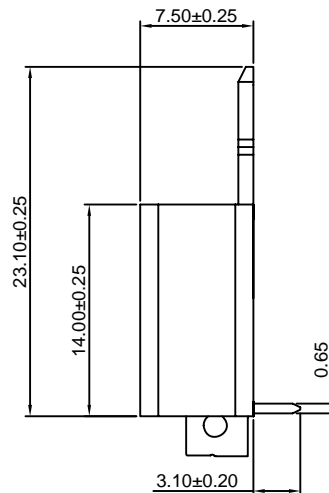
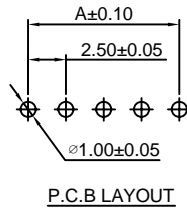
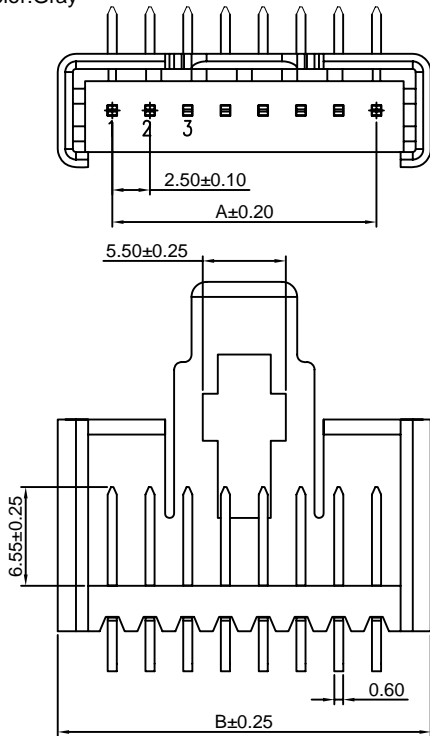

#### Ordering Information & Dimensions

PART NO.	Dimensions	
	A	B
2P	2.50	9.70
3P	5.00	12.20
4P	7.50	14.70
5P	10.00	17.20
6P	12.50	19.70
7P	15.00	22.20
8P	17.50	24.70
9P	20.00	27.20
10P	22.50	29.70
11P	25.00	32.20
12P	27.50	34.70
13P	30.00	37.20
14P	32.50	39.70
15P	35.00	42.20
16P	37.50	44.70
17P	40.00	47.20
18P	42.50	49.70
19P	45.00	52.20
20P	47.50	54.70

Unit: mm

### A2502WVA-N-XP

2.50mm pitch 180° Wafer

#### Reference Informations:

- \*Material:Pin:Brass/Tin over Nickel  
Insulator:PBT+15%GF,UL94V-0
- \*Mates with CJT A2502HWV-XP series Housing
- \*Color:Gray

#### Ordering Information:

A2502WVA-N-XP - \*\*\* - \*\*  
1 2 3

1. Part No.
2. Material:  
(Blank):PBT,UL94V-0  
GWT:PBT,UL94V-0,GWT 750 °C
3. Finish:  
(blank):Tin over Nickel  
G:Gold over Nickel

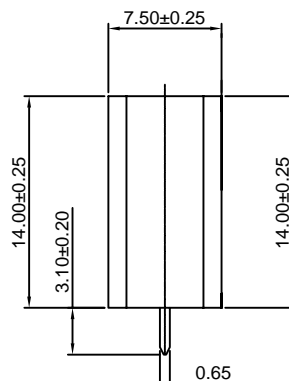
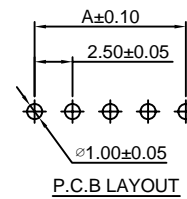
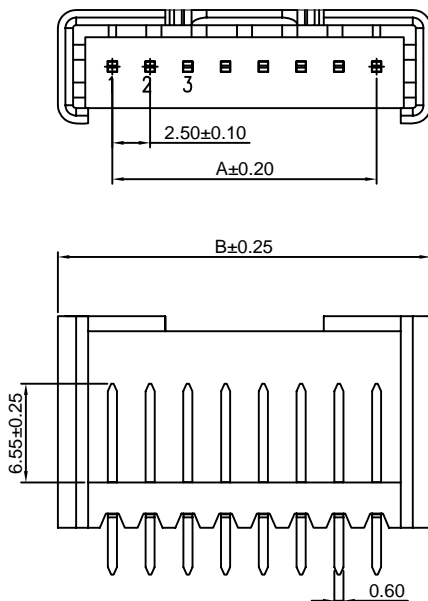

#### Ordering Information & Dimensions

PART NO.	Dimensions	
	A	B
2P	2.50	9.70
3P	5.00	12.20
4P	7.50	14.70
5P	10.00	17.20
6P	12.50	19.70
7P	15.00	22.20
8P	17.50	24.70
9P	20.00	27.20
10P	22.50	29.70
11P	25.00	32.20
12P	27.50	34.70
13P	30.00	37.20
14P	32.50	39.70
15P	35.00	42.20
16P	37.50	44.70
17P	40.00	47.20
18P	42.50	49.70
19P	45.00	52.20
20P	47.50	54.70

Unit: mm

### A2502WRA-N-XP

2.50mm pitch 90° Wafer

#### Reference Informations:

- \*Material: Pin: Brass/Tin over Nickel  
Insulator: PBT+15%GF, UL94V-0
- \*Mates with CJT A2502HWV-XP series Housing
- \*Color: Gray

Ordering Information:  
A2502WRA-N-XP - \*\*\* - \*\*  
1                      2   3

- Part No.
- Material:  
(Blank): PBT, UL94V-0  
GWT: PBT, UL94V-0, GWT 750°C
- Finish:  
(blank): Tin over Nickel  
G: Gold over Nickel

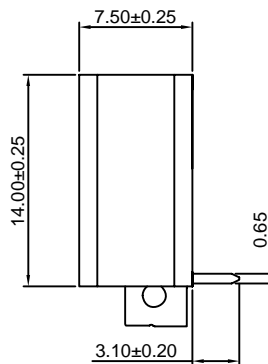
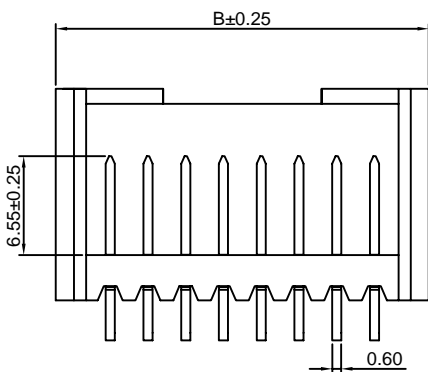
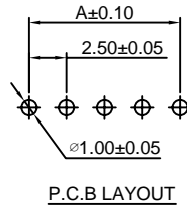
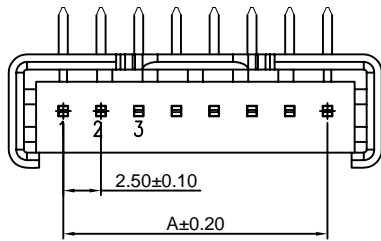

#### Ordering Information & Dimensions

PART NO.	Dimensions	
	A	B
2P	2.50	9.70
3P	5.00	12.20
4P	7.50	14.70
5P	10.00	17.20
6P	12.50	19.70
7P	15.00	22.20
8P	17.50	24.70
9P	20.00	27.20
10P	22.50	29.70
11P	25.00	32.20
12P	27.50	34.70
13P	30.00	37.20
14P	32.50	39.70
15P	35.00	42.20
16P	37.50	44.70
17P	40.00	47.20
18P	42.50	49.70
19P	45.00	52.20
20P	47.50	54.70

Unit: mm

### A2502WVB-XP

2.50mm pitch 180° Wafer

#### Reference Informations:

- \*Material: Pin: Brass/Tin over Nickel  
Insulator: PBT+15%GF, UL94V-0
- \*Mates with CJT A2502HWV-XP series Housing
- \*Color: Gray

Ordering Information:  
A2502WVB-XP - \*\*\* - \*\*\* - \*\*  
1                      2   3   4

- Part No.
- Style:  
(Blank): TYPE 1  
2: TYPE 2
- Material:  
(Blank): PBT, UL94V-0  
GWT: PBT, UL94V-0, GWT 750°C
- Finish:  
(blank): Tin over Nickel  
G: Gold over Nickel

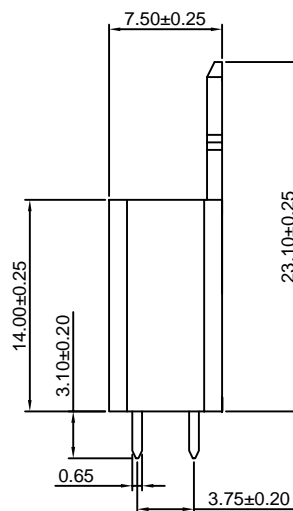
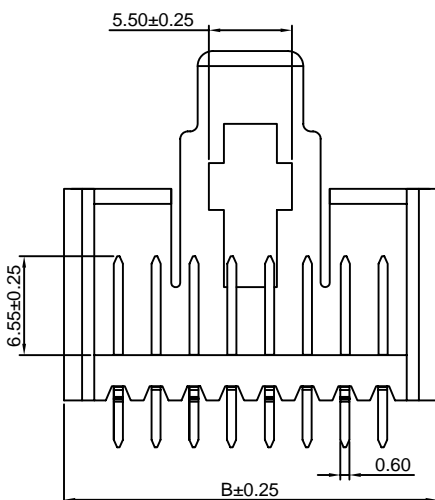
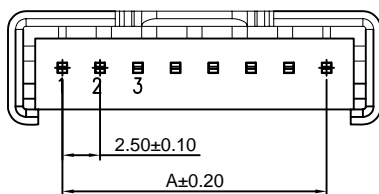
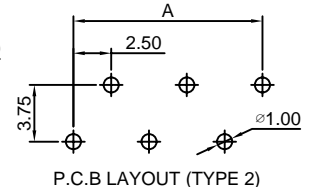
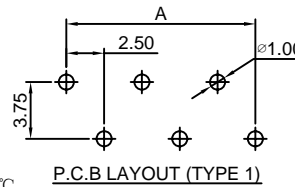

#### Ordering Information & Dimensions

PART NO.	Dimensions	
	A	B
2P	2.50	9.70
3P	5.00	12.20
4P	7.50	14.70
5P	10.00	17.20
6P	12.50	19.70
7P	15.00	22.20
8P	17.50	24.70
9P	20.00	27.20
10P	22.50	29.70
11P	25.00	32.20
12P	27.50	34.70
13P	30.00	37.20
14P	32.50	39.70
15P	35.00	42.20
16P	37.50	44.70
17P	40.00	47.20
18P	42.50	49.70
19P	45.00	52.20
20P	47.50	54.70

Unit: mm

### A2502WRB-XP

2.50mm pitch 90° Wafer

#### Reference Informations:

- \*Material: Pin: Brass/Tin over Nickel  
Insulator: PBT+15%GF, UL94V-0
- \*Mates with CJT A2502HWV-XP series Housing
- \*Color: Gray

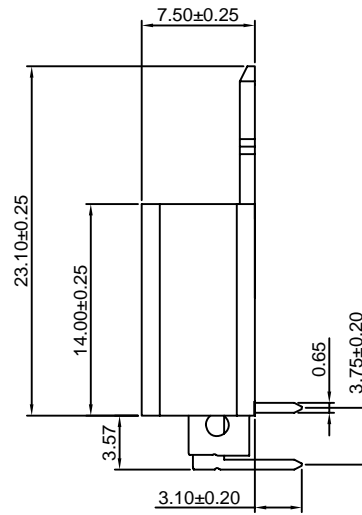
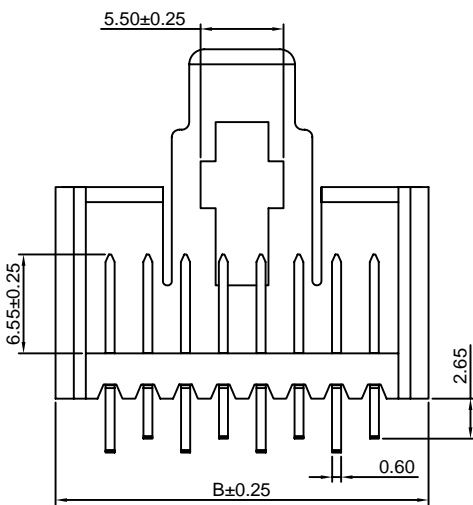
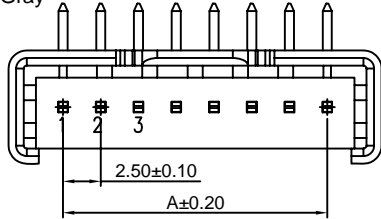

Ordering Information:  
A2502WRB-XP - \*\*\* - \*\*\* - \*\*  
1 2 3 4

1. Part No.
2. Style:  
(Blank): TYPE 1  
2: TYPE 2
3. Material:  
(Blank): PBT, UL94V-0  
GWT: PBT, UL94V-0, GWT 750°C
4. Finish:  
(blank): Tin over Nickel  
G: Gold over Nickel

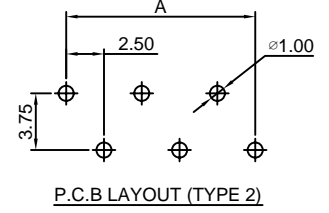
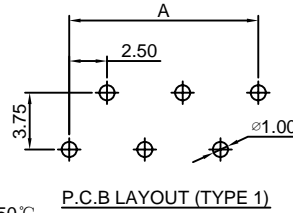

#### Ordering Information & Dimensions

PART NO.	Dimensions	
	A	B
2P	2.50	9.70
3P	5.00	12.20
4P	7.50	14.70
5P	10.00	17.20
6P	12.50	19.70
7P	15.00	22.20
8P	17.50	24.70
9P	20.00	27.20
10P	22.50	29.70
11P	25.00	32.20
12P	27.50	34.70
13P	30.00	37.20
14P	32.50	39.70
15P	35.00	42.20
16P	37.50	44.70
17P	40.00	47.20
18P	42.50	49.70
19P	45.00	52.20
20P	47.50	54.70

Unit: mm

### A2502WVB-N-XP

2.50mm pitch 180° Wafer

#### Reference Informations:

- \*Material: Pin: Brass/Tin over Nickel  
Insulator: PBT+15%GF, UL94V-0
- \*Mates with CJT A2502HWV-XP series Housing
- \*Color: Gray

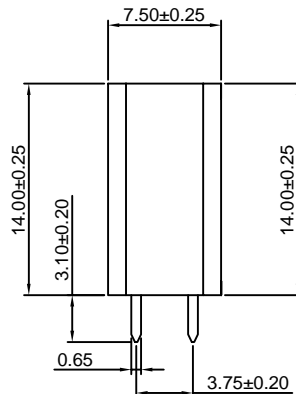
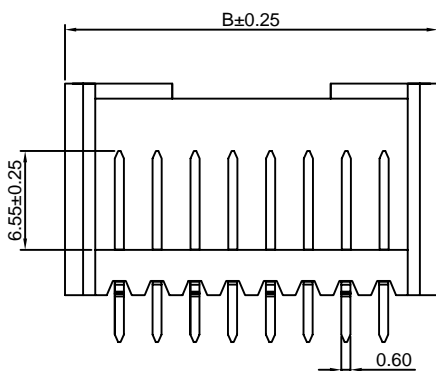
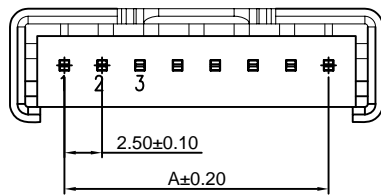

Ordering Information:  
A2502WVB-N-XP - \*\*\* - \*\*\* - \*\*  
1 2 3 4

1. Part No.
2. Style:  
(Blank): TYPE 1  
2: TYPE 2
3. Material:  
(Blank): PBT, UL94V-0  
GWT: PBT, UL94V-0, GWT 750°C
4. Finish:  
(blank): Tin over Nickel  
G: Gold over Nickel

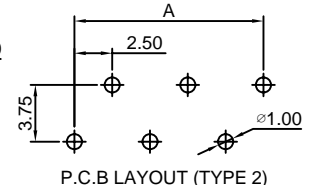
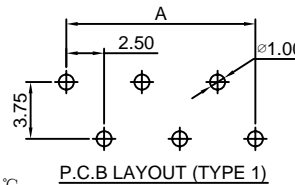

#### Ordering Information & Dimensions

PART NO.	Dimensions	
	A	B
2P	2.50	9.70
3P	5.00	12.20
4P	7.50	14.70
5P	10.00	17.20
6P	12.50	19.70
7P	15.00	22.20
8P	17.50	24.70
9P	20.00	27.20
10P	22.50	29.70
11P	25.00	32.20
12P	27.50	34.70
13P	30.00	37.20
14P	32.50	39.70
15P	35.00	42.20
16P	37.50	44.70
17P	40.00	47.20
18P	42.50	49.70
19P	45.00	52.20
20P	47.50	54.70

Unit: mm

### A2502WRB-N-XP

2.50mm pitch 90° Wafer

#### Reference Informations:

- \*Material: Pin: Brass/Tin over Nickel  
Insulator: PBT +15%GF, UL94V-0
- \*Mates with CJT A2502HWV-XP series Housing
- \*Color: Gray

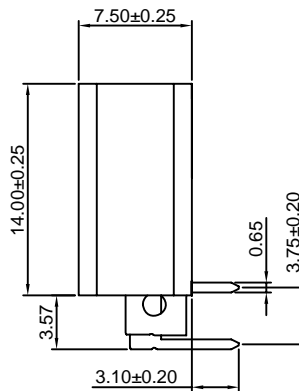
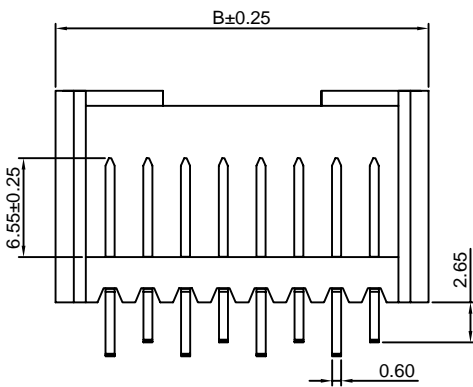
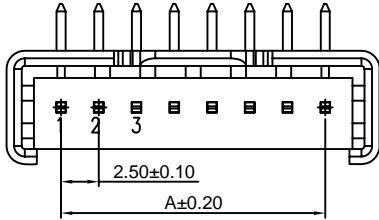

Ordering Information:  
A2502WRB-N-XP - \*\*\* - \*\*\* - \*\*  
1 2 3 4

1. Part No.
2. Style:  
(Blank): TYPE 1  
2: TYPE 2
3. Material:  
(Blank): PBT, UL94V-0  
GWT: PBT, UL94V-0, GWT 750°C
4. Finish:  
(blank): Tin over Nickel  
G: Gold over Nickel

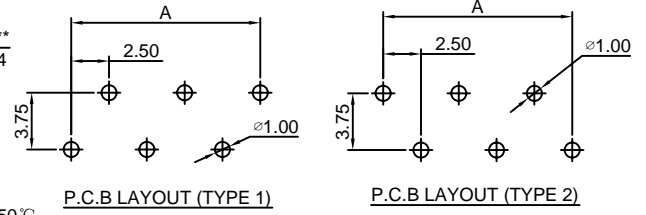

#### Ordering Information & Dimensions

PART NO.	Dimensions	
	A	B
2P	2.50	9.70
3P	5.00	12.20
4P	7.50	14.70
5P	10.00	17.20
6P	12.50	19.70
7P	15.00	22.20
8P	17.50	24.70
9P	20.00	27.20
10P	22.50	29.70
11P	25.00	32.20
12P	27.50	34.70
13P	30.00	37.20
14P	32.50	39.70
15P	35.00	42.20
16P	37.50	44.70
17P	40.00	47.20
18P	42.50	49.70
19P	45.00	52.20
20P	47.50	54.70

Unit: mm



## X-ON Electronics

Largest Supplier of Electrical and Electronic Components

*Click to view similar products for [Headers & Wire Housings](#) category:*

*Click to view products by [Changjiang](#) manufacturer:*

Other Similar products are found below :

[57102-F02-18ULF](#) [58102-G61-06LF](#) [0009485154](#) [009176003701906](#) [0050291907](#) [00-9021-0611-00-339](#) [02.125.8002.8](#) [609-3404](#) [61062-3](#)  
[622-0430](#) [622-3653LF](#) [63453-116](#) [636-1030](#) [636-1427](#) [636-3427](#) [636-4007](#) [641938-9](#) [644827-2](#) [65495-038](#) [65692-001LF](#) [65781-018](#)  
[65781-047](#) [65817-010LF](#) [65817-015LF](#) [66207-023LF](#) [67016-026LF](#) [67095-007LF](#) [68631-112](#) [68645-018](#) [68648-049](#) [699319-000](#)  
[70.362.1628.0](#) [70-4210](#) [70-4226B](#) [70-4853B](#) [707-5020](#) [707-5028](#) [71.350.2428.0](#) [71961-016LF](#) [733-134](#) [754199-000](#) [760-3052](#) [787-8014-00](#)  
[FCN-367T-T012/H](#) [80.063.4001.1](#) [800-90-001-10-001000](#) [800-90-010-10-002000](#) [801-43-002-10-013000](#) [801-43-006-10-002000](#)  
[803-41-018-10-001000](#)