

Specifications

- Current rating:3A AC,DC
- Voltage rating:250V AC,DC
- Temperature range:-40°C~+105°C
- Contact resistance:10mΩMax.
- Insulation resistance:1000MΩMin.
- Withstanding voltage:800V AC/minute
- *Compliant with RoHS and REACH*
- *Meet the HF/Halogen Free,need to customize*
- *Contact CJT for details*

Standards



Assembly layout

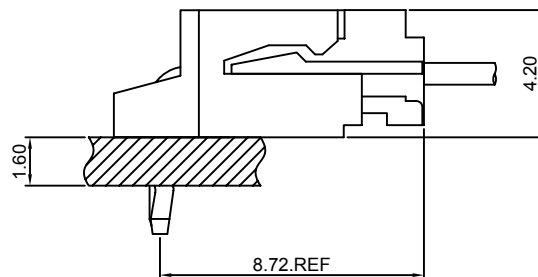
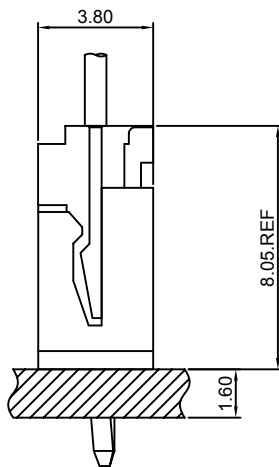

A2502-T

2.50mm pitch Crimp Terminal

Reference Informations:

*Used in CJT A2502H-XP, A2511H-XP series Housing

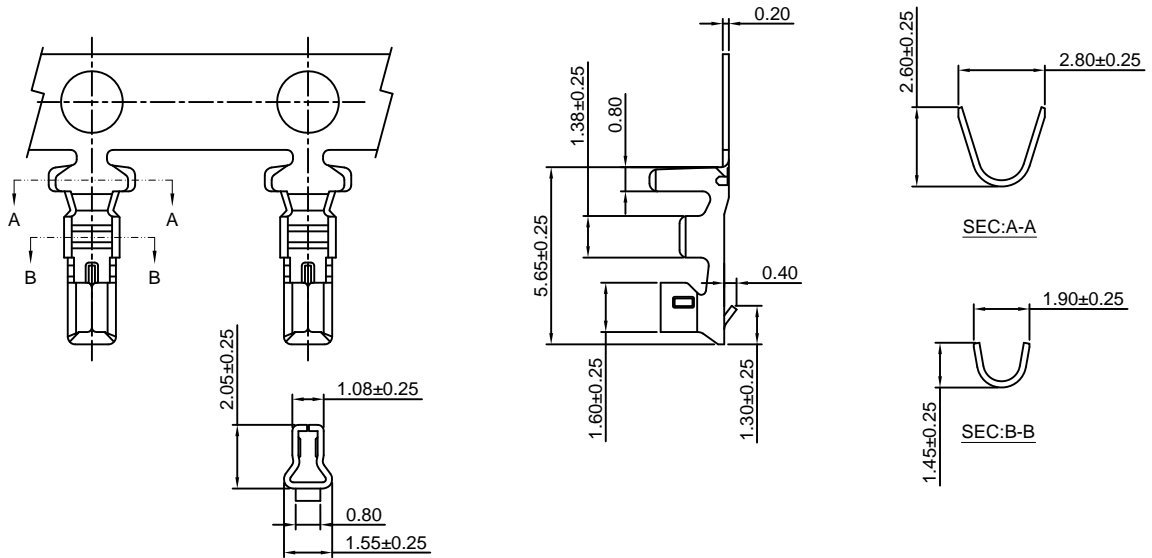

Ordering information & Specifications

Unit:mm

| Part NO. | Wire Range | Insulation O.D. | Material | Finish | Qty/reel |
|----------|------------|-----------------|-----------------|------------------|------------|
| A2502-TP | AWG#22-#30 | 1.90mm(max) | Phosphor Bronze | Tin over Nickel | 10,000 PCS |
| A2502-GP | AWG#22-#30 | 1.90mm(max) | Phosphor Bronze | Gold over Nickel | 10,000 PCS |

Optional Gold plating available but MOQ requested

A2502H-XP

2.50mm pitch Housing

Reference Informations:

*Material:Nylon 66,UL94V-0

*Suitable CJT A2502-T series Terminal

*Mates with CJT A2502WV,WR-XP series Wafer

*Color:White

Ordering Information:

A2502H-XP - *** - **
1 2 3

1.Part No.

2.Material:

(Blank):Nylon 66,UL94V-0

GWT:Nylon 66,UL94V-0,GWT 750°C

3.Color:

(Blank):White

RD:Red

YL:Yellow

BL:Blue

BK:Black

GN:Green

TR:Tomato red

LE:Light blue

OR:Orange

GY:Gray

PK:Pink

BR:Brown

VI:Violet

LY:Lemon yellow

VY:Vivid yellow

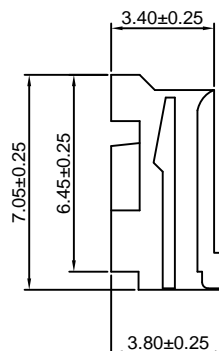
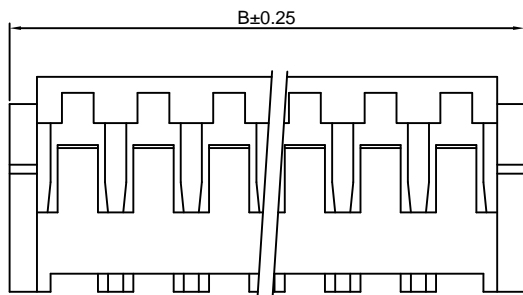
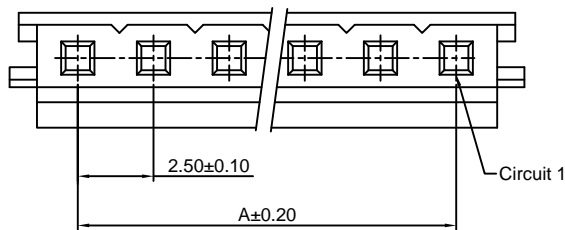
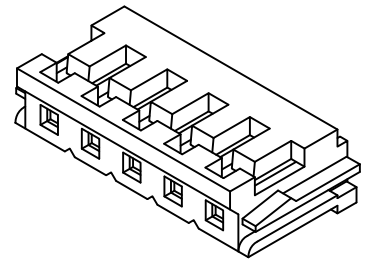

Ordering Information & Dimensions

| PART NO. | Dimensions | |
|----------|------------|-------|
| | A | B |
| 2P | 2.50 | 7.00 |
| 3P | 5.00 | 9.50 |
| 4P | 7.50 | 12.00 |
| 5P | 10.00 | 14.50 |
| 6P | 12.50 | 17.00 |
| 7P | 15.00 | 19.50 |
| 8P | 17.50 | 22.00 |
| 9P | 20.00 | 24.50 |
| 10P | 22.50 | 27.00 |
| 11P | 25.00 | 29.50 |
| 12P | 27.50 | 32.00 |
| 13P | 30.00 | 34.50 |
| 14P | 32.50 | 37.00 |
| 15P | 35.00 | 39.50 |

Unit: mm

A2502HWV-XP

2.50mm pitch Housing

Reference Informations:

*Material:Pin:Phosphor Bronze/Tin over Nickel
Insulator:PBT,UL94V-0

*Mates with CJT A2502WVA,WRA-XP,A2502WVB,WRB-XP,
A2502WVA-N,WRA-N-XP,A2502WVB-N,WRB-N-XP series Wafer

*Color:Gray

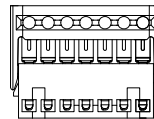
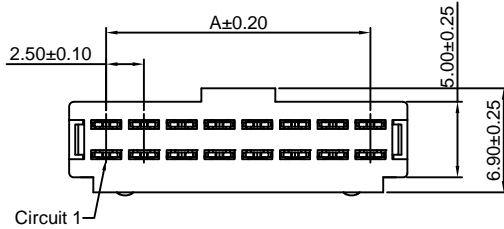

2P~7P

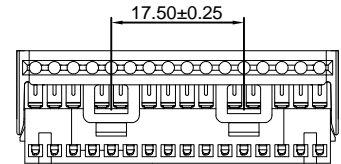

16P~20P

Ordering Information:

A2502HWV-XP - * - ** - **
1 2 3

1.Part No.

2.Material:

(Blank):PBT,UL94V-0

GWT:PBT,UL94V-0,GWT 750℃

3.Finish:

(blank):Tin over Nickel

G:Gold over Nickel

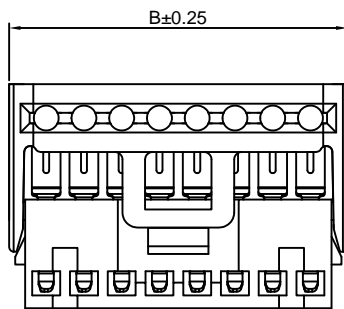

8P~15P

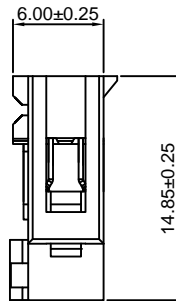

Ordering Information & Dimensions

| PART NO. | Dimensions | |
|----------|------------|-------|
| | A | B |
| 2P | 2.50 | 7.40 |
| 3P | 5.00 | 9.90 |
| 4P | 7.50 | 12.40 |
| 5P | 10.00 | 14.90 |
| 6P | 12.50 | 17.40 |
| 7P | 15.00 | 19.90 |
| 8P | 17.50 | 22.40 |
| 9P | 20.00 | 24.90 |
| 10P | 22.50 | 27.40 |
| 11P | 25.00 | 29.90 |
| 12P | 27.50 | 32.40 |
| 13P | 30.00 | 34.90 |
| 14P | 32.50 | 37.40 |
| 15P | 35.00 | 39.90 |
| 16P | 37.50 | 42.40 |
| 17P | 40.00 | 44.90 |
| 18P | 42.50 | 47.40 |
| 19P | 45.00 | 49.90 |
| 20P | 47.50 | 52.40 |

Unit: mm

A2502WV-XP

2.50mm pitch 180° Wafer

Reference Informations:

*Material:Pin:Brass/Tin over Nickel
Insulator:Nylon 66,UL94V-0

*Mates with CJT A2502H-XP series Housing

*Color:White

Ordering Information:

A2502WV-XP - * - ** - ** - **
1 2 3 4 5

1.Part No.

2.Style

(blank):Type 1

2:Type 2

3.Material:

(Blank):Nylon 66,UL94V-0

GWT:Nylon 66,UL94V-0,GWT 750℃

4.Color:

(Blank):White

RD:Red

YL:Yellow

BL:Blue

BK:Black

GN:Green

5.Finish:

(blank):Tin over Nickel

G:Gold over Nickel

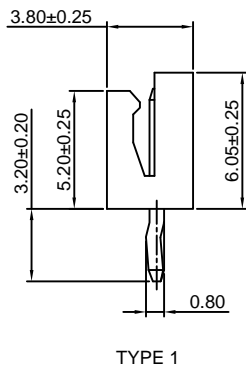
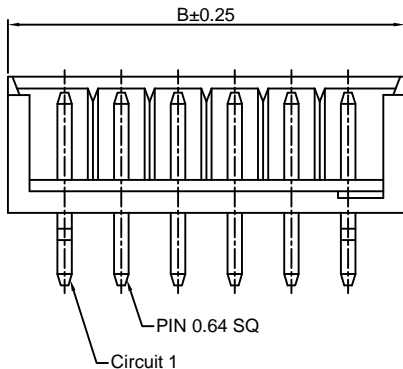
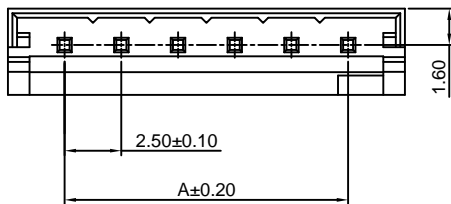

TYPE 1

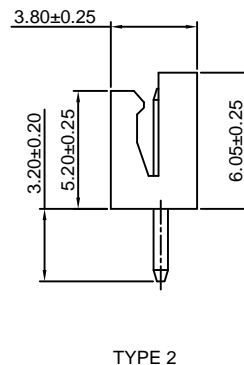

TYPE 2

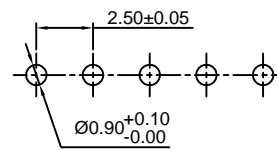

P.C.B LAYOUT

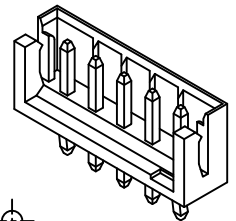

Ordering Information & Dimensions

| PART NO. | Dimensions | |
|----------|------------|-------|
| | A | B |
| 2P | 2.50 | 7.50 |
| 3P | 5.00 | 10.00 |
| 4P | 7.50 | 12.50 |
| 5P | 10.00 | 15.00 |
| 6P | 12.50 | 17.50 |
| 7P | 15.00 | 20.00 |
| 8P | 17.50 | 22.50 |
| 9P | 20.00 | 25.00 |
| 10P | 22.50 | 27.50 |
| 11P | 25.00 | 30.00 |
| 12P | 27.50 | 32.50 |
| 13P | 30.00 | 35.00 |
| 14P | 32.50 | 37.50 |
| 15P | 35.00 | 40.00 |

Unit: mm

A2502WR-XP

2.50mm pitch 90° Wafer

Reference Informations:

- *Material:Pin:Brass/Tin over Nickel
Insulator:Nylon 66,UL94V-0
- *Mates with CJT A2502H-XP series Housing
- *Color:White

Ordering Information:

A2502WR-XP - * - *** - ** - **
1 2 3 4 5

- Part No.
- Style
(blank):Type 1
2:Type 2
- Material:
(Blank):Nylon 66,UL94V-0
GWT:Nylon 66,UL94V-0,GWT 750 °C
- Color:
(Blank):White
RD:Red OR:Orange
YL:Yellow GY:Gray
BL:Blue PK:Pink
BK:Black BR:Brown
GN:Green VJ:Violet
TR:Tomato red LY:Lemon yellow
LE:Light blue VY:Vivid yellow
- Finish:
(blank):Tin over Nickel
G:Gold over Nickel

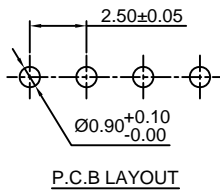
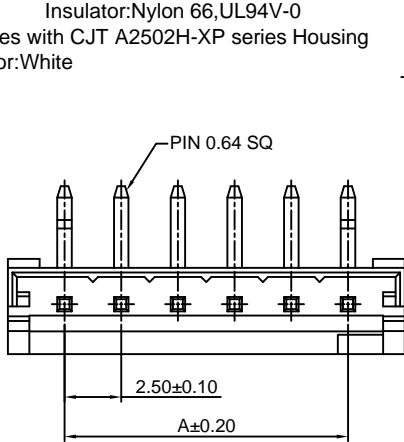
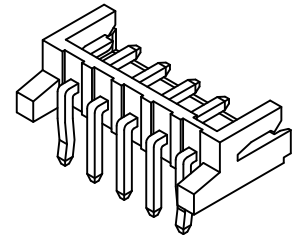

P.C.B LAYOUT

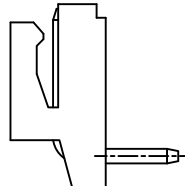

TYPE 2

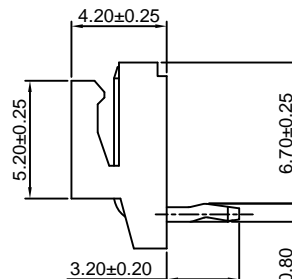
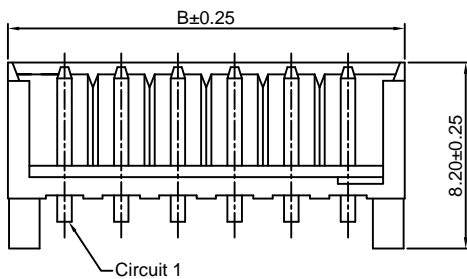

TYPE 1

Ordering Information & Dimensions

| PART NO. | Dimensions | |
|----------|------------|-------|
| | A | B |
| 2P | 2.50 | 7.50 |
| 3P | 5.00 | 10.00 |
| 4P | 7.50 | 12.50 |
| 5P | 10.00 | 15.00 |
| 6P | 12.50 | 17.50 |
| 7P | 15.00 | 20.00 |
| 8P | 17.50 | 22.50 |
| 9P | 20.00 | 25.00 |
| 10P | 22.50 | 27.50 |
| 11P | 25.00 | 30.00 |
| 12P | 27.50 | 32.50 |
| 13P | 30.00 | 35.00 |
| 14P | 32.50 | 37.50 |
| 15P | 35.00 | 40.00 |

Unit: mm

A2502WVA-XP

2.50mm pitch 180° Wafer

Reference Informations:

- *Material:Pin:Brass/Tin over Nickel
Insulator:PBT+15%GF,UL94V-0
- *Mates with CJT A2502HWV-XP series Housing
- *Color:Gray

Ordering Information:

A2502WVA-XP - *** - **
1 2 3

- Part No.
- Material:
(Blank):PBT,UL94V-0
GWT:PBT,UL94V-0,GWT 750 °C
- Finish:
(blank):Tin over Nickel
G:Gold over Nickel

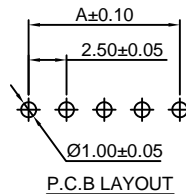
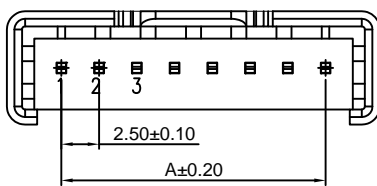

P.C.B LAYOUT

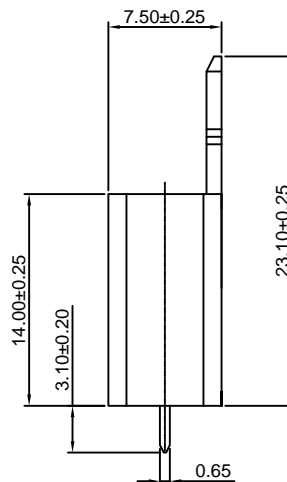
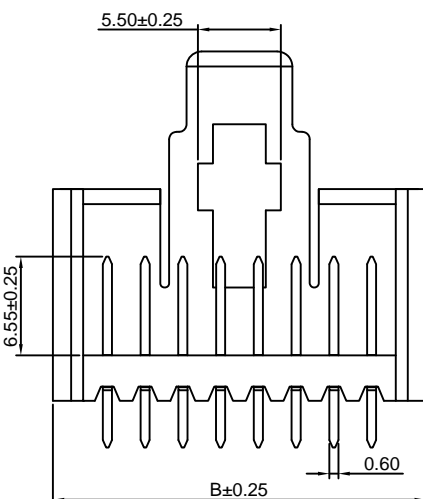

Ordering Information & Dimensions

| PART NO. | Dimensions | |
|----------|------------|-------|
| | A | B |
| 2P | 2.50 | 9.70 |
| 3P | 5.00 | 12.20 |
| 4P | 7.50 | 14.70 |
| 5P | 10.00 | 17.20 |
| 6P | 12.50 | 19.70 |
| 7P | 15.00 | 22.20 |
| 8P | 17.50 | 24.70 |
| 9P | 20.00 | 27.20 |
| 10P | 22.50 | 29.70 |
| 11P | 25.00 | 32.20 |
| 12P | 27.50 | 34.70 |
| 13P | 30.00 | 37.20 |
| 14P | 32.50 | 39.70 |
| 15P | 35.00 | 42.20 |
| 16P | 37.50 | 44.70 |
| 17P | 40.00 | 47.20 |
| 18P | 42.50 | 49.70 |
| 19P | 45.00 | 52.20 |
| 20P | 47.50 | 54.70 |

Unit: mm

A2502WRA-XP

2.50mm pitch 90° Wafer

Reference Informations:

- *Material:Pin:Brass/Tin over Nickel
Insulator:PBT+15%GF,UL94V-0
- *Mates with CJT A2502HWV-XP series Housing
- *Color:Gray

Ordering Information:
A2502WRA-XP - *** - **
1 2 3

- 1.Part No.
- 2.Material:
(Blank):PBT,UL94V-0
GWT:PBT,UL94V-0,GWT 750 °C
- 3.Finish:
(blank):Tin over Nickel
G:Gold over Nickel

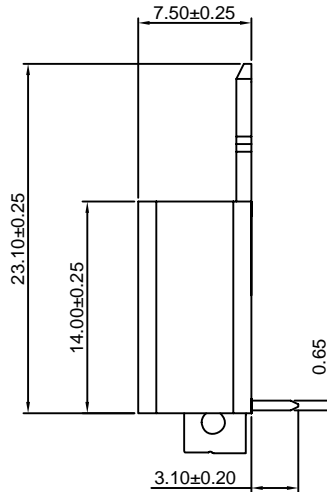
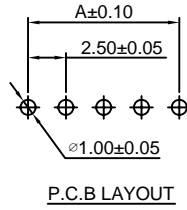
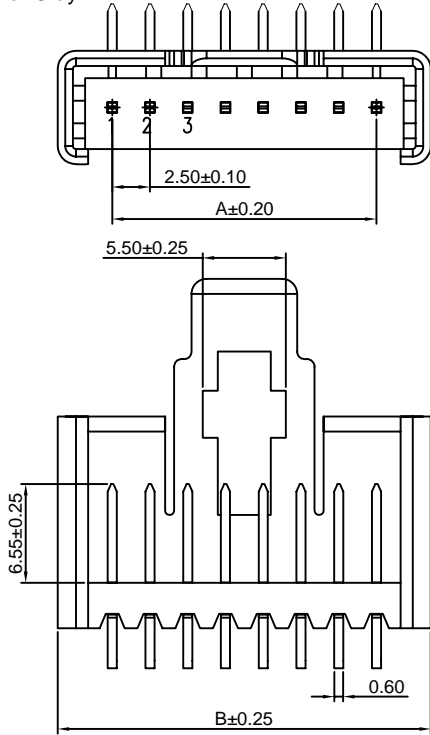

Ordering Information & Dimensions

| PART NO. | Dimensions | |
|----------|------------|-------|
| | A | B |
| 2P | 2.50 | 9.70 |
| 3P | 5.00 | 12.20 |
| 4P | 7.50 | 14.70 |
| 5P | 10.00 | 17.20 |
| 6P | 12.50 | 19.70 |
| 7P | 15.00 | 22.20 |
| 8P | 17.50 | 24.70 |
| 9P | 20.00 | 27.20 |
| 10P | 22.50 | 29.70 |
| 11P | 25.00 | 32.20 |
| 12P | 27.50 | 34.70 |
| 13P | 30.00 | 37.20 |
| 14P | 32.50 | 39.70 |
| 15P | 35.00 | 42.20 |
| 16P | 37.50 | 44.70 |
| 17P | 40.00 | 47.20 |
| 18P | 42.50 | 49.70 |
| 19P | 45.00 | 52.20 |
| 20P | 47.50 | 54.70 |

Unit: mm

A2502WVA-N-XP

2.50mm pitch 180° Wafer

Reference Informations:

- *Material:Pin:Brass/Tin over Nickel
Insulator:PBT+15%GF,UL94V-0
- *Mates with CJT A2502HWV-XP series Housing
- *Color:Gray

Ordering Information:
A2502WVA-N-XP - *** - **
1 2 3

- 1.Part No.
- 2.Material:
(Blank):PBT,UL94V-0
GWT:PBT,UL94V-0,GWT 750 °C
- 3.Finish:
(blank):Tin over Nickel
G:Gold over Nickel

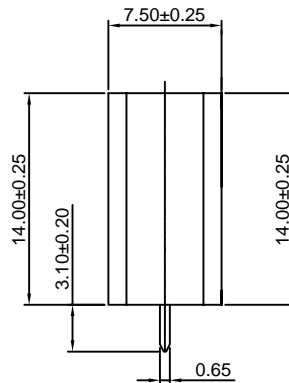
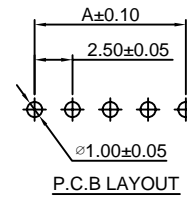
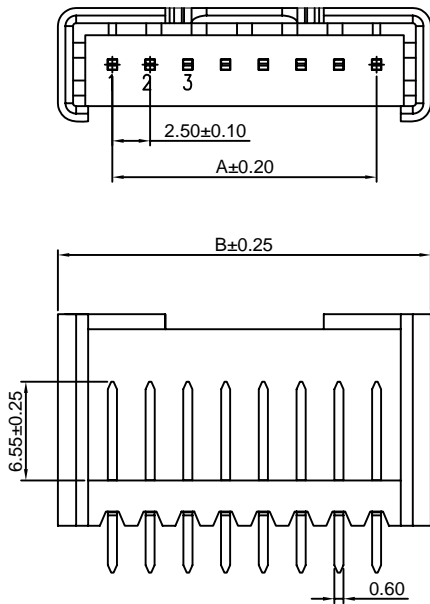

Ordering Information & Dimensions

| PART NO. | Dimensions | |
|----------|------------|-------|
| | A | B |
| 2P | 2.50 | 9.70 |
| 3P | 5.00 | 12.20 |
| 4P | 7.50 | 14.70 |
| 5P | 10.00 | 17.20 |
| 6P | 12.50 | 19.70 |
| 7P | 15.00 | 22.20 |
| 8P | 17.50 | 24.70 |
| 9P | 20.00 | 27.20 |
| 10P | 22.50 | 29.70 |
| 11P | 25.00 | 32.20 |
| 12P | 27.50 | 34.70 |
| 13P | 30.00 | 37.20 |
| 14P | 32.50 | 39.70 |
| 15P | 35.00 | 42.20 |
| 16P | 37.50 | 44.70 |
| 17P | 40.00 | 47.20 |
| 18P | 42.50 | 49.70 |
| 19P | 45.00 | 52.20 |
| 20P | 47.50 | 54.70 |

Unit: mm

A2502WRA-N-XP

2.50mm pitch 90° Wafer

Reference Informations:

- *Material: Pin: Brass/Tin over Nickel
Insulator: PBT+15%GF, UL94V-0
- *Mates with CJT A2502HWV-XP series Housing
- *Color: Gray

Ordering Information:
A2502WRA-N-XP - *** - **
1 2 3

- 1. Part No.
- 2. Material:
(Blank): PBT, UL94V-0
GWT: PBT, UL94V-0, GWT 750°C
- 3. Finish:
(blank): Tin over Nickel
G: Gold over Nickel

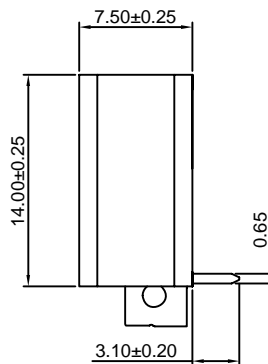
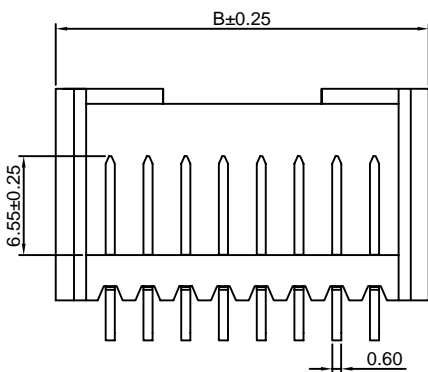
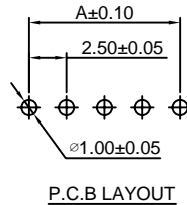
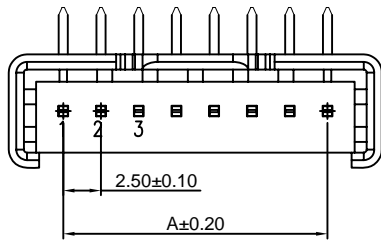

Ordering Information & Dimensions

| PART NO. | Dimensions | |
|----------|------------|-------|
| | A | B |
| 2P | 2.50 | 9.70 |
| 3P | 5.00 | 12.20 |
| 4P | 7.50 | 14.70 |
| 5P | 10.00 | 17.20 |
| 6P | 12.50 | 19.70 |
| 7P | 15.00 | 22.20 |
| 8P | 17.50 | 24.70 |
| 9P | 20.00 | 27.20 |
| 10P | 22.50 | 29.70 |
| 11P | 25.00 | 32.20 |
| 12P | 27.50 | 34.70 |
| 13P | 30.00 | 37.20 |
| 14P | 32.50 | 39.70 |
| 15P | 35.00 | 42.20 |
| 16P | 37.50 | 44.70 |
| 17P | 40.00 | 47.20 |
| 18P | 42.50 | 49.70 |
| 19P | 45.00 | 52.20 |
| 20P | 47.50 | 54.70 |

Unit: mm

A2502WVB-XP

2.50mm pitch 180° Wafer

Reference Informations:

- *Material: Pin: Brass/Tin over Nickel
Insulator: PBT+15%GF, UL94V-0
- *Mates with CJT A2502HWV-XP series Housing
- *Color: Gray

Ordering Information:
A2502WVB-XP - *** - *** - **
1 2 3 4

- 1. Part No.
- 2. Style:
(Blank): TYPE 1
2: TYPE 2
- 3. Material:
(Blank): PBT, UL94V-0
GWT: PBT, UL94V-0, GWT 750°C
- 4. Finish:
(blank): Tin over Nickel
G: Gold over Nickel

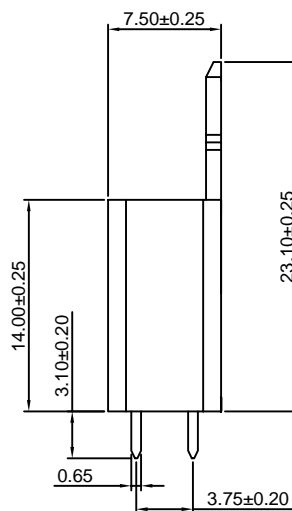
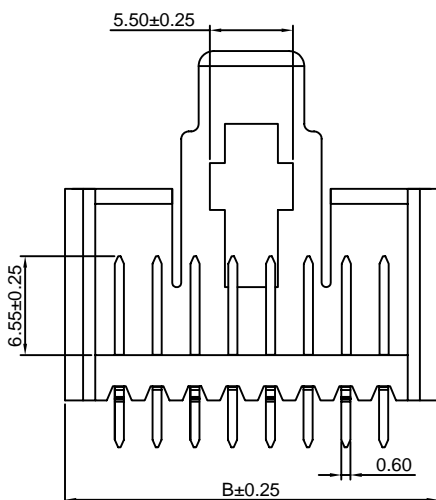
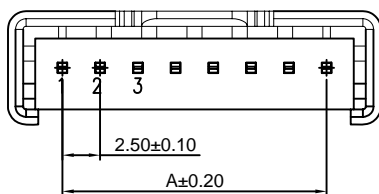
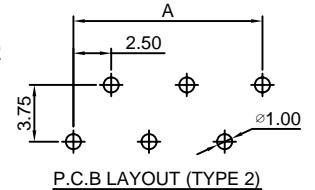
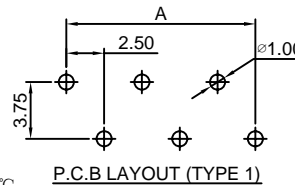

Ordering Information & Dimensions

| PART NO. | Dimensions | |
|----------|------------|-------|
| | A | B |
| 2P | 2.50 | 9.70 |
| 3P | 5.00 | 12.20 |
| 4P | 7.50 | 14.70 |
| 5P | 10.00 | 17.20 |
| 6P | 12.50 | 19.70 |
| 7P | 15.00 | 22.20 |
| 8P | 17.50 | 24.70 |
| 9P | 20.00 | 27.20 |
| 10P | 22.50 | 29.70 |
| 11P | 25.00 | 32.20 |
| 12P | 27.50 | 34.70 |
| 13P | 30.00 | 37.20 |
| 14P | 32.50 | 39.70 |
| 15P | 35.00 | 42.20 |
| 16P | 37.50 | 44.70 |
| 17P | 40.00 | 47.20 |
| 18P | 42.50 | 49.70 |
| 19P | 45.00 | 52.20 |
| 20P | 47.50 | 54.70 |

Unit: mm

A2502WRB-XP

2.50mm pitch 90° Wafer

Reference Informations:

- *Material: Pin: Brass/Tin over Nickel
Insulator: PBT+15%GF, UL94V-0
- *Mates with CJT A2502HWV-XP series Housing
- *Color: Gray

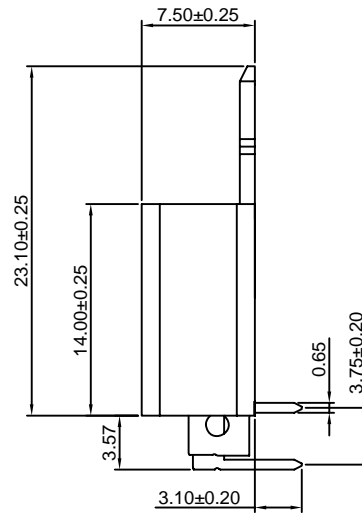
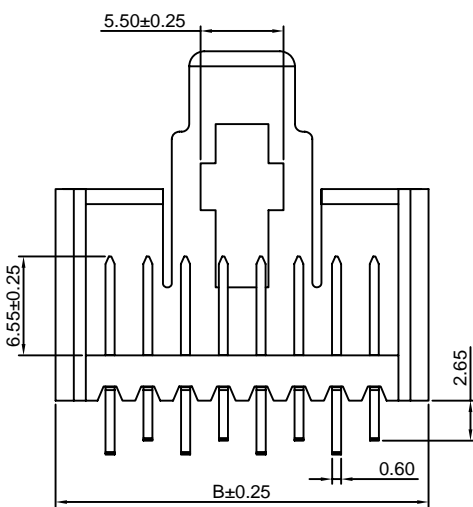
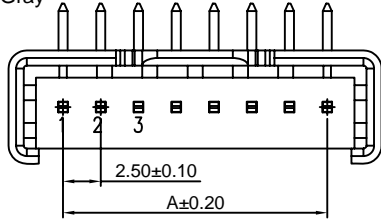

Ordering Information:
A2502WRB-XP - *** - *** - **
1 2 3 4

1. Part No.
2. Style:
(Blank): TYPE 1
2: TYPE 2
3. Material:
(Blank): PBT, UL94V-0
GWT: PBT, UL94V-0, GWT 750°C
4. Finish:
(blank): Tin over Nickel
G: Gold over Nickel

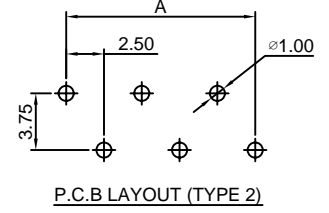
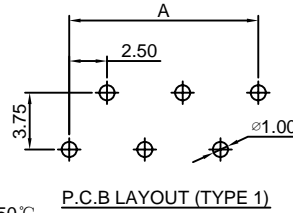

Ordering Information & Dimensions

| PART NO. | Dimensions | |
|----------|------------|-------|
| | A | B |
| 2P | 2.50 | 9.70 |
| 3P | 5.00 | 12.20 |
| 4P | 7.50 | 14.70 |
| 5P | 10.00 | 17.20 |
| 6P | 12.50 | 19.70 |
| 7P | 15.00 | 22.20 |
| 8P | 17.50 | 24.70 |
| 9P | 20.00 | 27.20 |
| 10P | 22.50 | 29.70 |
| 11P | 25.00 | 32.20 |
| 12P | 27.50 | 34.70 |
| 13P | 30.00 | 37.20 |
| 14P | 32.50 | 39.70 |
| 15P | 35.00 | 42.20 |
| 16P | 37.50 | 44.70 |
| 17P | 40.00 | 47.20 |
| 18P | 42.50 | 49.70 |
| 19P | 45.00 | 52.20 |
| 20P | 47.50 | 54.70 |

Unit: mm

A2502WVB-N-XP

2.50mm pitch 180° Wafer

Reference Informations:

- *Material: Pin: Brass/Tin over Nickel
Insulator: PBT+15%GF, UL94V-0
- *Mates with CJT A2502HWV-XP series Housing
- *Color: Gray

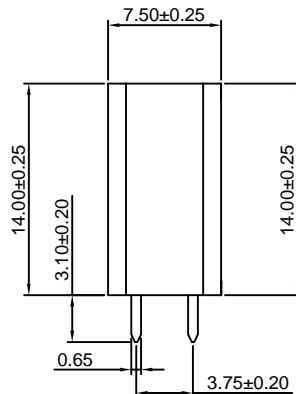
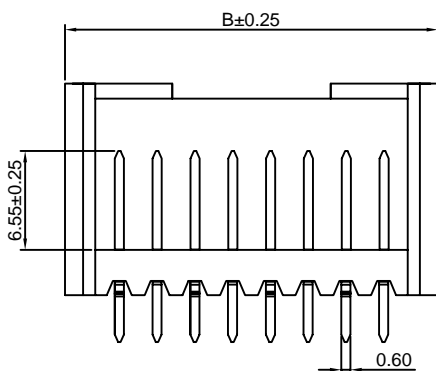
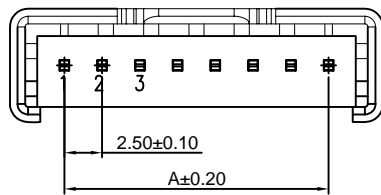

Ordering Information:
A2502WVB-N-XP - *** - *** - **
1 2 3 4

1. Part No.
2. Style:
(Blank): TYPE 1
2: TYPE 2
3. Material:
(Blank): PBT, UL94V-0
GWT: PBT, UL94V-0, GWT 750°C
4. Finish:
(blank): Tin over Nickel
G: Gold over Nickel

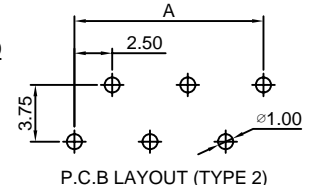
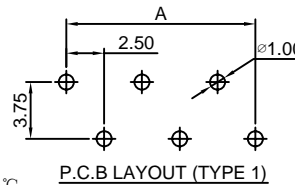

Ordering Information & Dimensions

| PART NO. | Dimensions | |
|----------|------------|-------|
| | A | B |
| 2P | 2.50 | 9.70 |
| 3P | 5.00 | 12.20 |
| 4P | 7.50 | 14.70 |
| 5P | 10.00 | 17.20 |
| 6P | 12.50 | 19.70 |
| 7P | 15.00 | 22.20 |
| 8P | 17.50 | 24.70 |
| 9P | 20.00 | 27.20 |
| 10P | 22.50 | 29.70 |
| 11P | 25.00 | 32.20 |
| 12P | 27.50 | 34.70 |
| 13P | 30.00 | 37.20 |
| 14P | 32.50 | 39.70 |
| 15P | 35.00 | 42.20 |
| 16P | 37.50 | 44.70 |
| 17P | 40.00 | 47.20 |
| 18P | 42.50 | 49.70 |
| 19P | 45.00 | 52.20 |
| 20P | 47.50 | 54.70 |

Unit: mm

A2502WRB-N-XP

2.50mm pitch 90° Wafer

Reference Informations:

- *Material: Pin: Brass/Tin over Nickel
Insulator: PBT +15%GF, UL94V-0
- *Mates with CJT A2502HWV-XP series Housing
- *Color: Gray

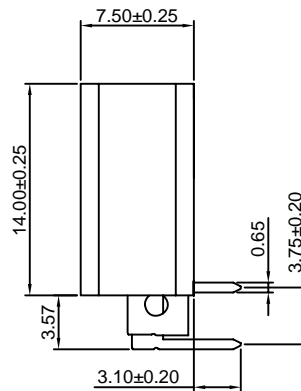
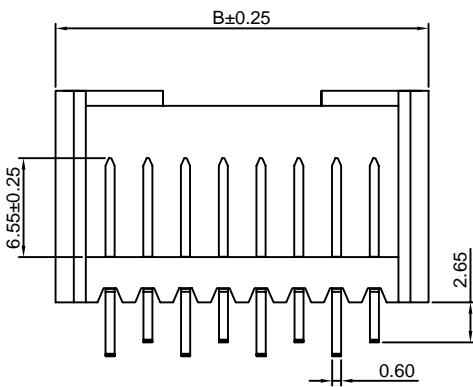
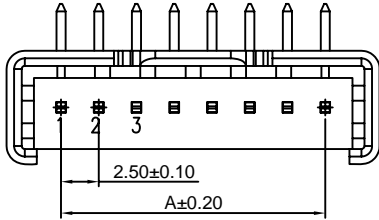

Ordering Information:
A2502WRB-N-XP - *** - *** - **
1 2 3 4

1. Part No.
2. Style:
(Blank): TYPE 1
2: TYPE 2
3. Material:
(Blank): PBT, UL94V-0
GWT: PBT, UL94V-0, GWT 750°C
4. Finish:
(blank): Tin over Nickel
G: Gold over Nickel

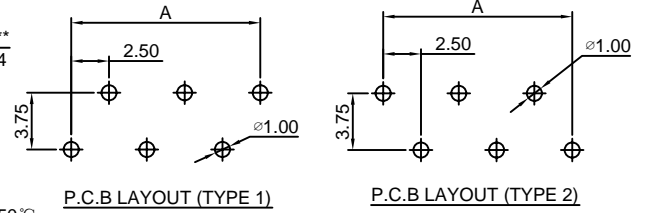

Ordering Information & Dimensions

| PART NO. | Dimensions | |
|----------|------------|-------|
| | A | B |
| 2P | 2.50 | 9.70 |
| 3P | 5.00 | 12.20 |
| 4P | 7.50 | 14.70 |
| 5P | 10.00 | 17.20 |
| 6P | 12.50 | 19.70 |
| 7P | 15.00 | 22.20 |
| 8P | 17.50 | 24.70 |
| 9P | 20.00 | 27.20 |
| 10P | 22.50 | 29.70 |
| 11P | 25.00 | 32.20 |
| 12P | 27.50 | 34.70 |
| 13P | 30.00 | 37.20 |
| 14P | 32.50 | 39.70 |
| 15P | 35.00 | 42.20 |
| 16P | 37.50 | 44.70 |
| 17P | 40.00 | 47.20 |
| 18P | 42.50 | 49.70 |
| 19P | 45.00 | 52.20 |
| 20P | 47.50 | 54.70 |

Unit: mm

X-ON Electronics

Largest Supplier of Electrical and Electronic Components

Click to view similar products for [Headers & Wire Housings](#) category:

Click to view products by [Changjiang](#) manufacturer:

Other Similar products are found below :

[57102-F02-18ULF](#) [58102-G61-06LF](#) [0009485154](#) [009176003701906](#) [0050291907](#) [02.125.8002.8](#) [609-3404](#) [61062-3](#) [622-0430](#) [622-3653LF](#)
[63453-116](#) [636-1030](#) [636-1427](#) [636-3427](#) [636-4007](#) [641938-9](#) [644827-2](#) [65495-038](#) [65692-001LF](#) [65781-018](#) [65781-047](#) [65817-010LF](#)
[65817-015LF](#) [66207-023LF](#) [67016-026LF](#) [67095-007LF](#) [68631-112](#) [68645-018](#) [68648-049](#) [699319-000](#) [70.362.1628.0](#) [70-4210](#) [70-4226B](#)
[70-4853B](#) [707-5020](#) [707-5028](#) [71.350.2428.0](#) [71961-016LF](#) [733-134](#) [754199-000](#) [760-3052](#) [787-8014-00](#) [FCN-367T-T012/H](#) [80.063.4001.1](#)
[800-90-001-10-001000](#) [800-90-010-10-002000](#) [801-43-002-10-013000](#) [801-43-006-10-002000](#) [803-41-018-10-001000](#) [803-43-014-20-](#)
[001000](#)