

Specifications

Current rating:3A AC,DC
Voltage rating:250V AC,DC
Temperature range:-40°C~+105°C
Contact resistance:10mΩMax.
Insulation resistance:1000MΩMin.
Withstanding voltage:800V AC/minute
Compliant with RoHS and REACH
Meet the HF/Halogen Free,need to customize
Contact CJT for details

Standards



Assembly layout

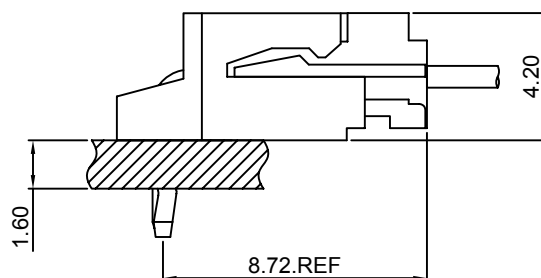
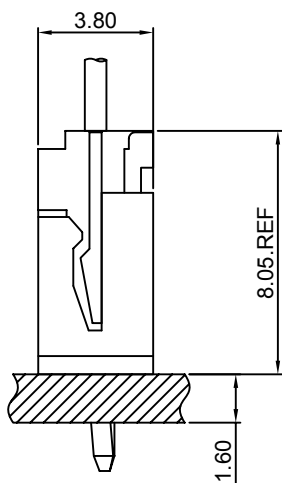

A2502-T

2.50mm pitch Crimp Terminal

Reference Informations:

*Used in CJT A2502 series Housing

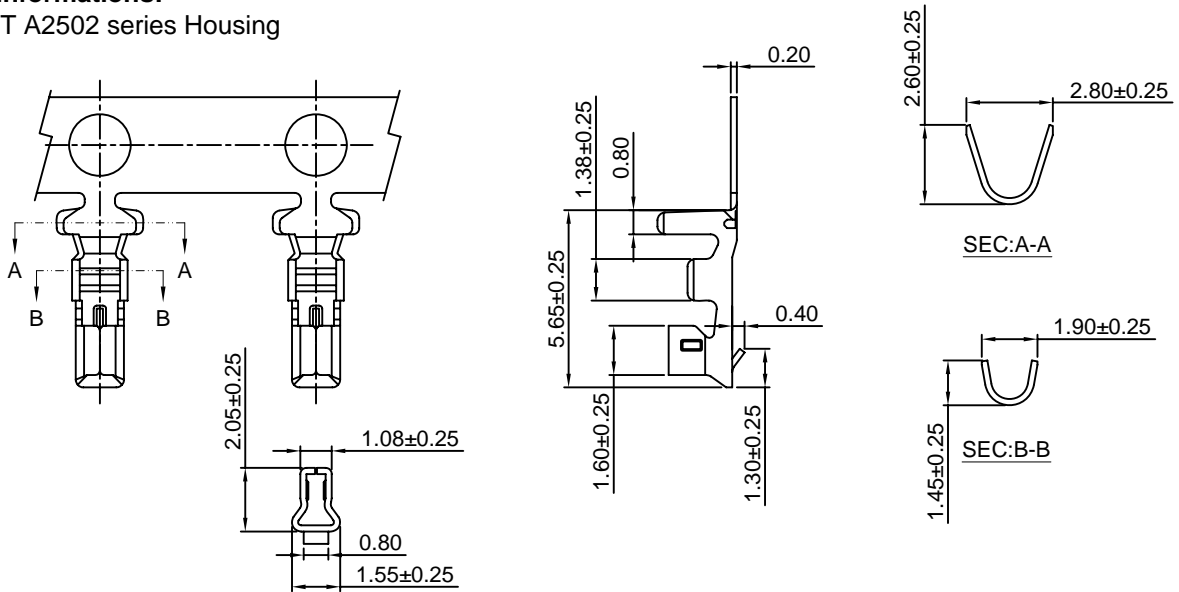

Ordering information & Specifications

Unit:mm

Part NO	Wire Range	Insulation O.D.	Material	Finish	Qty/reel
A2502-TP	AWG#22-#30	1.90mm(max)	Phosphor Bronze	Tin over Nickel	10,000 PCS
A2502-GP	AWG#22-#30	1.90mm(max)	Phosphor Bronze	Gold over Nickel	10,000 PCS

Optional Gold plating available but MOQ requested

A2502H

2.50mm pitch Housing

Reference Informations:

*Material:Nylon 66,UL94V-0

*Suitable CJT A2502 series Terminal

*Mates with CJT A2502 series Wafer

*Color:White

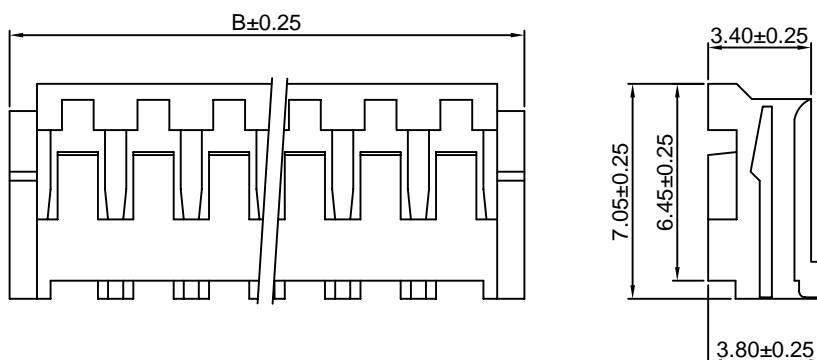
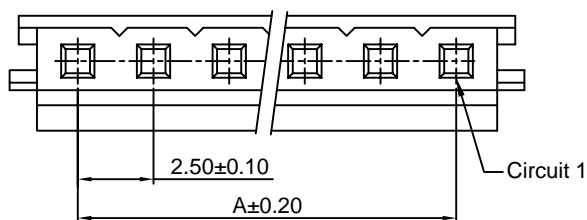
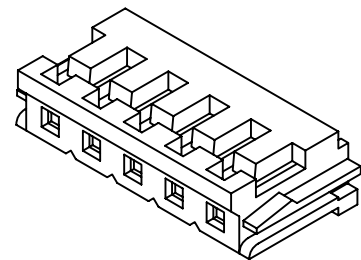

Ordering Information & Dimensions

PART NO.	Dimensions	
	A	B
A2502H-2P	2.50	7.00
A2502H-3P	5.00	9.50
A2502H-4P	7.50	12.00
A2502H-5P	10.00	14.50
A2502H-6P	12.50	17.00
A2502H-7P	15.00	19.50
A2502H-8P	17.50	22.00
A2502H-9P	20.00	24.50
A2502H-10P	22.50	27.00
A2502H-11P	25.00	29.50
A2502H-12P	27.50	32.00
A2502H-13P	30.00	34.50
A2502H-14P	32.50	37.00
A2502H-15P	35.00	39.50

Unit: mm

A2502WV

2.50mm pitch 180° Wafer

Reference Informations:

- *Material:Pin:Brass/Tin over Nickel
Insulator:Nylon 66,UL94V-0
- *Mates with CJT A2502 series Housing
- *Color:White

Ordering Information:

- A2502WV-XP - **
1 2
- 1.Part No.
 - 2.Style
(blank)-Type 1
2-Type 2

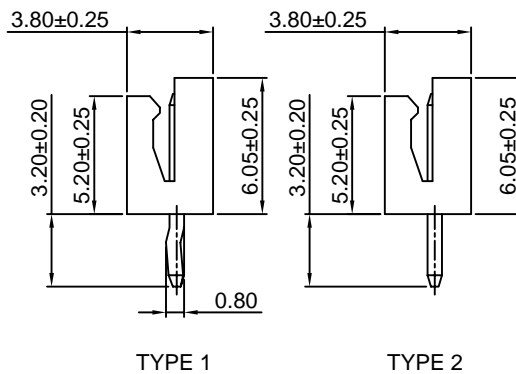
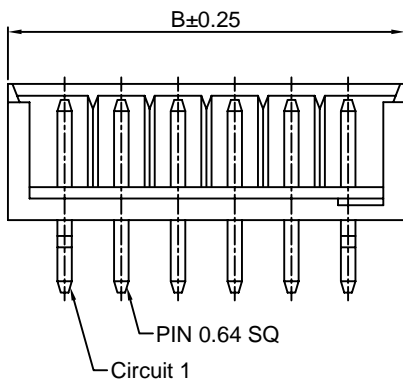
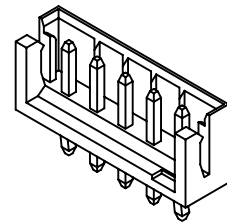
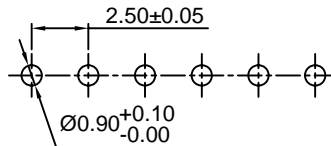
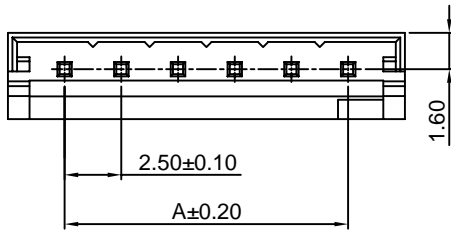

Ordering Information & Dimensions

PART NO.	Dimensions	
	A	B
A2502WV-2P	2.50	7.50
A2502WV-3P	5.00	10.00
A2502WV-4P	7.50	12.50
A2502WV-5P	10.00	15.00
A2502WV-6P	12.50	17.50
A2502WV-7P	15.00	20.00
A2502WV-8P	17.50	22.50
A2502WV-9P	20.00	25.00
A2502WV-10P	22.50	27.50
A2502WV-11P	25.00	30.00
A2502WV-12P	27.50	32.50
A2502WV-13P	30.00	35.00
A2502WV-14P	32.50	37.50
A2502WV-15P	35.00	40.00

Unit: mm

A2502WR

2.50mm pitch 90° Wafer

Reference Informations:

- *Material:Pin:Brass/Tin over Nickel
Insulator:Nylon 66,UL94V-0
- *Mates with CJT A2502 series Housing
- *Color:White

Ordering Information:

- A2502WR-XP - **
1 2
- 1.Part No.
 - 2.Style
(blank)-Type 1
2-Type 2

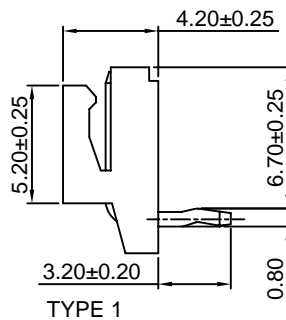
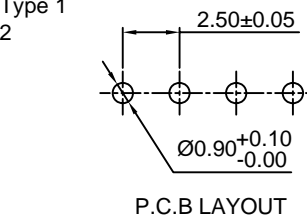
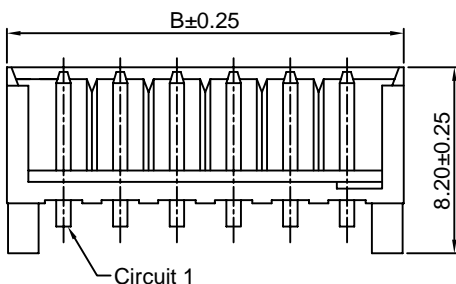
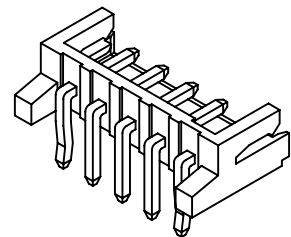
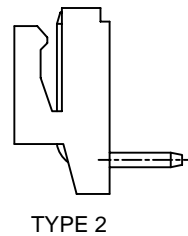
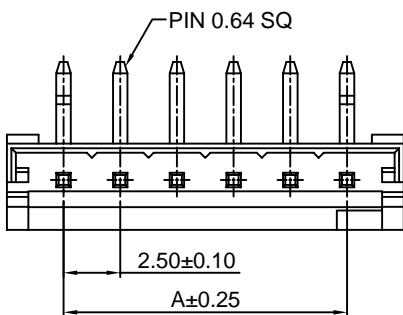

Ordering Information & Dimensions

PART NO.	Dimensions	
	A	B
A2502WR-2P	2.50	7.50
A2502WR-3P	5.00	10.00
A2502WR-4P	7.50	12.50
A2502WR-5P	10.00	15.00
A2502WR-6P	12.50	17.50
A2502WR-7P	15.00	20.00
A2502WR-8P	17.50	22.50
A2502WR-9P	20.00	25.00
A2502WR-10P	22.50	27.50
A2502WR-11P	25.00	30.00
A2502WR-12P	27.50	32.50
A2502WR-13P	30.00	35.00
A2502WR-14P	32.50	37.50
A2502WR-15P	35.00	40.00

Unit: mm

X-ON Electronics

Largest Supplier of Electrical and Electronic Components

Click to view similar products for [Headers & Wire Housings](#) category:

Click to view products by [Changjiang](#) manufacturer:

Other Similar products are found below :

[57102-F02-18ULF](#) [58102-G61-06LF](#) [0009485154](#) [009176003701906](#) [0050291907](#) [02.125.8002.8](#) [609-3404](#) [61062-3](#) [622-0430](#) [622-3653LF](#)
[63453-116](#) [636-1030](#) [636-1427](#) [636-3427](#) [636-4007](#) [641938-9](#) [644827-2](#) [65495-038](#) [65692-001LF](#) [65781-018](#) [65781-047](#) [65817-010LF](#)
[65817-015LF](#) [66207-023LF](#) [67016-026LF](#) [67095-007LF](#) [68631-112](#) [68645-018](#) [68648-049](#) [699319-000](#) [70.362.1628.0](#) [70-4210](#) [70-4226B](#)
[70-4853B](#) [707-5020](#) [707-5028](#) [71.350.2428.0](#) [71961-016LF](#) [733-134](#) [754199-000](#) [760-3052](#) [787-8014-00](#) [FCN-367T-T012/H](#) [80.063.4001.1](#)
[800-90-001-10-001000](#) [800-90-010-10-002000](#) [801-43-002-10-013000](#) [801-43-006-10-002000](#) [803-41-018-10-001000](#) [803-43-014-20-](#)
[001000](#)