

## Specifications

Current rating:3A AC,DC  
Voltage rating:250V AC,DC  
Temperature range:-40°C~+105°C  
Contact resistance:10mΩMax.  
Insulation resistance:1000MΩMin.  
Withstanding voltage:800V AC/minute  
\*Compliant with RoHS and REACH\*  
\*Meet the HF/Halogen Free,need to customize\*  
\*Contact CJT for details\*

Standards



## Assembly layout

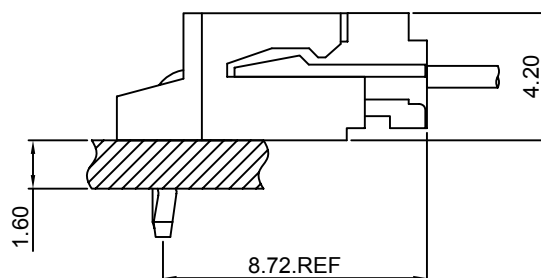
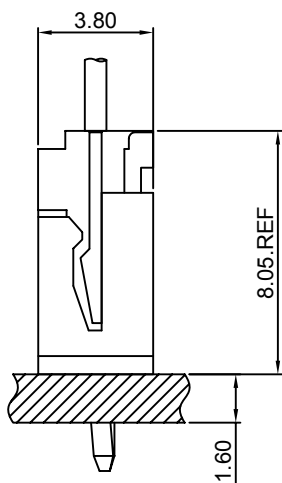

## A2502-T

2.50mm pitch Crimp Terminal

### Reference Informations:

\*Used in CJT A2502 series Housing

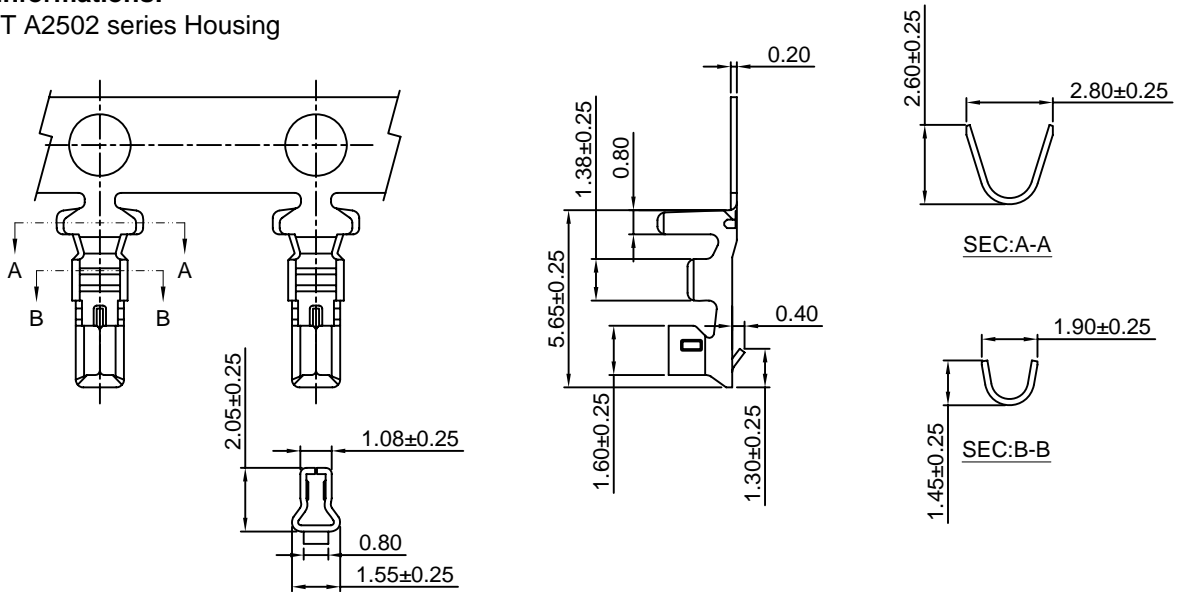

### Ordering information & Specifications

Unit:mm

| Part NO  | Wire Range | Insulation O.D. | Material        | Finish           | Qty/reel   |
|----------|------------|-----------------|-----------------|------------------|------------|
| A2502-TP | AWG#22-#30 | 1.90mm(max)     | Phosphor Bronze | Tin over Nickel  | 10,000 PCS |
| A2502-GP | AWG#22-#30 | 1.90mm(max)     | Phosphor Bronze | Gold over Nickel | 10,000 PCS |

Optional Gold plating available but MOQ requested

## A2502H

2.50mm pitch Housing

### Reference Informations:

\*Material:Nylon 66,UL94V-0

\*Suitable CJT A2502 series Terminal

\*Mates with CJT A2502 series Wafer

\*Color:White

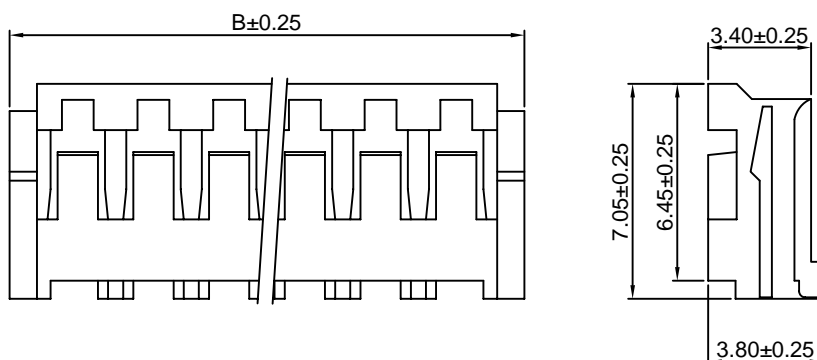
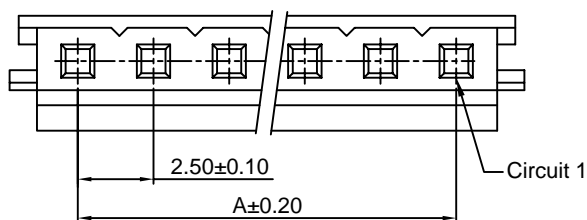
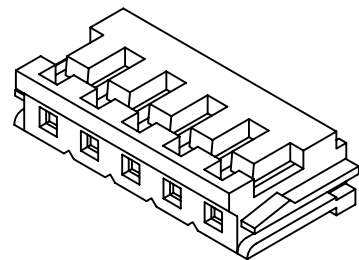

### Ordering Information & Dimensions

| PART NO.   | Dimensions |       |
|------------|------------|-------|
|            | A          | B     |
| A2502H-2P  | 2.50       | 7.00  |
| A2502H-3P  | 5.00       | 9.50  |
| A2502H-4P  | 7.50       | 12.00 |
| A2502H-5P  | 10.00      | 14.50 |
| A2502H-6P  | 12.50      | 17.00 |
| A2502H-7P  | 15.00      | 19.50 |
| A2502H-8P  | 17.50      | 22.00 |
| A2502H-9P  | 20.00      | 24.50 |
| A2502H-10P | 22.50      | 27.00 |
| A2502H-11P | 25.00      | 29.50 |
| A2502H-12P | 27.50      | 32.00 |
| A2502H-13P | 30.00      | 34.50 |
| A2502H-14P | 32.50      | 37.00 |
| A2502H-15P | 35.00      | 39.50 |

Unit: mm

### A2502WV

2.50mm pitch 180° Wafer

#### Reference Informations:

- \*Material:Pin:Brass/Tin over Nickel  
Insulator:Nylon 66,UL94V-0
- \*Mates with CJT A2502 series Housing
- \*Color:White

#### Ordering Information:

- A2502WV-XP - \*\*  
1                    2
- 1.Part No.
  - 2.Style  
(blank)-Type 1  
2-Type 2

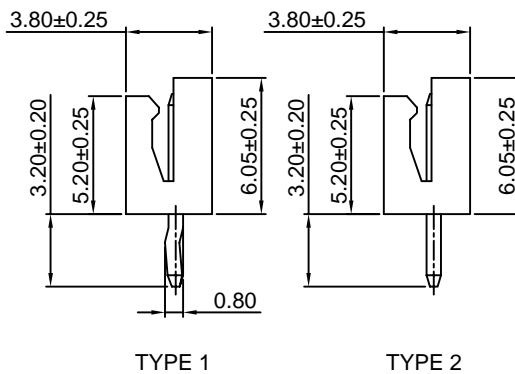
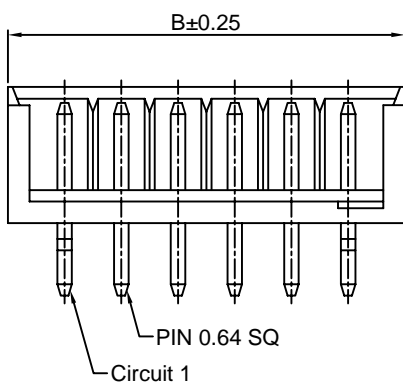
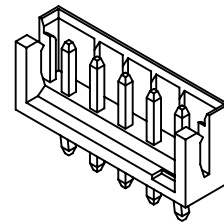
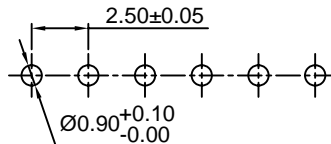
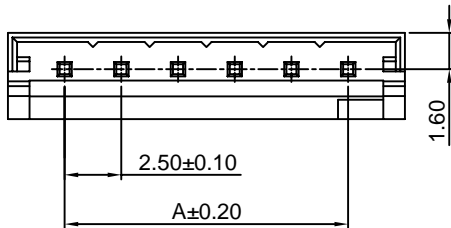

#### Ordering Information & Dimensions

| PART NO.    | Dimensions |       |
|-------------|------------|-------|
|             | A          | B     |
| A2502WV-2P  | 2.50       | 7.50  |
| A2502WV-3P  | 5.00       | 10.00 |
| A2502WV-4P  | 7.50       | 12.50 |
| A2502WV-5P  | 10.00      | 15.00 |
| A2502WV-6P  | 12.50      | 17.50 |
| A2502WV-7P  | 15.00      | 20.00 |
| A2502WV-8P  | 17.50      | 22.50 |
| A2502WV-9P  | 20.00      | 25.00 |
| A2502WV-10P | 22.50      | 27.50 |
| A2502WV-11P | 25.00      | 30.00 |
| A2502WV-12P | 27.50      | 32.50 |
| A2502WV-13P | 30.00      | 35.00 |
| A2502WV-14P | 32.50      | 37.50 |
| A2502WV-15P | 35.00      | 40.00 |

Unit: mm

### A2502WR

2.50mm pitch 90° Wafer

#### Reference Informations:

- \*Material:Pin:Brass/Tin over Nickel  
Insulator:Nylon 66,UL94V-0
- \*Mates with CJT A2502 series Housing
- \*Color:White

#### Ordering Information:

- A2502WR-XP - \*\*  
1                    2
- 1.Part No.
  - 2.Style  
(blank)-Type 1  
2-Type 2

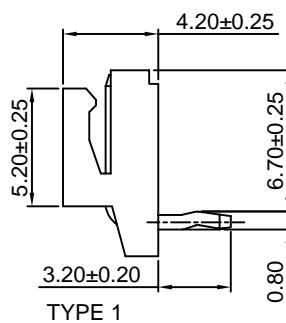
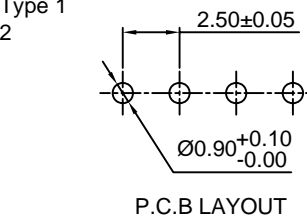
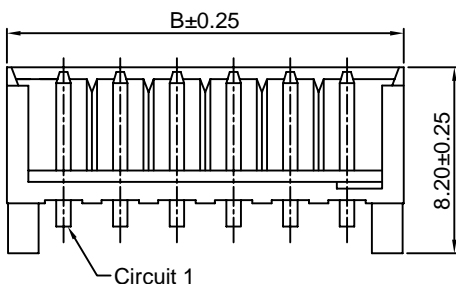
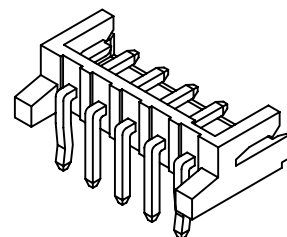
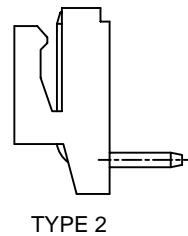
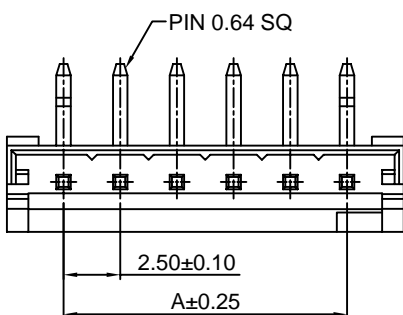

#### Ordering Information & Dimensions

| PART NO.    | Dimensions |       |
|-------------|------------|-------|
|             | A          | B     |
| A2502WR-2P  | 2.50       | 7.50  |
| A2502WR-3P  | 5.00       | 10.00 |
| A2502WR-4P  | 7.50       | 12.50 |
| A2502WR-5P  | 10.00      | 15.00 |
| A2502WR-6P  | 12.50      | 17.50 |
| A2502WR-7P  | 15.00      | 20.00 |
| A2502WR-8P  | 17.50      | 22.50 |
| A2502WR-9P  | 20.00      | 25.00 |
| A2502WR-10P | 22.50      | 27.50 |
| A2502WR-11P | 25.00      | 30.00 |
| A2502WR-12P | 27.50      | 32.50 |
| A2502WR-13P | 30.00      | 35.00 |
| A2502WR-14P | 32.50      | 37.50 |
| A2502WR-15P | 35.00      | 40.00 |

Unit: mm

## X-ON Electronics

Largest Supplier of Electrical and Electronic Components

*Click to view similar products for [Headers & Wire Housings](#) category:*

*Click to view products by [Changjiang](#) manufacturer:*

Other Similar products are found below :

[57102-F02-18ULF](#) [58102-G61-06LF](#) [0009485154](#) [009176003701906](#) [0050291907](#) [00-9021-0611-00-339](#) [02.125.8002.8](#) [609-3404](#) [61062-3](#)  
[622-0430](#) [622-3653LF](#) [63453-116](#) [636-1030](#) [636-1427](#) [636-3427](#) [636-4007](#) [641938-9](#) [644827-2](#) [65495-038](#) [65692-001LF](#) [65781-018](#)  
[65781-047](#) [65817-010LF](#) [65817-015LF](#) [66207-023LF](#) [67016-026LF](#) [67095-007LF](#) [68631-112](#) [68645-018](#) [68648-049](#) [699319-000](#)  
[70.362.1628.0](#) [70-4210](#) [70-4226B](#) [70-4853B](#) [707-5020](#) [707-5028](#) [71.350.2428.0](#) [71961-016LF](#) [733-134](#) [754199-000](#) [760-3052](#) [787-8014-00](#)  
[FCN-367T-T012/H](#) [80.063.4001.1](#) [800-90-001-10-001000](#) [800-90-010-10-002000](#) [801-43-002-10-013000](#) [801-43-006-10-002000](#)  
[803-41-018-10-001000](#)