

## Specifications

Current rating:3A AC,DC

Voltage rating:250V AC,DC

Temperature range:-40°C~+105°C

Contact resistance:20mΩ Max.

Insulation resistance:1000MΩ Min.

Withstanding voltage:1500V AC/minute

\*Compliant with RoHS and REACH\*

\*Meet the HF/Halogen Free,need to customize\*

\*Contact CJT for details\*

## Standards



E326732



E326732

# Assembly layout

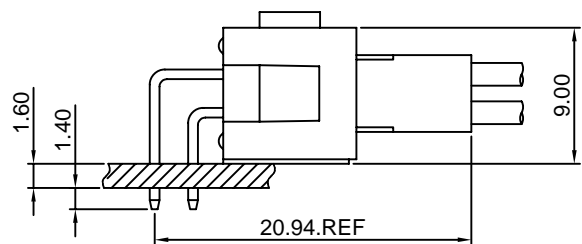
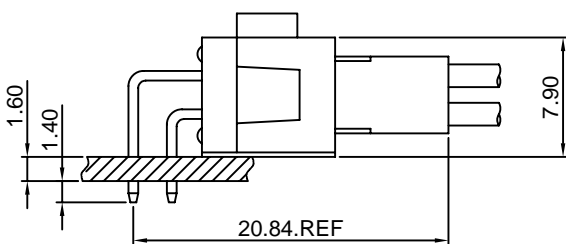
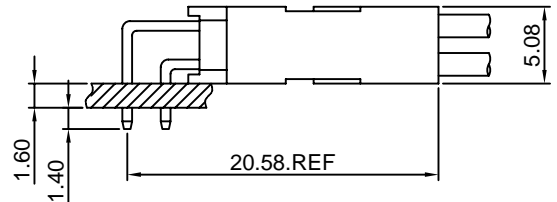
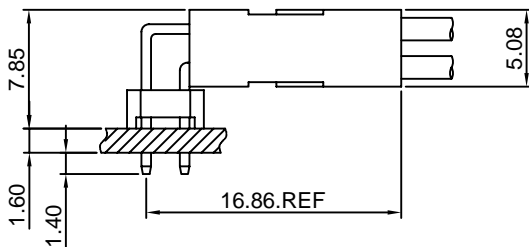
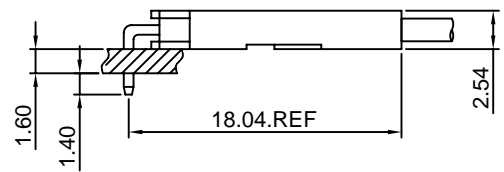
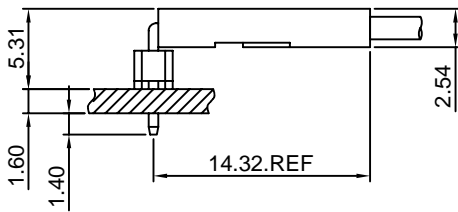
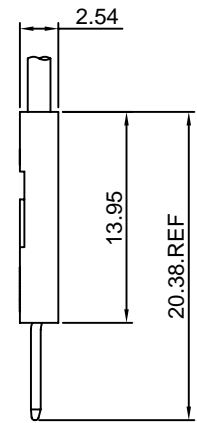
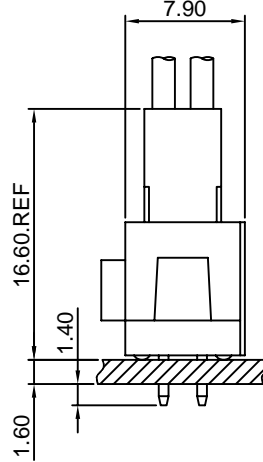
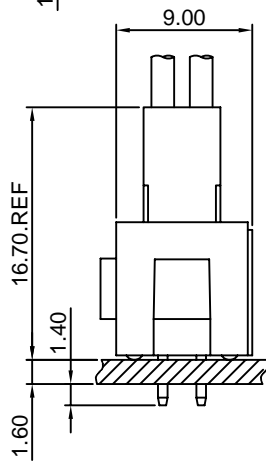
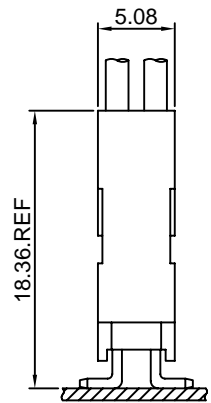
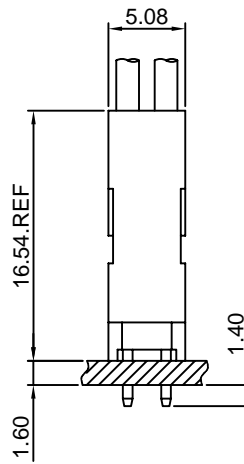
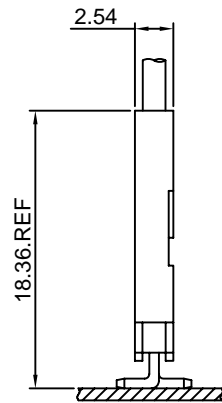
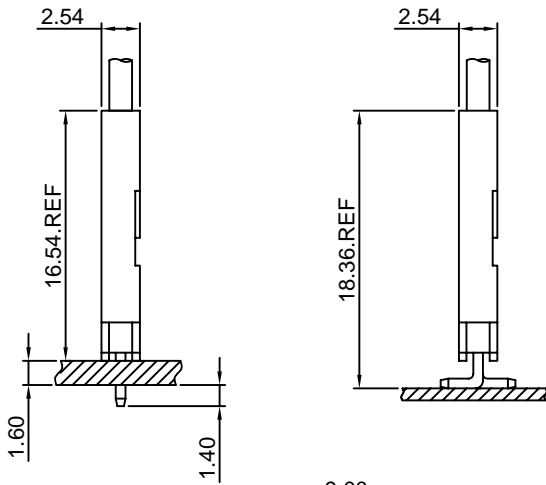

## A2541-T

2.54mm Pitch Crimp Terminal

### Reference Informations:

\*Used in CJT A2541 series Housing

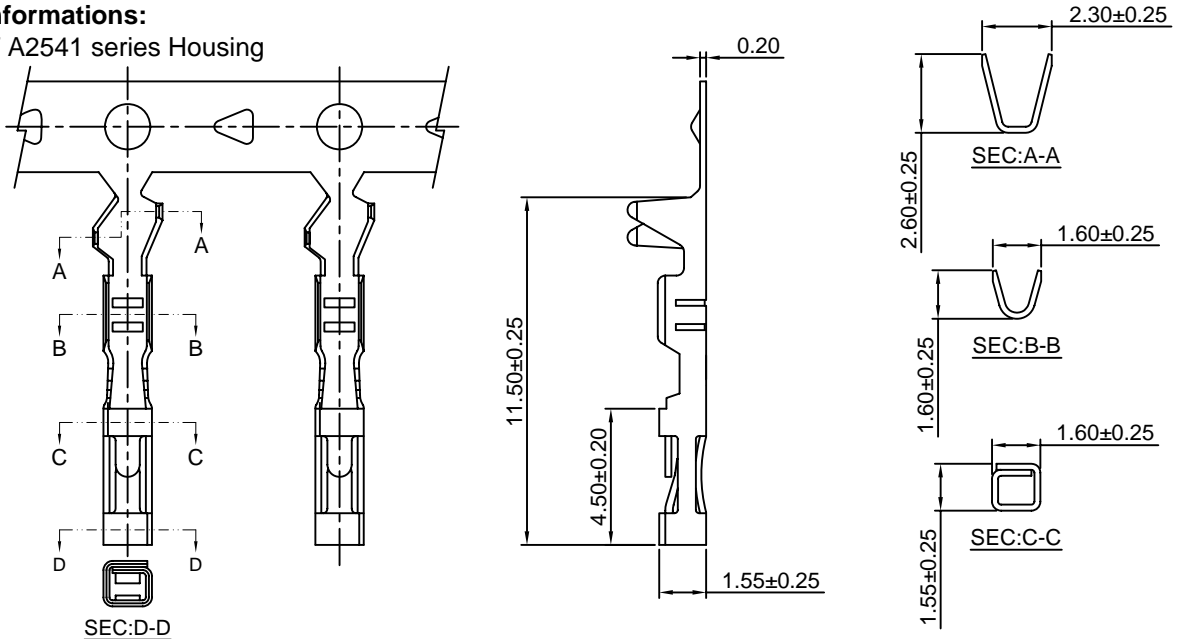

Ordering information & Specifications:

Unit:mm

Part NO.	Wire Range	Insulation O.D.	Material	Finish	Qty/reel
A2541-TB	AWG#22-#26	1.63mm(max)	Brass	Tin over Nickel	10,000 PCS
A2541-TP	AWG#22-#26	1.63mm(max)	Phosphor Bronze	Tin over Nickel	10,000 PCS
A2541-GB	AWG#22-#26	1.63mm(max)	Brass	Gold over Nickel	10,000 PCS
A2541-GP	AWG#22-#26	1.63mm(max)	Phosphor Bronze	Gold over Nickel	10,000 PCS

Optional Gold plating available but MOQ requested

## A2541M-T

2.54mm Pitch Crimp Terminal

### Reference Informations:

\*Used in CJT A2541 series Housing

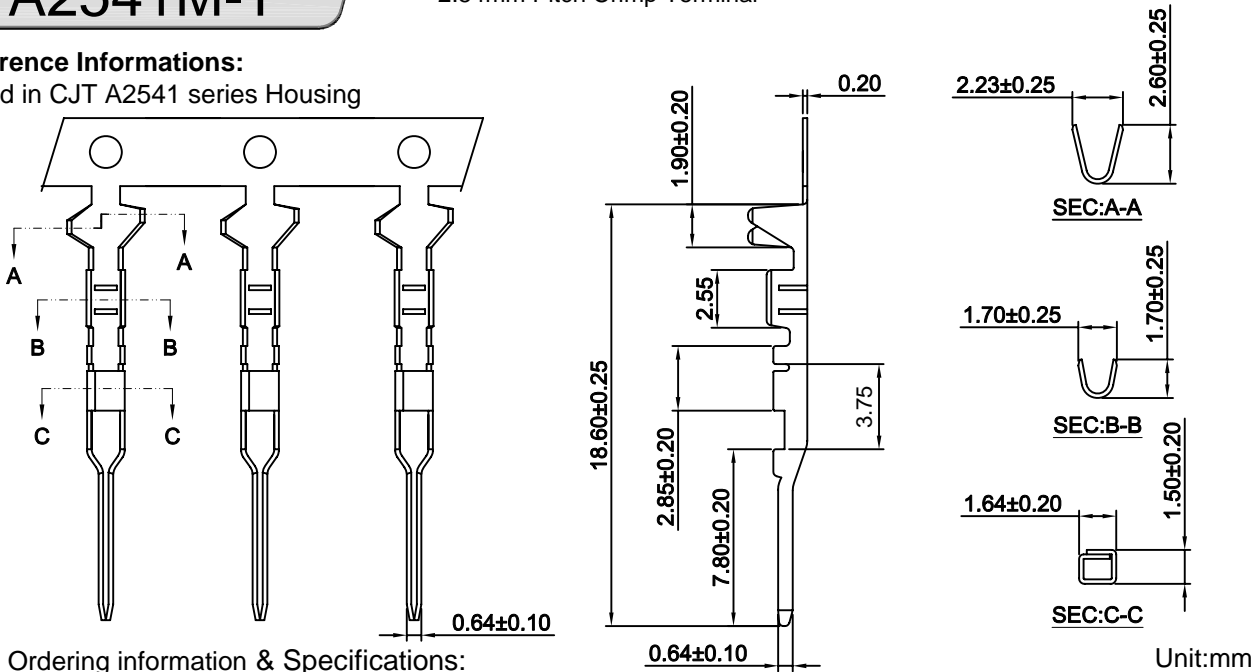

Ordering information & Specifications:

Unit:mm

Part NO	Wire Range	Insulation O.D.	Material	Finish	Qty/reel
A2541M-TB	AWG#22-#26	1.63mm(max)	Brass	Tin over Nickel	10,000 PCS
A2541M-TP	AWG#22-#26	1.63mm(max)	Phosphor Bronze	Tin over Nickel	10,000 PCS
A2541M-GB	AWG#22-#26	1.63mm(max)	Brass	Gold over Nickel	10,000 PCS
A2541M-GP	AWG#22-#26	1.63mm(max)	Phosphor Bronze	Gold over Nickel	10,000 PCS

Optional Gold plating available but MOQ requested

### A2541H

2.54mm Pitch Single Row Housing

**Reference Informations:**

- \*Material:PBT,UL94V-0
- \*Suitable CJT A2541 series Terminal or A2541M series Terminal
- \*Mates with CJT A2541 series Single row Pin Header
- \*Color:Black

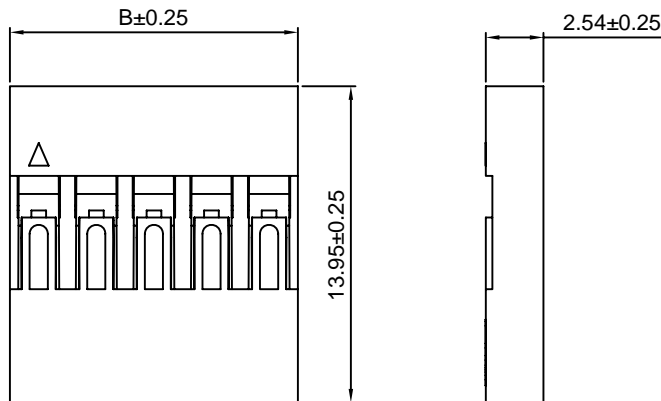
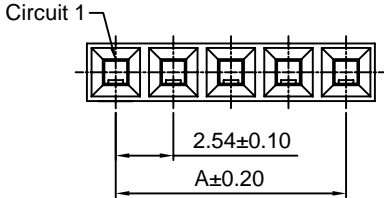
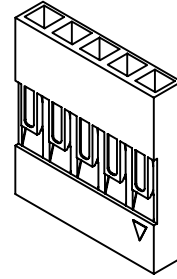

**Ordering Information & Dimensions:**

PART NO.	Dimensions		PART NO.	Dimensions	
	A	B		A	B
A2541H-1P	-----	2.54	A2541H-21P	50.80	53.34
A2541H-2P	2.54	5.08	A2541H-22P	53.34	55.88
A2541H-3P	5.08	7.62	A2541H-23P	55.88	58.42
A2541H-4P	7.62	10.16	A2541H-24P	58.42	60.96
A2541H-5P	10.16	12.70	A2541H-25P	60.96	63.50
A2541H-6P	12.70	15.24	A2541H-26P	63.50	66.04
A2541H-7P	15.24	17.78	A2541H-27P	66.04	68.58
A2541H-8P	17.78	20.32	A2541H-28P	68.58	71.12
A2541H-9P	20.32	22.86	A2541H-29P	71.12	73.66
A2541H-10P	22.86	25.40	A2541H-30P	73.66	76.20
A2541H-11P	25.40	27.94	A2541H-31P	76.20	78.74
A2541H-12P	27.94	30.48	A2541H-32P	78.74	81.28
A2541H-13P	30.48	33.02	A2541H-33P	81.28	83.82
A2541H-14P	33.02	35.56	A2541H-34P	83.82	86.36
A2541H-15P	35.56	38.10	A2541H-35P	86.36	88.90
A2541H-16P	38.10	40.64	A2541H-36P	88.90	91.44
A2541H-17P	40.64	43.18	A2541H-37P	91.44	93.98
A2541H-18P	43.18	45.72	A2541H-38P	93.98	96.52
A2541H-19P	45.72	48.26	A2541H-39P	96.52	99.06
A2541H-20P	48.26	50.80	A2541H-40P	99.06	101.60

Unit: mm

### A2541H-N

2.54mm Pitch Single Row Housing

**Reference Informations:**

- \*Material:PBT,UL94V-0
- \*Suitable CJT A2541 series Terminal
- \*Mates with CJT A2541 series Single row Pin Header
- \*Color:Black

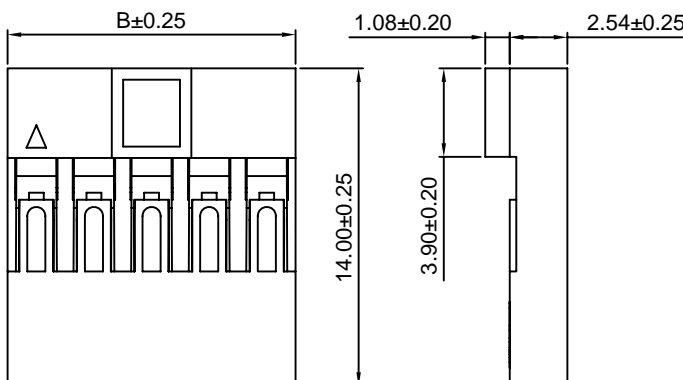
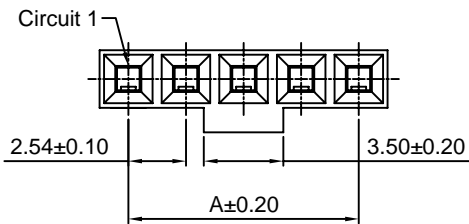
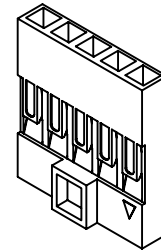

**Ordering Information & Dimensions:**

PART NO.	Dimensions		PART NO.	Dimensions	
	A	B		A	B
A2541H-N-2P	2.54	5.14	A2541H-N-22P	53.34	55.88
A2541H-N-3P	5.08	7.68	A2541H-N-23P	55.88	58.42
A2541H-N-4P	7.62	10.22	A2541H-N-24P	58.42	60.96
A2541H-N-5P	10.16	12.76	A2541H-N-25P	60.96	63.50
A2541H-N-6P	12.70	15.30	A2541H-N-26P	63.50	66.04
A2541H-N-7P	15.24	17.84	A2541H-N-27P	66.04	68.58
A2541H-N-8P	17.78	20.38	A2541H-N-28P	68.58	71.12
A2541H-N-9P	20.32	22.92	A2541H-N-29P	71.12	73.66
A2541H-N-10P	22.86	25.46	A2541H-N-30P	73.66	76.20
A2541H-N-11P	25.40	28.00	A2541H-N-31P	76.20	78.74
A2541H-N-12P	27.94	30.54	A2541H-N-32P	78.74	81.28
A2541H-N-13P	30.48	33.08	A2541H-N-33P	81.28	83.82
A2541H-N-14P	33.02	35.62	A2541H-N-34P	83.82	86.36
A2541H-N-15P	35.56	38.16	A2541H-N-35P	86.36	88.90
A2541H-N-16P	38.10	40.72	A2541H-N-36P	88.90	91.44
A2541H-N-17P	40.64	43.24	A2541H-N-37P	91.44	93.98
A2541H-N-18P	43.18	45.78	A2541H-N-38P	93.98	96.52
A2541H-N-19P	45.72	48.34	A2541H-N-39P	96.52	99.06
A2541H-N-20P	48.26	50.88	A2541H-N-40P	99.06	101.60
A2541H-N-21P	50.80	53.34			

Unit: mm

### A2541H-N-2

2.54mm Pitch Single Row Housing

**Reference Informations:**

- \*Material:PBT,UL94V-0
- \*Suitable CJT A2541 series Terminal
- \*Mates with CJT A2541 series Single row Pin Header
- \*Color:Black

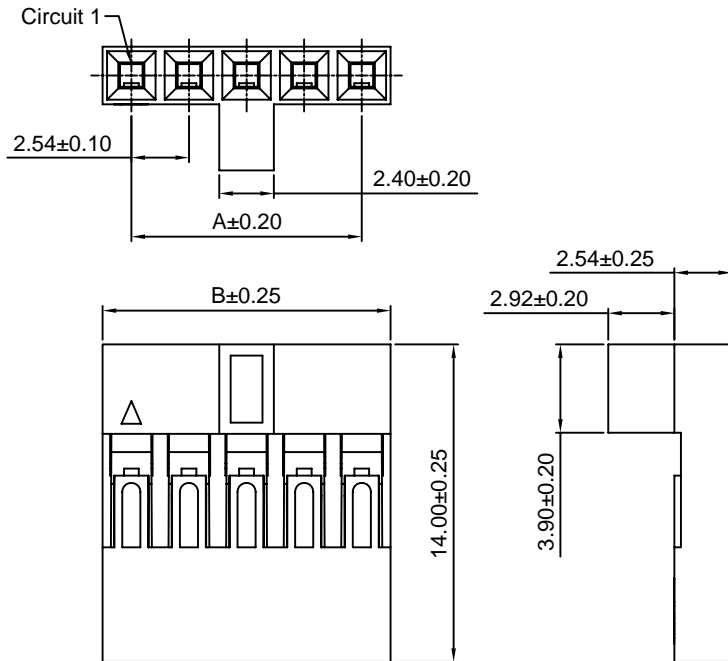
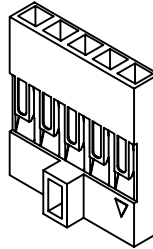

**Ordering Information & Dimensions:**

PART NO.	Dimensions		PART NO.	Dimensions	
	A	B		A	B
A2541H-N-2P-2	2.54	5.14	A2541H-N-22P-2	53.34	55.88
A2541H-N-3P-2	5.08	7.68	A2541H-N-23P-2	55.88	58.42
A2541H-N-4P-2	7.62	10.22	A2541H-N-24P-2	58.42	60.96
A2541H-N-5P-2	10.16	12.76	A2541H-N-25P-2	60.96	63.50
A2541H-N-6P-2	12.70	15.30	A2541H-N-26P-2	63.50	66.04
A2541H-N-7P-2	15.24	17.84	A2541H-N-27P-2	66.04	68.58
A2541H-N-8P-2	17.78	20.38	A2541H-N-28P-2	68.58	71.12
A2541H-N-9P-2	20.32	22.92	A2541H-N-29P-2	71.12	73.66
A2541H-N-10P-2	22.86	25.46	A2541H-N-30P-2	73.66	76.20
A2541H-N-11P-2	25.40	28.00	A2541H-N-31P-2	76.20	78.74
A2541H-N-12P-2	27.94	30.54	A2541H-N-32P-2	78.74	81.28
A2541H-N-13P-2	30.48	33.08	A2541H-N-33P-2	81.28	83.82
A2541H-N-14P-2	33.02	35.62	A2541H-N-34P-2	83.82	86.36
A2541H-N-15P-2	35.56	38.16	A2541H-N-35P-2	86.36	88.90
A2541H-N-16P-2	38.10	40.72	A2541H-N-36P-2	88.90	91.44
A2541H-N-17P-2	40.64	43.24	A2541H-N-37P-2	91.44	93.98
A2541H-N-18P-2	43.18	45.78	A2541H-N-38P-2	93.98	96.52
A2541H-N-19P-2	45.72	48.34	A2541H-N-39P-2	96.52	99.06
A2541H-N-20P-2	48.26	50.88	A2541H-N-40P-2	99.06	101.60
A2541H-N-21P-2	50.80	53.34			

Unit: mm

### A2541WV

2.54mm Pitch 180° Single Row Pin Header

**Reference Informations:**

- \*Material:Pin:Brass/Gold over Nickel  
Insulator:PBT30%GF,UL94V-0
- \*Mates with CJT A2541 series Single row Housing  
Optional Gold plating available but MOQ requested
- \*Color:Black

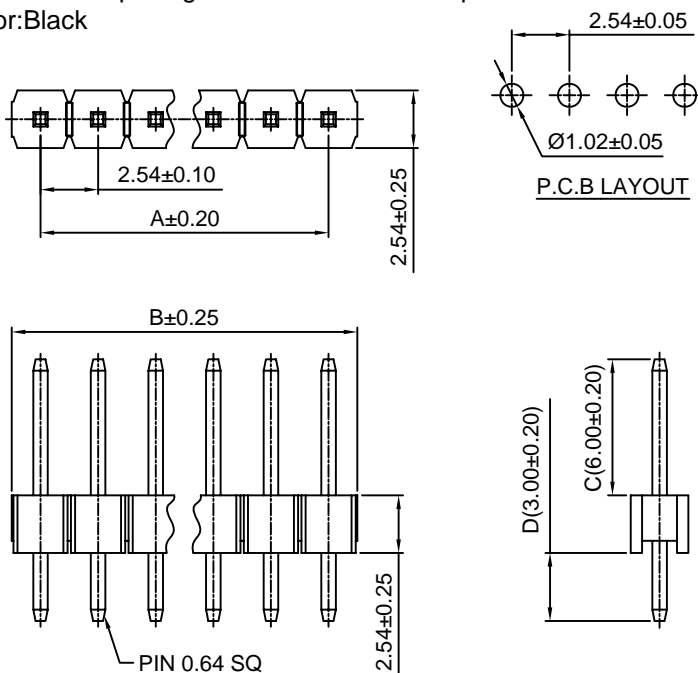
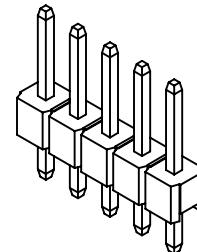

**Ordering Information & Dimensions:**

PART NO.	Dimensions		PART NO.	Dimensions	
	A	B		A	B
A2541WV-2P	2.54	5.08	A2541WV-22P	53.34	55.88
A2541WV-3P	5.08	7.62	A2541WV-23P	55.88	58.42
A2541WV-4P	7.62	10.16	A2541WV-24P	58.42	60.96
A2541WV-5P	10.16	12.70	A2541WV-25P	60.96	63.50
A2541WV-6P	12.70	15.24	A2541WV-26P	63.50	66.04
A2541WV-7P	15.24	17.78	A2541WV-27P	66.04	68.58
A2541WV-8P	17.78	20.32	A2541WV-28P	68.58	71.12
A2541WV-9P	20.32	22.86	A2541WV-29P	71.12	73.66
A2541WV-10P	22.86	25.40	A2541WV-30P	73.66	76.20
A2541WV-11P	25.40	27.94	A2541WV-31P	76.20	78.74
A2541WV-12P	27.94	30.48	A2541WV-32P	78.74	81.28
A2541WV-13P	30.48	33.02	A2541WV-33P	81.28	83.82
A2541WV-14P	33.02	35.56	A2541WV-34P	83.82	86.36
A2541WV-15P	35.56	38.10	A2541WV-35P	86.36	88.90
A2541WV-16P	38.10	40.64	A2541WV-36P	88.90	91.44
A2541WV-17P	40.64	43.18	A2541WV-37P	91.44	93.98
A2541WV-18P	43.18	45.72	A2541WV-38P	93.98	96.52
A2541WV-19P	45.72	48.26	A2541WV-39P	96.52	99.06
A2541WV-20P	48.26	50.80	A2541WV-40P	99.06	101.60
A2541WV-21P	50.80	53.34			

Unit: mm

### A2541WV-S-A

2.54mm Pitch 180° Single Row Pin Header-SMT A TYPE

#### Reference Informations:

- \*Material:Pin:Brass/Gold over Nickel  
Insulator:Nylon 6T , UL94V-0
- \*Mates with CJT A2541 series Single row Housing  
Optional Gold plating available but MOQ requested
- \*Color:Black

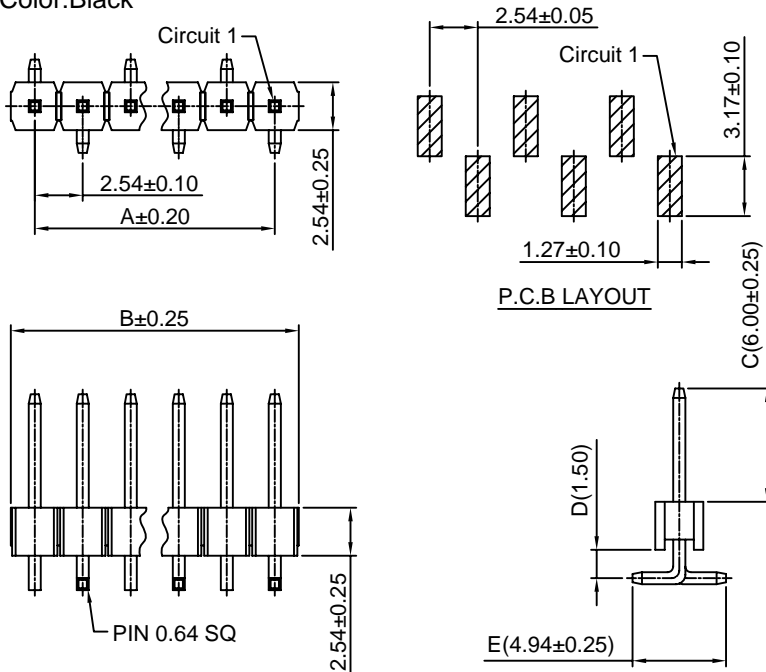
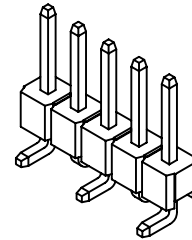

#### Ordering Information & Dimensions:

PART NO.	Dimensions		PART NO.	Dimensions	
	A	B		A	B
A2541WV-S-2P-A	2.54	5.08	A2541WV-S-22P-A	53.34	55.88
A2541WV-S-3P-A	5.08	7.62	A2541WV-S-23P-A	55.88	58.42
A2541WV-S-4P-A	7.62	10.16	A2541WV-S-24P-A	58.42	60.96
A2541WV-S-5P-A	10.16	12.70	A2541WV-S-25P-A	60.96	63.50
A2541WV-S-6P-A	12.70	15.24	A2541WV-S-26P-A	63.50	66.04
A2541WV-S-7P-A	15.24	17.78	A2541WV-S-27P-A	66.04	68.58
A2541WV-S-8P-A	17.78	20.32	A2541WV-S-28P-A	68.58	71.12
A2541WV-S-9P-A	20.32	22.86	A2541WV-S-29P-A	71.12	73.66
A2541WV-S-10P-A	22.86	25.40	A2541WV-S-30P-A	73.66	76.20
A2541WV-S-11P-A	25.40	27.94	A2541WV-S-31P-A	76.20	78.74
A2541WV-S-12P-A	27.94	30.48	A2541WV-S-32P-A	78.74	81.28
A2541WV-S-13P-A	30.48	33.02	A2541WV-S-33P-A	81.28	83.82
A2541WV-S-14P-A	33.02	35.56	A2541WV-S-34P-A	83.82	86.36
A2541WV-S-15P-A	35.56	38.10	A2541WV-S-35P-A	86.36	88.90
A2541WV-S-16P-A	38.10	40.64	A2541WV-S-36P-A	88.90	91.44
A2541WV-S-17P-A	40.64	43.18	A2541WV-S-37P-A	91.44	93.98
A2541WV-S-18P-A	43.18	45.72	A2541WV-S-38P-A	93.98	96.52
A2541WV-S-19P-A	45.72	48.26	A2541WV-S-39P-A	96.52	99.06
A2541WV-S-20P-A	48.26	50.80	A2541WV-S-40P-A	99.06	101.60
A2541WV-S-21P-A	50.80	53.34			

Unit: mm

### A2541WV-S-B

2.54mm Pitch 180° Single Row Pin Header-SMT B TYPE

#### Reference Informations:

- \*Material:Pin:Brass/Gold over Nickel  
Insulator:Nylon 6T , UL94V-0
- \*Mates with CJT A2541 series Single row Housing  
Optional Gold plating available but MOQ requested
- \*Color:Black

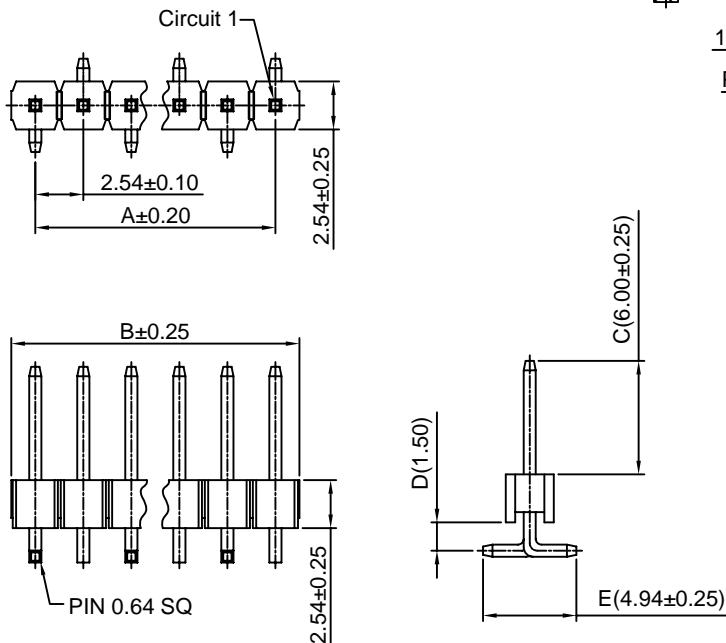

#### Ordering Information & Dimensions:

PART NO.	Dimensions		PART NO.	Dimensions	
	A	B		A	B
A2541WV-S-2P-B	2.54	5.08	A2541WV-S-22P-B	53.34	55.88
A2541WV-S-3P-B	5.08	7.62	A2541WV-S-23P-B	55.88	58.42
A2541WV-S-4P-B	7.62	10.16	A2541WV-S-24P-B	58.42	60.96
A2541WV-S-5P-B	10.16	12.70	A2541WV-S-25P-B	60.96	63.50
A2541WV-S-6P-B	12.70	15.24	A2541WV-S-26P-B	63.50	66.04
A2541WV-S-7P-B	15.24	17.78	A2541WV-S-27P-B	66.04	68.58
A2541WV-S-8P-B	17.78	20.32	A2541WV-S-28P-B	68.58	71.12
A2541WV-S-9P-B	20.32	22.86	A2541WV-S-29P-B	71.12	73.66
A2541WV-S-10P-B	22.86	25.40	A2541WV-S-30P-B	73.66	76.20
A2541WV-S-11P-B	25.40	27.94	A2541WV-S-31P-B	76.20	78.74
A2541WV-S-12P-B	27.94	30.48	A2541WV-S-32P-B	78.74	81.28
A2541WV-S-13P-B	30.48	33.02	A2541WV-S-33P-B	81.28	83.82
A2541WV-S-14P-B	33.02	35.56	A2541WV-S-34P-B	83.82	86.36
A2541WV-S-15P-B	35.56	38.10	A2541WV-S-35P-B	86.36	88.90
A2541WV-S-16P-B	38.10	40.64	A2541WV-S-36P-B	88.90	91.44
A2541WV-S-17P-B	40.64	43.18	A2541WV-S-37P-B	91.44	93.98
A2541WV-S-18P-B	43.18	45.72	A2541WV-S-38P-B	93.98	96.52
A2541WV-S-19P-B	45.72	48.26	A2541WV-S-39P-B	96.52	99.06
A2541WV-S-20P-B	48.26	50.80	A2541WV-S-40P-B	99.06	101.60
A2541WV-S-21P-B	50.80	53.34			

Unit: mm



### A2541WVA

2.54mm Pitch 180° Single Row Pin Header

#### Reference Informations:

- \*Material: Pin: Brass/Gold over Nickel  
Insulator: PBT30%GF, UL94V-0
- \*Mates with CJT A2541 series Single row Housing  
Optional Gold plating available but MOQ requested
- \*Color: Black

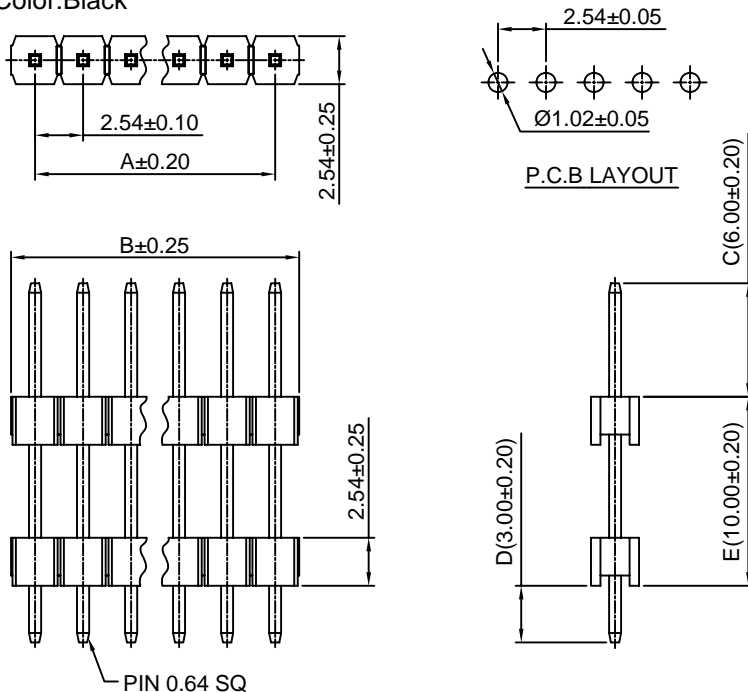
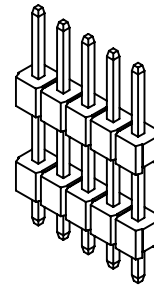

#### Ordering Information & Dimensions:

PART NO.	Dimensions		PART NO.	Dimensions	
	A	B		A	B
A2541WVA-2P	2.54	5.08	A2541WVA-22P	53.34	55.88
A2541WVA-3P	5.08	7.62	A2541WVA-23P	55.88	58.42
A2541WVA-4P	7.62	10.16	A2541WVA-24P	58.42	60.96
A2541WVA-5P	10.16	12.70	A2541WVA-25P	60.96	63.50
A2541WVA-6P	12.70	15.24	A2541WVA-26P	63.50	66.04
A2541WVA-7P	15.24	17.78	A2541WVA-27P	66.04	68.58
A2541WVA-8P	17.78	20.32	A2541WVA-28P	68.58	71.12
A2541WVA-9P	20.32	22.86	A2541WVA-29P	71.12	73.66
A2541WVA-10P	22.86	25.40	A2541WVA-30P	73.66	76.20
A2541WVA-11P	25.40	27.94	A2541WVA-31P	76.20	78.74
A2541WVA-12P	27.94	30.48	A2541WVA-32P	78.74	81.28
A2541WVA-13P	30.48	33.02	A2541WVA-33P	81.28	83.82
A2541WVA-14P	33.02	35.56	A2541WVA-34P	83.82	86.36
A2541WVA-15P	35.56	38.10	A2541WVA-35P	86.36	88.90
A2541WVA-16P	38.10	40.64	A2541WVA-36P	88.90	91.44
A2541WVA-17P	40.64	43.18	A2541WVA-37P	91.44	93.98
A2541WVA-18P	43.18	45.72	A2541WVA-38P	93.98	96.52
A2541WVA-19P	45.72	48.26	A2541WVA-39P	96.52	99.06
A2541WVA-20P	48.26	50.80	A2541WVA-40P	99.06	101.60
A2541WVA-21P	50.80	53.34			

Unit: mm

### A2541WVA-S-A

2.54mm Pitch 180° Single Row Pin Header-SMT A TYPE

#### Reference Informations:

- \*Material: Pin: Brass/Gold over Nickel  
Insulator: Nylon 6T, UL94V-0
- \*Mates with CJT A2541 series Single row Housing  
Optional Gold plating available but MOQ requested
- \*Color: Black

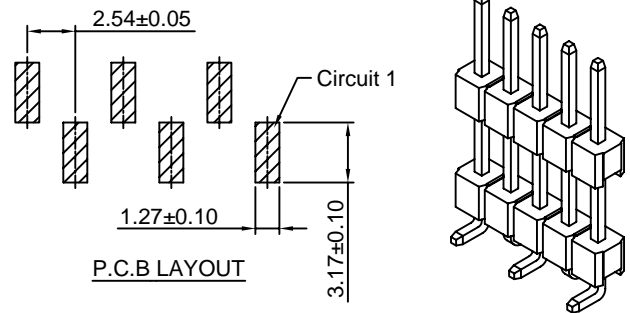

#### Ordering Information & Dimensions:

PART NO.	Dimensions		PART NO.	Dimensions	
	A	B		A	B
A2541WVA-S-2P-A	2.54	5.08	A2541WVA-S-22P-A	53.34	55.88
A2541WVA-S-3P-A	5.08	7.62	A2541WVA-S-23P-A	55.88	58.42
A2541WVA-S-4P-A	7.62	10.16	A2541WVA-S-24P-A	58.42	60.96
A2541WVA-S-5P-A	10.16	12.70	A2541WVA-S-25P-A	60.96	63.50
A2541WVA-S-6P-A	12.70	15.24	A2541WVA-S-26P-A	63.50	66.04
A2541WVA-S-7P-A	15.24	17.78	A2541WVA-S-27P-A	66.04	68.58
A2541WVA-S-8P-A	17.78	20.32	A2541WVA-S-28P-A	68.58	71.12
A2541WVA-S-9P-A	20.32	22.86	A2541WVA-S-29P-A	71.12	73.66
A2541WVA-S-10P-A	22.86	25.40	A2541WVA-S-30P-A	73.66	76.20
A2541WVA-S-11P-A	25.40	27.94	A2541WVA-S-31P-A	76.20	78.74
A2541WVA-S-12P-A	27.94	30.48	A2541WVA-S-32P-A	78.74	81.28
A2541WVA-S-13P-A	30.48	33.02	A2541WVA-S-33P-A	81.28	83.82
A2541WVA-S-14P-A	33.02	35.56	A2541WVA-S-34P-A	83.82	86.36
A2541WVA-S-15P-A	35.56	38.10	A2541WVA-S-35P-A	86.36	88.90
A2541WVA-S-16P-A	38.10	40.64	A2541WVA-S-36P-A	88.90	91.44
A2541WVA-S-17P-A	40.64	43.18	A2541WVA-S-37P-A	91.44	93.98
A2541WVA-S-18P-A	43.18	45.72	A2541WVA-S-38P-A	93.98	96.52
A2541WVA-S-19P-A	45.72	48.26	A2541WVA-S-39P-A	96.52	99.06
A2541WVA-S-20P-A	48.26	50.80	A2541WVA-S-40P-A	99.06	101.60
A2541WVA-S-21P-A	50.80	53.34			

Unit: mm

### A2541WVA-S-B

2.54mm Pitch 180° Single Row Pin Header-SMT B TYPE

#### Reference Informations:

- \*Material: Pin: Brass/Gold over Nickel  
Insulator: Nylon 6T, UL94V-0
- \*Mates with CJT A2541 series Single row Housing  
Optional Gold plating available but MOQ requested
- \*Color: Black

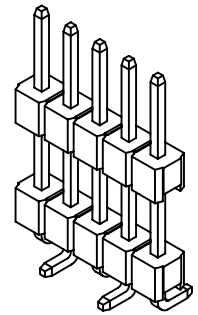
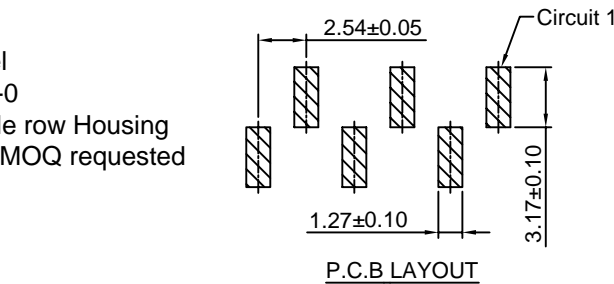
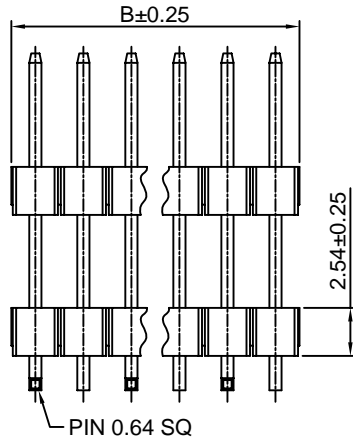
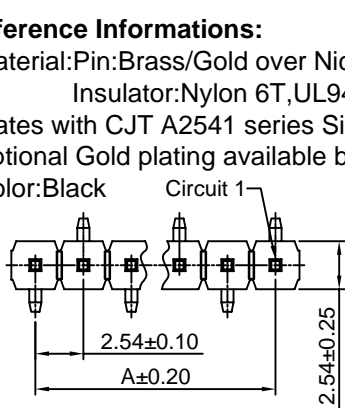

#### Ordering Information & Dimensions:

PART NO.	Dimensions		PART NO.	Dimensions	
	A	B		A	B
A2541WVA-S-2P-B	2.54	5.08	A2541WVA-S-22P-B	53.34	55.88
A2541WVA-S-3P-B	5.08	7.62	A2541WVA-S-23P-B	55.88	58.42
A2541WVA-S-4P-B	7.62	10.16	A2541WVA-S-24P-B	58.42	60.96
A2541WVA-S-5P-B	10.16	12.70	A2541WVA-S-25P-B	60.96	63.50
A2541WVA-S-6P-B	12.70	15.24	A2541WVA-S-26P-B	63.50	66.04
A2541WVA-S-7P-B	15.24	17.78	A2541WVA-S-27P-B	66.04	68.58
A2541WVA-S-8P-B	17.78	20.32	A2541WVA-S-28P-B	68.58	71.12
A2541WVA-S-9P-B	20.32	22.86	A2541WVA-S-29P-B	71.12	73.66
A2541WVA-S-10P-B	22.86	25.40	A2541WVA-S-30P-B	73.66	76.20
A2541WVA-S-11P-B	25.40	27.94	A2541WVA-S-31P-B	76.20	78.74
A2541WVA-S-12P-B	27.94	30.48	A2541WVA-S-32P-B	78.74	81.28
A2541WVA-S-13P-B	30.48	33.02	A2541WVA-S-33P-B	81.28	83.82
A2541WVA-S-14P-B	33.02	35.56	A2541WVA-S-34P-B	83.82	86.36
A2541WVA-S-15P-B	35.56	38.10	A2541WVA-S-35P-B	86.36	88.90
A2541WVA-S-16P-B	38.10	40.64	A2541WVA-S-36P-B	88.90	91.44
A2541WVA-S-17P-B	40.64	43.18	A2541WVA-S-37P-B	91.44	93.98
A2541WVA-S-18P-B	43.18	45.72	A2541WVA-S-38P-B	93.98	96.52
A2541WVA-S-19P-B	45.72	48.26	A2541WVA-S-39P-B	96.52	99.06
A2541WVA-S-20P-B	48.26	50.80	A2541WVA-S-40P-B	99.06	101.60
A2541WVA-S-21P-B	50.80	53.34			

Unit: mm

### A2541WR

2.54mm Pitch 90° Single Row Pin Header

#### Reference Informations:

- \*Material: Pin: Brass/Gold over Nickel  
Insulator: PBT30%GF, UL94V-0
- \*Mates with CJT A2541 series Single row Housing  
Optional Gold plating available but MOQ requested
- \*Color: Black

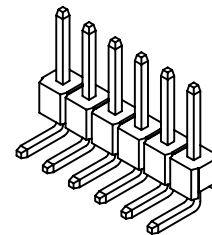
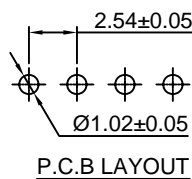
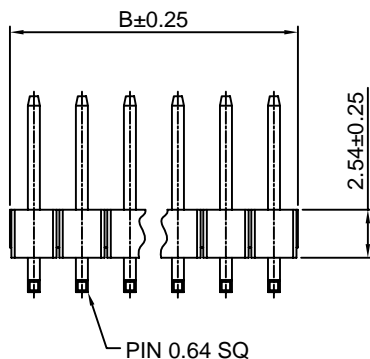
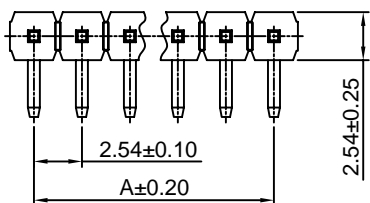

#### Ordering Information & Dimensions:

PART NO.	Dimensions		PART NO.	Dimensions	
	A	B		A	B
A2541WR-2P	2.54	5.08	A2541WR-22P	53.34	55.88
A2541WR-3P	5.08	7.62	A2541WR-23P	55.88	58.42
A2541WR-4P	7.62	10.16	A2541WR-24P	58.42	60.96
A2541WR-5P	10.16	12.70	A2541WR-25P	60.96	63.50
A2541WR-6P	12.70	15.24	A2541WR-26P	63.50	66.04
A2541WR-7P	15.24	17.78	A2541WR-27P	66.04	68.58
A2541WR-8P	17.78	20.32	A2541WR-28P	68.58	71.12
A2541WR-9P	20.32	22.86	A2541WR-29P	71.12	73.66
A2541WR-10P	22.86	25.40	A2541WR-30P	73.66	76.20
A2541WR-11P	25.40	27.94	A2541WR-31P	76.20	78.74
A2541WR-12P	27.94	30.48	A2541WR-32P	78.74	81.28
A2541WR-13P	30.48	33.02	A2541WR-33P	81.28	83.82
A2541WR-14P	33.02	35.56	A2541WR-34P	83.82	86.36
A2541WR-15P	35.56	38.10	A2541WR-35P	86.36	88.90
A2541WR-16P	38.10	40.64	A2541WR-36P	88.90	91.44
A2541WR-17P	40.64	43.18	A2541WR-37P	91.44	93.98
A2541WR-18P	43.18	45.72	A2541WR-38P	93.98	96.52
A2541WR-19P	45.72	48.26	A2541WR-39P	96.52	99.06
A2541WR-20P	48.26	50.80	A2541WR-40P	99.06	101.60
A2541WR-21P	50.80	53.34			

Unit: mm



### A2541WRA

2.54mm Pitch 90° Single Row Pin Header

**Reference Informations:**

- \*Material: Pin: Brass/Gold over Nickel  
Insulator: PBT30%GF, UL94V-0
- \*Mates with CJT A2541 series Single row Housing  
Optional Gold plating available but MOQ requested
- \*Color: Black

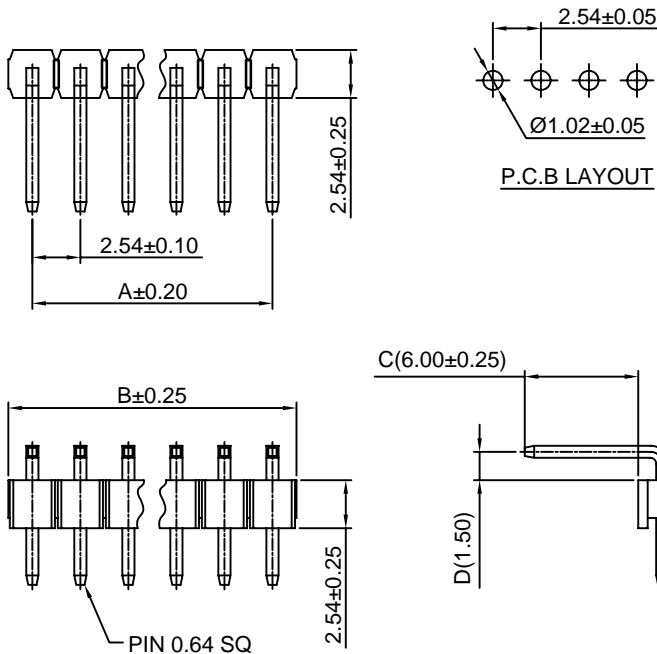
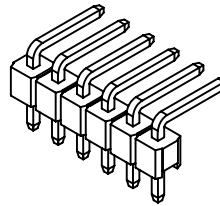

**Ordering Information & Dimensions:**

PART NO.	Dimensions		PART NO.	Dimensions	
	A	B		A	B
A2541WRA-2P	2.54	5.08	A2541WRA-22P	53.34	55.88
A2541WRA-3P	5.08	7.62	A2541WRA-23P	55.88	58.42
A2541WRA-4P	7.62	10.16	A2541WRA-24P	58.42	60.96
A2541WRA-5P	10.16	12.70	A2541WRA-25P	60.96	63.50
A2541WRA-6P	12.70	15.24	A2541WRA-26P	63.50	66.04
A2541WRA-7P	15.24	17.78	A2541WRA-27P	66.04	68.58
A2541WRA-8P	17.78	20.32	A2541WRA-28P	68.58	71.12
A2541WRA-9P	20.32	22.86	A2541WRA-29P	71.12	73.66
A2541WRA-10P	22.86	25.40	A2541WRA-30P	73.66	76.20
A2541WRA-11P	25.40	27.94	A2541WRA-31P	76.20	78.74
A2541WRA-12P	27.94	30.48	A2541WRA-32P	78.74	81.28
A2541WRA-13P	30.48	33.02	A2541WRA-33P	81.28	83.82
A2541WRA-14P	33.02	35.56	A2541WRA-34P	83.82	86.36
A2541WRA-15P	35.56	38.10	A2541WRA-35P	86.36	88.90
A2541WRA-16P	38.10	40.64	A2541WRA-36P	88.90	91.44
A2541WRA-17P	40.64	43.18	A2541WRA-37P	91.44	93.98
A2541WRA-18P	43.18	45.72	A2541WRA-38P	93.98	96.52
A2541WRA-19P	45.72	48.26	A2541WRA-39P	96.52	99.06
A2541WRA-20P	48.26	50.80	A2541WRA-40P	99.06	101.60
A2541WRA-21P	50.80	53.34			

Unit: mm

### A2541H-2

2.54mm Pitch Dual Row Housing

**Reference Informations:**

- \*Material: PBT15%GF, UL94V-0
- \*Suitable CJT A2541 series Terminal or A2541M series Terminal
- \*Mates with CJT A2541 series Dual row Pin Header
- \*Color: Black

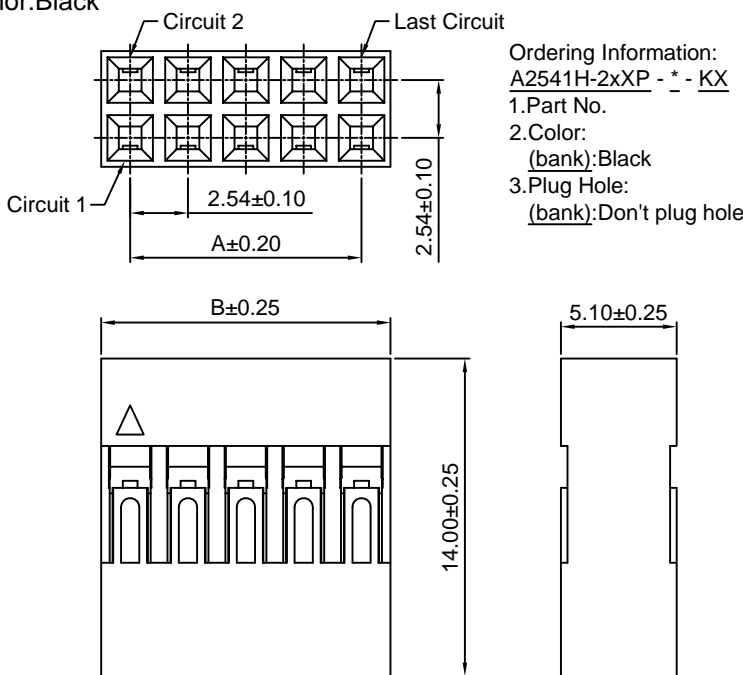
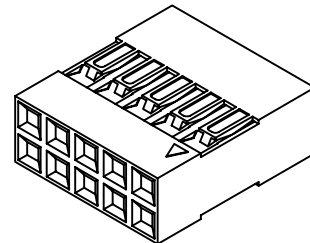

**Ordering Information & Dimensions:**

PART NO.	Dimensions		PART NO.	Dimensions	
	A	B		A	B
A2541H-2x2P	2.54	5.08	A2541H-2x22P	53.34	55.88
A2541H-2x3P	5.08	7.62	A2541H-2x23P	55.88	58.42
A2541H-2x4P	7.62	10.16	A2541H-2x24P	58.42	60.96
A2541H-2x5P	10.16	12.70	A2541H-2x25P	60.96	63.50
A2541H-2x6P	12.70	15.24	A2541H-2x26P	63.50	66.04
A2541H-2x7P	15.24	17.78	A2541H-2x27P	66.04	68.58
A2541H-2x8P	17.78	20.32	A2541H-2x28P	68.58	71.12
A2541H-2x9P	20.32	22.86	A2541H-2x29P	71.12	73.66
A2541H-2x10P	22.86	25.40	A2541H-2x30P	73.66	76.20
A2541H-2x11P	25.40	27.94	A2541H-2x31P	76.20	78.74
A2541H-2x12P	27.94	30.48	A2541H-2x32P	78.74	81.28
A2541H-2x13P	30.48	33.02	A2541H-2x33P	81.28	83.82
A2541H-2x14P	33.02	35.56	A2541H-2x34P	83.82	86.36
A2541H-2x15P	35.56	38.10	A2541H-2x35P	86.36	88.90
A2541H-2x16P	38.10	40.64	A2541H-2x36P	88.90	91.44
A2541H-2x17P	40.64	43.18	A2541H-2x37P	91.44	93.98
A2541H-2x18P	43.18	45.72	A2541H-2x38P	93.98	96.52
A2541H-2x19P	45.72	48.26	A2541H-2x39P	96.52	99.06
A2541H-2x20P	48.26	50.80	A2541H-2x40P	99.06	101.60
A2541H-2x21P	50.80	53.34			

Unit: mm

### A2541H-N-2

2.54mm Pitch Dual Row Housing

**Reference Informations:**

- \*Material:PBT15%GF,UL94V-0
- \*Suitable CJT A2541 series Terminal
- \*Mates with CJT A2541 series dual row Pin Header or A2541series dual row Box Header
- \*Color:Black

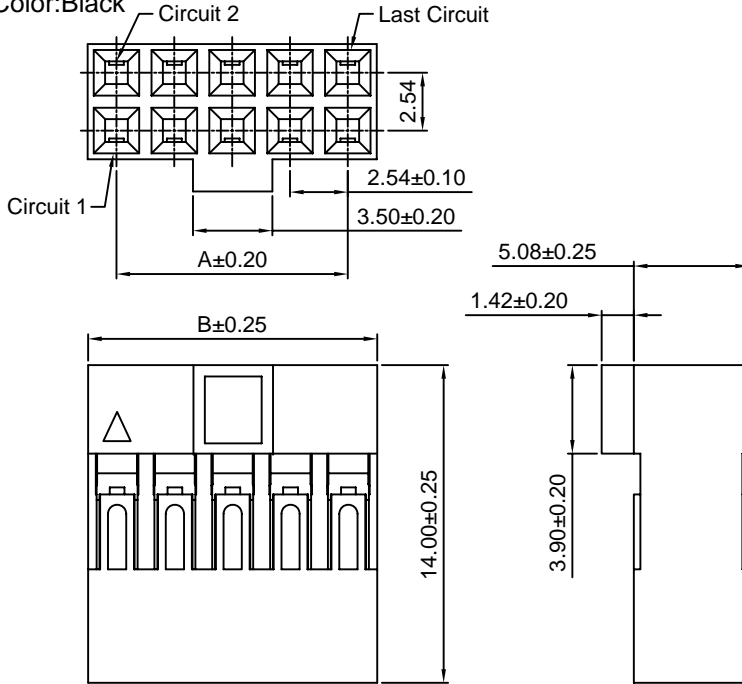
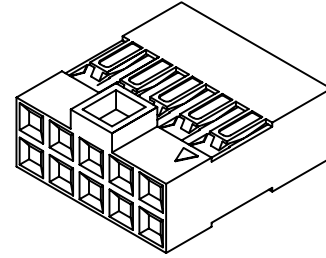

**Ordering Information & Dimensions:**

PART NO.	Dimensions		PART NO.	Dimensions	
	A	B		A	B
A2541H-N-2x2P	2.54	5.08	A2541H-N-2x22P	53.34	55.88
A2541H-N-2x3P	5.08	7.62	A2541H-N-2x23P	55.88	58.42
A2541H-N-2x4P	7.62	10.16	A2541H-N-2x24P	58.42	60.96
A2541H-N-2x5P	10.16	12.70	A2541H-N-2x25P	60.96	63.50
A2541H-N-2x6P	12.70	15.24	A2541H-N-2x26P	63.50	66.04
A2541H-N-2x7P	15.24	17.78	A2541H-N-2x27P	66.04	68.58
A2541H-N-2x8P	17.78	20.32	A2541H-N-2x28P	68.58	71.12
A2541H-N-2x9P	20.32	22.86	A2541H-N-2x29P	71.12	73.66
A2541H-N-2x10P	22.86	25.40	A2541H-N-2x30P	73.66	76.20
A2541H-N-2x11P	25.40	27.94	A2541H-N-2x31P	76.20	78.74
A2541H-N-2x12P	27.94	30.48	A2541H-N-2x32P	78.74	81.28
A2541H-N-2x13P	30.48	33.02	A2541H-N-2x33P	81.28	83.82
A2541H-N-2x14P	33.02	35.56	A2541H-N-2x34P	83.82	86.36
A2541H-N-2x15P	35.56	38.10	A2541H-N-2x35P	86.36	88.90
A2541H-N-2x16P	38.10	40.64	A2541H-N-2x36P	88.90	91.44
A2541H-N-2x17P	40.64	43.18	A2541H-N-2x37P	91.44	93.98
A2541H-N-2x18P	43.18	45.72	A2541H-N-2x38P	93.98	96.52
A2541H-N-2x19P	45.72	48.26	A2541H-N-2x39P	96.52	99.06
A2541H-N-2x20P	48.26	50.80	A2541H-N-2x40P	99.06	101.60
A2541H-N-2x21P	50.80	53.34			

Unit: mm

### A2541H-N-2-2

2.54mm Pitch Dual Row Housing

**Reference Informations:**

- \*Material:PBT15%GF,UL94V-0
- \*Suitable CJT A2541 series Terminal
- \*Mates with CJT A2541 series dual row Pin Header or A2541series dual row Box Header
- \*Color:Black

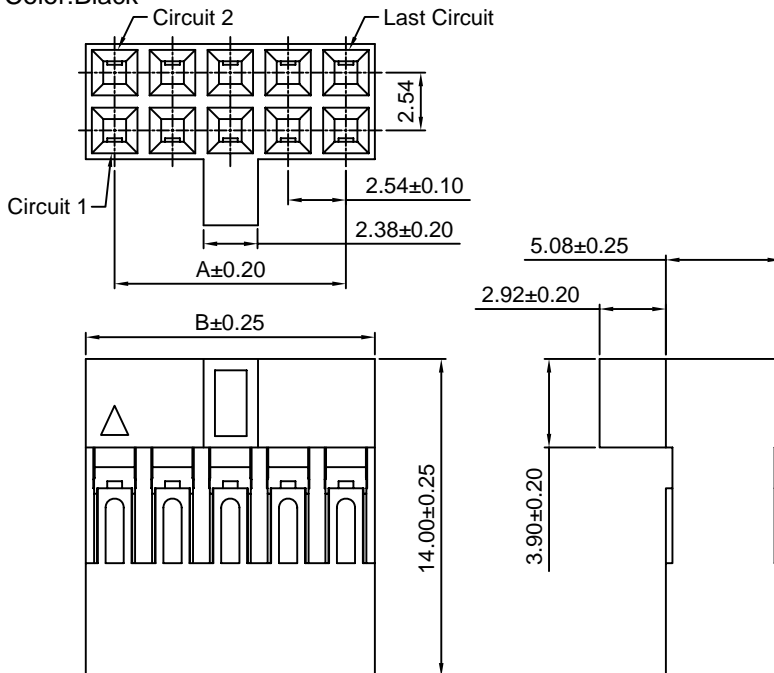
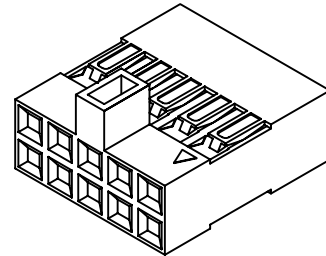

**Ordering Information & Dimensions:**

PART NO.	Dimensions		PART NO.	Dimensions	
	A	B		A	B
A2541H-N-2x2P-2	2.54	5.08	A2541H-N-2x22P-2	53.34	55.88
A2541H-N-2x3P-2	5.08	7.62	A2541H-N-2x23P-2	55.88	58.42
A2541H-N-2x4P-2	7.62	10.16	A2541H-N-2x24P-2	58.42	60.96
A2541H-N-2x5P-2	10.16	12.70	A2541H-N-2x25P-2	60.96	63.50
A2541H-N-2x6P-2	12.70	15.24	A2541H-N-2x26P-2	63.50	66.04
A2541H-N-2x7P-2	15.24	17.78	A2541H-N-2x27P-2	66.04	68.58
A2541H-N-2x8P-2	17.78	20.32	A2541H-N-2x28P-2	68.58	71.12
A2541H-N-2x9P-2	20.32	22.86	A2541H-N-2x29P-2	71.12	73.66
A2541H-N-2x10P-2	22.86	25.40	A2541H-N-2x30P-2	73.66	76.20
A2541H-N-2x11P-2	25.40	27.94	A2541H-N-2x31P-2	76.20	78.74
A2541H-N-2x12P-2	27.94	30.48	A2541H-N-2x32P-2	78.74	81.28
A2541H-N-2x13P-2	30.48	33.02	A2541H-N-2x33P-2	81.28	83.82
A2541H-N-2x14P-2	33.02	35.56	A2541H-N-2x34P-2	83.82	86.36
A2541H-N-2x15P-2	35.56	38.10	A2541H-N-2x35P-2	86.36	88.90
A2541H-N-2x16P-2	38.10	40.64	A2541H-N-2x36P-2	88.90	91.44
A2541H-N-2x17P-2	40.64	43.18	A2541H-N-2x37P-2	91.44	93.98
A2541H-N-2x18P-2	43.18	45.72	A2541H-N-2x38P-2	93.98	96.52
A2541H-N-2x19P-2	45.72	48.26	A2541H-N-2x39P-2	96.52	99.06
A2541H-N-2x20P-2	48.26	50.80	A2541H-N-2x40P-2	99.06	101.60
A2541H-N-2x21P-2	50.80	53.34			

Unit: mm

### A2541WV-2

2.54mm Pitch 180° Dual Row Pin Header

#### Reference Informations:

- \*Material: Pin: Brass/Gold over Nickel  
Insulator: PBT30%GF, UL94V-0
- \*Mates with CJT A2541 series dual row Housing  
Optional Gold plating available but MOQ requested
- \*Color: Black

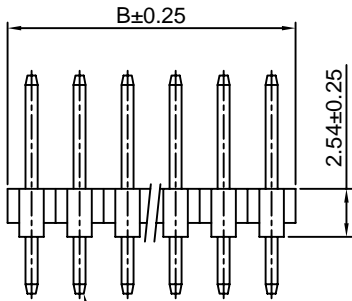
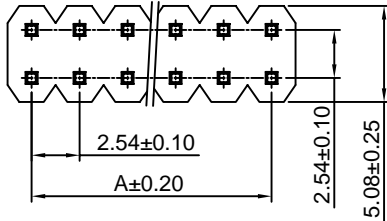

PIN 0.64 SQ

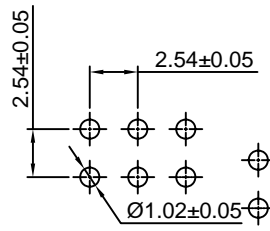

P.C.B LAYOUT

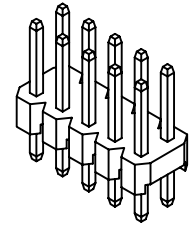

#### Ordering Information & Dimensions:

PART NO.	Dimensions		PART NO.	Dimensions	
	A	B		A	B
A2541WV-2x2P	2.54	5.08	A2541WV-2x22P	53.34	55.88
A2541WV-2x3P	5.08	7.62	A2541WV-2x23P	55.88	58.42
A2541WV-2x4P	7.62	10.16	A2541WV-2x24P	58.42	60.96
A2541WV-2x5P	10.16	12.70	A2541WV-2x25P	60.96	63.50
A2541WV-2x6P	12.70	15.24	A2541WV-2x26P	63.50	66.04
A2541WV-2x7P	15.24	17.78	A2541WV-2x27P	66.04	68.58
A2541WV-2x8P	17.78	20.32	A2541WV-2x28P	68.58	71.12
A2541WV-2x9P	20.32	22.86	A2541WV-2x29P	71.12	73.66
A2541WV-2x10P	22.86	25.40	A2541WV-2x30P	73.66	76.20
A2541WV-2x11P	25.40	27.94	A2541WV-2x31P	76.20	78.74
A2541WV-2x12P	27.94	30.48	A2541WV-2x32P	78.74	81.28
A2541WV-2x13P	30.48	33.02	A2541WV-2x33P	81.28	83.82
A2541WV-2x14P	33.02	35.56	A2541WV-2x34P	83.82	86.36
A2541WV-2x15P	35.56	38.10	A2541WV-2x35P	86.36	88.90
A2541WV-2x16P	38.10	40.64	A2541WV-2x36P	88.90	91.44
A2541WV-2x17P	40.64	43.18	A2541WV-2x37P	91.44	93.98
A2541WV-2x18P	43.18	45.72	A2541WV-2x38P	93.98	96.52
A2541WV-2x19P	45.72	48.26	A2541WV-2x39P	96.52	99.06
A2541WV-2x20P	48.26	50.80	A2541WV-2x40P	99.06	101.60
A2541WV-2x21P	50.80	53.34			

Unit: mm

### A2541WV-S-2

2.54mm Pitch 180° Dual Row Pin Header-SMT TYPE

#### Reference Informations:

- \*Material: Pin: Brass/Gold over Nickel  
Insulator: Nylon 6T, UL94V-0
- \*Mates with CJT A2541 series dual row Housing  
Optional Gold plating available but MOQ requested
- \*Color: Black

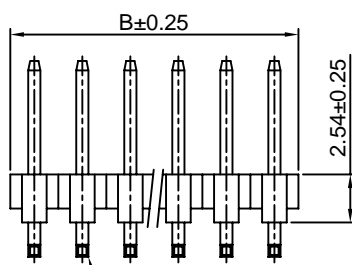
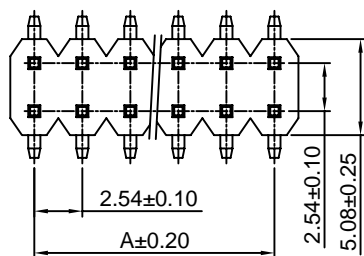

PIN 0.64 SQ

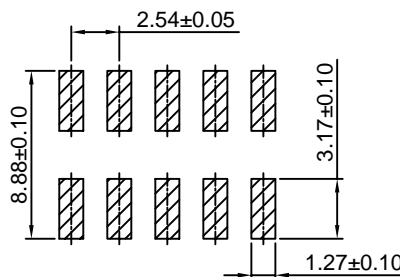

P.C.B LAYOUT

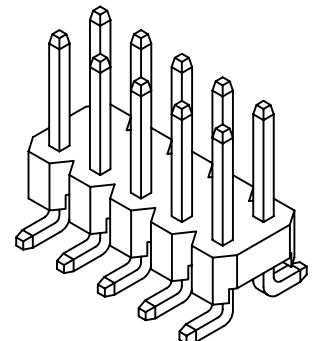

#### Ordering Information & Dimensions:

PART NO.	Dimensions		PART NO.	Dimensions	
	A	B		A	B
A2541WV-S-2x2P	2.54	5.08	A2541WV-S-2x22P	53.34	55.88
A2541WV-S-2x3P	5.08	7.62	A2541WV-S-2x23P	55.88	58.42
A2541WV-S-2x4P	7.62	10.16	A2541WV-S-2x24P	58.42	60.96
A2541WV-S-2x5P	10.16	12.70	A2541WV-S-2x25P	60.96	63.50
A2541WV-S-2x6P	12.70	15.24	A2541WV-S-2x26P	63.50	66.04
A2541WV-S-2x7P	15.24	17.78	A2541WV-S-2x27P	66.04	68.58
A2541WV-S-2x8P	17.78	20.32	A2541WV-S-2x28P	68.58	71.12
A2541WV-S-2x9P	20.32	22.86	A2541WV-S-2x29P	71.12	73.66
A2541WV-S-2x10P	22.86	25.40	A2541WV-S-2x30P	73.66	76.20
A2541WV-S-2x11P	25.40	27.94	A2541WV-S-2x31P	76.20	78.74
A2541WV-S-2x12P	27.94	30.48	A2541WV-S-2x32P	78.74	81.28
A2541WV-S-2x13P	30.48	33.02	A2541WV-S-2x33P	81.28	83.82
A2541WV-S-2x14P	33.02	35.56	A2541WV-S-2x34P	83.82	86.36
A2541WV-S-2x15P	35.56	38.10	A2541WV-S-2x35P	86.36	88.90
A2541WV-S-2x16P	38.10	40.64	A2541WV-S-2x36P	88.90	91.44
A2541WV-S-2x17P	40.64	43.18	A2541WV-S-2x37P	91.44	93.98
A2541WV-S-2x18P	43.18	45.72	A2541WV-S-2x38P	93.98	96.52
A2541WV-S-2x19P	45.72	48.26	A2541WV-S-2x39P	96.52	99.06
A2541WV-S-2x20P	48.26	50.80	A2541WV-S-2x40P	99.06	101.60
A2541WV-S-2x21P	50.80	53.34			

Unit: mm

### A2541WVA-2

2.54mm Pitch 180° Dual Row Pin Header

**Reference Informations:**

- \*Material: Pin: Brass/Gold over Nickel  
Insulator: PBT30%GF, UL94V-0
- \*Mates with CJT A2541 series dual row Housing  
Optional Gold plating available but MOQ requested
- \*Color: Black

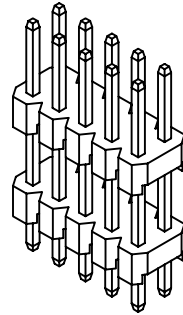
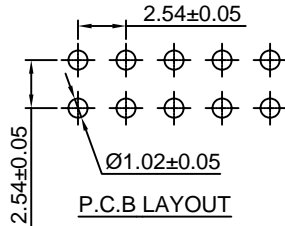
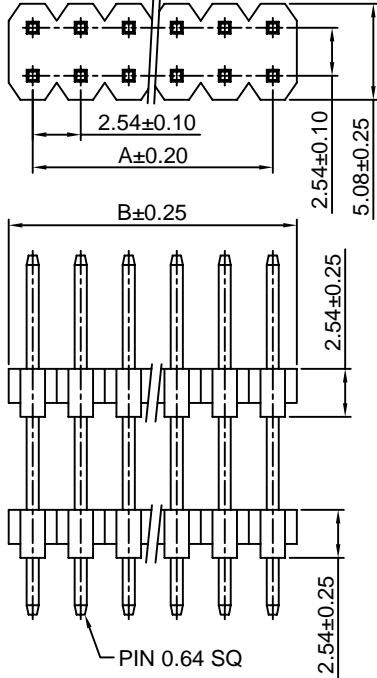

**Ordering Information & Dimensions:**

PART NO.	Dimensions		PART NO.	Dimensions	
	A	B		A	B
A2541WVA-2x2P	2.54	5.08	A2541WVA-2x22P	53.34	55.88
A2541WVA-2x3P	5.08	7.62	A2541WVA-2x23P	55.88	58.42
A2541WVA-2x4P	7.62	10.16	A2541WVA-2x24P	58.42	60.96
A2541WVA-2x5P	10.16	12.70	A2541WVA-2x25P	60.96	63.50
A2541WVA-2x6P	12.70	15.24	A2541WVA-2x26P	63.50	66.04
A2541WVA-2x7P	15.24	17.78	A2541WVA-2x27P	66.04	68.58
A2541WVA-2x8P	17.78	20.32	A2541WVA-2x28P	68.58	71.12
A2541WVA-2x9P	20.32	22.86	A2541WVA-2x29P	71.12	73.66
A2541WVA-2x10P	22.86	25.40	A2541WVA-2x30P	73.66	76.20
A2541WVA-2x11P	25.40	27.94	A2541WVA-2x31P	76.20	78.74
A2541WVA-2x12P	27.94	30.48	A2541WVA-2x32P	78.74	81.28
A2541WVA-2x13P	30.48	33.02	A2541WVA-2x33P	81.28	83.82
A2541WVA-2x14P	33.02	35.56	A2541WVA-2x34P	83.82	86.36
A2541WVA-2x15P	35.56	38.10	A2541WVA-2x35P	86.36	88.90
A2541WVA-2x16P	38.10	40.64	A2541WVA-2x36P	88.90	91.44
A2541WVA-2x17P	40.64	43.18	A2541WVA-2x37P	91.44	93.98
A2541WVA-2x18P	43.18	45.72	A2541WVA-2x38P	93.98	96.52
A2541WVA-2x19P	45.72	48.26	A2541WVA-2x39P	96.52	99.06
A2541WVA-2x20P	48.26	50.80	A2541WVA-2x40P	99.06	101.60
A2541WVA-2x21P	50.80	53.34			

Unit: mm

### A2541WVA-S-2

2.54mm Pitch 180° Dual Row Pin Header-SMT TYPE

**Reference Informations:**

- \*Material: Pin: Brass/Gold over Nickel  
Insulator: Nylon 6T, UL94V-0
- \*Mates with CJT A2541 series dual row Housing  
Optional Gold plating available but MOQ requested
- \*Color: Black

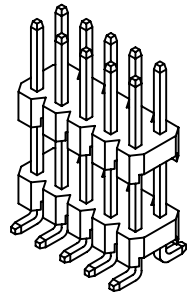
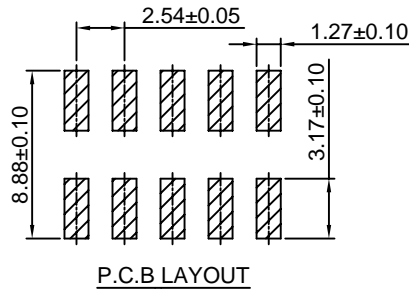
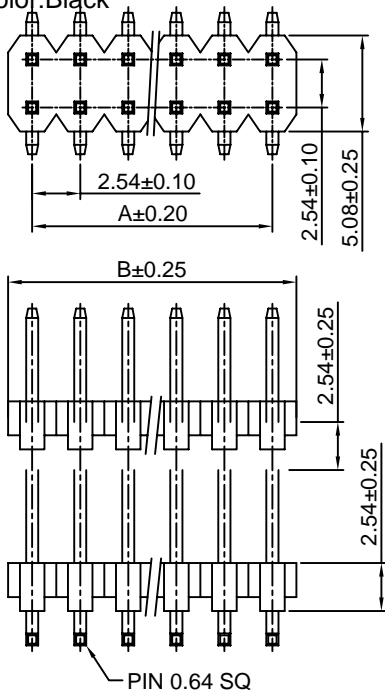

**Ordering Information & Dimensions:**

PART NO.	Dimensions		PART NO.	Dimensions	
	A	B		A	B
A2541WVA-S-2x2P	2.54	5.08	A2541WVA-S-2x22P	53.34	55.88
A2541WVA-S-2x3P	5.08	7.62	A2541WVA-S-2x23P	55.88	58.42
A2541WVA-S-2x4P	7.62	10.16	A2541WVA-S-2x24P	58.42	60.96
A2541WVA-S-2x5P	10.16	12.70	A2541WVA-S-2x25P	60.96	63.50
A2541WVA-S-2x6P	12.70	15.24	A2541WVA-S-2x26P	63.50	66.04
A2541WVA-S-2x7P	15.24	17.78	A2541WVA-S-2x27P	66.04	68.58
A2541WVA-S-2x8P	17.78	20.32	A2541WVA-S-2x28P	68.58	71.12
A2541WVA-S-2x9P	20.32	22.86	A2541WVA-S-2x29P	71.12	73.66
A2541WVA-S-2x10P	22.86	25.40	A2541WVA-S-2x30P	73.66	76.20
A2541WVA-S-2x11P	25.40	27.94	A2541WVA-S-2x31P	76.20	78.74
A2541WVA-S-2x12P	27.94	30.48	A2541WVA-S-2x32P	78.74	81.28
A2541WVA-S-2x13P	30.48	33.02	A2541WVA-S-2x33P	81.28	83.82
A2541WVA-S-2x14P	33.02	35.56	A2541WVA-S-2x34P	83.82	86.36
A2541WVA-S-2x15P	35.56	38.10	A2541WVA-S-2x35P	86.36	88.90
A2541WVA-S-2x16P	38.10	40.64	A2541WVA-S-2x36P	88.90	91.44
A2541WVA-S-2x17P	40.64	43.18	A2541WVA-S-2x37P	91.44	93.98
A2541WVA-S-2x18P	43.18	45.72	A2541WVA-S-2x38P	93.98	96.52
A2541WVA-S-2x19P	45.72	48.26	A2541WVA-S-2x39P	96.52	99.06
A2541WVA-S-2x20P	48.26	50.80	A2541WVA-S-2x40P	99.06	101.60
A2541WVA-S-2x21P	50.80	53.34			

Unit: mm

### A2541WR-2

2.54mm Pitch 90° Dual Row Pin Header

#### Reference Informations:

- \*Material: Pin: Brass/Gold over Nickel  
Insulator: PBT30%GF, UL94V-0
- \*Mates with CJT A2541 series dual row Housing  
Optional Gold plating available but MOQ requested
- \*Color: Black

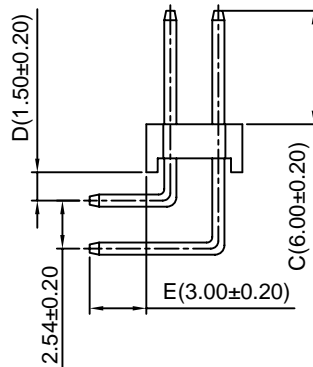
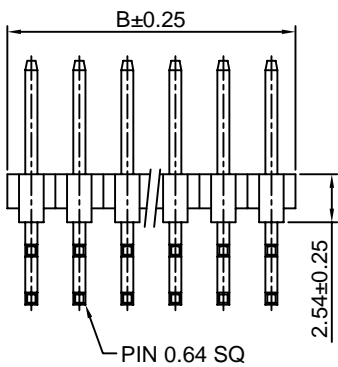
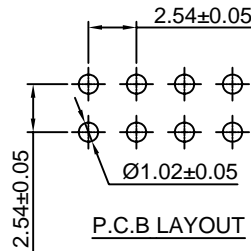
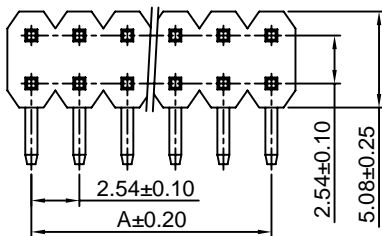
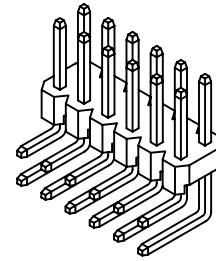

#### Ordering Information & Dimensions:

PART NO.	Dimensions		PART NO.	Dimensions	
	A	B		A	B
A2541WR-2x2P	2.54	5.08	A2541WR-2x22P	53.34	55.88
A2541WR-2x3P	5.08	7.62	A2541WR-2x23P	55.88	58.42
A2541WR-2x4P	7.62	10.16	A2541WR-2x24P	58.42	60.96
A2541WR-2x5P	10.16	12.70	A2541WR-2x25P	60.96	63.50
A2541WR-2x6P	12.70	15.24	A2541WR-2x26P	63.50	66.04
A2541WR-2x7P	15.24	17.78	A2541WR-2x27P	66.04	68.58
A2541WR-2x8P	17.78	20.32	A2541WR-2x28P	68.58	71.12
A2541WR-2x9P	20.32	22.86	A2541WR-2x29P	71.12	73.66
A2541WR-2x10P	22.86	25.40	A2541WR-2x30P	73.66	76.20
A2541WR-2x11P	25.40	27.94	A2541WR-2x31P	76.20	78.74
A2541WR-2x12P	27.94	30.48	A2541WR-2x32P	78.74	81.28
A2541WR-2x13P	30.48	33.02	A2541WR-2x33P	81.28	83.82
A2541WR-2x14P	33.02	35.56	A2541WR-2x34P	83.82	86.36
A2541WR-2x15P	35.56	38.10	A2541WR-2x35P	86.36	88.90
A2541WR-2x16P	38.10	40.64	A2541WR-2x36P	88.90	91.44
A2541WR-2x17P	40.64	43.18	A2541WR-2x37P	91.44	93.98
A2541WR-2x18P	43.18	45.72	A2541WR-2x38P	93.98	96.52
A2541WR-2x19P	45.72	48.26	A2541WR-2x39P	96.52	99.06
A2541WR-2x20P	48.26	50.80	A2541WR-2x40P	99.06	101.60
A2541WR-2x21P	50.80	53.34			

Unit: mm

### A2541WRA-2

2.54mm Pitch 90° Dual Row Pin Header

#### Reference Informations:

- \*Material: Pin: Brass/Gold over Nickel  
Insulator: PBT30%GF, UL94V-0
- \*Mates with CJT A2541 series dual row Housing  
Optional Gold plating available but MOQ requested
- \*Color: Black

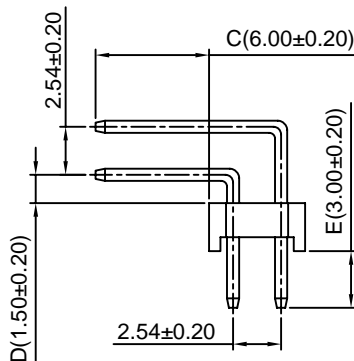
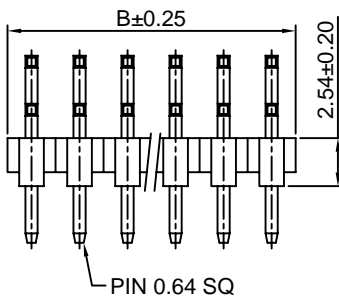
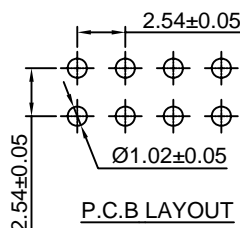
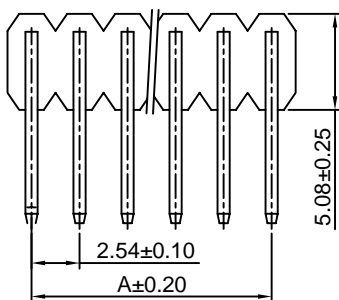
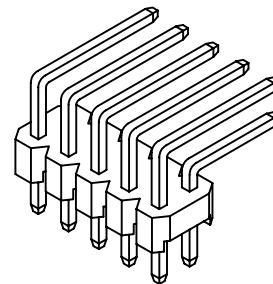

#### Ordering Information & Dimensions:

PART NO.	Dimensions		PART NO.	Dimensions	
	A	B		A	B
A2541WRA-2x2P	2.54	5.08	A2541WRA-2x22P	53.34	55.88
A2541WRA-2x3P	5.08	7.62	A2541WRA-2x23P	55.88	58.42
A2541WRA-2x4P	7.62	10.16	A2541WRA-2x24P	58.42	60.96
A2541WRA-2x5P	10.16	12.70	A2541WRA-2x25P	60.96	63.50
A2541WRA-2x6P	12.70	15.24	A2541WRA-2x26P	63.50	66.04
A2541WRA-2x7P	15.24	17.78	A2541WRA-2x27P	66.04	68.58
A2541WRA-2x8P	17.78	20.32	A2541WRA-2x28P	68.58	71.12
A2541WRA-2x9P	20.32	22.86	A2541WRA-2x29P	71.12	73.66
A2541WRA-2x10P	22.86	25.40	A2541WRA-2x30P	73.66	76.20
A2541WRA-2x11P	25.40	27.94	A2541WRA-2x31P	76.20	78.74
A2541WRA-2x12P	27.94	30.48	A2541WRA-2x32P	78.74	81.28
A2541WRA-2x13P	30.48	33.02	A2541WRA-2x33P	81.28	83.82
A2541WRA-2x14P	33.02	35.56	A2541WRA-2x34P	83.82	86.36
A2541WRA-2x15P	35.56	38.10	A2541WRA-2x35P	86.36	88.90
A2541WRA-2x16P	38.10	40.64	A2541WRA-2x36P	88.90	91.44
A2541WRA-2x17P	40.64	43.18	A2541WRA-2x37P	91.44	93.98
A2541WRA-2x18P	43.18	45.72	A2541WRA-2x38P	93.98	96.52
A2541WRA-2x19P	45.72	48.26	A2541WRA-2x39P	96.52	99.06
A2541WRA-2x20P	48.26	50.80	A2541WRA-2x40P	99.06	101.60
A2541WRA-2x21P	50.80	53.34			

Unit: mm



### A2541WV-N-2

2.54mm Pitch 180° Dual Row Box Header

**Reference Informations:**

- \*Material:Pin:Brass/Gold over Nickel  
Insulator:PBT15%GF,UL94V-0
- \*Mates with CJT A2541H-N series Dual row Housing
- \*Color:Black

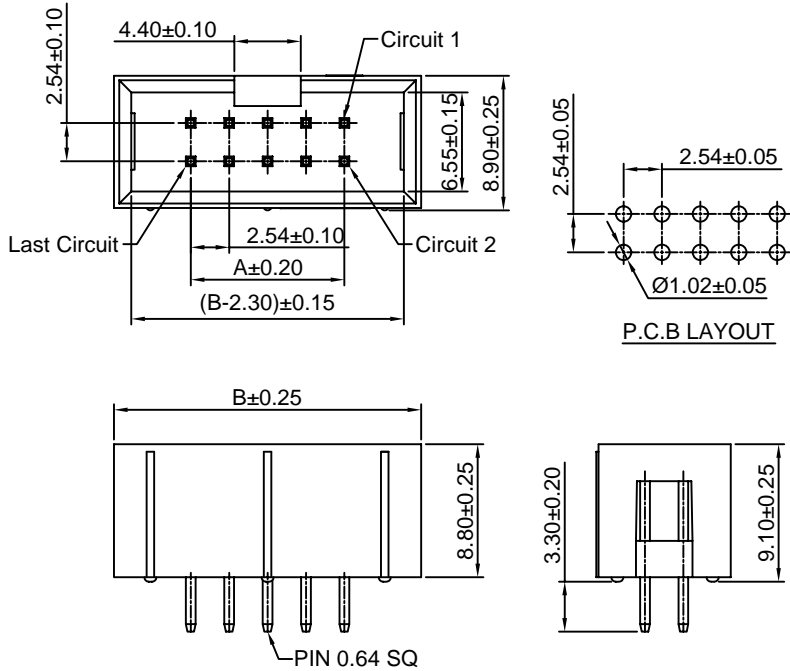
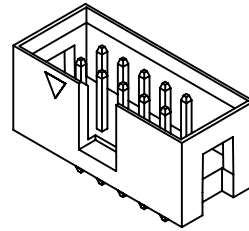

**Ordering Information & Dimensions:**

PART NO.	Dimensions		PART NO.	Dimensions	
	A	B		A	B
A2541WV-N-2x2P	2.54	12.70	A2541WV-N-2x22P	53.34	63.50
A2541WV-N-2x3P	5.08	15.24	A2541WV-N-2x23P	55.88	66.04
A2541WV-N-2x4P	7.62	17.78	A2541WV-N-2x24P	58.42	68.58
A2541WV-N-2x5P	10.16	20.32	A2541WV-N-2x25P	60.96	71.12
A2541WV-N-2x6P	12.70	22.86	A2541WV-N-2x26P	63.50	73.66
A2541WV-N-2x7P	15.24	25.40	A2541WV-N-2x27P	66.04	76.20
A2541WV-N-2x8P	17.78	27.94	A2541WV-N-2x28P	68.58	78.74
A2541WV-N-2x9P	20.32	30.48	A2541WV-N-2x29P	71.12	81.28
A2541WV-N-2x10P	22.86	33.02	A2541WV-N-2x30P	73.66	83.82
A2541WV-N-2x11P	25.40	35.56	A2541WV-N-2x31P	76.20	86.36
A2541WV-N-2x12P	27.94	38.10	A2541WV-N-2x32P	78.74	88.90
A2541WV-N-2x13P	30.48	40.64	A2541WV-N-2x33P	81.28	91.44
A2541WV-N-2x14P	33.02	43.18	A2541WV-N-2x34P	83.82	93.98
A2541WV-N-2x15P	35.56	45.72	A2541WV-N-2x35P	86.36	96.52
A2541WV-N-2x16P	38.10	48.26	A2541WV-N-2x36P	88.90	99.06
A2541WV-N-2x17P	40.64	50.80	A2541WV-N-2x37P	91.44	101.60
A2541WV-N-2x18P	43.18	53.34	A2541WV-N-2x38P	93.98	104.14
A2541WV-N-2x19P	45.72	55.88	A2541WV-N-2x39P	96.52	106.68
A2541WV-N-2x20P	48.26	58.42	A2541WV-N-2x40P	99.06	109.22
A2541WV-N-2x21P	50.80	60.96			

Unit: mm

### A2541WR-N-2

2.54mm Pitch 90° Dual Row Box Header

**Reference Informations:**

- \*Material:Pin:Brass/Gold over Nickel  
Insulator:PBT15%GF,UL94V-0
- \*Mates with CJT A2541H-N series Dual row Housing
- \*Color:Black

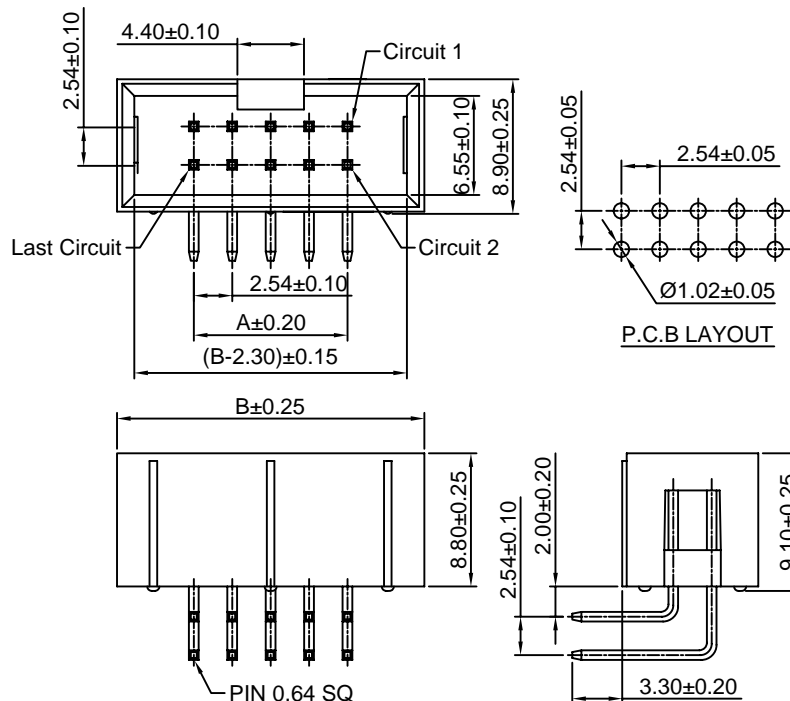
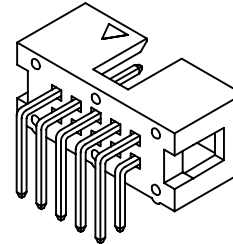

**Ordering Information & Dimensions:**

PART NO.	Dimensions		PART NO.	Dimensions	
	A	B		A	B
A2541WR-N-2x2P	2.54	12.70	A2541WR-N-2x22P	53.34	63.50
A2541WR-N-2x3P	5.08	15.24	A2541WR-N-2x23P	55.88	66.04
A2541WR-N-2x4P	7.62	17.78	A2541WR-N-2x24P	58.42	68.58
A2541WR-N-2x5P	10.16	20.32	A2541WR-N-2x25P	60.96	71.12
A2541WR-N-2x6P	12.70	22.86	A2541WR-N-2x26P	63.50	73.66
A2541WR-N-2x7P	15.24	25.40	A2541WR-N-2x27P	66.04	76.20
A2541WR-N-2x8P	17.78	27.94	A2541WR-N-2x28P	68.58	78.74
A2541WR-N-2x9P	20.32	30.48	A2541WR-N-2x29P	71.12	81.28
A2541WR-N-2x10P	22.86	33.02	A2541WR-N-2x30P	73.66	83.82
A2541WR-N-2x11P	25.40	35.56	A2541WR-N-2x31P	76.20	86.36
A2541WR-N-2x12P	27.94	38.10	A2541WR-N-2x32P	78.74	88.90
A2541WR-N-2x13P	30.48	40.64	A2541WR-N-2x33P	81.28	91.44
A2541WR-N-2x14P	33.02	43.18	A2541WR-N-2x34P	83.82	93.98
A2541WR-N-2x15P	35.56	45.72	A2541WR-N-2x35P	86.36	96.52
A2541WR-N-2x16P	38.10	48.26	A2541WR-N-2x36P	88.90	99.06
A2541WR-N-2x17P	40.64	50.80	A2541WR-N-2x37P	91.44	101.60
A2541WR-N-2x18P	43.18	53.34	A2541WR-N-2x38P	93.98	104.14
A2541WR-N-2x19P	45.72	55.88	A2541WR-N-2x39P	96.52	106.68
A2541WR-N-2x20P	48.26	58.42	A2541WR-N-2x40P	99.06	109.22
A2541WR-N-2x21P	50.80	60.96			

Unit: mm



### A2541HVV

2.54mm Pitch 180° Single Row Box Header

**Reference Informations:**

- \*Material:Pin:Brass/Gold over Nickel  
Insulator:PBT15%GF,UL94V-0
- \*Mates with CJT A2541 series Single row Pin Header
- \*Color:Black

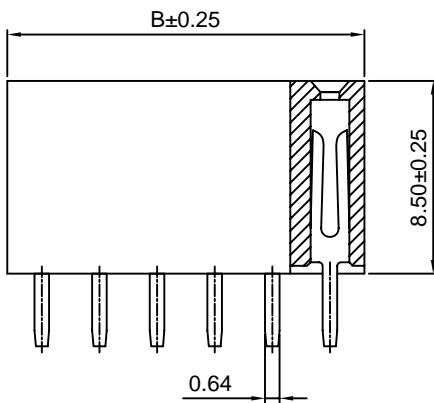
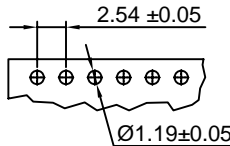
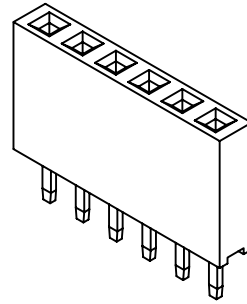

**P.C.B LAYOUT**

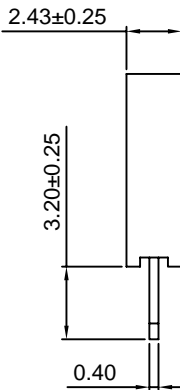

**Ordering Information & Dimensions:**

PART NO.	Dimensions		PART NO.	Dimensions	
	A	B		A	B
A2541HVV-2P	2.54	5.58	A2541HVV-22P	53.34	56.38
A2541HVV-3P	5.08	8.12	A2541HVV-23P	55.88	58.92
A2541HVV-4P	7.62	10.66	A2541HVV-24P	58.42	61.46
A2541HVV-5P	10.16	13.20	A2541HVV-25P	60.96	64.00
A2541HVV-6P	12.70	15.74	A2541HVV-26P	63.50	66.54
A2541HVV-7P	15.24	18.28	A2541HVV-27P	66.04	69.08
A2541HVV-8P	17.78	20.82	A2541HVV-28P	68.58	71.62
A2541HVV-9P	20.32	23.36	A2541HVV-29P	71.12	74.16
A2541HVV-10P	22.86	25.90	A2541HVV-30P	73.66	76.70
A2541HVV-11P	25.40	28.44	A2541HVV-31P	76.20	79.24
A2541HVV-12P	27.94	30.98	A2541HVV-32P	78.74	81.78
A2541HVV-13P	30.48	33.52	A2541HVV-33P	81.28	84.32
A2541HVV-14P	33.02	36.06	A2541HVV-34P	83.82	86.86
A2541HVV-15P	35.56	38.60	A2541HVV-35P	86.36	89.40
A2541HVV-16P	38.10	41.14	A2541HVV-36P	88.90	91.94
A2541HVV-17P	40.64	43.68	A2541HVV-37P	91.44	94.48
A2541HVV-18P	43.18	46.22	A2541HVV-38P	93.98	97.02
A2541HVV-19P	45.72	48.76	A2541HVV-39P	96.52	99.56
A2541HVV-20P	48.26	51.30	A2541HVV-40P	99.06	102.20
A2541HVV-21P	50.80	53.84			

Unit: mm

### A2541HWR

2.54mm Pitch 90° Single Row Box Header

**Reference Informations:**

- \*Material:Pin:Brass/Gold over Nickel  
Insulator:PBT15%GF,UL94V-0
- \*Mates with CJT A2541 series Single row Pin Header
- \*Color:Black

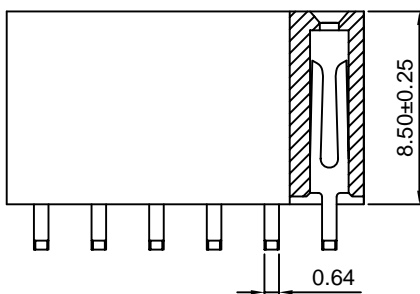
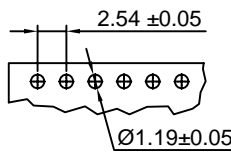
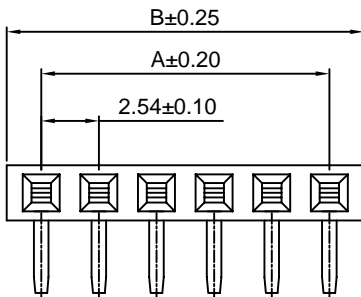
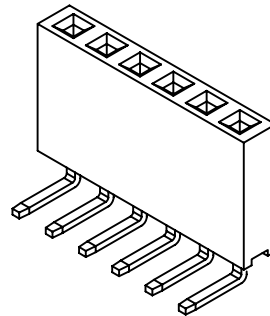

**P.C.B LAYOUT**

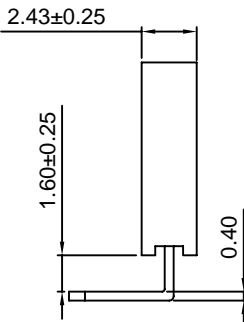

**Ordering Information & Dimensions:**

PART NO.	Dimensions		PART NO.	Dimensions	
	A	B		A	B
A2541HWR-2P	2.54	5.58	A2541HWR-22P	53.34	56.38
A2541HWR-3P	5.08	8.12	A2541HWR-23P	55.88	58.92
A2541HWR-4P	7.62	10.66	A2541HWR-24P	58.42	61.46
A2541HWR-5P	10.16	13.20	A2541HWR-25P	60.96	64.00
A2541HWR-6P	12.70	15.74	A2541HWR-26P	63.50	66.54
A2541HWR-7P	15.24	18.28	A2541HWR-27P	66.04	69.08
A2541HWR-8P	17.78	20.82	A2541HWR-28P	68.58	71.62
A2541HWR-9P	20.32	23.36	A2541HWR-29P	71.12	74.16
A2541HWR-10P	22.86	25.90	A2541HWR-30P	73.66	76.70
A2541HWR-11P	25.40	28.44	A2541HWR-31P	76.20	79.24
A2541HWR-12P	27.94	30.98	A2541HWR-32P	78.74	81.78
A2541HWR-13P	30.48	33.52	A2541HWR-33P	81.28	84.32
A2541HWR-14P	33.02	36.06	A2541HWR-34P	83.82	86.86
A2541HWR-15P	35.56	38.60	A2541HWR-35P	86.36	89.40
A2541HWR-16P	38.10	41.14	A2541HWR-36P	88.90	91.94
A2541HWR-17P	40.64	43.68	A2541HWR-37P	91.44	94.48
A2541HWR-18P	43.18	46.22	A2541HWR-38P	93.98	97.02
A2541HWR-19P	45.72	48.76	A2541HWR-39P	96.52	99.56
A2541HWR-20P	48.26	51.30	A2541HWR-40P	99.06	102.20
A2541HWR-21P	50.80	53.84			

Unit: mm

### A2541HWV-2

2.54mm Pitch 180° Dual Row Box Header

**Reference Informations:**

- \*Material: Pin: Brass/Gold over Nickel  
Insulator: PBT15%GF, UL94V-0
- \*Mates with CJT A2541 series Dual row Pin Header
- \*Color: Black

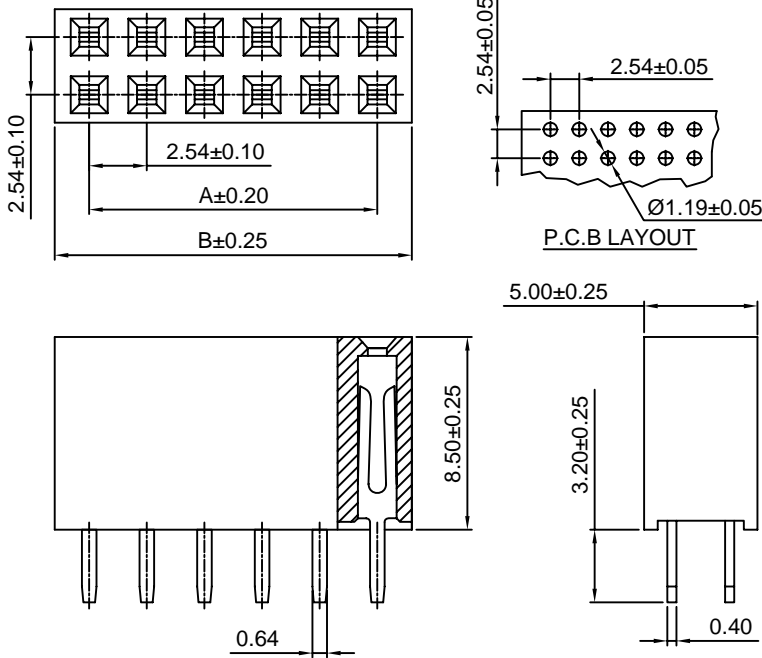
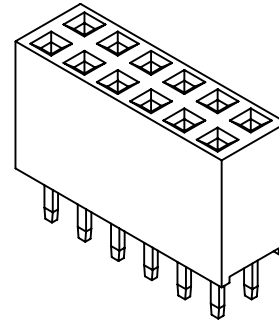

**Ordering Information & Dimensions:**

PART NO.	Dimensions		PART NO.	Dimensions	
	A	B		A	B
A2541HWV-2x2P	2.54	5.58	A2541HWV-2x22P	53.34	56.38
A2541HWV-2x3P	5.08	8.12	A2541HWV-2x23P	55.88	58.92
A2541HWV-2x4P	7.62	10.66	A2541HWV-2x24P	58.42	61.46
A2541HWV-2x5P	10.16	13.20	A2541HWV-2x25P	60.96	64.00
A2541HWV-2x6P	12.70	15.74	A2541HWV-2x26P	63.50	66.54
A2541HWV-2x7P	15.24	18.28	A2541HWV-2x27P	66.04	69.08
A2541HWV-2x8P	17.78	20.82	A2541HWV-2x28P	68.58	71.62
A2541HWV-2x9P	20.32	23.36	A2541HWV-2x29P	71.12	74.16
A2541HWV-2x10P	22.86	25.90	A2541HWV-2x30P	73.66	76.70
A2541HWV-2x11P	25.40	28.44	A2541HWV-2x31P	76.20	79.24
A2541HWV-2x12P	27.94	30.98	A2541HWV-2x32P	78.74	81.78
A2541HWV-2x13P	30.48	33.52	A2541HWV-2x33P	81.28	84.32
A2541HWV-2x14P	33.02	36.06	A2541HWV-2x34P	83.82	86.86
A2541HWV-2x15P	35.56	38.60	A2541HWV-2x35P	86.36	89.40
A2541HWV-2x16P	38.10	41.14	A2541HWV-2x36P	88.90	91.94
A2541HWV-2x17P	40.64	43.68	A2541HWV-2x37P	91.44	94.48
A2541HWV-2x18P	43.18	46.22	A2541HWV-2x38P	93.98	97.02
A2541HWV-2x19P	45.72	48.76	A2541HWV-2x39P	96.52	99.56
A2541HWV-2x20P	48.26	51.30	A2541HWV-2x40P	99.06	102.20
A2541HWV-2x21P	50.80	53.84			

Unit: mm

### A2541HWR-2

2.54mm Pitch 90° Dual Row Box Header

**Reference Informations:**

- \*Material: Pin: Brass/Gold over Nickel  
Insulator: PBT15%GF, UL94V-0
- \*Mates with CJT A2541 series Dual row Pin Header
- \*Color: Black

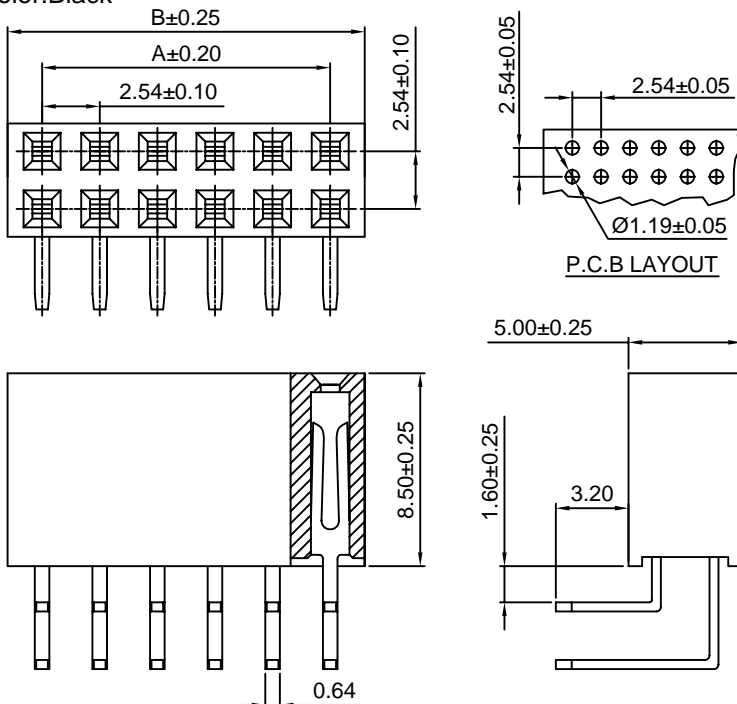
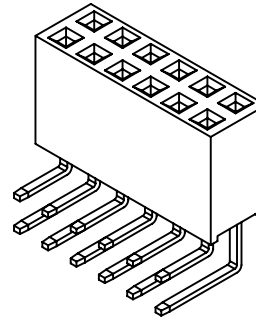

**Ordering Information & Dimensions:**

PART NO.	Dimensions		PART NO.	Dimensions	
	A	B		A	B
A2541HWR-2x2P	2.54	5.58	A2541HWR-2x22P	53.34	56.38
A2541HWR-2x3P	5.08	8.12	A2541HWR-2x23P	55.88	58.92
A2541HWR-2x4P	7.62	10.66	A2541HWR-2x24P	58.42	61.46
A2541HWR-2x5P	10.16	13.20	A2541HWR-2x25P	60.96	64.00
A2541HWR-2x6P	12.70	15.74	A2541HWR-2x26P	63.50	66.54
A2541HWR-2x7P	15.24	18.28	A2541HWR-2x27P	66.04	69.08
A2541HWR-2x8P	17.78	20.82	A2541HWR-2x28P	68.58	71.62
A2541HWR-2x9P	20.32	23.36	A2541HWR-2x29P	71.12	74.16
A2541HWR-2x10P	22.86	25.90	A2541HWR-2x30P	73.66	76.70
A2541HWR-2x11P	25.40	28.44	A2541HWR-2x31P	76.20	79.24
A2541HWR-2x12P	27.94	30.98	A2541HWR-2x32P	78.74	81.78
A2541HWR-2x13P	30.48	33.52	A2541HWR-2x33P	81.28	84.32
A2541HWR-2x14P	33.02	36.06	A2541HWR-2x34P	83.82	86.86
A2541HWR-2x15P	35.56	38.60	A2541HWR-2x35P	86.36	89.40
A2541HWR-2x16P	38.10	41.14	A2541HWR-2x36P	88.90	91.94
A2541HWR-2x17P	40.64	43.68	A2541HWR-2x37P	91.44	94.48
A2541HWR-2x18P	43.18	46.22	A2541HWR-2x38P	93.98	97.02
A2541HWR-2x19P	45.72	48.76	A2541HWR-2x39P	96.52	99.56
A2541HWR-2x20P	48.26	51.30	A2541HWR-2x40P	99.06	102.20
A2541HWR-2x21P	50.80	53.84			

Unit: mm

## X-ON Electronics

Largest Supplier of Electrical and Electronic Components

*Click to view similar products for [Headers & Wire Housings](#) category:*

*Click to view products by [Changjiang](#) manufacturer:*

Other Similar products are found below :

[57102-F02-18ULF](#) [58102-G61-06LF](#) [0009485154](#) [009176003701906](#) [0050291907](#) [02.125.8002.8](#) [609-3404](#) [61062-3](#) [622-0430](#) [622-3653LF](#)  
[63453-116](#) [636-1030](#) [636-1427](#) [636-3427](#) [636-4007](#) [641938-9](#) [644827-2](#) [65495-038](#) [65692-001LF](#) [65781-018](#) [65781-047](#) [65817-010LF](#)  
[65817-015LF](#) [66207-023LF](#) [67016-026LF](#) [67095-007LF](#) [68631-112](#) [68645-018](#) [68648-049](#) [699319-000](#) [70.362.1628.0](#) [70-4210](#) [70-4226B](#)  
[70-4853B](#) [707-5020](#) [707-5028](#) [71.350.2428.0](#) [71961-016LF](#) [733-134](#) [754199-000](#) [760-3052](#) [787-8014-00](#) [FCN-367T-T012/H](#) [80.063.4001.1](#)  
[800-90-001-10-001000](#) [800-90-010-10-002000](#) [801-43-002-10-013000](#) [801-43-006-10-002000](#) [803-41-018-10-001000](#) [803-43-014-20-](#)  
[001000](#)