

Specifications

Current rating:3A AC,DC

Voltage rating:250V AC,DC

Temperature range:-40°C~+105°C

Contact resistance:20mΩ Max.

Insulation resistance:1000MΩ Min.

Withstanding voltage:1500V AC/minute

Compliant with RoHS and REACH

Meet the HF/Halogen Free,need to customize

Contact CJT for details

Standards



E326732



E326732

Assembly layout

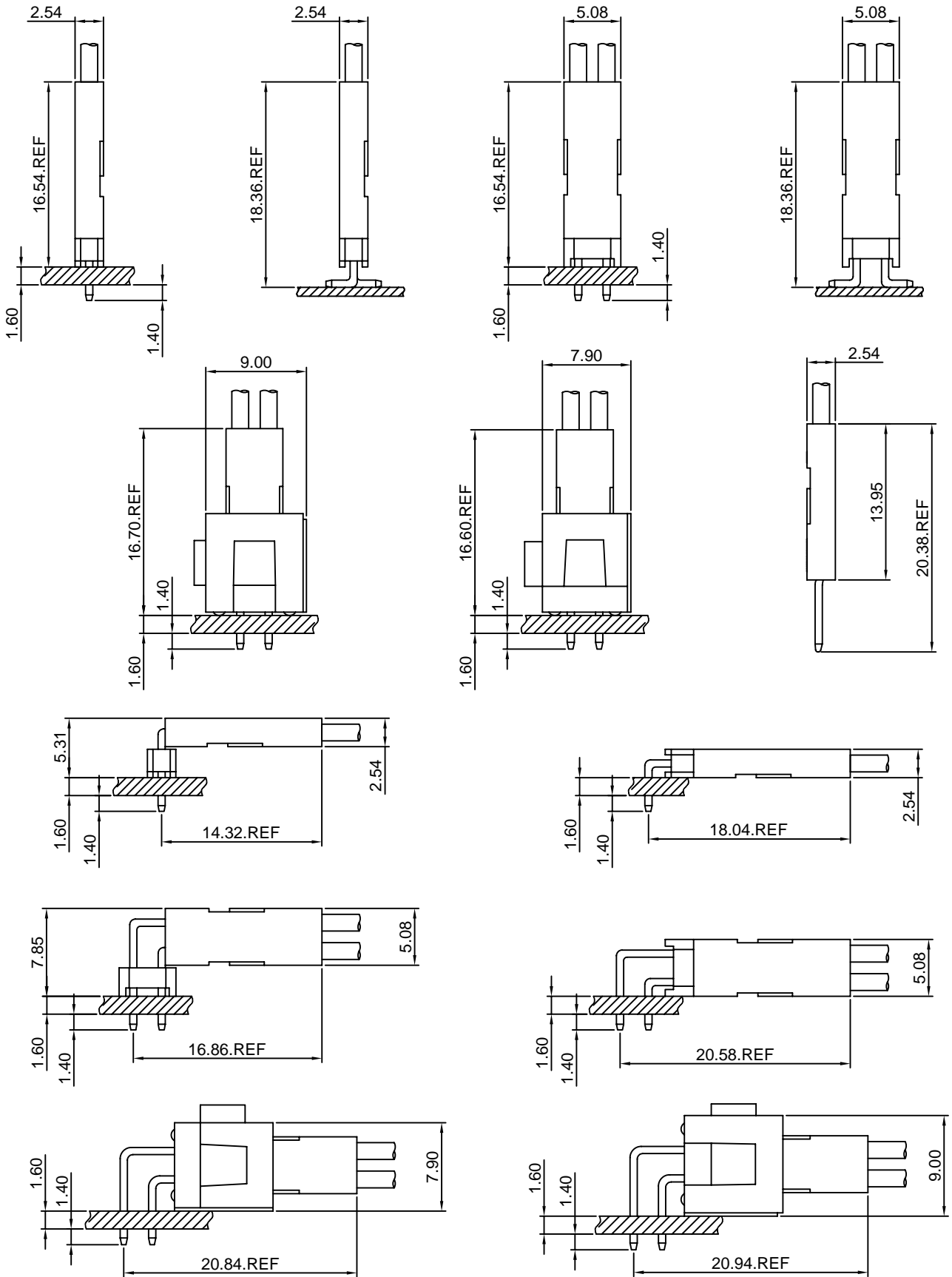

A2541-T

2.54mm Pitch Crimp Terminal

Reference Informations:

*Used in CJT A2541 series Housing

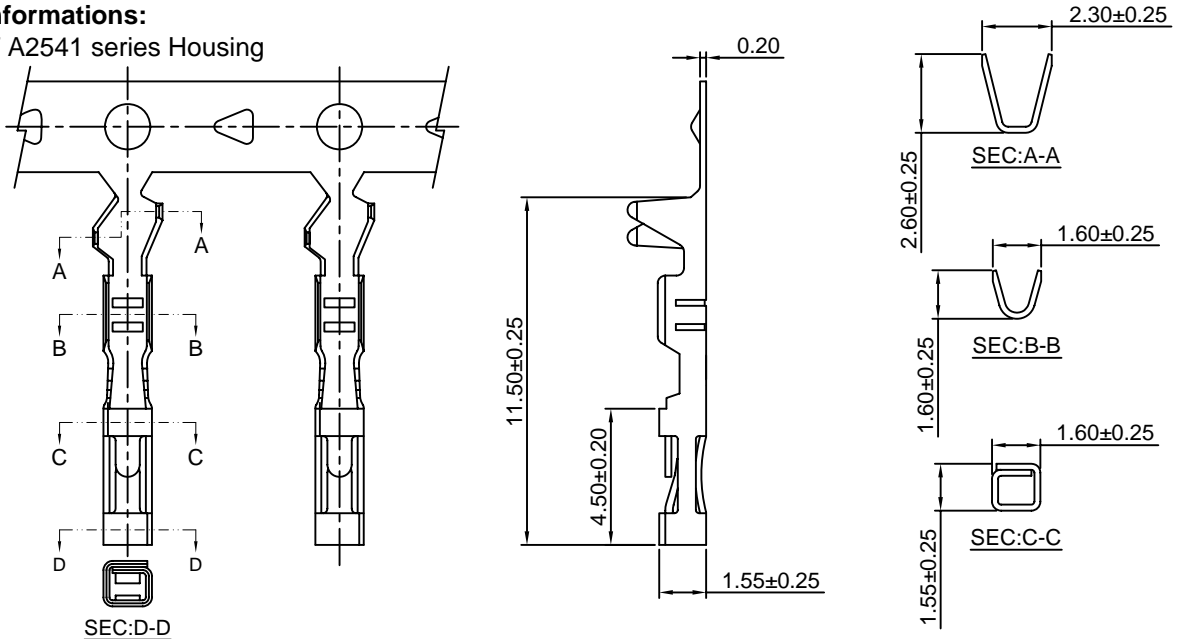

Ordering information & Specifications:

Unit:mm

| Part NO. | Wire Range | Insulation O.D. | Material | Finish | Qty/reel |
|----------|------------|-----------------|-----------------|------------------|------------|
| A2541-TB | AWG#22-#26 | 1.63mm(max) | Brass | Tin over Nickel | 10,000 PCS |
| A2541-TP | AWG#22-#26 | 1.63mm(max) | Phosphor Bronze | Tin over Nickel | 10,000 PCS |
| A2541-GB | AWG#22-#26 | 1.63mm(max) | Brass | Gold over Nickel | 10,000 PCS |
| A2541-GP | AWG#22-#26 | 1.63mm(max) | Phosphor Bronze | Gold over Nickel | 10,000 PCS |

Optional Gold plating available but MOQ requested

A2541M-T

2.54mm Pitch Crimp Terminal

Reference Informations:

*Used in CJT A2541 series Housing

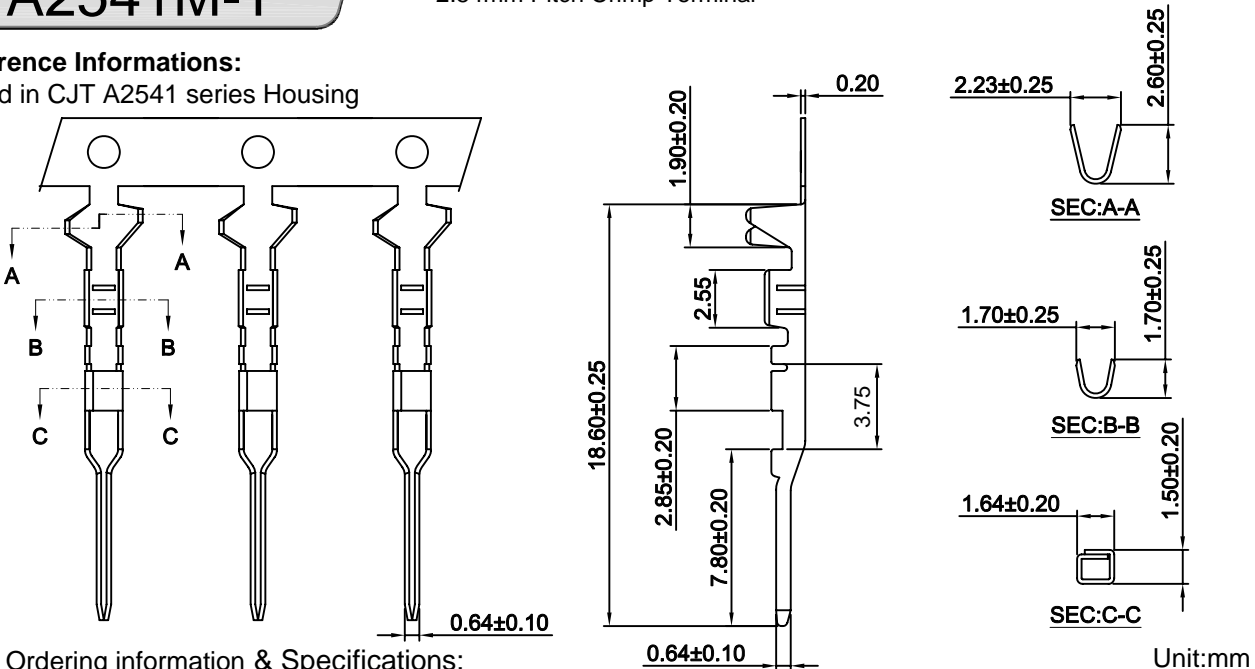

Ordering information & Specifications:

Unit:mm

| Part NO | Wire Range | Insulation O.D. | Material | Finish | Qty/reel |
|-----------|------------|-----------------|-----------------|------------------|------------|
| A2541M-TB | AWG#22-#26 | 1.63mm(max) | Brass | Tin over Nickel | 10,000 PCS |
| A2541M-TP | AWG#22-#26 | 1.63mm(max) | Phosphor Bronze | Tin over Nickel | 10,000 PCS |
| A2541M-GB | AWG#22-#26 | 1.63mm(max) | Brass | Gold over Nickel | 10,000 PCS |
| A2541M-GP | AWG#22-#26 | 1.63mm(max) | Phosphor Bronze | Gold over Nickel | 10,000 PCS |

Optional Gold plating available but MOQ requested

A2541H

2.54mm Pitch Single Row Housing

Reference Informations:

- *Material:PBT,UL94V-0
- *Suitable CJT A2541 series Terminal or A2541M series Terminal
- *Mates with CJT A2541 series Single row Pin Header
- *Color:Black

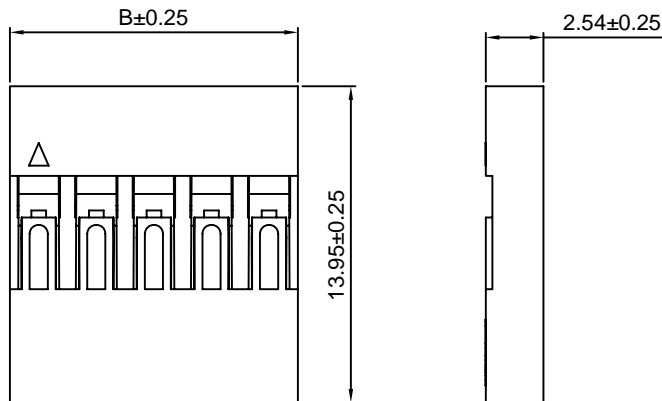
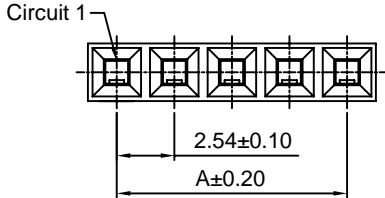
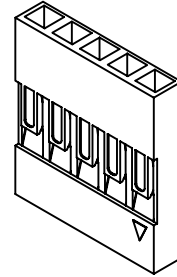

Ordering Information & Dimensions:

| PART NO. | Dimensions | | PART NO. | Dimensions | |
|------------|------------|-------|------------|------------|--------|
| | A | B | | A | B |
| A2541H-1P | ----- | 2.54 | A2541H-21P | 50.80 | 53.34 |
| A2541H-2P | 2.54 | 5.08 | A2541H-22P | 53.34 | 55.88 |
| A2541H-3P | 5.08 | 7.62 | A2541H-23P | 55.88 | 58.42 |
| A2541H-4P | 7.62 | 10.16 | A2541H-24P | 58.42 | 60.96 |
| A2541H-5P | 10.16 | 12.70 | A2541H-25P | 60.96 | 63.50 |
| A2541H-6P | 12.70 | 15.24 | A2541H-26P | 63.50 | 66.04 |
| A2541H-7P | 15.24 | 17.78 | A2541H-27P | 66.04 | 68.58 |
| A2541H-8P | 17.78 | 20.32 | A2541H-28P | 68.58 | 71.12 |
| A2541H-9P | 20.32 | 22.86 | A2541H-29P | 71.12 | 73.66 |
| A2541H-10P | 22.86 | 25.40 | A2541H-30P | 73.66 | 76.20 |
| A2541H-11P | 25.40 | 27.94 | A2541H-31P | 76.20 | 78.74 |
| A2541H-12P | 27.94 | 30.48 | A2541H-32P | 78.74 | 81.28 |
| A2541H-13P | 30.48 | 33.02 | A2541H-33P | 81.28 | 83.82 |
| A2541H-14P | 33.02 | 35.56 | A2541H-34P | 83.82 | 86.36 |
| A2541H-15P | 35.56 | 38.10 | A2541H-35P | 86.36 | 88.90 |
| A2541H-16P | 38.10 | 40.64 | A2541H-36P | 88.90 | 91.44 |
| A2541H-17P | 40.64 | 43.18 | A2541H-37P | 91.44 | 93.98 |
| A2541H-18P | 43.18 | 45.72 | A2541H-38P | 93.98 | 96.52 |
| A2541H-19P | 45.72 | 48.26 | A2541H-39P | 96.52 | 99.06 |
| A2541H-20P | 48.26 | 50.80 | A2541H-40P | 99.06 | 101.60 |

Unit: mm

A2541H-N

2.54mm Pitch Single Row Housing

Reference Informations:

- *Material:PBT,UL94V-0
- *Suitable CJT A2541 series Terminal
- *Mates with CJT A2541 series Single row Pin Header
- *Color:Black

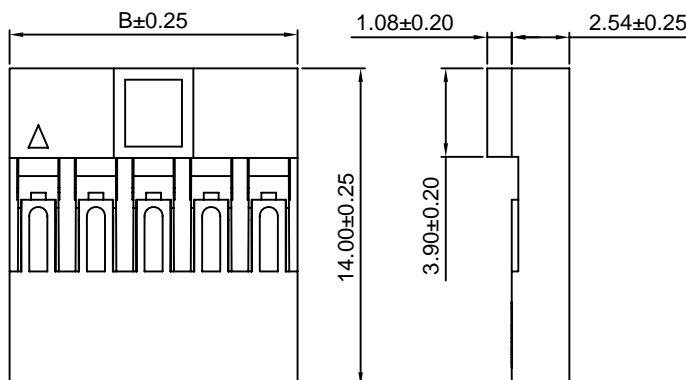
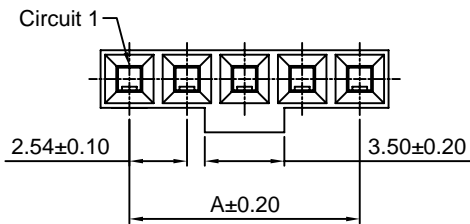
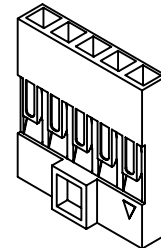

Ordering Information & Dimensions:

| PART NO. | Dimensions | | PART NO. | Dimensions | |
|--------------|------------|-------|--------------|------------|--------|
| | A | B | | A | B |
| A2541H-N-2P | 2.54 | 5.14 | A2541H-N-22P | 53.34 | 55.88 |
| A2541H-N-3P | 5.08 | 7.68 | A2541H-N-23P | 55.88 | 58.42 |
| A2541H-N-4P | 7.62 | 10.22 | A2541H-N-24P | 58.42 | 60.96 |
| A2541H-N-5P | 10.16 | 12.76 | A2541H-N-25P | 60.96 | 63.50 |
| A2541H-N-6P | 12.70 | 15.30 | A2541H-N-26P | 63.50 | 66.04 |
| A2541H-N-7P | 15.24 | 17.84 | A2541H-N-27P | 66.04 | 68.58 |
| A2541H-N-8P | 17.78 | 20.38 | A2541H-N-28P | 68.58 | 71.12 |
| A2541H-N-9P | 20.32 | 22.92 | A2541H-N-29P | 71.12 | 73.66 |
| A2541H-N-10P | 22.86 | 25.46 | A2541H-N-30P | 73.66 | 76.20 |
| A2541H-N-11P | 25.40 | 28.00 | A2541H-N-31P | 76.20 | 78.74 |
| A2541H-N-12P | 27.94 | 30.54 | A2541H-N-32P | 78.74 | 81.28 |
| A2541H-N-13P | 30.48 | 33.08 | A2541H-N-33P | 81.28 | 83.82 |
| A2541H-N-14P | 33.02 | 35.62 | A2541H-N-34P | 83.82 | 86.36 |
| A2541H-N-15P | 35.56 | 38.16 | A2541H-N-35P | 86.36 | 88.90 |
| A2541H-N-16P | 38.10 | 40.72 | A2541H-N-36P | 88.90 | 91.44 |
| A2541H-N-17P | 40.64 | 43.24 | A2541H-N-37P | 91.44 | 93.98 |
| A2541H-N-18P | 43.18 | 45.78 | A2541H-N-38P | 93.98 | 96.52 |
| A2541H-N-19P | 45.72 | 48.34 | A2541H-N-39P | 96.52 | 99.06 |
| A2541H-N-20P | 48.26 | 50.88 | A2541H-N-40P | 99.06 | 101.60 |
| A2541H-N-21P | 50.80 | 53.34 | | | |

Unit: mm

A2541H-N-2

2.54mm Pitch Single Row Housing

Reference Informations:

- *Material:PBT,UL94V-0
- *Suitable CJT A2541 series Terminal
- *Mates with CJT A2541 series Single row Pin Header
- *Color:Black

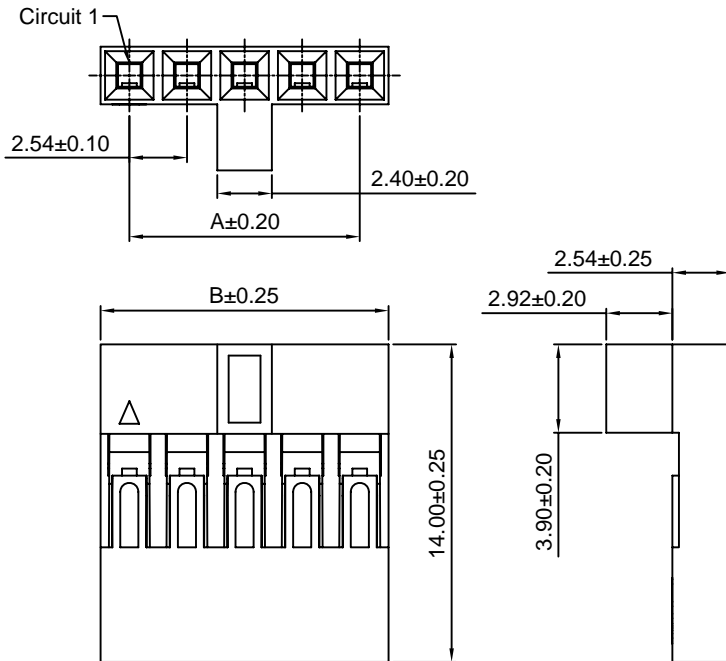
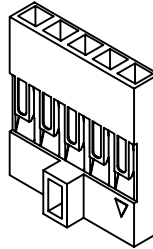

Ordering Information & Dimensions:

| PART NO. | Dimensions | | PART NO. | Dimensions | |
|----------------|------------|-------|----------------|------------|--------|
| | A | B | | A | B |
| A2541H-N-2P-2 | 2.54 | 5.14 | A2541H-N-22P-2 | 53.34 | 55.88 |
| A2541H-N-3P-2 | 5.08 | 7.68 | A2541H-N-23P-2 | 55.88 | 58.42 |
| A2541H-N-4P-2 | 7.62 | 10.22 | A2541H-N-24P-2 | 58.42 | 60.96 |
| A2541H-N-5P-2 | 10.16 | 12.76 | A2541H-N-25P-2 | 60.96 | 63.50 |
| A2541H-N-6P-2 | 12.70 | 15.30 | A2541H-N-26P-2 | 63.50 | 66.04 |
| A2541H-N-7P-2 | 15.24 | 17.84 | A2541H-N-27P-2 | 66.04 | 68.58 |
| A2541H-N-8P-2 | 17.78 | 20.38 | A2541H-N-28P-2 | 68.58 | 71.12 |
| A2541H-N-9P-2 | 20.32 | 22.92 | A2541H-N-29P-2 | 71.12 | 73.66 |
| A2541H-N-10P-2 | 22.86 | 25.46 | A2541H-N-30P-2 | 73.66 | 76.20 |
| A2541H-N-11P-2 | 25.40 | 28.00 | A2541H-N-31P-2 | 76.20 | 78.74 |
| A2541H-N-12P-2 | 27.94 | 30.54 | A2541H-N-32P-2 | 78.74 | 81.28 |
| A2541H-N-13P-2 | 30.48 | 33.08 | A2541H-N-33P-2 | 81.28 | 83.82 |
| A2541H-N-14P-2 | 33.02 | 35.62 | A2541H-N-34P-2 | 83.82 | 86.36 |
| A2541H-N-15P-2 | 35.56 | 38.16 | A2541H-N-35P-2 | 86.36 | 88.90 |
| A2541H-N-16P-2 | 38.10 | 40.72 | A2541H-N-36P-2 | 88.90 | 91.44 |
| A2541H-N-17P-2 | 40.64 | 43.24 | A2541H-N-37P-2 | 91.44 | 93.98 |
| A2541H-N-18P-2 | 43.18 | 45.78 | A2541H-N-38P-2 | 93.98 | 96.52 |
| A2541H-N-19P-2 | 45.72 | 48.34 | A2541H-N-39P-2 | 96.52 | 99.06 |
| A2541H-N-20P-2 | 48.26 | 50.88 | A2541H-N-40P-2 | 99.06 | 101.60 |
| A2541H-N-21P-2 | 50.80 | 53.34 | | | |

Unit: mm

A2541WV

2.54mm Pitch 180° Single Row Pin Header

Reference Informations:

- *Material:Pin:Brass/Gold over Nickel
Insulator:PBT30%GF,UL94V-0
- *Mates with CJT A2541 series Single row Housing
Optional Gold plating available but MOQ requested
- *Color:Black

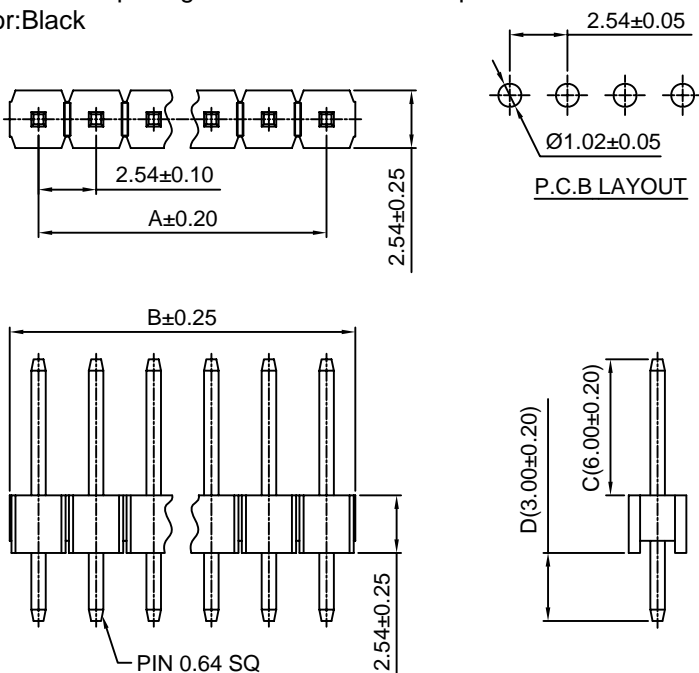
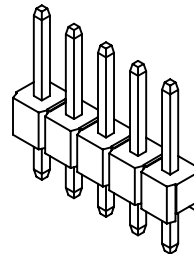

Ordering Information & Dimensions:

| PART NO. | Dimensions | | PART NO. | Dimensions | |
|-------------|------------|-------|-------------|------------|--------|
| | A | B | | A | B |
| A2541WV-2P | 2.54 | 5.08 | A2541WV-22P | 53.34 | 55.88 |
| A2541WV-3P | 5.08 | 7.62 | A2541WV-23P | 55.88 | 58.42 |
| A2541WV-4P | 7.62 | 10.16 | A2541WV-24P | 58.42 | 60.96 |
| A2541WV-5P | 10.16 | 12.70 | A2541WV-25P | 60.96 | 63.50 |
| A2541WV-6P | 12.70 | 15.24 | A2541WV-26P | 63.50 | 66.04 |
| A2541WV-7P | 15.24 | 17.78 | A2541WV-27P | 66.04 | 68.58 |
| A2541WV-8P | 17.78 | 20.32 | A2541WV-28P | 68.58 | 71.12 |
| A2541WV-9P | 20.32 | 22.86 | A2541WV-29P | 71.12 | 73.66 |
| A2541WV-10P | 22.86 | 25.40 | A2541WV-30P | 73.66 | 76.20 |
| A2541WV-11P | 25.40 | 27.94 | A2541WV-31P | 76.20 | 78.74 |
| A2541WV-12P | 27.94 | 30.48 | A2541WV-32P | 78.74 | 81.28 |
| A2541WV-13P | 30.48 | 33.02 | A2541WV-33P | 81.28 | 83.82 |
| A2541WV-14P | 33.02 | 35.56 | A2541WV-34P | 83.82 | 86.36 |
| A2541WV-15P | 35.56 | 38.10 | A2541WV-35P | 86.36 | 88.90 |
| A2541WV-16P | 38.10 | 40.64 | A2541WV-36P | 88.90 | 91.44 |
| A2541WV-17P | 40.64 | 43.18 | A2541WV-37P | 91.44 | 93.98 |
| A2541WV-18P | 43.18 | 45.72 | A2541WV-38P | 93.98 | 96.52 |
| A2541WV-19P | 45.72 | 48.26 | A2541WV-39P | 96.52 | 99.06 |
| A2541WV-20P | 48.26 | 50.80 | A2541WV-40P | 99.06 | 101.60 |
| A2541WV-21P | 50.80 | 53.34 | | | |

Unit: mm

A2541WV-S-A

2.54mm Pitch 180° Single Row Pin Header-SMT A TYPE

Reference Informations:

- *Material:Pin:Brass/Gold over Nickel
Insulator:Nylon 6T , UL94V-0
- *Mates with CJT A2541 series Single row Housing
Optional Gold plating available but MOQ requested
- *Color:Black

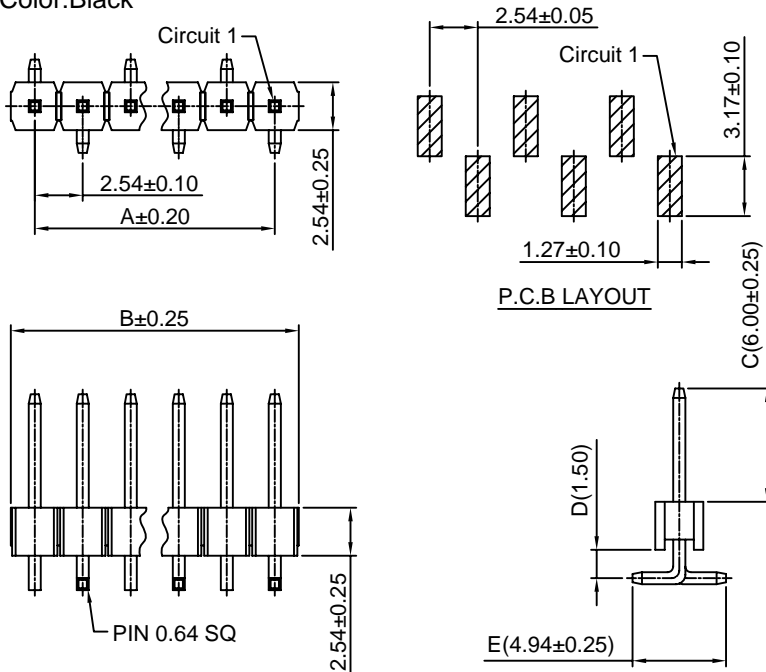
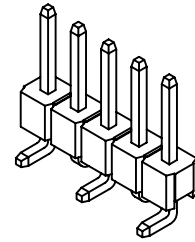

Ordering Information & Dimensions:

| PART NO. | Dimensions | | PART NO. | Dimensions | |
|-----------------|------------|-------|-----------------|------------|--------|
| | A | B | | A | B |
| A2541WV-S-2P-A | 2.54 | 5.08 | A2541WV-S-22P-A | 53.34 | 55.88 |
| A2541WV-S-3P-A | 5.08 | 7.62 | A2541WV-S-23P-A | 55.88 | 58.42 |
| A2541WV-S-4P-A | 7.62 | 10.16 | A2541WV-S-24P-A | 58.42 | 60.96 |
| A2541WV-S-5P-A | 10.16 | 12.70 | A2541WV-S-25P-A | 60.96 | 63.50 |
| A2541WV-S-6P-A | 12.70 | 15.24 | A2541WV-S-26P-A | 63.50 | 66.04 |
| A2541WV-S-7P-A | 15.24 | 17.78 | A2541WV-S-27P-A | 66.04 | 68.58 |
| A2541WV-S-8P-A | 17.78 | 20.32 | A2541WV-S-28P-A | 68.58 | 71.12 |
| A2541WV-S-9P-A | 20.32 | 22.86 | A2541WV-S-29P-A | 71.12 | 73.66 |
| A2541WV-S-10P-A | 22.86 | 25.40 | A2541WV-S-30P-A | 73.66 | 76.20 |
| A2541WV-S-11P-A | 25.40 | 27.94 | A2541WV-S-31P-A | 76.20 | 78.74 |
| A2541WV-S-12P-A | 27.94 | 30.48 | A2541WV-S-32P-A | 78.74 | 81.28 |
| A2541WV-S-13P-A | 30.48 | 33.02 | A2541WV-S-33P-A | 81.28 | 83.82 |
| A2541WV-S-14P-A | 33.02 | 35.56 | A2541WV-S-34P-A | 83.82 | 86.36 |
| A2541WV-S-15P-A | 35.56 | 38.10 | A2541WV-S-35P-A | 86.36 | 88.90 |
| A2541WV-S-16P-A | 38.10 | 40.64 | A2541WV-S-36P-A | 88.90 | 91.44 |
| A2541WV-S-17P-A | 40.64 | 43.18 | A2541WV-S-37P-A | 91.44 | 93.98 |
| A2541WV-S-18P-A | 43.18 | 45.72 | A2541WV-S-38P-A | 93.98 | 96.52 |
| A2541WV-S-19P-A | 45.72 | 48.26 | A2541WV-S-39P-A | 96.52 | 99.06 |
| A2541WV-S-20P-A | 48.26 | 50.80 | A2541WV-S-40P-A | 99.06 | 101.60 |
| A2541WV-S-21P-A | 50.80 | 53.34 | | | |

Unit: mm

A2541WV-S-B

2.54mm Pitch 180° Single Row Pin Header-SMT B TYPE

Reference Informations:

- *Material:Pin:Brass/Gold over Nickel
Insulator:Nylon 6T , UL94V-0
- *Mates with CJT A2541 series Single row Housing
Optional Gold plating available but MOQ requested
- *Color:Black

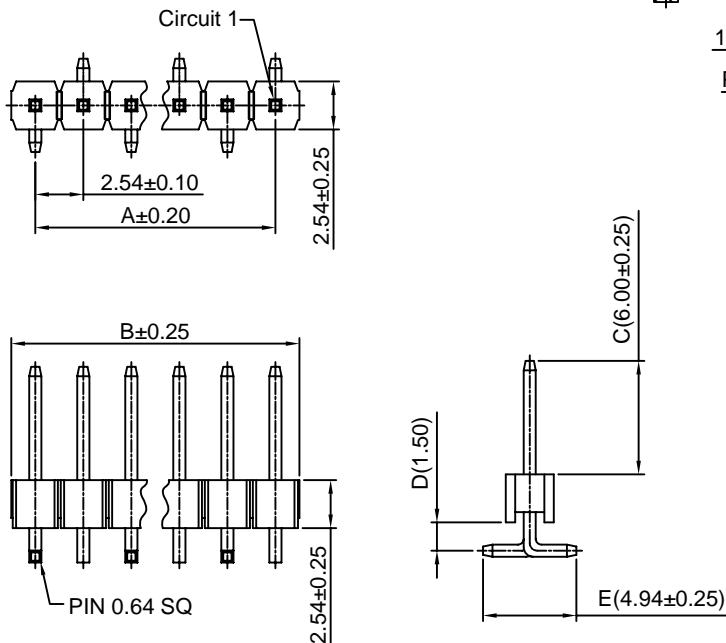

Ordering Information & Dimensions:

| PART NO. | Dimensions | | PART NO. | Dimensions | |
|-----------------|------------|-------|-----------------|------------|--------|
| | A | B | | A | B |
| A2541WV-S-2P-B | 2.54 | 5.08 | A2541WV-S-22P-B | 53.34 | 55.88 |
| A2541WV-S-3P-B | 5.08 | 7.62 | A2541WV-S-23P-B | 55.88 | 58.42 |
| A2541WV-S-4P-B | 7.62 | 10.16 | A2541WV-S-24P-B | 58.42 | 60.96 |
| A2541WV-S-5P-B | 10.16 | 12.70 | A2541WV-S-25P-B | 60.96 | 63.50 |
| A2541WV-S-6P-B | 12.70 | 15.24 | A2541WV-S-26P-B | 63.50 | 66.04 |
| A2541WV-S-7P-B | 15.24 | 17.78 | A2541WV-S-27P-B | 66.04 | 68.58 |
| A2541WV-S-8P-B | 17.78 | 20.32 | A2541WV-S-28P-B | 68.58 | 71.12 |
| A2541WV-S-9P-B | 20.32 | 22.86 | A2541WV-S-29P-B | 71.12 | 73.66 |
| A2541WV-S-10P-B | 22.86 | 25.40 | A2541WV-S-30P-B | 73.66 | 76.20 |
| A2541WV-S-11P-B | 25.40 | 27.94 | A2541WV-S-31P-B | 76.20 | 78.74 |
| A2541WV-S-12P-B | 27.94 | 30.48 | A2541WV-S-32P-B | 78.74 | 81.28 |
| A2541WV-S-13P-B | 30.48 | 33.02 | A2541WV-S-33P-B | 81.28 | 83.82 |
| A2541WV-S-14P-B | 33.02 | 35.56 | A2541WV-S-34P-B | 83.82 | 86.36 |
| A2541WV-S-15P-B | 35.56 | 38.10 | A2541WV-S-35P-B | 86.36 | 88.90 |
| A2541WV-S-16P-B | 38.10 | 40.64 | A2541WV-S-36P-B | 88.90 | 91.44 |
| A2541WV-S-17P-B | 40.64 | 43.18 | A2541WV-S-37P-B | 91.44 | 93.98 |
| A2541WV-S-18P-B | 43.18 | 45.72 | A2541WV-S-38P-B | 93.98 | 96.52 |
| A2541WV-S-19P-B | 45.72 | 48.26 | A2541WV-S-39P-B | 96.52 | 99.06 |
| A2541WV-S-20P-B | 48.26 | 50.80 | A2541WV-S-40P-B | 99.06 | 101.60 |
| A2541WV-S-21P-B | 50.80 | 53.34 | | | |

Unit: mm

A2541WVA

2.54mm Pitch 180° Single Row Pin Header

Reference Informations:

- *Material: Pin: Brass/Gold over Nickel
Insulator: PBT30%GF, UL94V-0
- *Mates with CJT A2541 series Single row Housing
Optional Gold plating available but MOQ requested
- *Color: Black

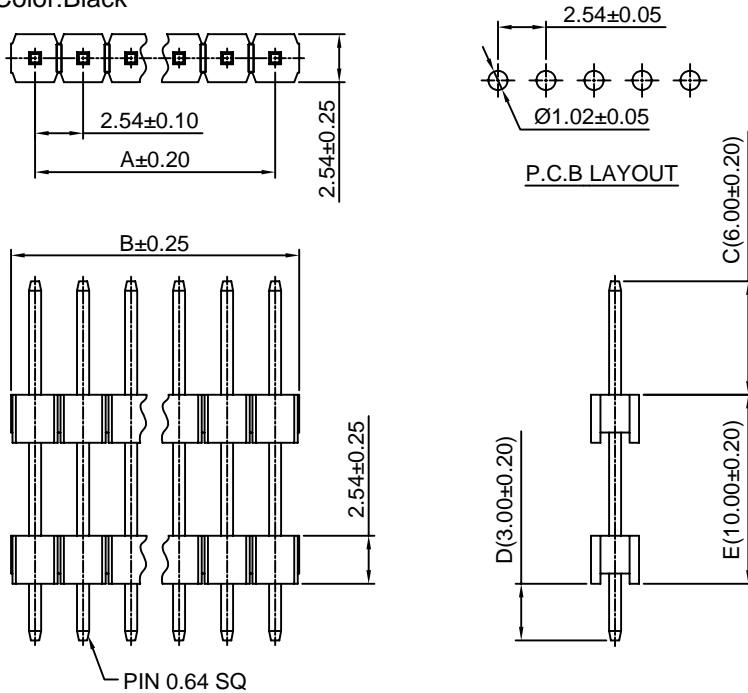
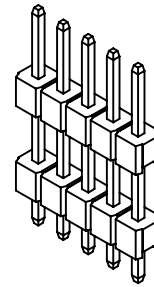

Ordering Information & Dimensions:

| PART NO. | Dimensions | | PART NO. | Dimensions | |
|--------------|------------|-------|--------------|------------|--------|
| | A | B | | A | B |
| A2541WVA-2P | 2.54 | 5.08 | A2541WVA-22P | 53.34 | 55.88 |
| A2541WVA-3P | 5.08 | 7.62 | A2541WVA-23P | 55.88 | 58.42 |
| A2541WVA-4P | 7.62 | 10.16 | A2541WVA-24P | 58.42 | 60.96 |
| A2541WVA-5P | 10.16 | 12.70 | A2541WVA-25P | 60.96 | 63.50 |
| A2541WVA-6P | 12.70 | 15.24 | A2541WVA-26P | 63.50 | 66.04 |
| A2541WVA-7P | 15.24 | 17.78 | A2541WVA-27P | 66.04 | 68.58 |
| A2541WVA-8P | 17.78 | 20.32 | A2541WVA-28P | 68.58 | 71.12 |
| A2541WVA-9P | 20.32 | 22.86 | A2541WVA-29P | 71.12 | 73.66 |
| A2541WVA-10P | 22.86 | 25.40 | A2541WVA-30P | 73.66 | 76.20 |
| A2541WVA-11P | 25.40 | 27.94 | A2541WVA-31P | 76.20 | 78.74 |
| A2541WVA-12P | 27.94 | 30.48 | A2541WVA-32P | 78.74 | 81.28 |
| A2541WVA-13P | 30.48 | 33.02 | A2541WVA-33P | 81.28 | 83.82 |
| A2541WVA-14P | 33.02 | 35.56 | A2541WVA-34P | 83.82 | 86.36 |
| A2541WVA-15P | 35.56 | 38.10 | A2541WVA-35P | 86.36 | 88.90 |
| A2541WVA-16P | 38.10 | 40.64 | A2541WVA-36P | 88.90 | 91.44 |
| A2541WVA-17P | 40.64 | 43.18 | A2541WVA-37P | 91.44 | 93.98 |
| A2541WVA-18P | 43.18 | 45.72 | A2541WVA-38P | 93.98 | 96.52 |
| A2541WVA-19P | 45.72 | 48.26 | A2541WVA-39P | 96.52 | 99.06 |
| A2541WVA-20P | 48.26 | 50.80 | A2541WVA-40P | 99.06 | 101.60 |
| A2541WVA-21P | 50.80 | 53.34 | | | |

Unit: mm

A2541WVA-S-A

2.54mm Pitch 180° Single Row Pin Header-SMT A TYPE

Reference Informations:

- *Material: Pin: Brass/Gold over Nickel
Insulator: Nylon 6T, UL94V-0
- *Mates with CJT A2541 series Single row Housing
Optional Gold plating available but MOQ requested
- *Color: Black

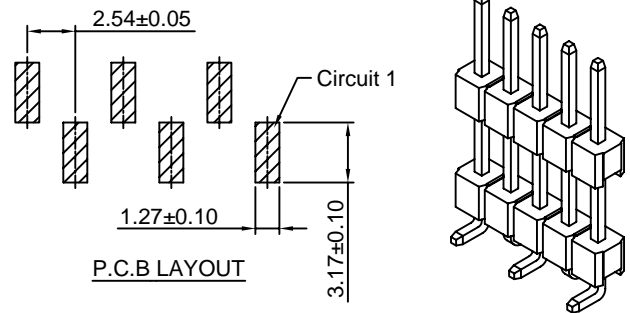

Ordering Information & Dimensions:

| PART NO. | Dimensions | | PART NO. | Dimensions | |
|------------------|------------|-------|------------------|------------|--------|
| | A | B | | A | B |
| A2541WVA-S-2P-A | 2.54 | 5.08 | A2541WVA-S-22P-A | 53.34 | 55.88 |
| A2541WVA-S-3P-A | 5.08 | 7.62 | A2541WVA-S-23P-A | 55.88 | 58.42 |
| A2541WVA-S-4P-A | 7.62 | 10.16 | A2541WVA-S-24P-A | 58.42 | 60.96 |
| A2541WVA-S-5P-A | 10.16 | 12.70 | A2541WVA-S-25P-A | 60.96 | 63.50 |
| A2541WVA-S-6P-A | 12.70 | 15.24 | A2541WVA-S-26P-A | 63.50 | 66.04 |
| A2541WVA-S-7P-A | 15.24 | 17.78 | A2541WVA-S-27P-A | 66.04 | 68.58 |
| A2541WVA-S-8P-A | 17.78 | 20.32 | A2541WVA-S-28P-A | 68.58 | 71.12 |
| A2541WVA-S-9P-A | 20.32 | 22.86 | A2541WVA-S-29P-A | 71.12 | 73.66 |
| A2541WVA-S-10P-A | 22.86 | 25.40 | A2541WVA-S-30P-A | 73.66 | 76.20 |
| A2541WVA-S-11P-A | 25.40 | 27.94 | A2541WVA-S-31P-A | 76.20 | 78.74 |
| A2541WVA-S-12P-A | 27.94 | 30.48 | A2541WVA-S-32P-A | 78.74 | 81.28 |
| A2541WVA-S-13P-A | 30.48 | 33.02 | A2541WVA-S-33P-A | 81.28 | 83.82 |
| A2541WVA-S-14P-A | 33.02 | 35.56 | A2541WVA-S-34P-A | 83.82 | 86.36 |
| A2541WVA-S-15P-A | 35.56 | 38.10 | A2541WVA-S-35P-A | 86.36 | 88.90 |
| A2541WVA-S-16P-A | 38.10 | 40.64 | A2541WVA-S-36P-A | 88.90 | 91.44 |
| A2541WVA-S-17P-A | 40.64 | 43.18 | A2541WVA-S-37P-A | 91.44 | 93.98 |
| A2541WVA-S-18P-A | 43.18 | 45.72 | A2541WVA-S-38P-A | 93.98 | 96.52 |
| A2541WVA-S-19P-A | 45.72 | 48.26 | A2541WVA-S-39P-A | 96.52 | 99.06 |
| A2541WVA-S-20P-A | 48.26 | 50.80 | A2541WVA-S-40P-A | 99.06 | 101.60 |
| A2541WVA-S-21P-A | 50.80 | 53.34 | | | |

Unit: mm

A2541WVA-S-B

2.54mm Pitch 180° Single Row Pin Header-SMT B TYPE

Reference Informations:

- *Material: Pin: Brass/Gold over Nickel
Insulator: Nylon 6T, UL94V-0
- *Mates with CJT A2541 series Single row Housing
Optional Gold plating available but MOQ requested
- *Color: Black

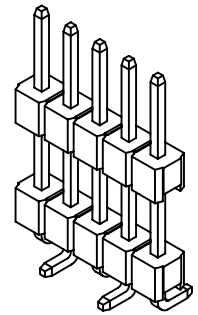
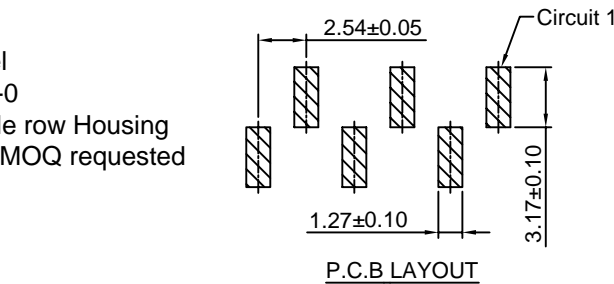
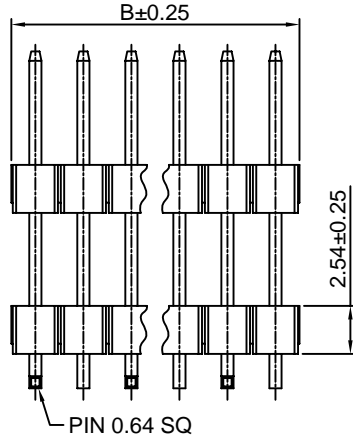
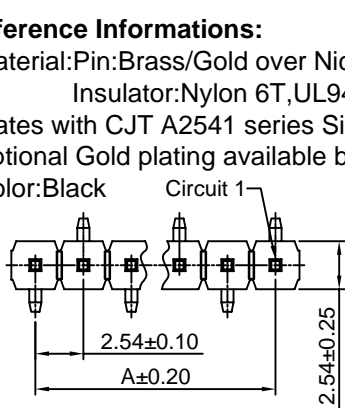

Ordering Information & Dimensions:

| PART NO. | Dimensions | | PART NO. | Dimensions | |
|------------------|------------|-------|------------------|------------|--------|
| | A | B | | A | B |
| A2541WVA-S-2P-B | 2.54 | 5.08 | A2541WVA-S-22P-B | 53.34 | 55.88 |
| A2541WVA-S-3P-B | 5.08 | 7.62 | A2541WVA-S-23P-B | 55.88 | 58.42 |
| A2541WVA-S-4P-B | 7.62 | 10.16 | A2541WVA-S-24P-B | 58.42 | 60.96 |
| A2541WVA-S-5P-B | 10.16 | 12.70 | A2541WVA-S-25P-B | 60.96 | 63.50 |
| A2541WVA-S-6P-B | 12.70 | 15.24 | A2541WVA-S-26P-B | 63.50 | 66.04 |
| A2541WVA-S-7P-B | 15.24 | 17.78 | A2541WVA-S-27P-B | 66.04 | 68.58 |
| A2541WVA-S-8P-B | 17.78 | 20.32 | A2541WVA-S-28P-B | 68.58 | 71.12 |
| A2541WVA-S-9P-B | 20.32 | 22.86 | A2541WVA-S-29P-B | 71.12 | 73.66 |
| A2541WVA-S-10P-B | 22.86 | 25.40 | A2541WVA-S-30P-B | 73.66 | 76.20 |
| A2541WVA-S-11P-B | 25.40 | 27.94 | A2541WVA-S-31P-B | 76.20 | 78.74 |
| A2541WVA-S-12P-B | 27.94 | 30.48 | A2541WVA-S-32P-B | 78.74 | 81.28 |
| A2541WVA-S-13P-B | 30.48 | 33.02 | A2541WVA-S-33P-B | 81.28 | 83.82 |
| A2541WVA-S-14P-B | 33.02 | 35.56 | A2541WVA-S-34P-B | 83.82 | 86.36 |
| A2541WVA-S-15P-B | 35.56 | 38.10 | A2541WVA-S-35P-B | 86.36 | 88.90 |
| A2541WVA-S-16P-B | 38.10 | 40.64 | A2541WVA-S-36P-B | 88.90 | 91.44 |
| A2541WVA-S-17P-B | 40.64 | 43.18 | A2541WVA-S-37P-B | 91.44 | 93.98 |
| A2541WVA-S-18P-B | 43.18 | 45.72 | A2541WVA-S-38P-B | 93.98 | 96.52 |
| A2541WVA-S-19P-B | 45.72 | 48.26 | A2541WVA-S-39P-B | 96.52 | 99.06 |
| A2541WVA-S-20P-B | 48.26 | 50.80 | A2541WVA-S-40P-B | 99.06 | 101.60 |
| A2541WVA-S-21P-B | 50.80 | 53.34 | | | |

Unit: mm

A2541WR

2.54mm Pitch 90° Single Row Pin Header

Reference Informations:

- *Material: Pin: Brass/Gold over Nickel
Insulator: PBT30%GF, UL94V-0
- *Mates with CJT A2541 series Single row Housing
Optional Gold plating available but MOQ requested
- *Color: Black

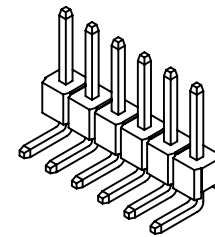
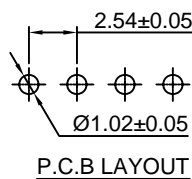
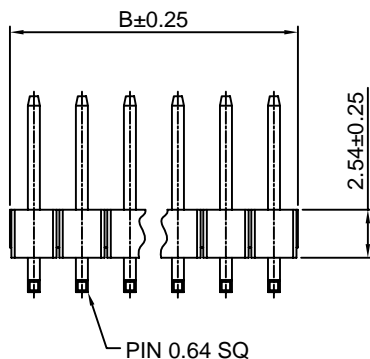
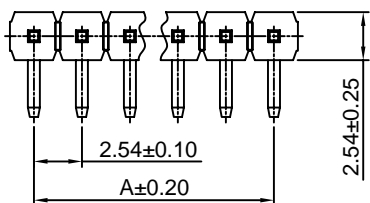

Ordering Information & Dimensions:

| PART NO. | Dimensions | | PART NO. | Dimensions | |
|-------------|------------|-------|-------------|------------|--------|
| | A | B | | A | B |
| A2541WR-2P | 2.54 | 5.08 | A2541WR-22P | 53.34 | 55.88 |
| A2541WR-3P | 5.08 | 7.62 | A2541WR-23P | 55.88 | 58.42 |
| A2541WR-4P | 7.62 | 10.16 | A2541WR-24P | 58.42 | 60.96 |
| A2541WR-5P | 10.16 | 12.70 | A2541WR-25P | 60.96 | 63.50 |
| A2541WR-6P | 12.70 | 15.24 | A2541WR-26P | 63.50 | 66.04 |
| A2541WR-7P | 15.24 | 17.78 | A2541WR-27P | 66.04 | 68.58 |
| A2541WR-8P | 17.78 | 20.32 | A2541WR-28P | 68.58 | 71.12 |
| A2541WR-9P | 20.32 | 22.86 | A2541WR-29P | 71.12 | 73.66 |
| A2541WR-10P | 22.86 | 25.40 | A2541WR-30P | 73.66 | 76.20 |
| A2541WR-11P | 25.40 | 27.94 | A2541WR-31P | 76.20 | 78.74 |
| A2541WR-12P | 27.94 | 30.48 | A2541WR-32P | 78.74 | 81.28 |
| A2541WR-13P | 30.48 | 33.02 | A2541WR-33P | 81.28 | 83.82 |
| A2541WR-14P | 33.02 | 35.56 | A2541WR-34P | 83.82 | 86.36 |
| A2541WR-15P | 35.56 | 38.10 | A2541WR-35P | 86.36 | 88.90 |
| A2541WR-16P | 38.10 | 40.64 | A2541WR-36P | 88.90 | 91.44 |
| A2541WR-17P | 40.64 | 43.18 | A2541WR-37P | 91.44 | 93.98 |
| A2541WR-18P | 43.18 | 45.72 | A2541WR-38P | 93.98 | 96.52 |
| A2541WR-19P | 45.72 | 48.26 | A2541WR-39P | 96.52 | 99.06 |
| A2541WR-20P | 48.26 | 50.80 | A2541WR-40P | 99.06 | 101.60 |
| A2541WR-21P | 50.80 | 53.34 | | | |

Unit: mm

A2541WRA

2.54mm Pitch 90° Single Row Pin Header

Reference Informations:

- *Material: Pin: Brass/Gold over Nickel
Insulator: PBT30%GF, UL94V-0
- *Mates with CJT A2541 series Single row Housing
Optional Gold plating available but MOQ requested
- *Color: Black

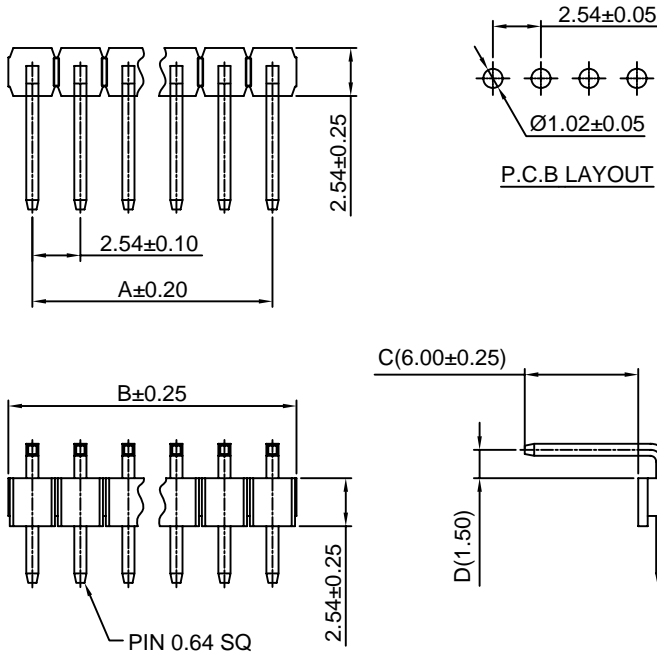
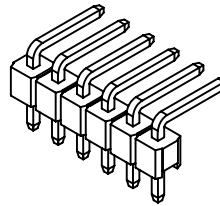

Ordering Information & Dimensions:

| PART NO. | Dimensions | | PART NO. | Dimensions | |
|--------------|------------|-------|--------------|------------|--------|
| | A | B | | A | B |
| A2541WRA-2P | 2.54 | 5.08 | A2541WRA-22P | 53.34 | 55.88 |
| A2541WRA-3P | 5.08 | 7.62 | A2541WRA-23P | 55.88 | 58.42 |
| A2541WRA-4P | 7.62 | 10.16 | A2541WRA-24P | 58.42 | 60.96 |
| A2541WRA-5P | 10.16 | 12.70 | A2541WRA-25P | 60.96 | 63.50 |
| A2541WRA-6P | 12.70 | 15.24 | A2541WRA-26P | 63.50 | 66.04 |
| A2541WRA-7P | 15.24 | 17.78 | A2541WRA-27P | 66.04 | 68.58 |
| A2541WRA-8P | 17.78 | 20.32 | A2541WRA-28P | 68.58 | 71.12 |
| A2541WRA-9P | 20.32 | 22.86 | A2541WRA-29P | 71.12 | 73.66 |
| A2541WRA-10P | 22.86 | 25.40 | A2541WRA-30P | 73.66 | 76.20 |
| A2541WRA-11P | 25.40 | 27.94 | A2541WRA-31P | 76.20 | 78.74 |
| A2541WRA-12P | 27.94 | 30.48 | A2541WRA-32P | 78.74 | 81.28 |
| A2541WRA-13P | 30.48 | 33.02 | A2541WRA-33P | 81.28 | 83.82 |
| A2541WRA-14P | 33.02 | 35.56 | A2541WRA-34P | 83.82 | 86.36 |
| A2541WRA-15P | 35.56 | 38.10 | A2541WRA-35P | 86.36 | 88.90 |
| A2541WRA-16P | 38.10 | 40.64 | A2541WRA-36P | 88.90 | 91.44 |
| A2541WRA-17P | 40.64 | 43.18 | A2541WRA-37P | 91.44 | 93.98 |
| A2541WRA-18P | 43.18 | 45.72 | A2541WRA-38P | 93.98 | 96.52 |
| A2541WRA-19P | 45.72 | 48.26 | A2541WRA-39P | 96.52 | 99.06 |
| A2541WRA-20P | 48.26 | 50.80 | A2541WRA-40P | 99.06 | 101.60 |
| A2541WRA-21P | 50.80 | 53.34 | | | |

Unit: mm

A2541H-2

2.54mm Pitch Dual Row Housing

Reference Informations:

- *Material: PBT15%GF, UL94V-0
- *Suitable CJT A2541 series Terminal or A2541M series Terminal
- *Mates with CJT A2541 series Dual row Pin Header
- *Color: Black

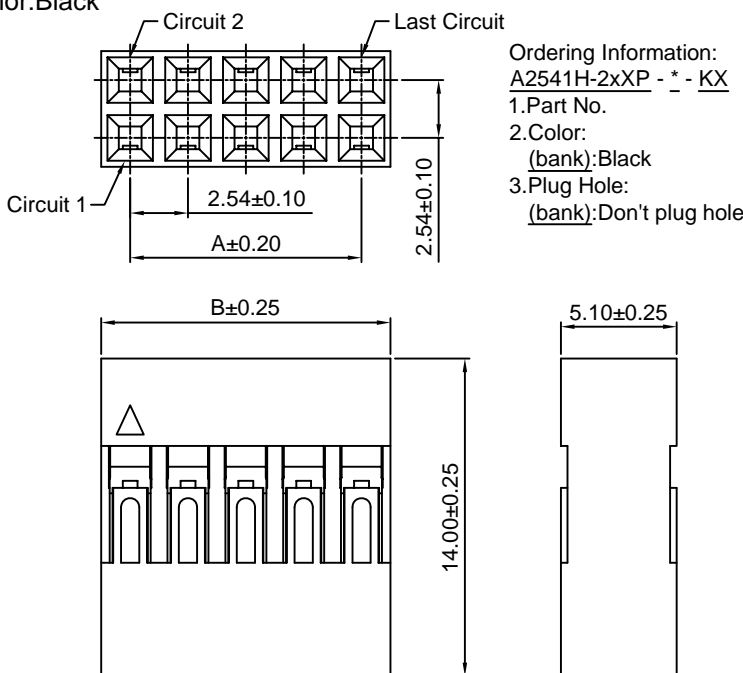
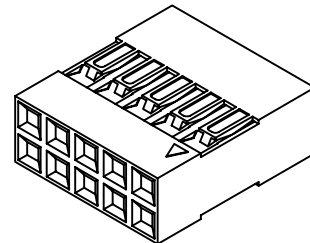

Ordering Information & Dimensions:

| PART NO. | Dimensions | | PART NO. | Dimensions | |
|--------------|------------|-------|--------------|------------|--------|
| | A | B | | A | B |
| A2541H-2x2P | 2.54 | 5.08 | A2541H-2x22P | 53.34 | 55.88 |
| A2541H-2x3P | 5.08 | 7.62 | A2541H-2x23P | 55.88 | 58.42 |
| A2541H-2x4P | 7.62 | 10.16 | A2541H-2x24P | 58.42 | 60.96 |
| A2541H-2x5P | 10.16 | 12.70 | A2541H-2x25P | 60.96 | 63.50 |
| A2541H-2x6P | 12.70 | 15.24 | A2541H-2x26P | 63.50 | 66.04 |
| A2541H-2x7P | 15.24 | 17.78 | A2541H-2x27P | 66.04 | 68.58 |
| A2541H-2x8P | 17.78 | 20.32 | A2541H-2x28P | 68.58 | 71.12 |
| A2541H-2x9P | 20.32 | 22.86 | A2541H-2x29P | 71.12 | 73.66 |
| A2541H-2x10P | 22.86 | 25.40 | A2541H-2x30P | 73.66 | 76.20 |
| A2541H-2x11P | 25.40 | 27.94 | A2541H-2x31P | 76.20 | 78.74 |
| A2541H-2x12P | 27.94 | 30.48 | A2541H-2x32P | 78.74 | 81.28 |
| A2541H-2x13P | 30.48 | 33.02 | A2541H-2x33P | 81.28 | 83.82 |
| A2541H-2x14P | 33.02 | 35.56 | A2541H-2x34P | 83.82 | 86.36 |
| A2541H-2x15P | 35.56 | 38.10 | A2541H-2x35P | 86.36 | 88.90 |
| A2541H-2x16P | 38.10 | 40.64 | A2541H-2x36P | 88.90 | 91.44 |
| A2541H-2x17P | 40.64 | 43.18 | A2541H-2x37P | 91.44 | 93.98 |
| A2541H-2x18P | 43.18 | 45.72 | A2541H-2x38P | 93.98 | 96.52 |
| A2541H-2x19P | 45.72 | 48.26 | A2541H-2x39P | 96.52 | 99.06 |
| A2541H-2x20P | 48.26 | 50.80 | A2541H-2x40P | 99.06 | 101.60 |
| A2541H-2x21P | 50.80 | 53.34 | | | |

Unit: mm

A2541H-N-2

2.54mm Pitch Dual Row Housing

Reference Informations:

- *Material:PBT15%GF,UL94V-0
- *Suitable CJT A2541 series Terminal
- *Mates with CJT A2541 series dual row Pin Header or A2541series dual row Box Header
- *Color:Black

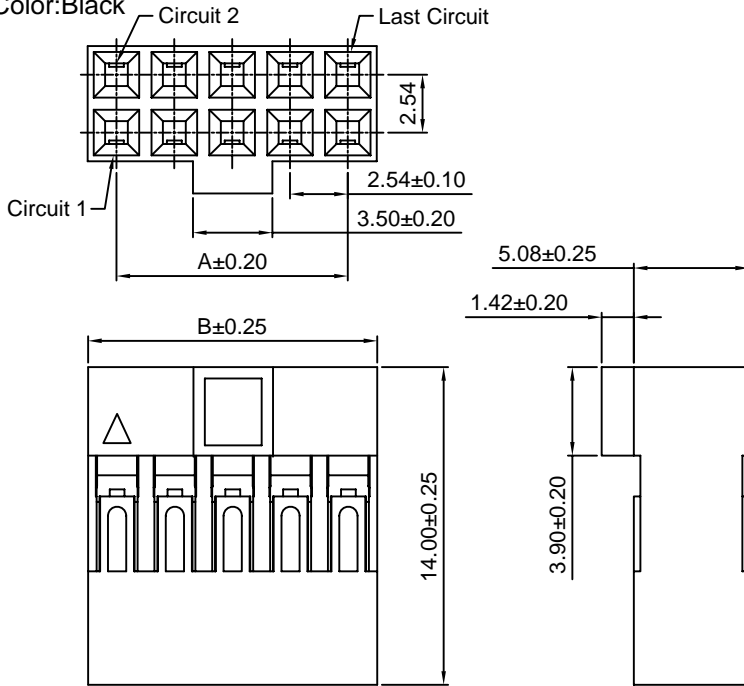
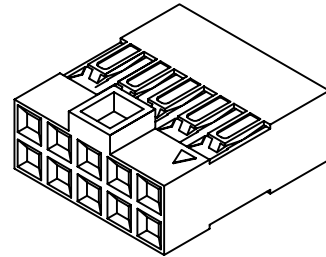

Ordering Information & Dimensions:

| PART NO. | Dimensions | | PART NO. | Dimensions | |
|----------------|------------|-------|----------------|------------|--------|
| | A | B | | A | B |
| A2541H-N-2x2P | 2.54 | 5.08 | A2541H-N-2x22P | 53.34 | 55.88 |
| A2541H-N-2x3P | 5.08 | 7.62 | A2541H-N-2x23P | 55.88 | 58.42 |
| A2541H-N-2x4P | 7.62 | 10.16 | A2541H-N-2x24P | 58.42 | 60.96 |
| A2541H-N-2x5P | 10.16 | 12.70 | A2541H-N-2x25P | 60.96 | 63.50 |
| A2541H-N-2x6P | 12.70 | 15.24 | A2541H-N-2x26P | 63.50 | 66.04 |
| A2541H-N-2x7P | 15.24 | 17.78 | A2541H-N-2x27P | 66.04 | 68.58 |
| A2541H-N-2x8P | 17.78 | 20.32 | A2541H-N-2x28P | 68.58 | 71.12 |
| A2541H-N-2x9P | 20.32 | 22.86 | A2541H-N-2x29P | 71.12 | 73.66 |
| A2541H-N-2x10P | 22.86 | 25.40 | A2541H-N-2x30P | 73.66 | 76.20 |
| A2541H-N-2x11P | 25.40 | 27.94 | A2541H-N-2x31P | 76.20 | 78.74 |
| A2541H-N-2x12P | 27.94 | 30.48 | A2541H-N-2x32P | 78.74 | 81.28 |
| A2541H-N-2x13P | 30.48 | 33.02 | A2541H-N-2x33P | 81.28 | 83.82 |
| A2541H-N-2x14P | 33.02 | 35.56 | A2541H-N-2x34P | 83.82 | 86.36 |
| A2541H-N-2x15P | 35.56 | 38.10 | A2541H-N-2x35P | 86.36 | 88.90 |
| A2541H-N-2x16P | 38.10 | 40.64 | A2541H-N-2x36P | 88.90 | 91.44 |
| A2541H-N-2x17P | 40.64 | 43.18 | A2541H-N-2x37P | 91.44 | 93.98 |
| A2541H-N-2x18P | 43.18 | 45.72 | A2541H-N-2x38P | 93.98 | 96.52 |
| A2541H-N-2x19P | 45.72 | 48.26 | A2541H-N-2x39P | 96.52 | 99.06 |
| A2541H-N-2x20P | 48.26 | 50.80 | A2541H-N-2x40P | 99.06 | 101.60 |
| A2541H-N-2x21P | 50.80 | 53.34 | | | |

Unit: mm

A2541H-N-2-2

2.54mm Pitch Dual Row Housing

Reference Informations:

- *Material:PBT15%GF,UL94V-0
- *Suitable CJT A2541 series Terminal
- *Mates with CJT A2541 series dual row Pin Header or A2541series dual row Box Header
- *Color:Black

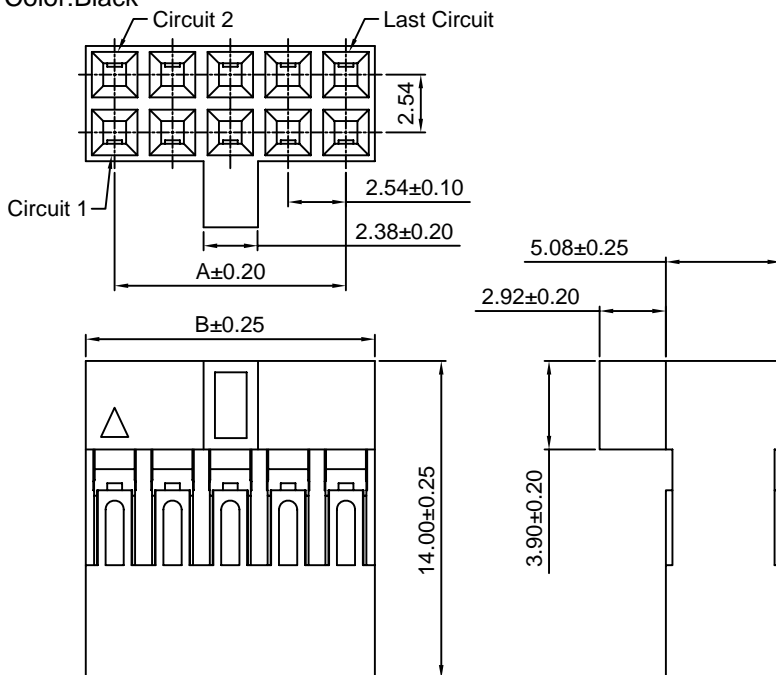
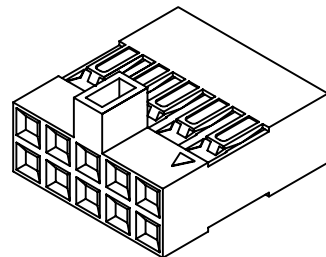

Ordering Information & Dimensions:

| PART NO. | Dimensions | | PART NO. | Dimensions | |
|------------------|------------|-------|------------------|------------|--------|
| | A | B | | A | B |
| A2541H-N-2x2P-2 | 2.54 | 5.08 | A2541H-N-2x22P-2 | 53.34 | 55.88 |
| A2541H-N-2x3P-2 | 5.08 | 7.62 | A2541H-N-2x23P-2 | 55.88 | 58.42 |
| A2541H-N-2x4P-2 | 7.62 | 10.16 | A2541H-N-2x24P-2 | 58.42 | 60.96 |
| A2541H-N-2x5P-2 | 10.16 | 12.70 | A2541H-N-2x25P-2 | 60.96 | 63.50 |
| A2541H-N-2x6P-2 | 12.70 | 15.24 | A2541H-N-2x26P-2 | 63.50 | 66.04 |
| A2541H-N-2x7P-2 | 15.24 | 17.78 | A2541H-N-2x27P-2 | 66.04 | 68.58 |
| A2541H-N-2x8P-2 | 17.78 | 20.32 | A2541H-N-2x28P-2 | 68.58 | 71.12 |
| A2541H-N-2x9P-2 | 20.32 | 22.86 | A2541H-N-2x29P-2 | 71.12 | 73.66 |
| A2541H-N-2x10P-2 | 22.86 | 25.40 | A2541H-N-2x30P-2 | 73.66 | 76.20 |
| A2541H-N-2x11P-2 | 25.40 | 27.94 | A2541H-N-2x31P-2 | 76.20 | 78.74 |
| A2541H-N-2x12P-2 | 27.94 | 30.48 | A2541H-N-2x32P-2 | 78.74 | 81.28 |
| A2541H-N-2x13P-2 | 30.48 | 33.02 | A2541H-N-2x33P-2 | 81.28 | 83.82 |
| A2541H-N-2x14P-2 | 33.02 | 35.56 | A2541H-N-2x34P-2 | 83.82 | 86.36 |
| A2541H-N-2x15P-2 | 35.56 | 38.10 | A2541H-N-2x35P-2 | 86.36 | 88.90 |
| A2541H-N-2x16P-2 | 38.10 | 40.64 | A2541H-N-2x36P-2 | 88.90 | 91.44 |
| A2541H-N-2x17P-2 | 40.64 | 43.18 | A2541H-N-2x37P-2 | 91.44 | 93.98 |
| A2541H-N-2x18P-2 | 43.18 | 45.72 | A2541H-N-2x38P-2 | 93.98 | 96.52 |
| A2541H-N-2x19P-2 | 45.72 | 48.26 | A2541H-N-2x39P-2 | 96.52 | 99.06 |
| A2541H-N-2x20P-2 | 48.26 | 50.80 | A2541H-N-2x40P-2 | 99.06 | 101.60 |
| A2541H-N-2x21P-2 | 50.80 | 53.34 | | | |

Unit: mm

A2541WV-2

2.54mm Pitch 180° Dual Row Pin Header

Reference Informations:

- *Material: Pin: Brass/Gold over Nickel
Insulator: PBT30%GF, UL94V-0
- *Mates with CJT A2541 series dual row Housing
Optional Gold plating available but MOQ requested
- *Color: Black

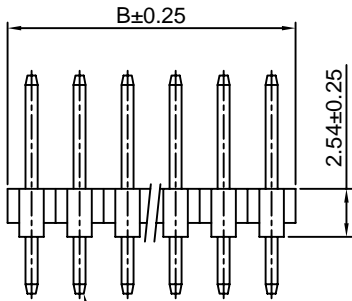
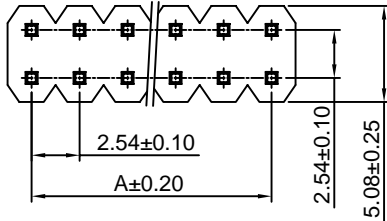

PIN 0.64 SQ

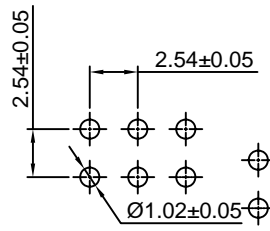

P.C.B LAYOUT

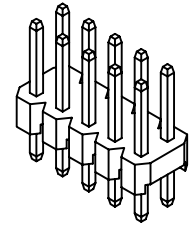

Ordering Information & Dimensions:

| PART NO. | Dimensions | | PART NO. | Dimensions | |
|---------------|------------|-------|---------------|------------|--------|
| | A | B | | A | B |
| A2541WV-2x2P | 2.54 | 5.08 | A2541WV-2x22P | 53.34 | 55.88 |
| A2541WV-2x3P | 5.08 | 7.62 | A2541WV-2x23P | 55.88 | 58.42 |
| A2541WV-2x4P | 7.62 | 10.16 | A2541WV-2x24P | 58.42 | 60.96 |
| A2541WV-2x5P | 10.16 | 12.70 | A2541WV-2x25P | 60.96 | 63.50 |
| A2541WV-2x6P | 12.70 | 15.24 | A2541WV-2x26P | 63.50 | 66.04 |
| A2541WV-2x7P | 15.24 | 17.78 | A2541WV-2x27P | 66.04 | 68.58 |
| A2541WV-2x8P | 17.78 | 20.32 | A2541WV-2x28P | 68.58 | 71.12 |
| A2541WV-2x9P | 20.32 | 22.86 | A2541WV-2x29P | 71.12 | 73.66 |
| A2541WV-2x10P | 22.86 | 25.40 | A2541WV-2x30P | 73.66 | 76.20 |
| A2541WV-2x11P | 25.40 | 27.94 | A2541WV-2x31P | 76.20 | 78.74 |
| A2541WV-2x12P | 27.94 | 30.48 | A2541WV-2x32P | 78.74 | 81.28 |
| A2541WV-2x13P | 30.48 | 33.02 | A2541WV-2x33P | 81.28 | 83.82 |
| A2541WV-2x14P | 33.02 | 35.56 | A2541WV-2x34P | 83.82 | 86.36 |
| A2541WV-2x15P | 35.56 | 38.10 | A2541WV-2x35P | 86.36 | 88.90 |
| A2541WV-2x16P | 38.10 | 40.64 | A2541WV-2x36P | 88.90 | 91.44 |
| A2541WV-2x17P | 40.64 | 43.18 | A2541WV-2x37P | 91.44 | 93.98 |
| A2541WV-2x18P | 43.18 | 45.72 | A2541WV-2x38P | 93.98 | 96.52 |
| A2541WV-2x19P | 45.72 | 48.26 | A2541WV-2x39P | 96.52 | 99.06 |
| A2541WV-2x20P | 48.26 | 50.80 | A2541WV-2x40P | 99.06 | 101.60 |
| A2541WV-2x21P | 50.80 | 53.34 | | | |

Unit: mm

A2541WV-S-2

2.54mm Pitch 180° Dual Row Pin Header-SMT TYPE

Reference Informations:

- *Material: Pin: Brass/Gold over Nickel
Insulator: Nylon 6T, UL94V-0
- *Mates with CJT A2541 series dual row Housing
Optional Gold plating available but MOQ requested
- *Color: Black

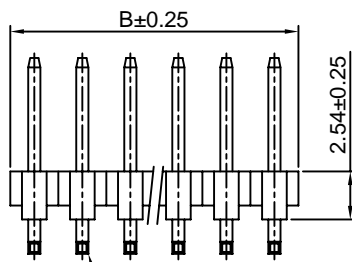
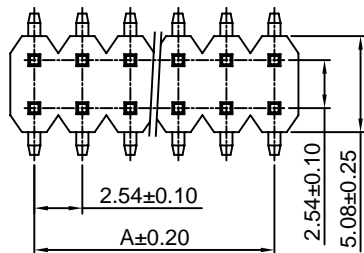

PIN 0.64 SQ

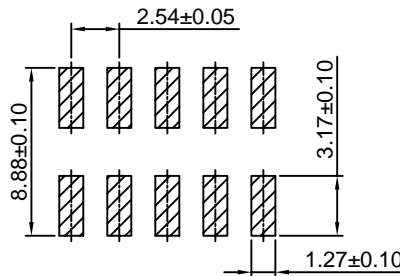

P.C.B LAYOUT

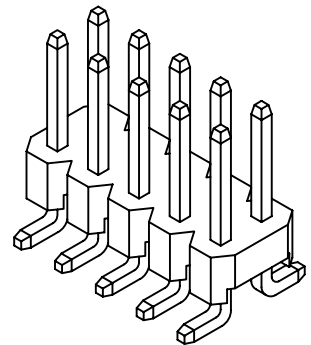

Ordering Information & Dimensions:

| PART NO. | Dimensions | | PART NO. | Dimensions | |
|-----------------|------------|-------|-----------------|------------|--------|
| | A | B | | A | B |
| A2541WV-S-2x2P | 2.54 | 5.08 | A2541WV-S-2x22P | 53.34 | 55.88 |
| A2541WV-S-2x3P | 5.08 | 7.62 | A2541WV-S-2x23P | 55.88 | 58.42 |
| A2541WV-S-2x4P | 7.62 | 10.16 | A2541WV-S-2x24P | 58.42 | 60.96 |
| A2541WV-S-2x5P | 10.16 | 12.70 | A2541WV-S-2x25P | 60.96 | 63.50 |
| A2541WV-S-2x6P | 12.70 | 15.24 | A2541WV-S-2x26P | 63.50 | 66.04 |
| A2541WV-S-2x7P | 15.24 | 17.78 | A2541WV-S-2x27P | 66.04 | 68.58 |
| A2541WV-S-2x8P | 17.78 | 20.32 | A2541WV-S-2x28P | 68.58 | 71.12 |
| A2541WV-S-2x9P | 20.32 | 22.86 | A2541WV-S-2x29P | 71.12 | 73.66 |
| A2541WV-S-2x10P | 22.86 | 25.40 | A2541WV-S-2x30P | 73.66 | 76.20 |
| A2541WV-S-2x11P | 25.40 | 27.94 | A2541WV-S-2x31P | 76.20 | 78.74 |
| A2541WV-S-2x12P | 27.94 | 30.48 | A2541WV-S-2x32P | 78.74 | 81.28 |
| A2541WV-S-2x13P | 30.48 | 33.02 | A2541WV-S-2x33P | 81.28 | 83.82 |
| A2541WV-S-2x14P | 33.02 | 35.56 | A2541WV-S-2x34P | 83.82 | 86.36 |
| A2541WV-S-2x15P | 35.56 | 38.10 | A2541WV-S-2x35P | 86.36 | 88.90 |
| A2541WV-S-2x16P | 38.10 | 40.64 | A2541WV-S-2x36P | 88.90 | 91.44 |
| A2541WV-S-2x17P | 40.64 | 43.18 | A2541WV-S-2x37P | 91.44 | 93.98 |
| A2541WV-S-2x18P | 43.18 | 45.72 | A2541WV-S-2x38P | 93.98 | 96.52 |
| A2541WV-S-2x19P | 45.72 | 48.26 | A2541WV-S-2x39P | 96.52 | 99.06 |
| A2541WV-S-2x20P | 48.26 | 50.80 | A2541WV-S-2x40P | 99.06 | 101.60 |
| A2541WV-S-2x21P | 50.80 | 53.34 | | | |

Unit: mm

A2541WVA-2

2.54mm Pitch 180° Dual Row Pin Header

Reference Informations:

- *Material: Pin: Brass/Gold over Nickel
Insulator: PBT30%GF, UL94V-0
- *Mates with CJT A2541 series dual row Housing
Optional Gold plating available but MOQ requested
- *Color: Black

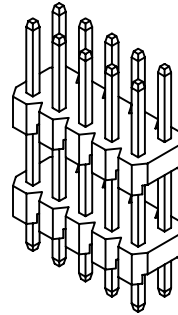
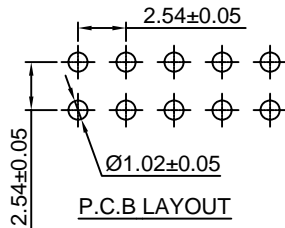
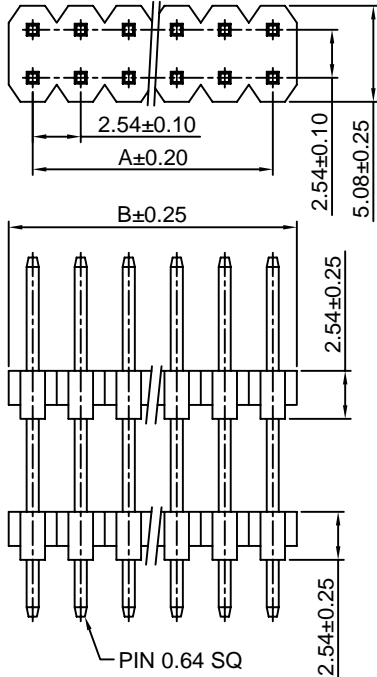

Ordering Information & Dimensions:

| PART NO. | Dimensions | | PART NO. | Dimensions | |
|----------------|------------|-------|----------------|------------|--------|
| | A | B | | A | B |
| A2541WVA-2x2P | 2.54 | 5.08 | A2541WVA-2x22P | 53.34 | 55.88 |
| A2541WVA-2x3P | 5.08 | 7.62 | A2541WVA-2x23P | 55.88 | 58.42 |
| A2541WVA-2x4P | 7.62 | 10.16 | A2541WVA-2x24P | 58.42 | 60.96 |
| A2541WVA-2x5P | 10.16 | 12.70 | A2541WVA-2x25P | 60.96 | 63.50 |
| A2541WVA-2x6P | 12.70 | 15.24 | A2541WVA-2x26P | 63.50 | 66.04 |
| A2541WVA-2x7P | 15.24 | 17.78 | A2541WVA-2x27P | 66.04 | 68.58 |
| A2541WVA-2x8P | 17.78 | 20.32 | A2541WVA-2x28P | 68.58 | 71.12 |
| A2541WVA-2x9P | 20.32 | 22.86 | A2541WVA-2x29P | 71.12 | 73.66 |
| A2541WVA-2x10P | 22.86 | 25.40 | A2541WVA-2x30P | 73.66 | 76.20 |
| A2541WVA-2x11P | 25.40 | 27.94 | A2541WVA-2x31P | 76.20 | 78.74 |
| A2541WVA-2x12P | 27.94 | 30.48 | A2541WVA-2x32P | 78.74 | 81.28 |
| A2541WVA-2x13P | 30.48 | 33.02 | A2541WVA-2x33P | 81.28 | 83.82 |
| A2541WVA-2x14P | 33.02 | 35.56 | A2541WVA-2x34P | 83.82 | 86.36 |
| A2541WVA-2x15P | 35.56 | 38.10 | A2541WVA-2x35P | 86.36 | 88.90 |
| A2541WVA-2x16P | 38.10 | 40.64 | A2541WVA-2x36P | 88.90 | 91.44 |
| A2541WVA-2x17P | 40.64 | 43.18 | A2541WVA-2x37P | 91.44 | 93.98 |
| A2541WVA-2x18P | 43.18 | 45.72 | A2541WVA-2x38P | 93.98 | 96.52 |
| A2541WVA-2x19P | 45.72 | 48.26 | A2541WVA-2x39P | 96.52 | 99.06 |
| A2541WVA-2x20P | 48.26 | 50.80 | A2541WVA-2x40P | 99.06 | 101.60 |
| A2541WVA-2x21P | 50.80 | 53.34 | | | |

Unit: mm

A2541WVA-S-2

2.54mm Pitch 180° Dual Row Pin Header-SMT TYPE

Reference Informations:

- *Material: Pin: Brass/Gold over Nickel
Insulator: Nylon 6T, UL94V-0
- *Mates with CJT A2541 series dual row Housing
Optional Gold plating available but MOQ requested
- *Color: Black

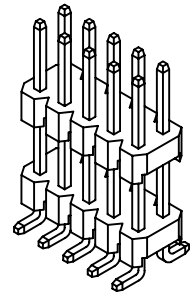
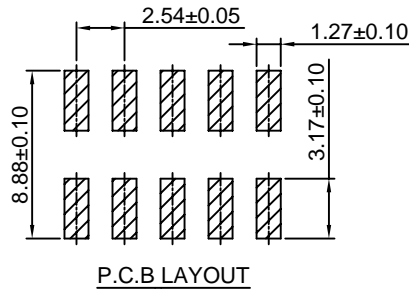
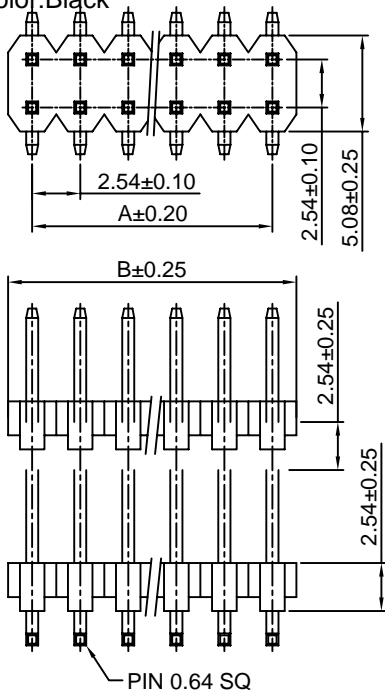

Ordering Information & Dimensions:

| PART NO. | Dimensions | | PART NO. | Dimensions | |
|------------------|------------|-------|------------------|------------|--------|
| | A | B | | A | B |
| A2541WVA-S-2x2P | 2.54 | 5.08 | A2541WVA-S-2x22P | 53.34 | 55.88 |
| A2541WVA-S-2x3P | 5.08 | 7.62 | A2541WVA-S-2x23P | 55.88 | 58.42 |
| A2541WVA-S-2x4P | 7.62 | 10.16 | A2541WVA-S-2x24P | 58.42 | 60.96 |
| A2541WVA-S-2x5P | 10.16 | 12.70 | A2541WVA-S-2x25P | 60.96 | 63.50 |
| A2541WVA-S-2x6P | 12.70 | 15.24 | A2541WVA-S-2x26P | 63.50 | 66.04 |
| A2541WVA-S-2x7P | 15.24 | 17.78 | A2541WVA-S-2x27P | 66.04 | 68.58 |
| A2541WVA-S-2x8P | 17.78 | 20.32 | A2541WVA-S-2x28P | 68.58 | 71.12 |
| A2541WVA-S-2x9P | 20.32 | 22.86 | A2541WVA-S-2x29P | 71.12 | 73.66 |
| A2541WVA-S-2x10P | 22.86 | 25.40 | A2541WVA-S-2x30P | 73.66 | 76.20 |
| A2541WVA-S-2x11P | 25.40 | 27.94 | A2541WVA-S-2x31P | 76.20 | 78.74 |
| A2541WVA-S-2x12P | 27.94 | 30.48 | A2541WVA-S-2x32P | 78.74 | 81.28 |
| A2541WVA-S-2x13P | 30.48 | 33.02 | A2541WVA-S-2x33P | 81.28 | 83.82 |
| A2541WVA-S-2x14P | 33.02 | 35.56 | A2541WVA-S-2x34P | 83.82 | 86.36 |
| A2541WVA-S-2x15P | 35.56 | 38.10 | A2541WVA-S-2x35P | 86.36 | 88.90 |
| A2541WVA-S-2x16P | 38.10 | 40.64 | A2541WVA-S-2x36P | 88.90 | 91.44 |
| A2541WVA-S-2x17P | 40.64 | 43.18 | A2541WVA-S-2x37P | 91.44 | 93.98 |
| A2541WVA-S-2x18P | 43.18 | 45.72 | A2541WVA-S-2x38P | 93.98 | 96.52 |
| A2541WVA-S-2x19P | 45.72 | 48.26 | A2541WVA-S-2x39P | 96.52 | 99.06 |
| A2541WVA-S-2x20P | 48.26 | 50.80 | A2541WVA-S-2x40P | 99.06 | 101.60 |
| A2541WVA-S-2x21P | 50.80 | 53.34 | | | |

Unit: mm

A2541WR-2

2.54mm Pitch 90° Dual Row Pin Header

Reference Informations:

- *Material: Pin: Brass/Gold over Nickel
Insulator: PBT30%GF, UL94V-0
- *Mates with CJT A2541 series dual row Housing
Optional Gold plating available but MOQ requested
- *Color: Black

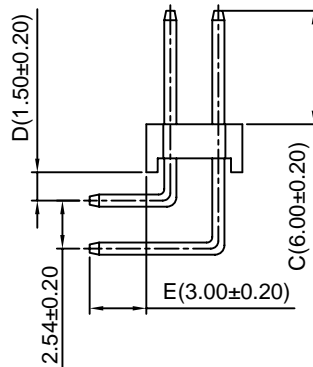
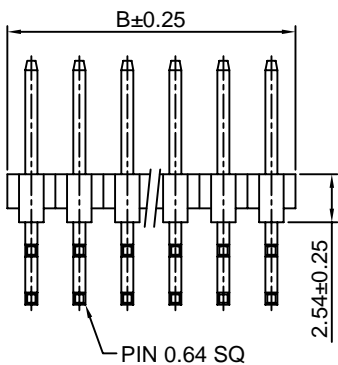
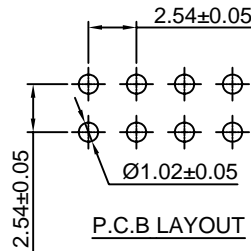
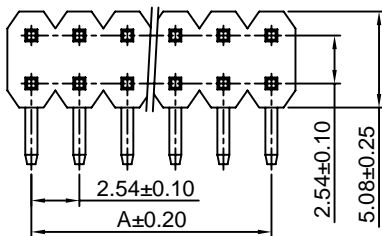
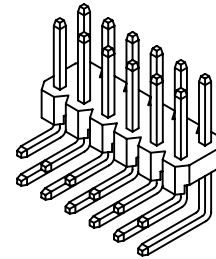

Ordering Information & Dimensions:

| PART NO. | Dimensions | | PART NO. | Dimensions | |
|---------------|------------|-------|---------------|------------|--------|
| | A | B | | A | B |
| A2541WR-2x2P | 2.54 | 5.08 | A2541WR-2x22P | 53.34 | 55.88 |
| A2541WR-2x3P | 5.08 | 7.62 | A2541WR-2x23P | 55.88 | 58.42 |
| A2541WR-2x4P | 7.62 | 10.16 | A2541WR-2x24P | 58.42 | 60.96 |
| A2541WR-2x5P | 10.16 | 12.70 | A2541WR-2x25P | 60.96 | 63.50 |
| A2541WR-2x6P | 12.70 | 15.24 | A2541WR-2x26P | 63.50 | 66.04 |
| A2541WR-2x7P | 15.24 | 17.78 | A2541WR-2x27P | 66.04 | 68.58 |
| A2541WR-2x8P | 17.78 | 20.32 | A2541WR-2x28P | 68.58 | 71.12 |
| A2541WR-2x9P | 20.32 | 22.86 | A2541WR-2x29P | 71.12 | 73.66 |
| A2541WR-2x10P | 22.86 | 25.40 | A2541WR-2x30P | 73.66 | 76.20 |
| A2541WR-2x11P | 25.40 | 27.94 | A2541WR-2x31P | 76.20 | 78.74 |
| A2541WR-2x12P | 27.94 | 30.48 | A2541WR-2x32P | 78.74 | 81.28 |
| A2541WR-2x13P | 30.48 | 33.02 | A2541WR-2x33P | 81.28 | 83.82 |
| A2541WR-2x14P | 33.02 | 35.56 | A2541WR-2x34P | 83.82 | 86.36 |
| A2541WR-2x15P | 35.56 | 38.10 | A2541WR-2x35P | 86.36 | 88.90 |
| A2541WR-2x16P | 38.10 | 40.64 | A2541WR-2x36P | 88.90 | 91.44 |
| A2541WR-2x17P | 40.64 | 43.18 | A2541WR-2x37P | 91.44 | 93.98 |
| A2541WR-2x18P | 43.18 | 45.72 | A2541WR-2x38P | 93.98 | 96.52 |
| A2541WR-2x19P | 45.72 | 48.26 | A2541WR-2x39P | 96.52 | 99.06 |
| A2541WR-2x20P | 48.26 | 50.80 | A2541WR-2x40P | 99.06 | 101.60 |
| A2541WR-2x21P | 50.80 | 53.34 | | | |

Unit: mm

A2541WRA-2

2.54mm Pitch 90° Dual Row Pin Header

Reference Informations:

- *Material: Pin: Brass/Gold over Nickel
Insulator: PBT30%GF, UL94V-0
- *Mates with CJT A2541 series dual row Housing
Optional Gold plating available but MOQ requested
- *Color: Black

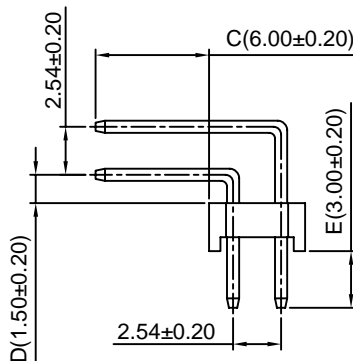
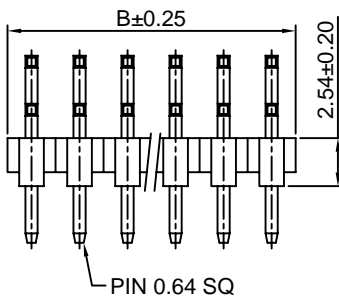
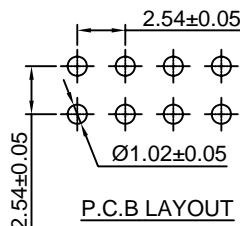
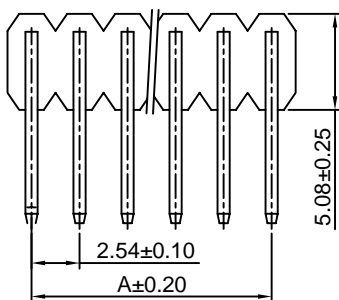
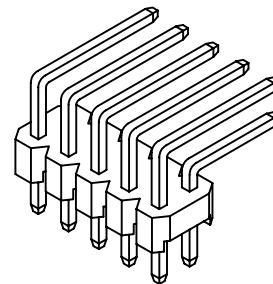

Ordering Information & Dimensions:

| PART NO. | Dimensions | | PART NO. | Dimensions | |
|----------------|------------|-------|----------------|------------|--------|
| | A | B | | A | B |
| A2541WRA-2x2P | 2.54 | 5.08 | A2541WRA-2x22P | 53.34 | 55.88 |
| A2541WRA-2x3P | 5.08 | 7.62 | A2541WRA-2x23P | 55.88 | 58.42 |
| A2541WRA-2x4P | 7.62 | 10.16 | A2541WRA-2x24P | 58.42 | 60.96 |
| A2541WRA-2x5P | 10.16 | 12.70 | A2541WRA-2x25P | 60.96 | 63.50 |
| A2541WRA-2x6P | 12.70 | 15.24 | A2541WRA-2x26P | 63.50 | 66.04 |
| A2541WRA-2x7P | 15.24 | 17.78 | A2541WRA-2x27P | 66.04 | 68.58 |
| A2541WRA-2x8P | 17.78 | 20.32 | A2541WRA-2x28P | 68.58 | 71.12 |
| A2541WRA-2x9P | 20.32 | 22.86 | A2541WRA-2x29P | 71.12 | 73.66 |
| A2541WRA-2x10P | 22.86 | 25.40 | A2541WRA-2x30P | 73.66 | 76.20 |
| A2541WRA-2x11P | 25.40 | 27.94 | A2541WRA-2x31P | 76.20 | 78.74 |
| A2541WRA-2x12P | 27.94 | 30.48 | A2541WRA-2x32P | 78.74 | 81.28 |
| A2541WRA-2x13P | 30.48 | 33.02 | A2541WRA-2x33P | 81.28 | 83.82 |
| A2541WRA-2x14P | 33.02 | 35.56 | A2541WRA-2x34P | 83.82 | 86.36 |
| A2541WRA-2x15P | 35.56 | 38.10 | A2541WRA-2x35P | 86.36 | 88.90 |
| A2541WRA-2x16P | 38.10 | 40.64 | A2541WRA-2x36P | 88.90 | 91.44 |
| A2541WRA-2x17P | 40.64 | 43.18 | A2541WRA-2x37P | 91.44 | 93.98 |
| A2541WRA-2x18P | 43.18 | 45.72 | A2541WRA-2x38P | 93.98 | 96.52 |
| A2541WRA-2x19P | 45.72 | 48.26 | A2541WRA-2x39P | 96.52 | 99.06 |
| A2541WRA-2x20P | 48.26 | 50.80 | A2541WRA-2x40P | 99.06 | 101.60 |
| A2541WRA-2x21P | 50.80 | 53.34 | | | |

Unit: mm

A2541WV-N-2

2.54mm Pitch 180° Dual Row Box Header

Reference Informations:

- *Material: Pin: Brass/Gold over Nickel
Insulator: PBT15%GF, UL94V-0
- *Mates with CJT A2541H-N series Dual row Housing
- *Color: Black

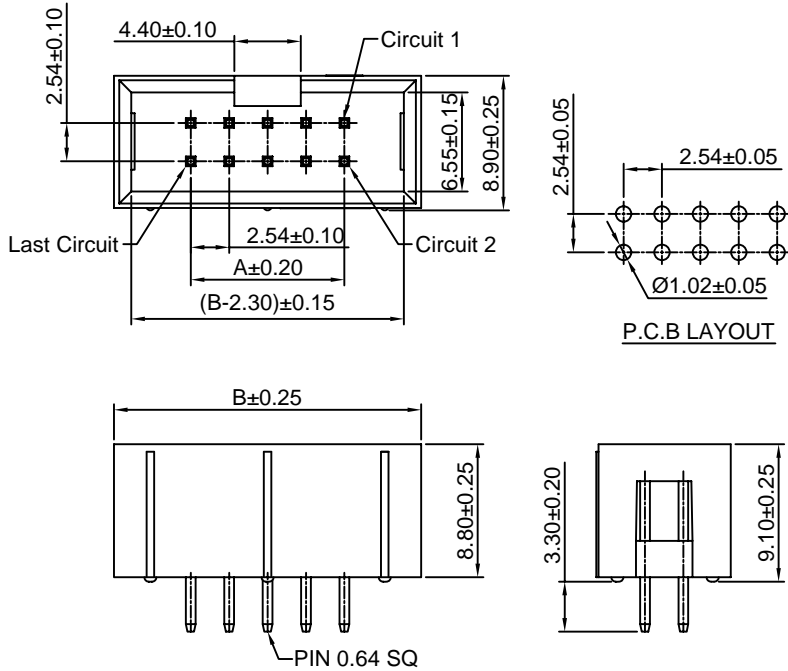
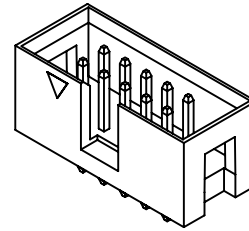

Ordering Information & Dimensions:

| PART NO. | Dimensions | | PART NO. | Dimensions | |
|-----------------|------------|-------|-----------------|------------|--------|
| | A | B | | A | B |
| A2541WV-N-2x2P | 2.54 | 12.70 | A2541WV-N-2x22P | 53.34 | 63.50 |
| A2541WV-N-2x3P | 5.08 | 15.24 | A2541WV-N-2x23P | 55.88 | 66.04 |
| A2541WV-N-2x4P | 7.62 | 17.78 | A2541WV-N-2x24P | 58.42 | 68.58 |
| A2541WV-N-2x5P | 10.16 | 20.32 | A2541WV-N-2x25P | 60.96 | 71.12 |
| A2541WV-N-2x6P | 12.70 | 22.86 | A2541WV-N-2x26P | 63.50 | 73.66 |
| A2541WV-N-2x7P | 15.24 | 25.40 | A2541WV-N-2x27P | 66.04 | 76.20 |
| A2541WV-N-2x8P | 17.78 | 27.94 | A2541WV-N-2x28P | 68.58 | 78.74 |
| A2541WV-N-2x9P | 20.32 | 30.48 | A2541WV-N-2x29P | 71.12 | 81.28 |
| A2541WV-N-2x10P | 22.86 | 33.02 | A2541WV-N-2x30P | 73.66 | 83.82 |
| A2541WV-N-2x11P | 25.40 | 35.56 | A2541WV-N-2x31P | 76.20 | 86.36 |
| A2541WV-N-2x12P | 27.94 | 38.10 | A2541WV-N-2x32P | 78.74 | 88.90 |
| A2541WV-N-2x13P | 30.48 | 40.64 | A2541WV-N-2x33P | 81.28 | 91.44 |
| A2541WV-N-2x14P | 33.02 | 43.18 | A2541WV-N-2x34P | 83.82 | 93.98 |
| A2541WV-N-2x15P | 35.56 | 45.72 | A2541WV-N-2x35P | 86.36 | 96.52 |
| A2541WV-N-2x16P | 38.10 | 48.26 | A2541WV-N-2x36P | 88.90 | 99.06 |
| A2541WV-N-2x17P | 40.64 | 50.80 | A2541WV-N-2x37P | 91.44 | 101.60 |
| A2541WV-N-2x18P | 43.18 | 53.34 | A2541WV-N-2x38P | 93.98 | 104.14 |
| A2541WV-N-2x19P | 45.72 | 55.88 | A2541WV-N-2x39P | 96.52 | 106.68 |
| A2541WV-N-2x20P | 48.26 | 58.42 | A2541WV-N-2x40P | 99.06 | 109.22 |
| A2541WV-N-2x21P | 50.80 | 60.96 | | | |

Unit: mm

A2541WR-N-2

2.54mm Pitch 90° Dual Row Box Header

Reference Informations:

- *Material: Pin: Brass/Gold over Nickel
Insulator: PBT15%GF, UL94V-0
- *Mates with CJT A2541H-N series Dual row Housing
- *Color: Black

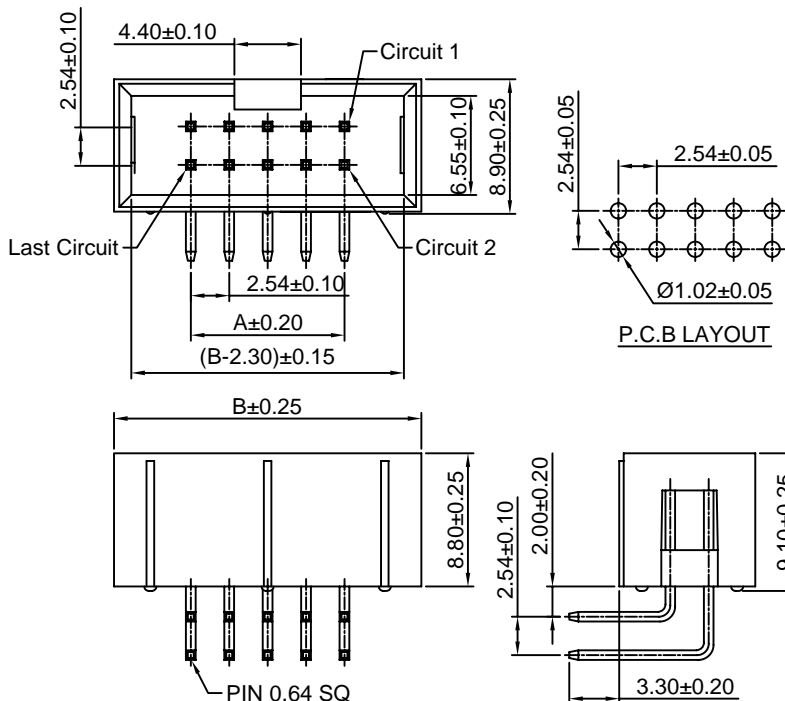
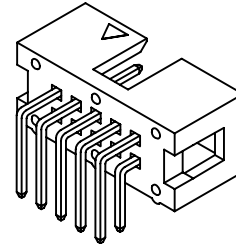

Ordering Information & Dimensions:

| PART NO. | Dimensions | | PART NO. | Dimensions | |
|-----------------|------------|-------|-----------------|------------|--------|
| | A | B | | A | B |
| A2541WR-N-2x2P | 2.54 | 12.70 | A2541WR-N-2x22P | 53.34 | 63.50 |
| A2541WR-N-2x3P | 5.08 | 15.24 | A2541WR-N-2x23P | 55.88 | 66.04 |
| A2541WR-N-2x4P | 7.62 | 17.78 | A2541WR-N-2x24P | 58.42 | 68.58 |
| A2541WR-N-2x5P | 10.16 | 20.32 | A2541WR-N-2x25P | 60.96 | 71.12 |
| A2541WR-N-2x6P | 12.70 | 22.86 | A2541WR-N-2x26P | 63.50 | 73.66 |
| A2541WR-N-2x7P | 15.24 | 25.40 | A2541WR-N-2x27P | 66.04 | 76.20 |
| A2541WR-N-2x8P | 17.78 | 27.94 | A2541WR-N-2x28P | 68.58 | 78.74 |
| A2541WR-N-2x9P | 20.32 | 30.48 | A2541WR-N-2x29P | 71.12 | 81.28 |
| A2541WR-N-2x10P | 22.86 | 33.02 | A2541WR-N-2x30P | 73.66 | 83.82 |
| A2541WR-N-2x11P | 25.40 | 35.56 | A2541WR-N-2x31P | 76.20 | 86.36 |
| A2541WR-N-2x12P | 27.94 | 38.10 | A2541WR-N-2x32P | 78.74 | 88.90 |
| A2541WR-N-2x13P | 30.48 | 40.64 | A2541WR-N-2x33P | 81.28 | 91.44 |
| A2541WR-N-2x14P | 33.02 | 43.18 | A2541WR-N-2x34P | 83.82 | 93.98 |
| A2541WR-N-2x15P | 35.56 | 45.72 | A2541WR-N-2x35P | 86.36 | 96.52 |
| A2541WR-N-2x16P | 38.10 | 48.26 | A2541WR-N-2x36P | 88.90 | 99.06 |
| A2541WR-N-2x17P | 40.64 | 50.80 | A2541WR-N-2x37P | 91.44 | 101.60 |
| A2541WR-N-2x18P | 43.18 | 53.34 | A2541WR-N-2x38P | 93.98 | 104.14 |
| A2541WR-N-2x19P | 45.72 | 55.88 | A2541WR-N-2x39P | 96.52 | 106.68 |
| A2541WR-N-2x20P | 48.26 | 58.42 | A2541WR-N-2x40P | 99.06 | 109.22 |
| A2541WR-N-2x21P | 50.80 | 60.96 | | | |

Unit: mm

A2541HVV

2.54mm Pitch 180° Single Row Box Header

Reference Informations:

- *Material:Pin:Brass/Gold over Nickel
Insulator:PBT15%GF,UL94V-0
- *Mates with CJT A2541 series Single row Pin Header
- *Color:Black

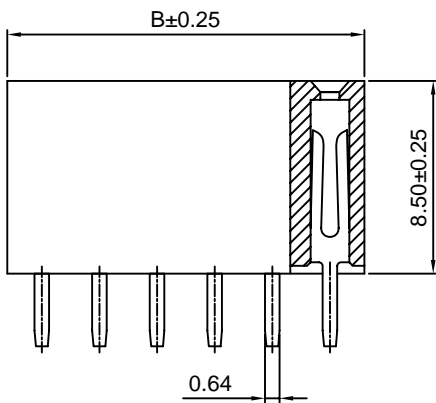
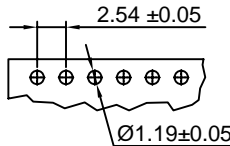
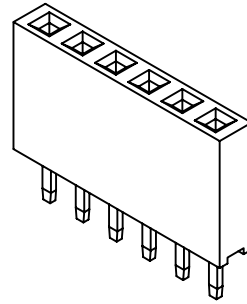

P.C.B LAYOUT

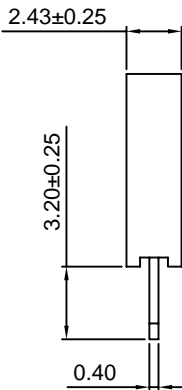

Ordering Information & Dimensions:

| PART NO. | Dimensions | | PART NO. | Dimensions | |
|--------------|------------|-------|--------------|------------|--------|
| | A | B | | A | B |
| A2541HVV-2P | 2.54 | 5.58 | A2541HVV-22P | 53.34 | 56.38 |
| A2541HVV-3P | 5.08 | 8.12 | A2541HVV-23P | 55.88 | 58.92 |
| A2541HVV-4P | 7.62 | 10.66 | A2541HVV-24P | 58.42 | 61.46 |
| A2541HVV-5P | 10.16 | 13.20 | A2541HVV-25P | 60.96 | 64.00 |
| A2541HVV-6P | 12.70 | 15.74 | A2541HVV-26P | 63.50 | 66.54 |
| A2541HVV-7P | 15.24 | 18.28 | A2541HVV-27P | 66.04 | 69.08 |
| A2541HVV-8P | 17.78 | 20.82 | A2541HVV-28P | 68.58 | 71.62 |
| A2541HVV-9P | 20.32 | 23.36 | A2541HVV-29P | 71.12 | 74.16 |
| A2541HVV-10P | 22.86 | 25.90 | A2541HVV-30P | 73.66 | 76.70 |
| A2541HVV-11P | 25.40 | 28.44 | A2541HVV-31P | 76.20 | 79.24 |
| A2541HVV-12P | 27.94 | 30.98 | A2541HVV-32P | 78.74 | 81.78 |
| A2541HVV-13P | 30.48 | 33.52 | A2541HVV-33P | 81.28 | 84.32 |
| A2541HVV-14P | 33.02 | 36.06 | A2541HVV-34P | 83.82 | 86.86 |
| A2541HVV-15P | 35.56 | 38.60 | A2541HVV-35P | 86.36 | 89.40 |
| A2541HVV-16P | 38.10 | 41.14 | A2541HVV-36P | 88.90 | 91.94 |
| A2541HVV-17P | 40.64 | 43.68 | A2541HVV-37P | 91.44 | 94.48 |
| A2541HVV-18P | 43.18 | 46.22 | A2541HVV-38P | 93.98 | 97.02 |
| A2541HVV-19P | 45.72 | 48.76 | A2541HVV-39P | 96.52 | 99.56 |
| A2541HVV-20P | 48.26 | 51.30 | A2541HVV-40P | 99.06 | 102.20 |
| A2541HVV-21P | 50.80 | 53.84 | | | |

Unit: mm

A2541HWR

2.54mm Pitch 90° Single Row Box Header

Reference Informations:

- *Material:Pin:Brass/Gold over Nickel
Insulator:PBT15%GF,UL94V-0
- *Mates with CJT A2541 series Single row Pin Header
- *Color:Black

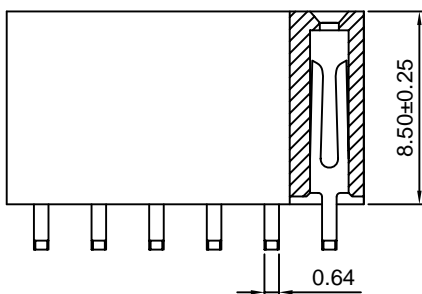
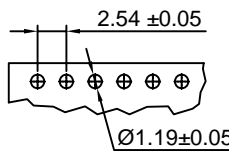
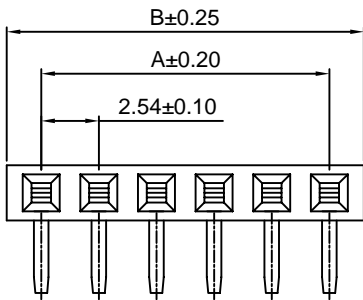
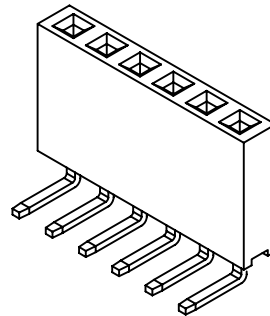

P.C.B LAYOUT

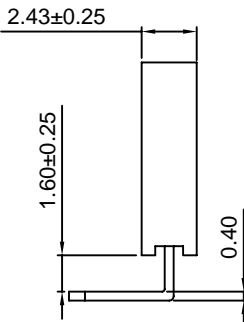

Ordering Information & Dimensions:

| PART NO. | Dimensions | | PART NO. | Dimensions | |
|--------------|------------|-------|--------------|------------|--------|
| | A | B | | A | B |
| A2541HWR-2P | 2.54 | 5.58 | A2541HWR-22P | 53.34 | 56.38 |
| A2541HWR-3P | 5.08 | 8.12 | A2541HWR-23P | 55.88 | 58.92 |
| A2541HWR-4P | 7.62 | 10.66 | A2541HWR-24P | 58.42 | 61.46 |
| A2541HWR-5P | 10.16 | 13.20 | A2541HWR-25P | 60.96 | 64.00 |
| A2541HWR-6P | 12.70 | 15.74 | A2541HWR-26P | 63.50 | 66.54 |
| A2541HWR-7P | 15.24 | 18.28 | A2541HWR-27P | 66.04 | 69.08 |
| A2541HWR-8P | 17.78 | 20.82 | A2541HWR-28P | 68.58 | 71.62 |
| A2541HWR-9P | 20.32 | 23.36 | A2541HWR-29P | 71.12 | 74.16 |
| A2541HWR-10P | 22.86 | 25.90 | A2541HWR-30P | 73.66 | 76.70 |
| A2541HWR-11P | 25.40 | 28.44 | A2541HWR-31P | 76.20 | 79.24 |
| A2541HWR-12P | 27.94 | 30.98 | A2541HWR-32P | 78.74 | 81.78 |
| A2541HWR-13P | 30.48 | 33.52 | A2541HWR-33P | 81.28 | 84.32 |
| A2541HWR-14P | 33.02 | 36.06 | A2541HWR-34P | 83.82 | 86.86 |
| A2541HWR-15P | 35.56 | 38.60 | A2541HWR-35P | 86.36 | 89.40 |
| A2541HWR-16P | 38.10 | 41.14 | A2541HWR-36P | 88.90 | 91.94 |
| A2541HWR-17P | 40.64 | 43.68 | A2541HWR-37P | 91.44 | 94.48 |
| A2541HWR-18P | 43.18 | 46.22 | A2541HWR-38P | 93.98 | 97.02 |
| A2541HWR-19P | 45.72 | 48.76 | A2541HWR-39P | 96.52 | 99.56 |
| A2541HWR-20P | 48.26 | 51.30 | A2541HWR-40P | 99.06 | 102.20 |
| A2541HWR-21P | 50.80 | 53.84 | | | |

Unit: mm

A2541HWV-2

2.54mm Pitch 180° Dual Row Box Header

Reference Informations:

- *Material: Pin: Brass/Gold over Nickel
Insulator: PBT15%GF, UL94V-0
- *Mates with CJT A2541 series Dual row Pin Header
- *Color: Black

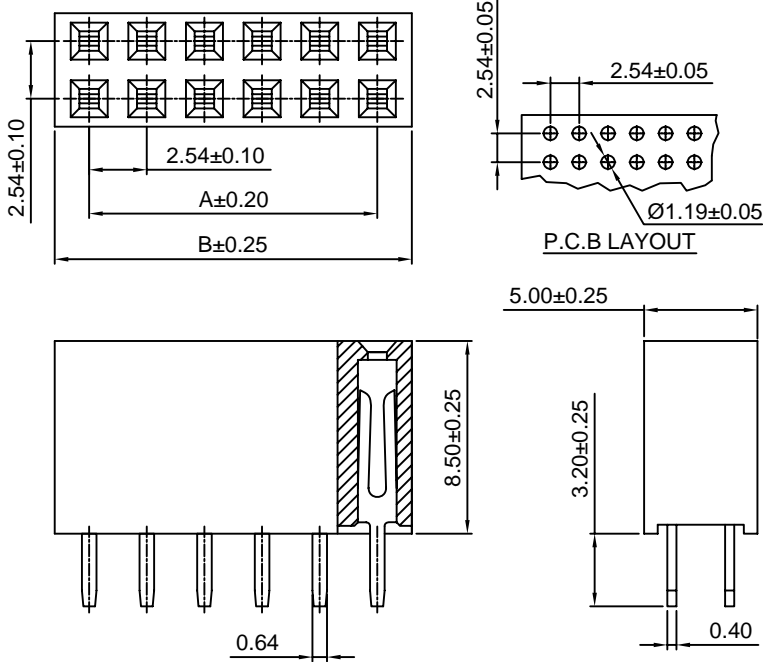
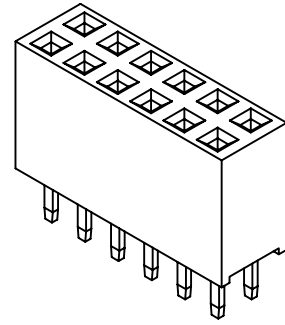

Ordering Information & Dimensions:

| PART NO. | Dimensions | | PART NO. | Dimensions | |
|----------------|------------|-------|----------------|------------|--------|
| | A | B | | A | B |
| A2541HWV-2x2P | 2.54 | 5.58 | A2541HWV-2x22P | 53.34 | 56.38 |
| A2541HWV-2x3P | 5.08 | 8.12 | A2541HWV-2x23P | 55.88 | 58.92 |
| A2541HWV-2x4P | 7.62 | 10.66 | A2541HWV-2x24P | 58.42 | 61.46 |
| A2541HWV-2x5P | 10.16 | 13.20 | A2541HWV-2x25P | 60.96 | 64.00 |
| A2541HWV-2x6P | 12.70 | 15.74 | A2541HWV-2x26P | 63.50 | 66.54 |
| A2541HWV-2x7P | 15.24 | 18.28 | A2541HWV-2x27P | 66.04 | 69.08 |
| A2541HWV-2x8P | 17.78 | 20.82 | A2541HWV-2x28P | 68.58 | 71.62 |
| A2541HWV-2x9P | 20.32 | 23.36 | A2541HWV-2x29P | 71.12 | 74.16 |
| A2541HWV-2x10P | 22.86 | 25.90 | A2541HWV-2x30P | 73.66 | 76.70 |
| A2541HWV-2x11P | 25.40 | 28.44 | A2541HWV-2x31P | 76.20 | 79.24 |
| A2541HWV-2x12P | 27.94 | 30.98 | A2541HWV-2x32P | 78.74 | 81.78 |
| A2541HWV-2x13P | 30.48 | 33.52 | A2541HWV-2x33P | 81.28 | 84.32 |
| A2541HWV-2x14P | 33.02 | 36.06 | A2541HWV-2x34P | 83.82 | 86.86 |
| A2541HWV-2x15P | 35.56 | 38.60 | A2541HWV-2x35P | 86.36 | 89.40 |
| A2541HWV-2x16P | 38.10 | 41.14 | A2541HWV-2x36P | 88.90 | 91.94 |
| A2541HWV-2x17P | 40.64 | 43.68 | A2541HWV-2x37P | 91.44 | 94.48 |
| A2541HWV-2x18P | 43.18 | 46.22 | A2541HWV-2x38P | 93.98 | 97.02 |
| A2541HWV-2x19P | 45.72 | 48.76 | A2541HWV-2x39P | 96.52 | 99.56 |
| A2541HWV-2x20P | 48.26 | 51.30 | A2541HWV-2x40P | 99.06 | 102.20 |
| A2541HWV-2x21P | 50.80 | 53.84 | | | |

Unit: mm

A2541HWR-2

2.54mm Pitch 90° Dual Row Box Header

Reference Informations:

- *Material: Pin: Brass/Gold over Nickel
Insulator: PBT15%GF, UL94V-0
- *Mates with CJT A2541 series Dual row Pin Header
- *Color: Black

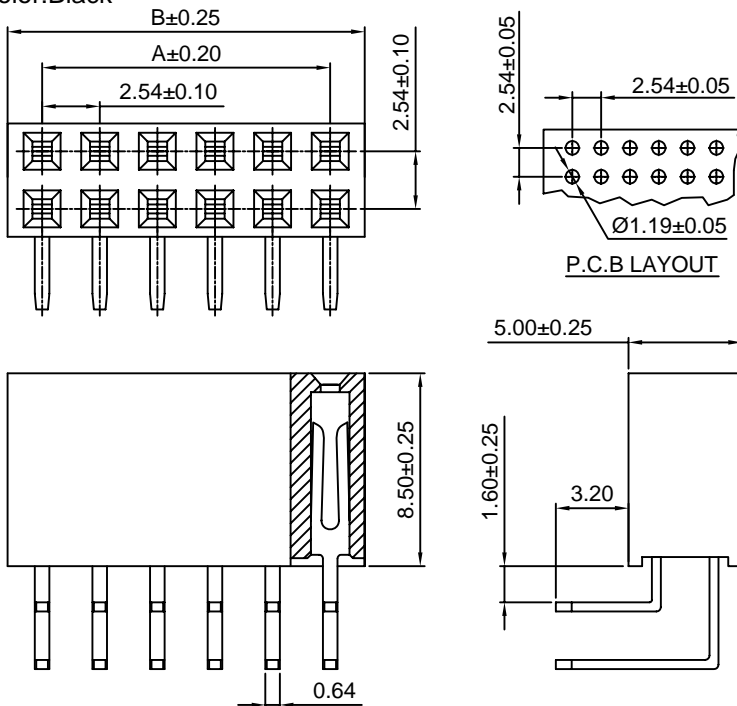
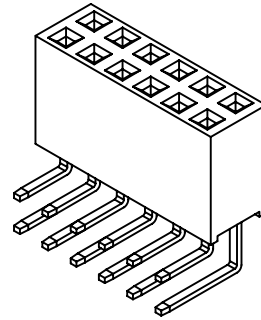

Ordering Information & Dimensions:

| PART NO. | Dimensions | | PART NO. | Dimensions | |
|----------------|------------|-------|----------------|------------|--------|
| | A | B | | A | B |
| A2541HWR-2x2P | 2.54 | 5.58 | A2541HWR-2x22P | 53.34 | 56.38 |
| A2541HWR-2x3P | 5.08 | 8.12 | A2541HWR-2x23P | 55.88 | 58.92 |
| A2541HWR-2x4P | 7.62 | 10.66 | A2541HWR-2x24P | 58.42 | 61.46 |
| A2541HWR-2x5P | 10.16 | 13.20 | A2541HWR-2x25P | 60.96 | 64.00 |
| A2541HWR-2x6P | 12.70 | 15.74 | A2541HWR-2x26P | 63.50 | 66.54 |
| A2541HWR-2x7P | 15.24 | 18.28 | A2541HWR-2x27P | 66.04 | 69.08 |
| A2541HWR-2x8P | 17.78 | 20.82 | A2541HWR-2x28P | 68.58 | 71.62 |
| A2541HWR-2x9P | 20.32 | 23.36 | A2541HWR-2x29P | 71.12 | 74.16 |
| A2541HWR-2x10P | 22.86 | 25.90 | A2541HWR-2x30P | 73.66 | 76.70 |
| A2541HWR-2x11P | 25.40 | 28.44 | A2541HWR-2x31P | 76.20 | 79.24 |
| A2541HWR-2x12P | 27.94 | 30.98 | A2541HWR-2x32P | 78.74 | 81.78 |
| A2541HWR-2x13P | 30.48 | 33.52 | A2541HWR-2x33P | 81.28 | 84.32 |
| A2541HWR-2x14P | 33.02 | 36.06 | A2541HWR-2x34P | 83.82 | 86.86 |
| A2541HWR-2x15P | 35.56 | 38.60 | A2541HWR-2x35P | 86.36 | 89.40 |
| A2541HWR-2x16P | 38.10 | 41.14 | A2541HWR-2x36P | 88.90 | 91.94 |
| A2541HWR-2x17P | 40.64 | 43.68 | A2541HWR-2x37P | 91.44 | 94.48 |
| A2541HWR-2x18P | 43.18 | 46.22 | A2541HWR-2x38P | 93.98 | 97.02 |
| A2541HWR-2x19P | 45.72 | 48.76 | A2541HWR-2x39P | 96.52 | 99.56 |
| A2541HWR-2x20P | 48.26 | 51.30 | A2541HWR-2x40P | 99.06 | 102.20 |
| A2541HWR-2x21P | 50.80 | 53.84 | | | |

Unit: mm

X-ON Electronics

Largest Supplier of Electrical and Electronic Components

Click to view similar products for [Headers & Wire Housings](#) category:

Click to view products by [Changjiang](#) manufacturer:

Other Similar products are found below :

[57102-F02-18ULF](#) [58102-G61-06LF](#) [0009485154](#) [009176003701906](#) [0050291907](#) [00-9021-0611-00-339](#) [02.125.8002.8](#) [609-3404](#) [61062-3](#)
[622-0430](#) [622-3653LF](#) [63453-116](#) [636-1030](#) [636-1427](#) [636-3427](#) [636-4007](#) [641938-9](#) [644827-2](#) [65495-038](#) [65692-001LF](#) [65781-018](#)
[65781-047](#) [65817-010LF](#) [65817-015LF](#) [66207-023LF](#) [67016-026LF](#) [67095-007LF](#) [68631-112](#) [68645-018](#) [68648-049](#) [699319-000](#)
[70.362.1628.0](#) [70-4210](#) [70-4226B](#) [70-4853B](#) [707-5020](#) [707-5028](#) [71.350.2428.0](#) [71961-016LF](#) [733-134](#) [754199-000](#) [760-3052](#) [787-8014-00](#)
[FCN-367T-T012/H](#) [80.063.4001.1](#) [800-90-001-10-001000](#) [800-90-010-10-002000](#) [801-43-002-10-013000](#) [801-43-006-10-002000](#)
[803-41-018-10-001000](#)