

Specifications

- Current rating: 7A AC, DC
- Voltage rating: 250V AC, DC
- Temperature range: -40°C ~ +105°C
- Contact resistance: 10mΩ Max.
- Insulation resistance: 1000MΩ Min.
- Withstanding voltage: 1500V AC/minute
- *Compliant with RoHS and REACH*
- *Meet the HF/Halogen Free, GWT/Glow wire Test (IEC60335-1) request, need to customize*
- *Contact CJT for details*

Standards



Assembly layout

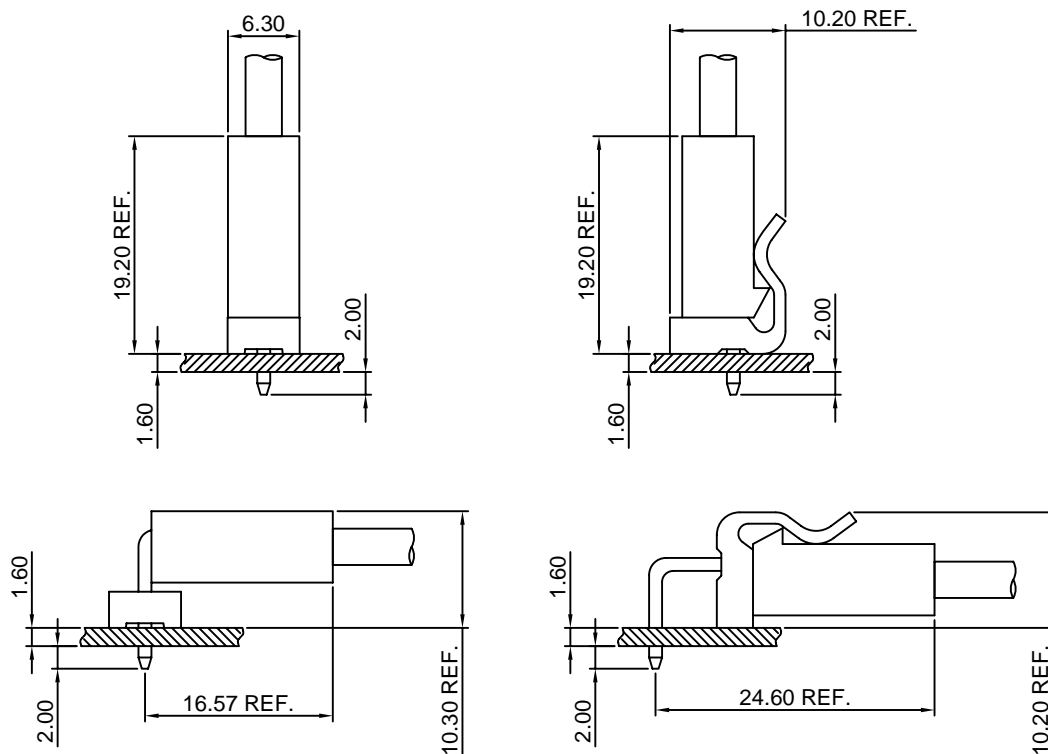

A3961-T

3.96mm pitch Crimp Terminal

Reference Informations:

*Used in CJT A3961 series Housing

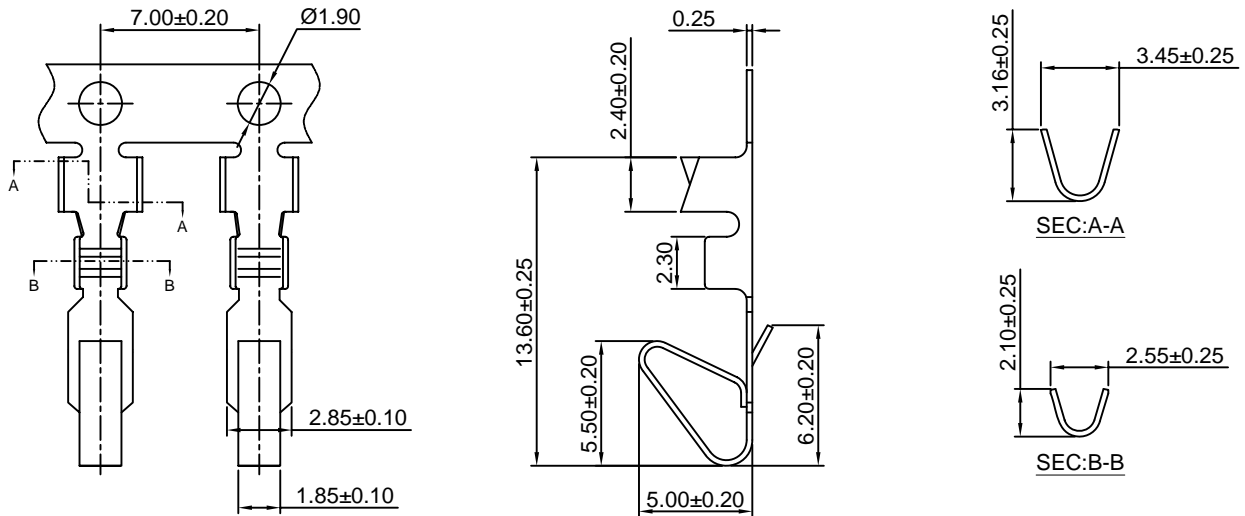

Ordering information & Specifications:

Unit:mm

| Part NO. | Wire Range | Insulation O.D. | Material | Finish | Qty/reel |
|----------|------------|-----------------|-----------------|------------------|-----------|
| A3961-TB | AWG#18-#24 | 2.80mm(max) | Brass | Tin over Nickel | 6,000 PCS |
| A3961-TP | AWG#18-#24 | 2.80mm(max) | Phosphor Bronze | Tin over Nickel | 6,000 PCS |
| A3961-GB | AWG#18-#24 | 2.80mm(max) | Brass | Gold over Nickel | 6,000 PCS |
| A3961-GP | AWG#18-#24 | 2.80mm(max) | Phosphor Bronze | Gold over Nickel | 6,000 PCS |

Optional Gold plating available but MOQ requested

A3961-T-1

3.96mm pitch Crimp Terminal

Reference Informations:

*Used in CJT A3961 series Housing

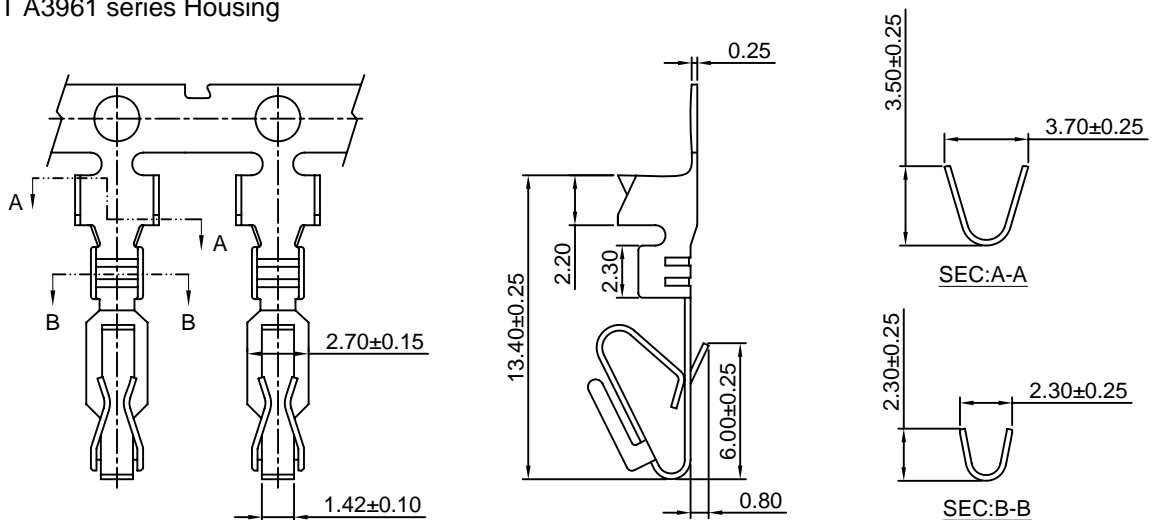

Ordering information & Specifications:

Unit:mm

| Part NO. | Wire Range | Insulation O.D. | Material | Finish | Qty/reel |
|------------|------------|-----------------|-----------------|------------------|-----------|
| A3961-TB-1 | AWG#18-#24 | 2.80mm(max) | Brass | Tin over Nickel | 6,000 PCS |
| A3961-TP-1 | AWG#18-#24 | 2.80mm(max) | Phosphor Bronze | Tin over Nickel | 6,000 PCS |
| A3961-GB-1 | AWG#18-#24 | 2.80mm(max) | Brass | Gold over Nickel | 6,000 PCS |
| A3961-GP-1 | AWG#18-#24 | 2.80mm(max) | Phosphor Bronze | Gold over Nickel | 6,000 PCS |

Optional Gold plating available but MOQ requested

A3961H

3.96mm pitch Housing

Reference Informations:

- *Material:Nylon 66,UL94V-2
- *Suitable CJT A3961 series Terminal
- *Mates with CJT A3961 series Wafer
- *Color:Natural

Ordering Information:

- A3961H-XP - *
 $\frac{1}{2}$
 1.Part No.
 2.Material:
 (blank)-UL94V-2
 V0-UL94V-0

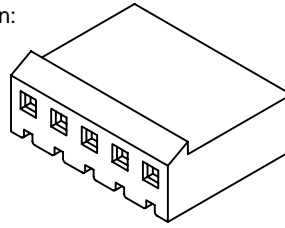

Ordering Information & Dimensions:

| PART NO. | Dimensions | |
|------------|------------|-------|
| | A | B |
| A3961H-2P | 3.96 | 8.43 |
| A3961H-3P | 7.92 | 12.39 |
| A3961H-4P | 11.88 | 16.35 |
| A3961H-5P | 15.84 | 20.31 |
| A3961H-6P | 19.80 | 24.27 |
| A3961H-7P | 23.76 | 28.23 |
| A3961H-8P | 27.72 | 32.19 |
| A3961H-9P | 31.68 | 36.15 |
| A3961H-10P | 35.64 | 40.11 |
| A3961H-11P | 39.60 | 44.07 |
| A3961H-12P | 43.56 | 48.03 |
| A3961H-13P | 47.52 | 51.99 |
| A3961H-14P | 51.48 | 55.95 |
| A3961H-15P | 55.44 | 59.91 |
| A3961H-16P | 59.40 | 63.87 |
| A3961H-17P | 63.36 | 67.83 |
| A3961H-18P | 67.32 | 71.79 |
| A3961H-19P | 71.28 | 75.75 |
| A3961H-20P | 75.24 | 79.71 |
| A3961H-21P | 79.20 | 83.67 |
| A3961H-22P | 83.16 | 87.63 |
| A3961H-23P | 87.12 | 91.59 |
| A3961H-24P | 91.08 | 95.55 |

Unit: mm

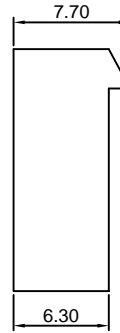
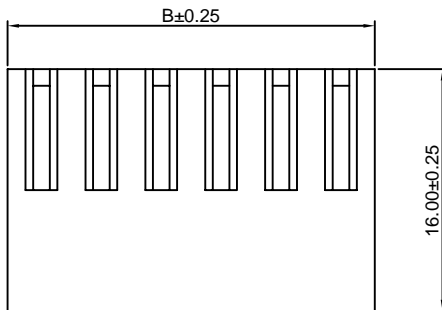
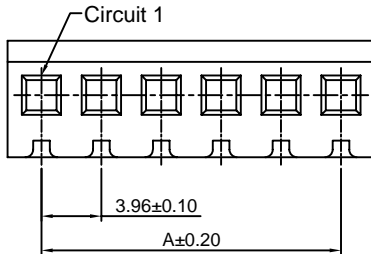

A3961H-2

3.96mm pitch Housing

Reference Informations:

- *Material:Nylon 66,UL94V-2
- *Suitable CJT A3961 series Terminal
- *Mates with CJT A3961 series Wafer
- *Color:Natural

Ordering Information:

- A3961H-XP-2 - *
 $\frac{1}{2}$
 1.Part No.
 2.Material:
 (blank)-UL94V-2
 V0-UL94V-0

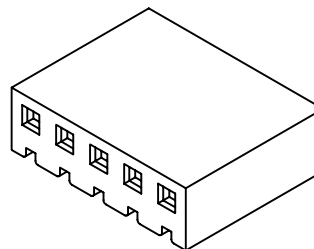

Ordering Information & Dimensions:

| PART NO. | Dimensions | |
|--------------|------------|-------|
| | A | B |
| A3961H-2P-2 | 3.96 | 8.43 |
| A3961H-3P-2 | 7.92 | 12.39 |
| A3961H-4P-2 | 11.88 | 16.35 |
| A3961H-5P-2 | 15.84 | 20.31 |
| A3961H-6P-2 | 19.80 | 24.27 |
| A3961H-7P-2 | 23.76 | 28.23 |
| A3961H-8P-2 | 27.72 | 32.19 |
| A3961H-9P-2 | 31.68 | 36.15 |
| A3961H-10P-2 | 35.64 | 40.11 |
| A3961H-11P-2 | 39.60 | 44.07 |
| A3961H-12P-2 | 43.56 | 48.03 |
| A3961H-13P-2 | 47.52 | 51.99 |
| A3961H-14P-2 | 51.48 | 55.95 |
| A3961H-15P-2 | 55.44 | 59.91 |
| A3961H-16P-2 | 59.40 | 63.87 |
| A3961H-17P-2 | 63.36 | 67.83 |
| A3961H-18P-2 | 67.32 | 71.79 |
| A3961H-19P-2 | 71.28 | 75.75 |
| A3961H-20P-2 | 75.24 | 79.71 |
| A3961H-21P-2 | 79.20 | 83.67 |
| A3961H-22P-2 | 83.16 | 87.63 |
| A3961H-23P-2 | 87.12 | 91.59 |
| A3961H-24P-2 | 91.08 | 95.55 |

Unit: mm

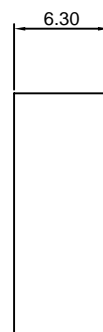
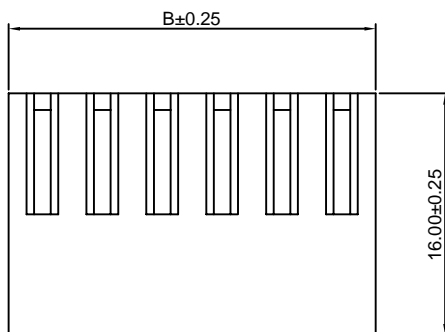
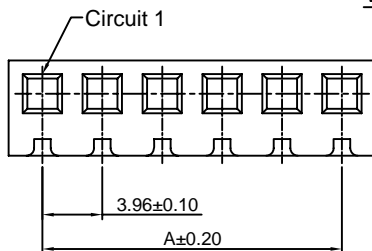

A3961H-3

3.96mm pitch Housing

Reference Informations:

- *Material:Nylon 66,UL94V-2
- *Suitable CJT A3961 series Terminal
- *Mates with CJT D3961WV D3961WR series Wafer
- *Color:Natural

Ordering Information:

- A3961H-XP-3 - $\frac{*}{2}$
1. Part No.
 2. Material:
(blank)-UL94V-2
V0-UL94V-0

Ordering Information & Dimensions:

| PART NO. | Dimensions | |
|--------------|------------|-------|
| | A | B |
| A3961H-2P-3 | 3.96 | 8.43 |
| A3961H-3P-3 | 7.92 | 12.39 |
| A3961H-4P-3 | 11.88 | 16.35 |
| A3961H-5P-3 | 15.84 | 20.31 |
| A3961H-6P-3 | 19.80 | 24.27 |
| A3961H-7P-3 | 23.76 | 28.23 |
| A3961H-8P-3 | 27.72 | 32.19 |
| A3961H-9P-3 | 31.68 | 36.15 |
| A3961H-10P-3 | 35.64 | 40.11 |
| A3961H-11P-3 | 39.60 | 44.07 |
| A3961H-12P-3 | 43.56 | 48.03 |
| A3961H-13P-3 | 47.52 | 51.99 |
| A3961H-14P-3 | 51.48 | 55.95 |
| A3961H-15P-3 | 55.44 | 59.91 |
| A3961H-16P-3 | 59.40 | 63.87 |
| A3961H-17P-3 | 63.36 | 67.83 |
| A3961H-18P-3 | 67.32 | 71.79 |
| A3961H-19P-3 | 71.28 | 75.75 |
| A3961H-20P-3 | 75.24 | 79.71 |
| A3961H-21P-3 | 79.20 | 83.67 |
| A3961H-22P-3 | 83.16 | 87.63 |
| A3961H-23P-3 | 87.12 | 91.59 |
| A3961H-24P-3 | 91.08 | 95.55 |

Unit: mm

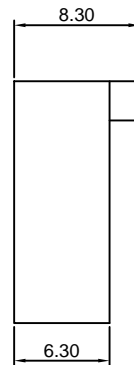
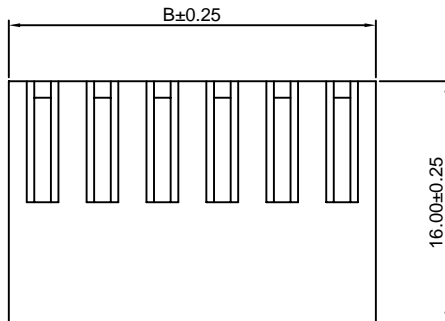
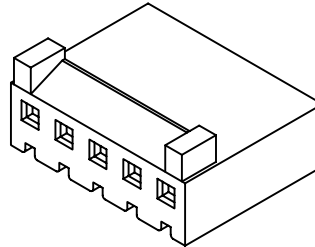
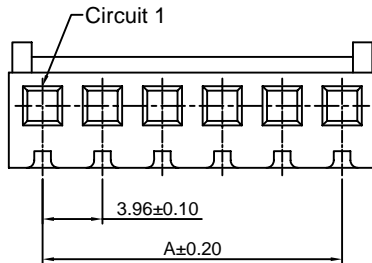

A3961WV

3.96mm pitch 180° Wafer

Reference Informations:

- *Material:Pin:Brass/Tin over Nickel
Insulator:Nylon 66,UL94V-2
- *Mates with CJT A3961 or A3964 series Housing
- *Color:Natural

Ordering Information & Dimensions:

| PART NO. | Dimensions | |
|-------------|------------|-------|
| | A | B |
| A3961WV-2P | 3.96 | 7.92 |
| A3961WV-3P | 7.92 | 11.88 |
| A3961WV-4P | 11.88 | 15.84 |
| A3961WV-5P | 15.84 | 19.80 |
| A3961WV-6P | 19.80 | 23.76 |
| A3961WV-7P | 23.76 | 27.72 |
| A3961WV-8P | 27.72 | 31.68 |
| A3961WV-9P | 31.68 | 35.64 |
| A3961WV-10P | 35.64 | 39.60 |
| A3961WV-11P | 39.60 | 43.56 |
| A3961WV-12P | 43.56 | 47.52 |
| A3961WV-13P | 47.52 | 51.48 |
| A3961WV-14P | 51.48 | 55.44 |
| A3961WV-15P | 55.44 | 59.40 |
| A3961WV-16P | 59.40 | 63.36 |
| A3961WV-17P | 63.36 | 67.32 |
| A3961WV-18P | 67.32 | 71.28 |
| A3961WV-19P | 71.28 | 75.24 |
| A3961WV-20P | 75.24 | 79.20 |
| A3961WV-21P | 79.20 | 83.16 |
| A3961WV-22P | 83.16 | 87.12 |
| A3961WV-23P | 87.12 | 91.08 |
| A3961WV-24P | 91.08 | 95.04 |

Unit: mm

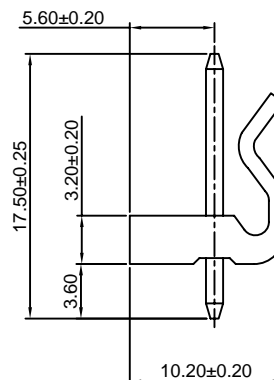
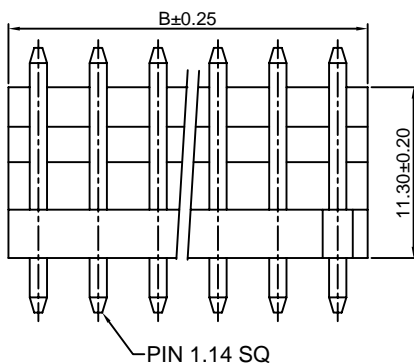
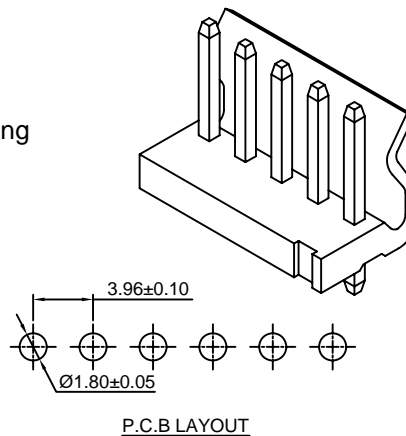
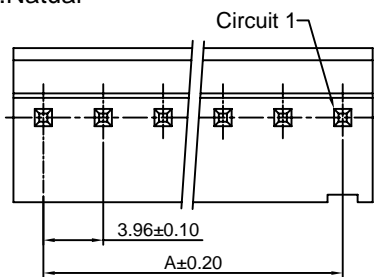

A3961WR-B

3.96mm pitch 90° Wafer

Reference Informations:

- *Material:Pin:Brass/Tin over Nickel
Insulator:Nylon 66,UL94V-2
- *Mates with CJT A3961 or A3964 series Housing
- *Color:Natural

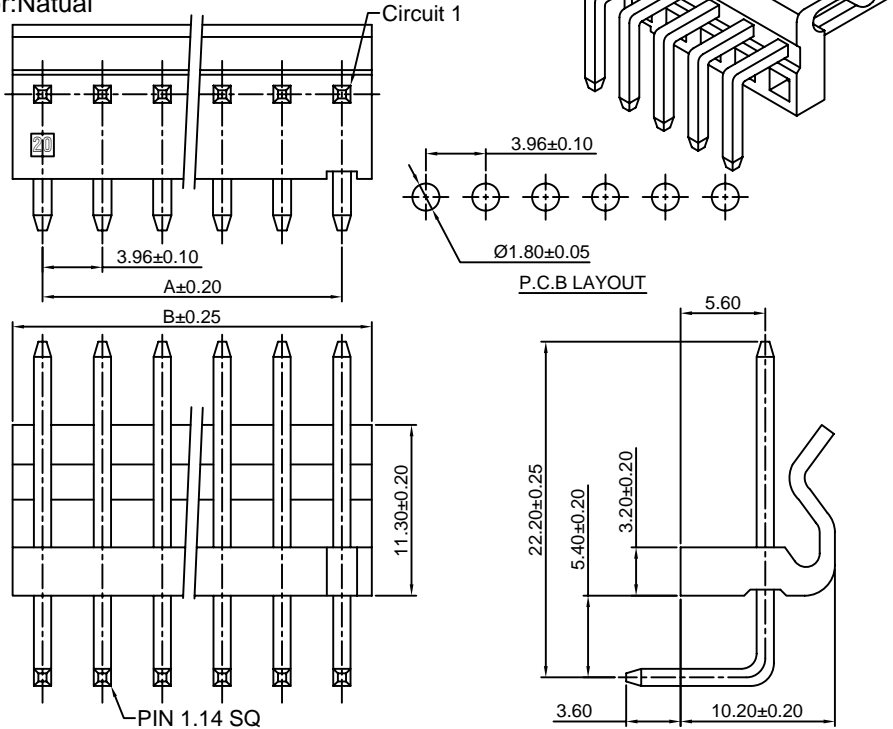

Ordering Information & Dimensions:

| PART NO. | Dimensions | |
|---------------|------------|-------|
| | A | B |
| A3961WR-2P-B | 3.96 | 7.92 |
| A3961WR-3P-B | 7.92 | 11.88 |
| A3961WR-4P-B | 11.88 | 15.84 |
| A3961WR-5P-B | 15.84 | 19.80 |
| A3961WR-6P-B | 19.80 | 23.76 |
| A3961WR-7P-B | 23.76 | 27.72 |
| A3961WR-8P-B | 27.72 | 31.68 |
| A3961WR-9P-B | 31.68 | 35.64 |
| A3961WR-10P-B | 35.64 | 39.60 |
| A3961WR-11P-B | 39.60 | 43.56 |
| A3961WR-12P-B | 43.56 | 47.52 |
| A3961WR-13P-B | 47.52 | 51.48 |
| A3961WR-14P-B | 51.48 | 55.44 |
| A3961WR-15P-B | 55.44 | 59.40 |
| A3961WR-16P-B | 59.40 | 63.36 |
| A3961WR-17P-B | 63.36 | 67.32 |
| A3961WR-18P-B | 67.32 | 71.28 |
| A3961WR-19P-B | 71.28 | 75.24 |
| A3961WR-20P-B | 75.24 | 79.20 |
| A3961WR-21P-B | 79.20 | 83.16 |
| A3961WR-22P-B | 83.16 | 87.12 |
| A3961WR-23P-B | 87.12 | 91.08 |
| A3961WR-24P-B | 91.08 | 95.04 |

Unit: mm

A3961WVA

3.96mm pitch 180° Wafer

Reference Informations:

- *Material:Pin:Brass/Tin over Nickel
Insulator:Nylon 66,UL94V-2
- *Mates with CJT A3961 or A3964 series Housing
- *Color:Natural

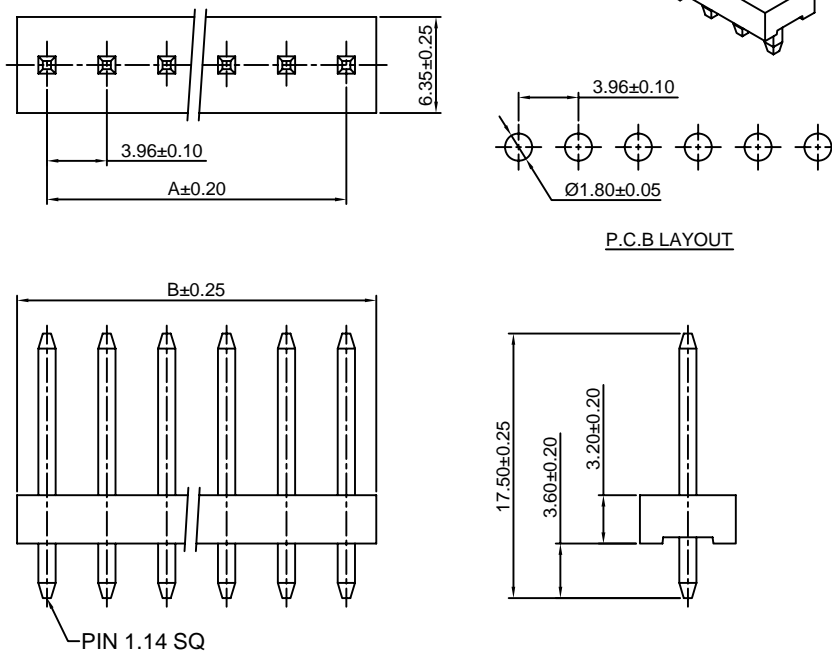

Ordering Information & Dimensions:

| PART NO. | Dimensions | |
|--------------|------------|-------|
| | A | B |
| A3961WVA-2P | 3.96 | 7.92 |
| A3961WVA-3P | 7.92 | 11.88 |
| A3961WVA-4P | 11.88 | 15.84 |
| A3961WVA-5P | 15.84 | 19.80 |
| A3961WVA-6P | 19.80 | 23.76 |
| A3961WVA-7P | 23.76 | 27.72 |
| A3961WVA-8P | 27.72 | 31.68 |
| A3961WVA-9P | 31.68 | 35.64 |
| A3961WVA-10P | 35.64 | 39.60 |
| A3961WVA-11P | 39.60 | 43.56 |
| A3961WVA-12P | 43.56 | 47.52 |
| A3961WVA-13P | 47.52 | 51.48 |
| A3961WVA-14P | 51.48 | 55.44 |
| A3961WVA-15P | 55.44 | 59.40 |
| A3961WVA-16P | 59.40 | 63.36 |
| A3961WVA-17P | 63.36 | 67.32 |
| A3961WVA-18P | 67.32 | 71.28 |
| A3961WVA-19P | 71.28 | 75.24 |
| A3961WVA-20P | 75.24 | 79.20 |
| A3961WVA-21P | 79.20 | 83.16 |
| A3961WVA-22P | 83.16 | 87.12 |
| A3961WVA-23P | 87.12 | 91.08 |
| A3961WVA-24P | 91.08 | 95.04 |

Unit: mm

A3961WRA

3.96mm pitch 90° Wafer

Reference Informations:

- *Material:Pin:Brass/Tin over Nickel
Insulator:Nylon 66,UL94V-2
- *Mates with CJT A3961 or A3964 series Housing
- *Color:Natural

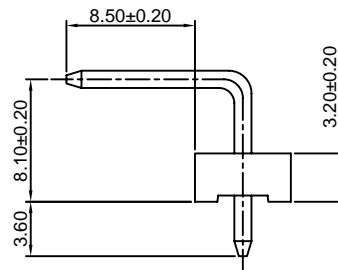
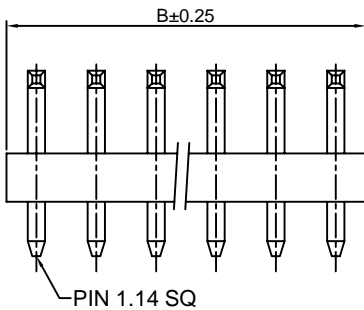
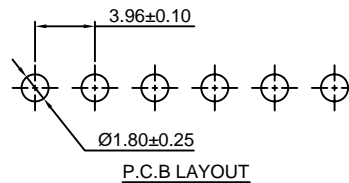
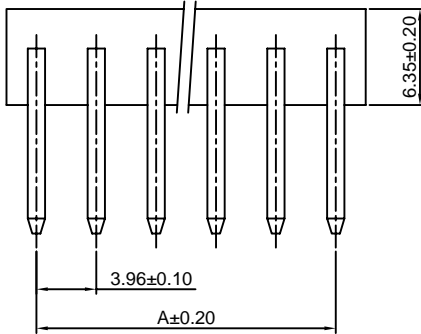
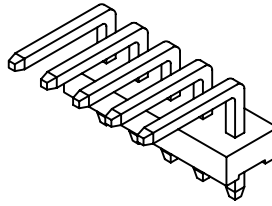

Ordering Information & Dimensions:

| PART NO. | Dimensions | |
|--------------|------------|-------|
| | A | B |
| A3961WRA-2P | 3.96 | 7.92 |
| A3961WRA-3P | 7.92 | 11.88 |
| A3961WRA-4P | 11.88 | 15.84 |
| A3961WRA-5P | 15.84 | 19.80 |
| A3961WRA-6P | 19.80 | 23.76 |
| A3961WRA-7P | 23.76 | 27.72 |
| A3961WRA-8P | 27.72 | 31.68 |
| A3961WRA-9P | 31.68 | 35.64 |
| A3961WRA-10P | 35.64 | 39.60 |
| A3961WRA-11P | 39.60 | 43.56 |
| A3961WRA-12P | 43.56 | 47.52 |
| A3961WRA-13P | 47.52 | 51.48 |
| A3961WRA-14P | 51.48 | 55.44 |
| A3961WRA-15P | 55.44 | 59.40 |
| A3961WRA-16P | 59.40 | 63.36 |
| A3961WRA-17P | 63.36 | 67.32 |
| A3961WRA-18P | 67.32 | 71.28 |
| A3961WRA-19P | 71.28 | 75.24 |
| A3961WRA-20P | 75.24 | 79.20 |
| A3961WRA-21P | 79.20 | 83.16 |
| A3961WRA-22P | 83.16 | 87.12 |
| A3961WRA-23P | 87.12 | 91.08 |
| A3961WRA-24P | 91.08 | 95.04 |

Unit: mm

A3961WV-R

3.96mm pitch 180° Wafer, Round PIN

Reference Informations:

- *Material:Pin:Brass/Tin over Nickel
Insulator:Nylon 66,UL94V-2
- *Mates with CJT A3961 or A3964 series Housing
- *Color:Natural

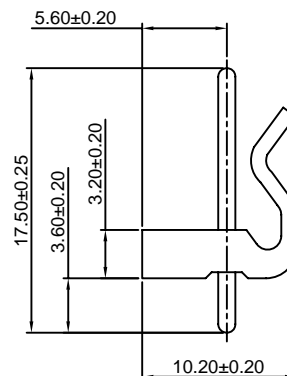
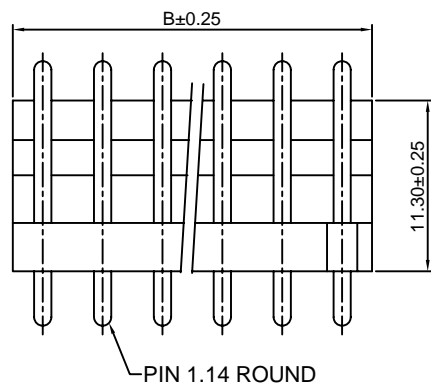
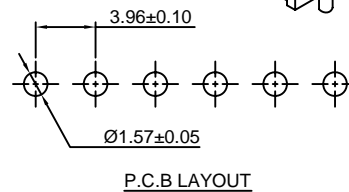
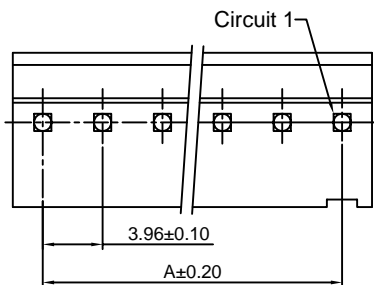
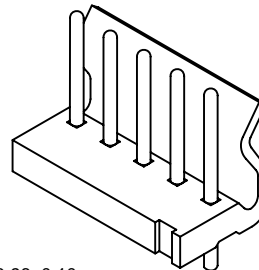

Ordering Information & Dimensions:

| PART NO. | Dimensions | |
|---------------|------------|-------|
| | A | B |
| A3961WV-2P-R | 3.96 | 7.92 |
| A3961WV-3P-R | 7.92 | 11.88 |
| A3961WV-4P-R | 11.88 | 15.84 |
| A3961WV-5P-R | 15.84 | 19.80 |
| A3961WV-6P-R | 19.80 | 23.76 |
| A3961WV-7P-R | 23.76 | 27.72 |
| A3961WV-8P-R | 27.72 | 31.68 |
| A3961WV-9P-R | 31.68 | 35.64 |
| A3961WV-10P-R | 35.64 | 39.60 |
| A3961WV-11P-R | 39.60 | 43.56 |
| A3961WV-12P-R | 43.56 | 47.52 |
| A3961WV-13P-R | 47.52 | 51.48 |
| A3961WV-14P-R | 51.48 | 55.44 |
| A3961WV-15P-R | 55.44 | 59.40 |
| A3961WV-16P-R | 59.40 | 63.36 |
| A3961WV-17P-R | 63.36 | 67.32 |
| A3961WV-18P-R | 67.32 | 71.28 |
| A3961WV-19P-R | 71.28 | 75.24 |
| A3961WV-20P-R | 75.24 | 79.20 |
| A3961WV-21P-R | 79.20 | 83.16 |
| A3961WV-22P-R | 83.16 | 87.12 |
| A3961WV-23P-R | 87.12 | 91.08 |
| A3961WV-24P-R | 91.08 | 95.04 |

Unit: mm

A3961WVA-R

3.96mm pitch 180° Wafer, Round PIN

Reference Informations:

- *Material:Pin:Brass/Tin over Nickel
Insulator:Nylon 66,UL94V-2
- *Mates with CJT A3961 or A3964 series Housing
- *Color:Natural

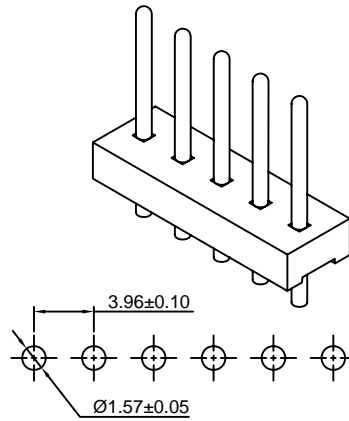
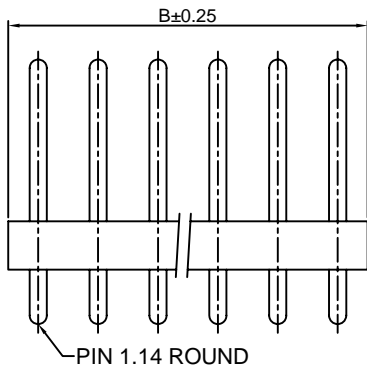
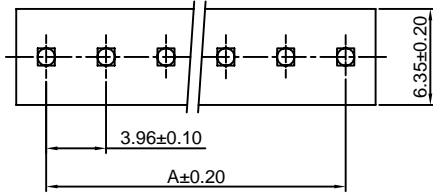

P.C.B LAYOUT

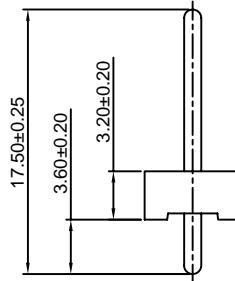

Ordering Information & Dimensions:

| PART NO. | Dimensions | |
|----------------|------------|-------|
| | A | B |
| A3961WVA-2P-R | 3.96 | 7.92 |
| A3961WVA-3P-R | 7.92 | 11.88 |
| A3961WVA-4P-R | 11.88 | 15.84 |
| A3961WVA-5P-R | 15.84 | 19.80 |
| A3961WVA-6P-R | 19.80 | 23.76 |
| A3961WVA-7P-R | 23.76 | 27.72 |
| A3961WVA-8P-R | 27.72 | 31.68 |
| A3961WVA-9P-R | 31.68 | 35.64 |
| A3961WVA-10P-R | 35.64 | 39.60 |
| A3961WVA-11P-R | 39.60 | 43.56 |
| A3961WVA-12P-R | 43.56 | 47.52 |
| A3961WVA-13P-R | 47.52 | 51.48 |
| A3961WVA-14P-R | 51.48 | 55.44 |
| A3961WVA-15P-R | 55.44 | 59.40 |
| A3961WVA-16P-R | 59.40 | 63.36 |
| A3961WVA-17P-R | 63.36 | 67.32 |
| A3961WVA-18P-R | 67.32 | 71.28 |
| A3961WVA-19P-R | 71.28 | 75.24 |
| A3961WVA-20P-R | 75.24 | 79.20 |
| A3961WVA-21P-R | 79.20 | 83.16 |
| A3961WVA-22P-R | 83.16 | 87.12 |
| A3961WVA-23P-R | 87.12 | 91.08 |
| A3961WVA-24P-R | 91.08 | 95.04 |

Unit: mm

A3961WV-A

7.92mm pitch 180° Wafer

Reference Informations:

- *Material: Pin: Brass/Tin over Nickel
Insulator: Nylon 66, UL94V-2
- *Mates with CJT A3961 or A3964 series Housing
- *Color: Natual

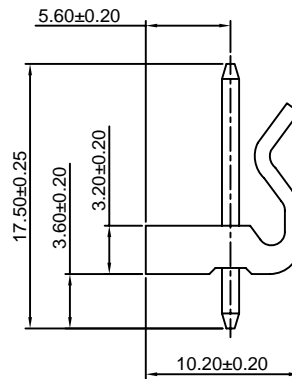
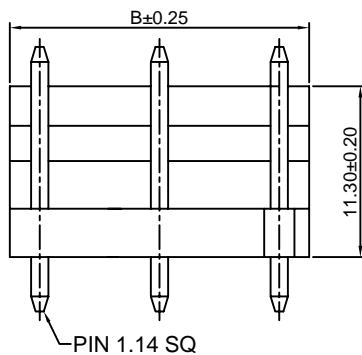
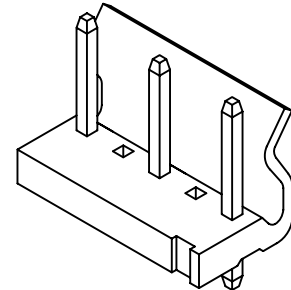
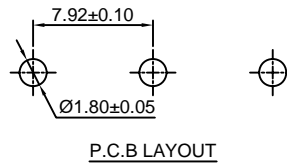
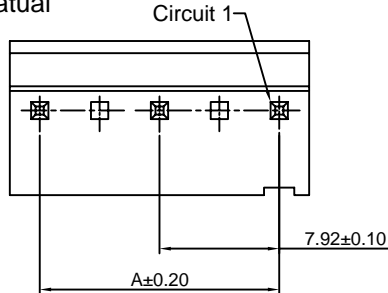

Ordering Information & Dimensions:

| PART NO. | Dimensions | |
|---------------|------------|-------|
| | A | B |
| A3961WV-3P-A | 7.92 | 11.88 |
| A3961WV-5P-A | 15.84 | 19.80 |
| A3961WV-7P-A | 23.76 | 27.72 |
| A3961WV-9P-A | 31.68 | 35.64 |
| A3961WV-11P-A | 39.60 | 43.56 |
| A3961WV-13P-A | 47.52 | 51.48 |
| A3961WV-15P-A | 55.44 | 59.40 |
| A3961WV-17P-A | 63.36 | 67.32 |
| A3961WV-19P-A | 71.28 | 75.24 |

Unit: mm

A3961WR-B-A

7.92mm pitch 90° Wafer

Reference Informations:

- *Material: Pin: Brass/Tin over Nickel
Insulator: Nylon 66, UL94V-2
- *Mates with CJT A3961 or A3964 series Housing
- *Color: Natual

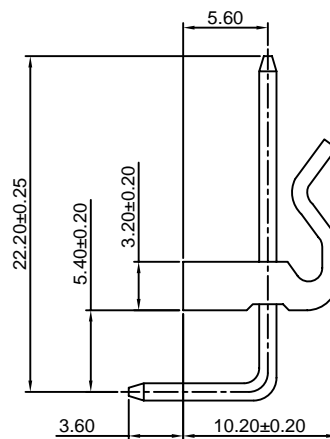
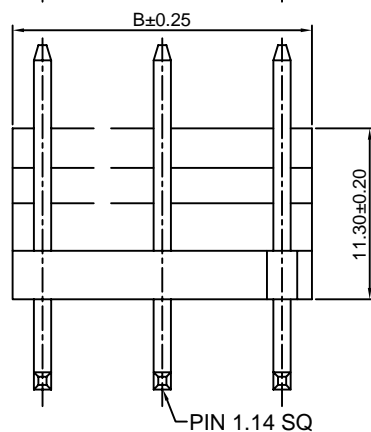
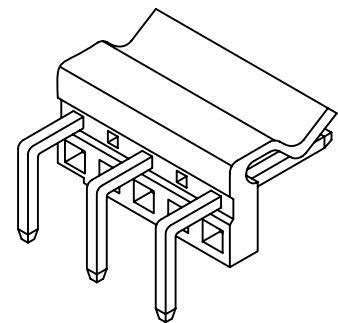
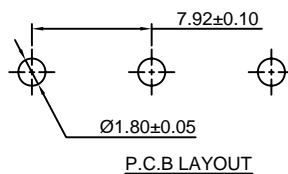
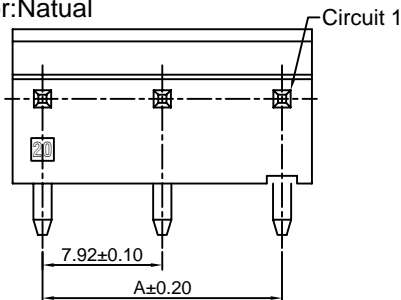

Ordering Information & Dimensions:

| PART NO. | Dimensions | |
|-----------------|------------|-------|
| | A | B |
| A3961WR-3P-B-A | 7.92 | 11.88 |
| A3961WR-5P-B-A | 15.84 | 19.80 |
| A3961WR-7P-B-A | 23.76 | 27.72 |
| A3961WR-9P-B-A | 31.68 | 35.64 |
| A3961WR-11P-B-A | 39.60 | 43.56 |
| A3961WR-13P-B-A | 47.52 | 51.48 |
| A3961WR-15P-B-A | 55.44 | 59.40 |
| A3961WR-17P-B-A | 63.36 | 67.32 |
| A3961WR-19P-B-A | 71.28 | 75.24 |

Unit: mm

A3961WVA-A

7.92mm pitch 180° Wafer

Reference Informations:

- *Material:Pin:Brass/Tin over Nickel
Insulator:Nylon 66,UL94V-2
- *Mates with CJT A3961 or A3964 series Housing
- *Color:Natural

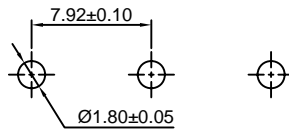
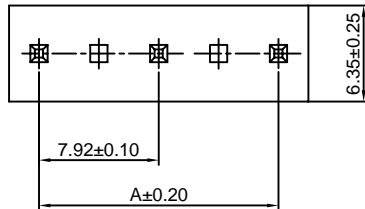

P.C.B LAYOUT

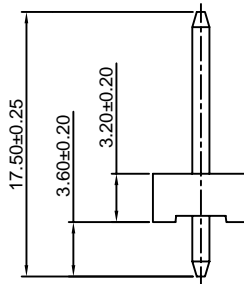
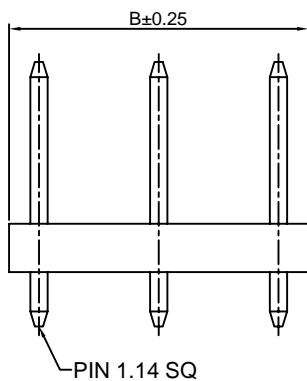
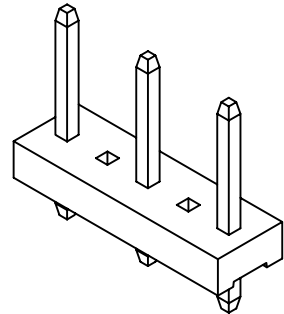

Ordering Information & Dimensions:

| PART NO. | Dimensions | |
|----------------|------------|-------|
| | A | B |
| A3961WVA-3P-A | 7.92 | 11.88 |
| A3961WVA-5P-A | 15.84 | 19.80 |
| A3961WVA-7P-A | 23.76 | 27.72 |
| A3961WVA-9P-A | 31.68 | 35.64 |
| A3961WVA-11P-A | 39.60 | 43.56 |
| A3961WVA-13P-A | 47.52 | 51.48 |
| A3961WVA-15P-A | 55.44 | 59.40 |
| A3961WVA-17P-A | 63.36 | 67.32 |
| A3961WVA-19P-A | 71.28 | 75.24 |

Unit: mm

A3961WRA-A

7.92mm pitch 90° Wafer

Reference Informations:

- *Material:Pin:Brass/Tin over Nickel
Insulator:Nylon 66,UL94V-2
- *Mates with CJT A3961 or A3964 series Housing
- *Color:Natural

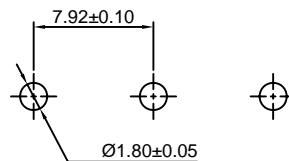
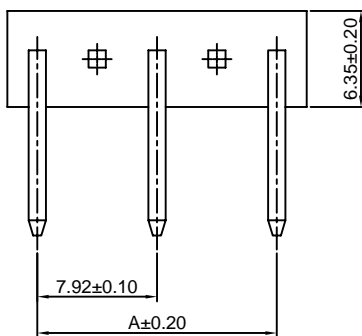

P.C.B LAYOUT

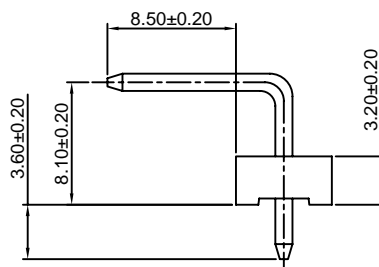
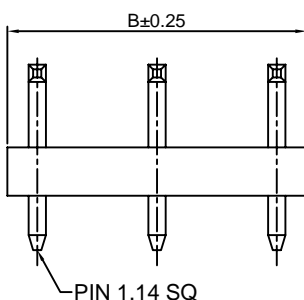
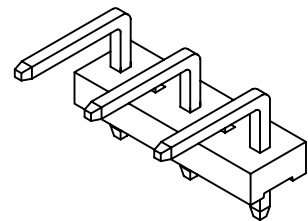

Ordering Information & Dimensions:

| PART NO. | Dimensions | |
|----------------|------------|-------|
| | A | B |
| A3961WRA-3P-A | 7.92 | 11.88 |
| A3961WRA-5P-A | 15.84 | 19.80 |
| A3961WRA-7P-A | 23.76 | 27.72 |
| A3961WRA-9P-A | 31.68 | 35.64 |
| A3961WRA-11P-A | 39.60 | 43.56 |
| A3961WRA-13P-A | 47.52 | 51.48 |
| A3961WRA-15P-A | 55.44 | 59.40 |
| A3961WRA-17P-A | 63.36 | 67.32 |
| A3961WRA-19P-A | 71.28 | 75.24 |

Unit: mm

A3961WV-R-A

7.92mm pitch 180° Wafer

Reference Informations:

- *Material:Pin:Brass/Tin over Nickel
Insulator:Nylon 66,UL94V-2
- *Mates with CJT A3961 or A3964 series Housing
- *Color:Natural

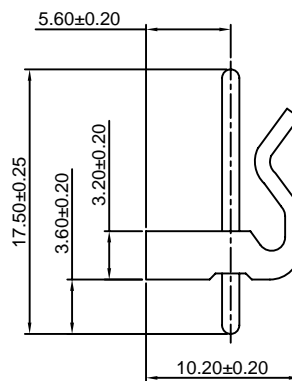
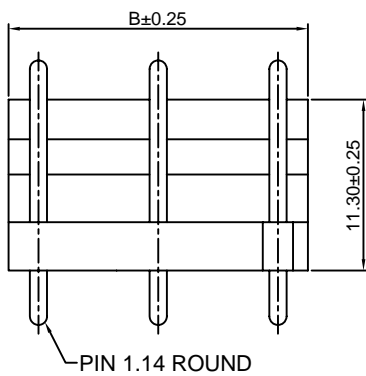
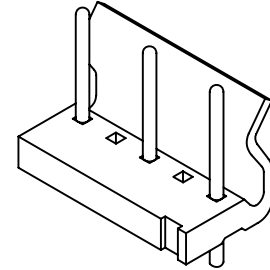
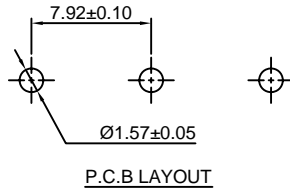
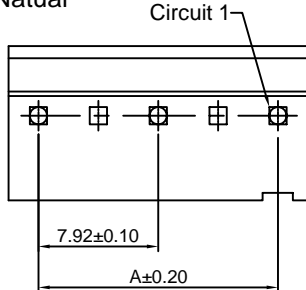

Ordering Information & Dimensions:

| PART NO. | Dimensions | |
|-----------------|------------|-------|
| | A | B |
| A3961WV-3P-R-A | 7.92 | 11.88 |
| A3961WV-5P-R-A | 15.84 | 19.80 |
| A3961WV-7P-R-A | 23.76 | 27.72 |
| A3961WV-9P-R-A | 31.68 | 35.64 |
| A3961WV-11P-R-A | 39.60 | 43.56 |
| A3961WV-13P-R-A | 47.52 | 51.48 |
| A3961WV-15P-R-A | 55.44 | 59.40 |
| A3961WV-17P-R-A | 63.36 | 67.32 |
| A3961WV-19P-R-A | 71.28 | 75.24 |

Unit: mm

A3961WVA-R-A

7.92mm pitch 180° Wafer

Reference Informations:

- *Material:Pin:Brass/Tin over Nickel
Insulator:Nylon 66,UL94V-2
- *Mates with CJT A3961 or A3964 series Housing
- *Color:Natural

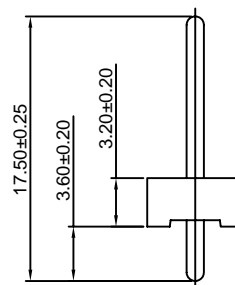
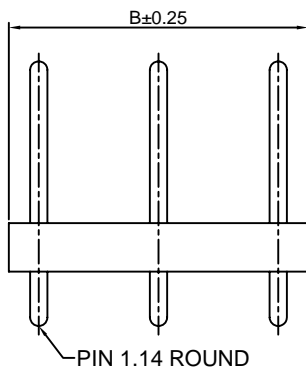
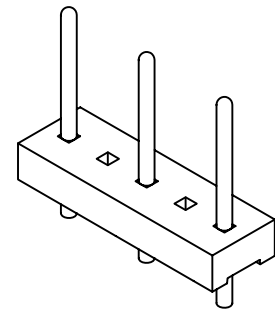
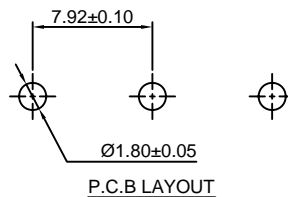
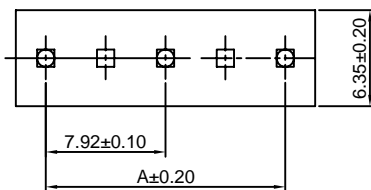

Ordering Information & Dimensions:

| PART NO. | Dimensions | |
|------------------|------------|-------|
| | A | B |
| A3961WVA-3P-R-A | 7.92 | 11.88 |
| A3961WVA-5P-R-A | 15.84 | 19.80 |
| A3961WVA-7P-R-A | 23.76 | 27.72 |
| A3961WVA-9P-R-A | 31.68 | 35.64 |
| A3961WVA-11P-R-A | 39.60 | 43.56 |
| A3961WVA-13P-R-A | 47.52 | 51.48 |
| A3961WVA-15P-R-A | 55.44 | 59.40 |
| A3961WVA-17P-R-A | 63.36 | 67.32 |
| A3961WVA-19P-R-A | 71.28 | 75.24 |

Unit: mm

A3961WVB

3.96mm pitch 180° Wafer

Reference Informations:

- *Material:Pin:Brass/Tin over Nickel
Insulator:Nylon 66,UL94V-0
- *Mates with CJT A3961 or A3964 series Housing
- *Color:White

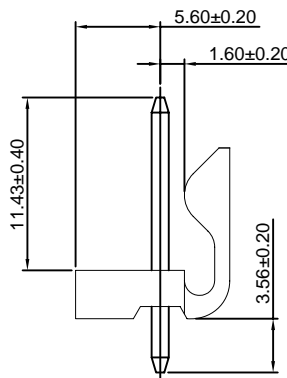
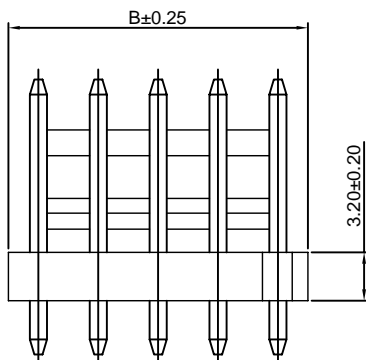
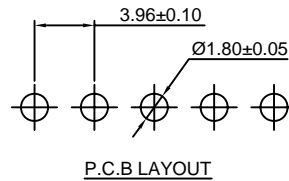
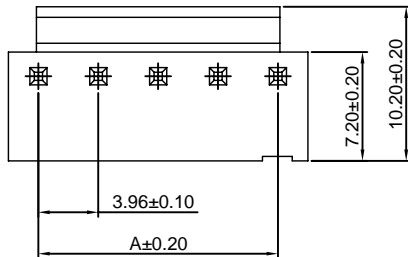

Ordering Information & Dimensions:

| PART NO. | Dimensions | |
|--------------|------------|-------|
| | A | B |
| A3961WVB-2P | 3.96 | 7.92 |
| A3961WVB-3P | 7.92 | 11.88 |
| A3961WVB-4P | 11.88 | 15.84 |
| A3961WVB-5P | 15.84 | 19.80 |
| A3961WVB-6P | 19.80 | 23.76 |
| A3961WVB-7P | 23.76 | 27.72 |
| A3961WVB-8P | 27.72 | 31.68 |
| A3961WVB-9P | 31.68 | 35.64 |
| A3961WVB-10P | 35.64 | 39.60 |
| A3961WVB-11P | 39.60 | 43.56 |
| A3961WVB-12P | 43.56 | 47.52 |
| A3961WVB-13P | 47.52 | 51.48 |
| A3961WVB-14P | 51.48 | 55.44 |
| A3961WVB-15P | 55.44 | 59.40 |
| A3961WVB-16P | 59.40 | 63.36 |
| A3961WVB-17P | 63.36 | 67.32 |
| A3961WVB-18P | 67.32 | 71.28 |
| A3961WVB-19P | 71.28 | 75.24 |
| A3961WVB-20P | 75.24 | 79.20 |

Unit: mm

A3961WVB-F

3.96mm pitch 180° Wafer

Reference Informations:

- *Material:Pin:Brass/Tin over Nickel
Insulator:Nylon 66,UL94V-0
- *Mates with CJT A3961 or A3964 series Housing
- *Color:White

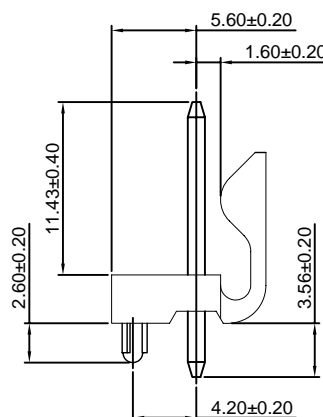
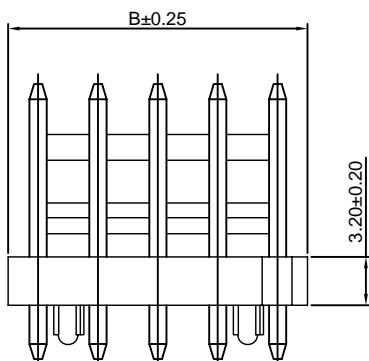
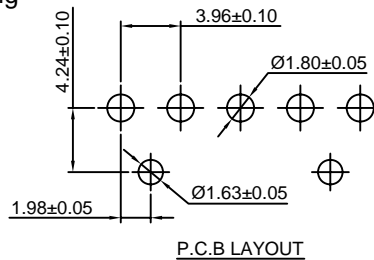
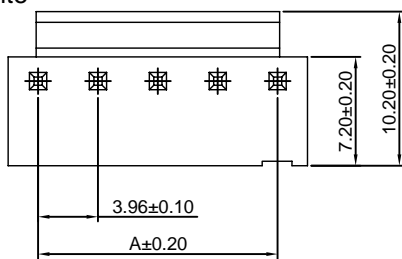

Ordering Information & Dimensions:

| PART NO. | Dimensions | |
|----------------|------------|-------|
| | A | B |
| A3961WVB-F-2P | 3.96 | 7.92 |
| A3961WVB-F-3P | 7.92 | 11.88 |
| A3961WVB-F-4P | 11.88 | 15.84 |
| A3961WVB-F-5P | 15.84 | 19.80 |
| A3961WVB-F-6P | 19.80 | 23.76 |
| A3961WVB-F-7P | 23.76 | 27.72 |
| A3961WVB-F-8P | 27.72 | 31.68 |
| A3961WVB-F-9P | 31.68 | 35.64 |
| A3961WVB-F-10P | 35.64 | 39.60 |
| A3961WVB-F-11P | 39.60 | 43.56 |
| A3961WVB-F-12P | 43.56 | 47.52 |
| A3961WVB-F-13P | 47.52 | 51.48 |
| A3961WVB-F-14P | 51.48 | 55.44 |
| A3961WVB-F-15P | 55.44 | 59.40 |
| A3961WVB-F-16P | 59.40 | 63.36 |
| A3961WVB-F-17P | 63.36 | 67.32 |
| A3961WVB-F-18P | 67.32 | 71.28 |
| A3961WVB-F-19P | 71.28 | 75.24 |
| A3961WVB-F-20P | 75.24 | 79.20 |

Unit: mm

A3961WRB

3.96mm pitch 90° Wafer

Reference Informations:

- *Material:Pin:Brass/Tin over Nickel
Insulator:Nylon 66,UL94V-0
- *Mates with CJT A3961 or A3964 series Housing
- *Color:White

Ordering Information:
A3961WRB-XP - **
1
2

1.Part No.
2.Color:
(blank):White
BK:Black

Ordering Information & Dimensions:

| PART NO. | Dimensions | |
|--------------|------------|-------|
| | A | B |
| A3961WRB-2P | 3.96 | 7.92 |
| A3961WRB-3P | 7.92 | 11.88 |
| A3961WRB-4P | 11.88 | 15.84 |
| A3961WRB-5P | 15.84 | 19.80 |
| A3961WRB-6P | 19.80 | 23.76 |
| A3961WRB-7P | 23.76 | 27.72 |
| A3961WRB-8P | 27.72 | 31.68 |
| A3961WRB-9P | 31.68 | 35.64 |
| A3961WRB-10P | 35.64 | 39.60 |
| A3961WRB-11P | 39.60 | 43.56 |
| A3961WRB-12P | 43.56 | 47.52 |
| A3961WRB-13P | 47.52 | 51.48 |
| A3961WRB-14P | 51.48 | 55.44 |
| A3961WRB-15P | 55.44 | 59.40 |
| A3961WRB-16P | 59.40 | 63.36 |
| A3961WRB-17P | 63.36 | 67.32 |
| A3961WRB-18P | 67.32 | 71.28 |
| A3961WRB-19P | 71.28 | 75.24 |
| A3961WRB-20P | 75.24 | 79.20 |
| A3961WRB-21P | 79.20 | 83.16 |
| A3961WRB-22P | 83.16 | 87.12 |
| A3961WRB-23P | 87.12 | 91.08 |
| A3961WRB-24P | 91.08 | 95.04 |

Unit: mm

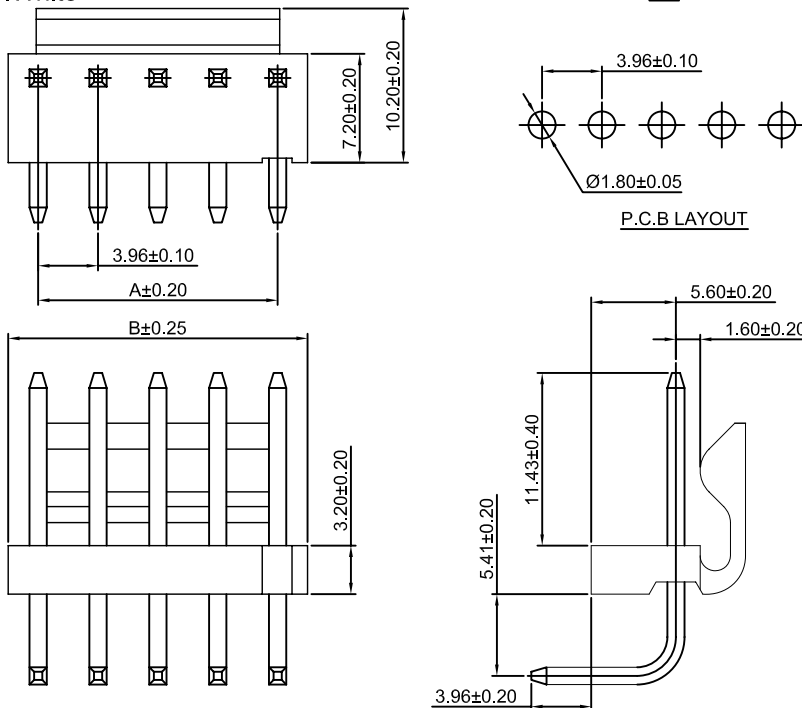

A3961WRB-F

3.96mm pitch 90° Wafer

Reference Informations:

- *Material:Pin:Brass/Tin over Nickel
Insulator:Nylon 66,UL94V-0
- *Mates with CJT A3961 or A3964 series Housing
- *Color:White

Ordering Information & Dimensions:

| PART NO. | Dimensions | |
|----------------|------------|-------|
| | A | B |
| A3961WRB-F-2P | 3.96 | 7.92 |
| A3961WRB-F-3P | 7.92 | 11.88 |
| A3961WRB-F-4P | 11.88 | 15.84 |
| A3961WRB-F-5P | 15.84 | 19.80 |
| A3961WRB-F-6P | 19.80 | 23.76 |
| A3961WRB-F-7P | 23.76 | 27.72 |
| A3961WRB-F-8P | 27.72 | 31.68 |
| A3961WRB-F-9P | 31.68 | 35.64 |
| A3961WRB-F-10P | 35.64 | 39.60 |
| A3961WRB-F-11P | 39.60 | 43.56 |
| A3961WRB-F-12P | 43.56 | 47.52 |
| A3961WRB-F-13P | 47.52 | 51.48 |
| A3961WRB-F-14P | 51.48 | 55.44 |
| A3961WRB-F-15P | 55.44 | 59.40 |
| A3961WRB-F-16P | 59.40 | 63.36 |
| A3961WRB-F-17P | 63.36 | 67.32 |
| A3961WRB-F-18P | 67.32 | 71.28 |
| A3961WRB-F-19P | 71.28 | 75.24 |
| A3961WRB-F-20P | 75.24 | 79.20 |
| A3961WRB-F-21P | 79.20 | 83.16 |
| A3961WRB-F-22P | 83.16 | 87.12 |
| A3961WRB-F-23P | 87.12 | 91.08 |
| A3961WRB-F-24P | 91.08 | 95.04 |

Unit: mm

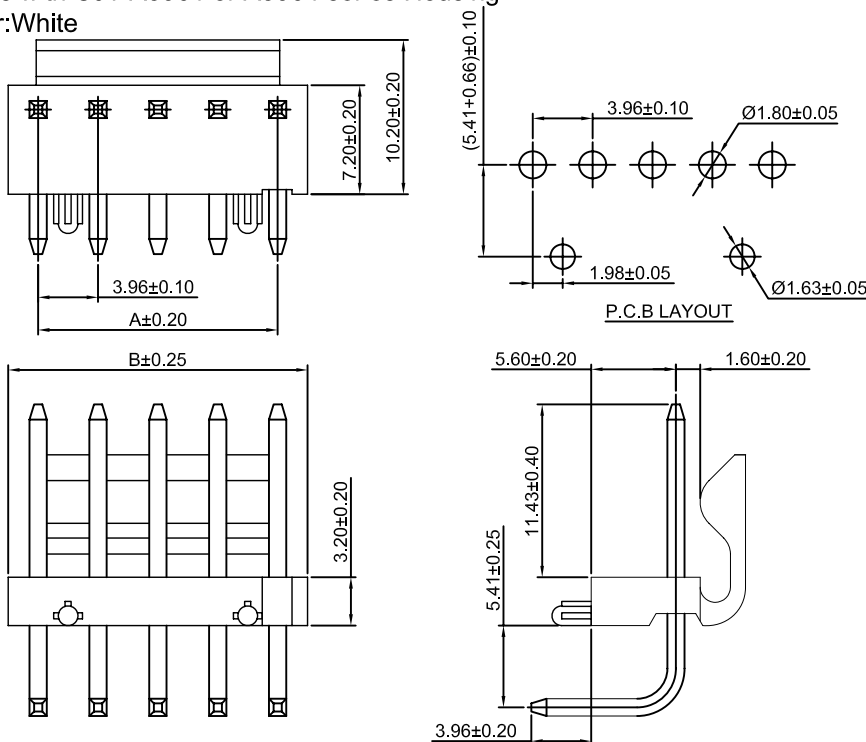

A3961WRB-F-L

3.96mm pitch 90° Wafer

Reference Informations:

- *Material:Pin:Brass/Tin over Nickel
Insulator:Nylon 66,UL94V-0
- *Mates with CJT A3961 or A3964 series Housing
- *Color:White

Ordering Information & Dimensions:

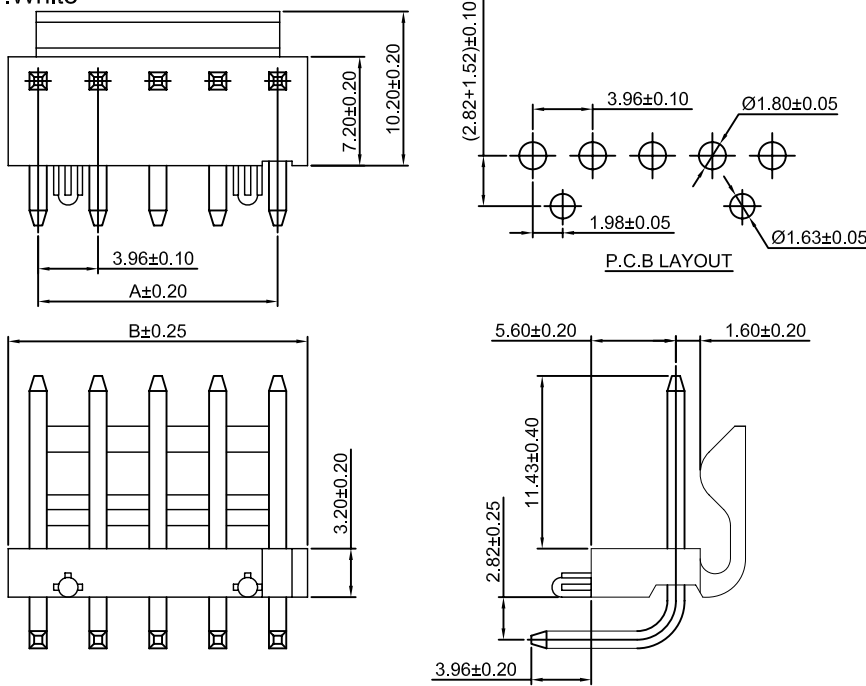

| PART NO. | Dimensions | |
|------------------|------------|-------|
| | A | B |
| A3961WRB-F-L-2P | 3.96 | 7.92 |
| A3961WRB-F-L-3P | 7.92 | 11.88 |
| A3961WRB-F-L-4P | 11.88 | 15.84 |
| A3961WRB-F-L-5P | 15.84 | 19.80 |
| A3961WRB-F-L-6P | 19.80 | 23.76 |
| A3961WRB-F-L-7P | 23.76 | 27.72 |
| A3961WRB-F-L-8P | 27.72 | 31.68 |
| A3961WRB-F-L-9P | 31.68 | 35.64 |
| A3961WRB-F-L-10P | 35.64 | 39.60 |
| A3961WRB-F-L-11P | 39.60 | 43.56 |
| A3961WRB-F-L-12P | 43.56 | 47.52 |
| A3961WRB-F-L-13P | 47.52 | 51.48 |
| A3961WRB-F-L-14P | 51.48 | 55.44 |
| A3961WRB-F-L-15P | 55.44 | 59.40 |
| A3961WRB-F-L-16P | 59.40 | 63.36 |
| A3961WRB-F-L-17P | 63.36 | 67.32 |
| A3961WRB-F-L-18P | 67.32 | 71.28 |
| A3961WRB-F-L-19P | 71.28 | 75.24 |
| A3961WRB-F-L-20P | 75.24 | 79.20 |
| A3961WRB-F-L-21P | 79.20 | 83.16 |
| A3961WRB-F-L-22P | 83.16 | 87.12 |
| A3961WRB-F-L-23P | 87.12 | 91.08 |
| A3961WRB-F-L-24P | 91.08 | 95.04 |

Unit: mm

X-ON Electronics

Largest Supplier of Electrical and Electronic Components

Click to view similar products for [Headers & Wire Housings](#) category:

Click to view products by [Changjiang](#) manufacturer:

Other Similar products are found below :

[57102-F02-18ULF](#) [58102-G61-06LF](#) [0009485154](#) [009176003701906](#) [0050291907](#) [00-9021-0611-00-339](#) [02.125.8002.8](#) [609-3404](#) [61062-3](#)
[622-0430](#) [622-3653LF](#) [63453-116](#) [636-1030](#) [636-1427](#) [636-3427](#) [636-4007](#) [641938-9](#) [644827-2](#) [65495-038](#) [65692-001LF](#) [65781-018](#)
[65781-047](#) [65817-010LF](#) [65817-015LF](#) [66207-023LF](#) [67016-026LF](#) [67095-007LF](#) [68631-112](#) [68645-018](#) [68648-049](#) [699319-000](#)
[70.362.1628.0](#) [70-4210](#) [70-4226B](#) [70-4853B](#) [707-5020](#) [707-5028](#) [71.350.2428.0](#) [71961-016LF](#) [733-134](#) [754199-000](#) [760-3052](#) [787-8014-00](#)
[FCN-367T-T012/H](#) [80.063.4001.1](#) [800-90-001-10-001000](#) [800-90-010-10-002000](#) [801-43-002-10-013000](#) [801-43-006-10-002000](#)
[803-41-018-10-001000](#)