

SOT-363 Plastic-Encapsulate Diodes

BAT54ADW /BAT54BRW / BAT54CDW /BAT54SDW /BAT54TW BAT54DW/BAT54JW

SCHOTTKY BARRIER DIODE ARRAYS

FEATURES

- Low Forward Voltage Drop
- Fast Switching
- Small Surface Mount Package
- PN Junction Guard Ring for Transient and ESD Protection
- Available in Lead Free Version

MARKING:

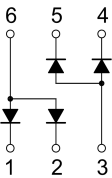
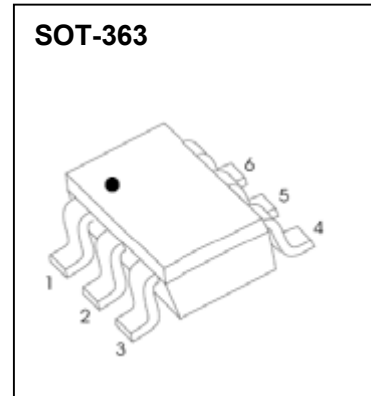

BAT54ADW

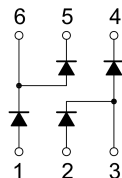

BAT54BRW

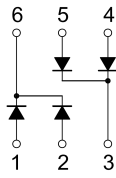

BAT54CDW

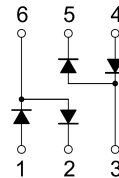

BAT54SDW

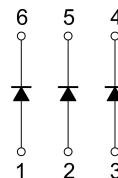



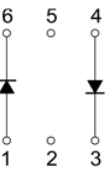

BAT54TW

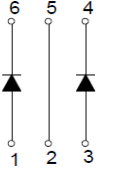



BAT54DW

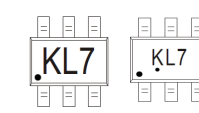

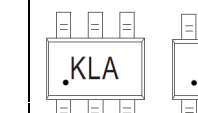
BAT54JW

BAT54ADW	BAT54BRW	BAT54CDW	BAT54SDW	BAT54TW
				

BAT54DW	BAT54JW
	

Solid dot = Green molding compound device,if none, the normal device.

Solid dot = Pin1 indicate.

ELECTRICAL CHARACTERISTICS

MAXIMUM RATINGS ($T_a=25^{\circ}\text{C}$ unless otherwise noted)

Symbol	Parameter	Value	Unit
V_{RRM}	Repetitive Peak Reverse Voltage	30	V
V_{RWM}	Peak Working Reverse Voltage		
V_R	DC Blocking Voltage		
I_O	Forward Continuous Current	200	mA
I_{FRM}	Repetitive Peak Forward Current	300	mA
I_{FSM}	Non-repetitive Peak Forward Surge Current @ $t=8.3\text{ms}$	600	
P_D	Power Dissipation	200	mW
$R_{\theta JA}$	Thermal Resistance From Junction To Ambient	500	$^{\circ}\text{C/W}$
T_j	Junction Temperature	125	$^{\circ}\text{C}$
T_{stg}	Storage Temperature	-55~+150	$^{\circ}\text{C}$

ELECTRICAL CHARACTERISTICS ($T_a=25^{\circ}\text{C}$ unless otherwise specified)

Parameter	Symbol	Test conditions	Min	Typ	Max	Unit
Reverse voltage	$V_{(BR)}$	$I_R=100\mu\text{A}$	30			V
Reverse current	I_R	$V_R=25\text{V}$			2	μA
Forward voltage	V_F	$I_F=1\text{mA}$			320	mV
		$I_F=10\text{mA}$			400	
		$I_F=30\text{mA}$			500	
		$I_F=100\text{mA}$			1000	
Total capacitance	C_{tot}	$V_R=1\text{V}, f=1\text{MHz}$			10	pF
Reverse recovery time	t_{rr}	$I_F=I_R=10\text{mA}, I_{rr}=0.1 \times I_R, R_L=100\Omega$			5	ns

Typical Characteristics

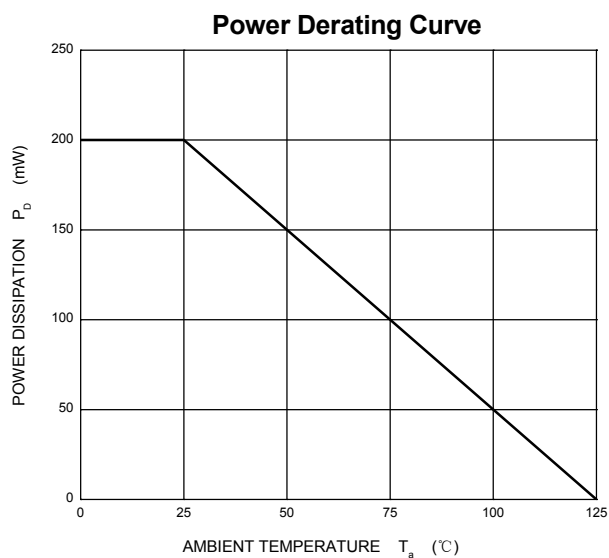
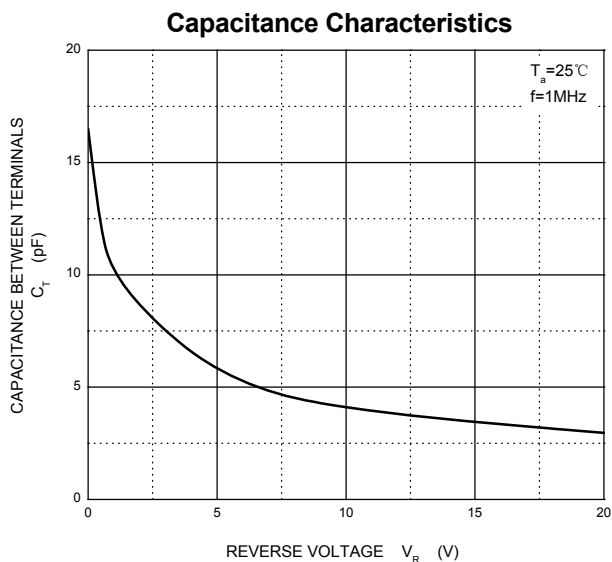
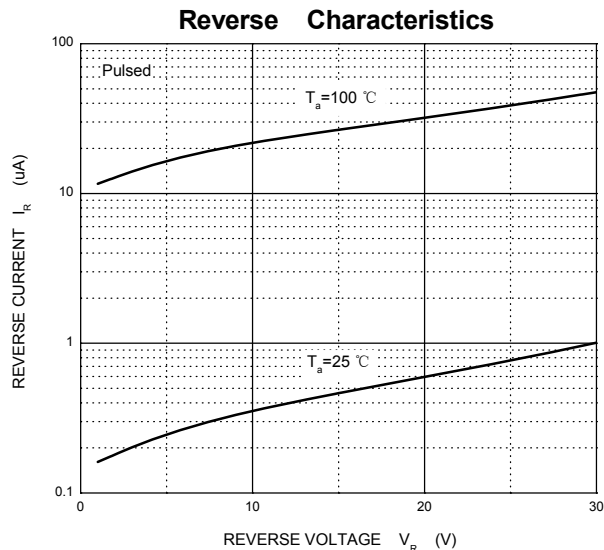
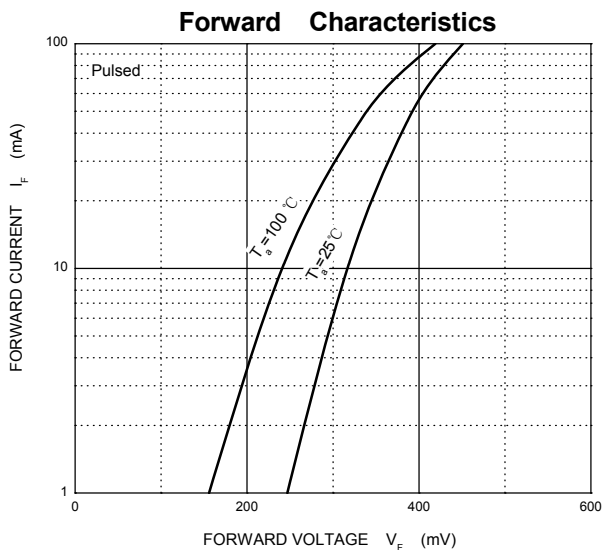

SOT-363 Package Outline Dimensions

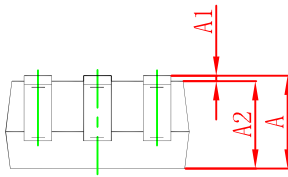
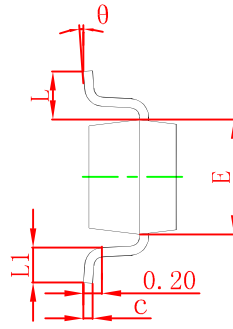
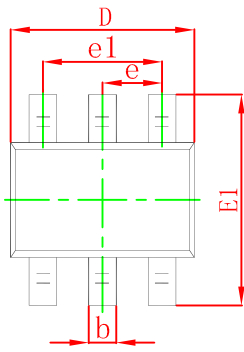

Symbol	Dimensions In Millimeters		Dimensions In Inches	
	Min	Max	Min	Max
A	0.900	1.100	0.035	0.043
A1	0.000	0.100	0.000	0.004
A2	0.900	1.000	0.035	0.039
b	0.150	0.350	0.006	0.014
c	0.100	0.150	0.004	0.006
D	2.000	2.200	0.079	0.087
E	1.150	1.350	0.045	0.053
E1	2.150	2.400	0.085	0.094
e	0.650 TYP		0.026 TYP	
e1	1.200	1.400	0.047	0.055
L	0.525 REF		0.021 REF	
L1	0.260	0.460	0.010	0.018
theta	0°	8°	0°	8°

SOT-363 Suggested Pad Layout

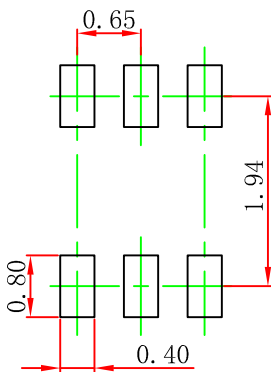

Note:

1. Controlling dimension: in millimeters.
2. General tolerance: $\pm 0.05\text{mm}$.
3. The pad layout is for reference purposes only.

NOTICE

JCET reserve the right to make modifications, enhancements, improvements, corrections or other changes without further notice to any product herein. JCET does not assume any liability arising out of the application or use of any product described herein.

SOT-363 Embossed Carrier Tape

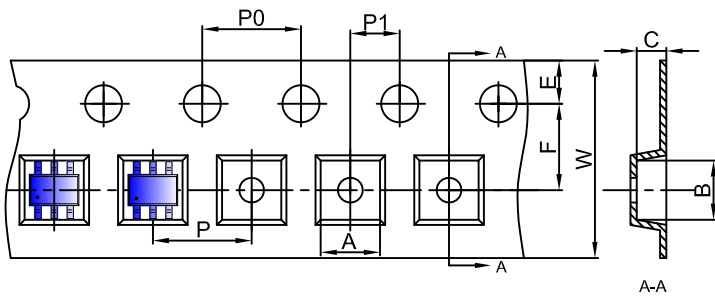

Packaging Description:

SOT-363 parts are shipped in tape. The carrier tape is made from a dissipative (carbon filled) polycarbonate resin. The cover tape is a multilayer film (Heat Activated Adhesive in nature) primarily composed of polyester film, adhesive layer, sealant, and anti-static sprayed agent. These reeled parts in standard option are shipped with 3,000 units per 7" or 17.8cm diameter reel. The reels are clear in color and is made of polystyrene plastic (anti-static coated).

Dimensions are in millimeter										
Pkg type	A	B	C	d	E	F	P0	P	P1	W
SOT-363	2.25	2.55	1.20	Ø1.50	1.75	3.50	4.00	4.00	2.00	8.00

SOT-363 Tape Leader and Trailer

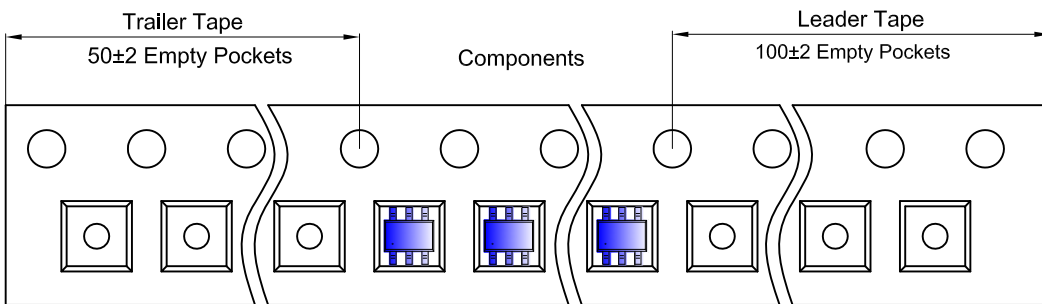

SOT-363 Reel

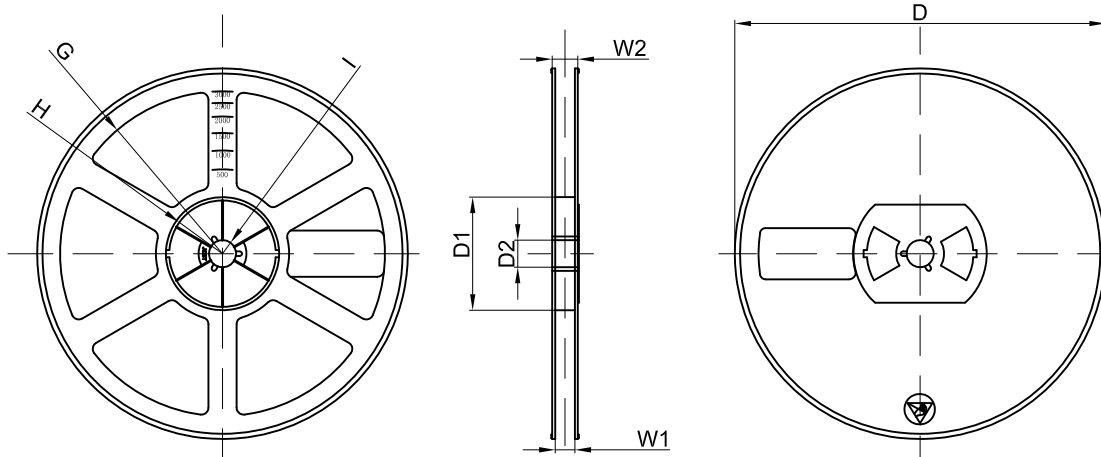

Dimensions are in millimeter								
Reel Option	D	D1	D2	G	H	I	W1	W2
7"Dia	Ø178.00	54.40	13.00	R78.00	R25.60	R6.50	9.50	12.30

REEL	Reel Size	Box	Box Size(mm)	Carton	Carton Size(mm)	G.W.(kg)
3000 pcs	7 inch	45,000 pcs	203×203×195	180,000 pcs	438×438×220	

X-ON Electronics

Largest Supplier of Electrical and Electronic Components

Click to view similar products for [Schottky Diodes & Rectifiers](#) category:

Click to view products by [Changjiang](#) manufacturer:

Other Similar products are found below :

[MA4E2039](#) [MA4E2508M-1112](#) [MBR10100CT-BP](#) [MBR1545CT](#) [MMBD301M3T5G](#) [GS1JE-TP](#) [RB160M-50TR](#) [BAS 3010S-02LRH E6327](#)
[BAT 54-02LRH E6327](#) [NSR05F40QNXT5G](#) [NSVR05F40NXT5G](#) [NTE555](#) [JANS1N6640](#) [SB07-03C-TB-H](#) [SB1003M3-TL-W](#)
[SBAT54CWT1G](#) [SBM30-03-TR-E](#) [SK310-T](#) [SK33A-TP](#) [SK34B-TP](#) [SS3003CH-TL-E](#) [PDS3100Q-7](#) [GA01SHT18](#) [CRS10I30A\(TE85L,QM](#)
[MA4E2501L-1290](#) [MBRB30H30CT-1G](#) [BAS 70-02L E6327](#) [DMJ3940-000](#) [SB007-03C-TB-E](#) [SB10015M-TL-E](#) [SB1003M3-TL-E](#) [SK32A-](#)
[TP](#) [SK33B-TP](#) [SK35A-TP](#) [SK38B-LTP](#) [SK38B-TP](#) [NTE505](#) [NTSB30U100CT-1G](#) [VS-6CWQ10FNHM3](#) [CRG04\(T5L,TEMQ\)](#)
[ACDBA1100LR-HF](#) [ACDBA1200-HF](#) [ACDBA140-HF](#) [ACDBA2100-HF](#) [ACDBA240-HF](#) [ACDBA3100-HF](#) [CDBQC0530L-HF](#) [BAT54-](#)
[13-F](#) [ACDBA340-HF](#) [ACDBA260LR-HF](#)