



>5 B; GI 7 <5 B; >5 B; 9 @7 HF CB 7 G H97 < BC @; M7 C 'Z @8

GCH& 'D'UghjW9 bWUdgi 'UHy' Hf Ubgjghcf g'

.....67, %± TRANSISTOR (NPN)

: 95HI F9G'

- For general AF applications
- High collector current
- High current gain
- Low collector-emitter saturation voltage
- Complementary types: BC807 (PNP)

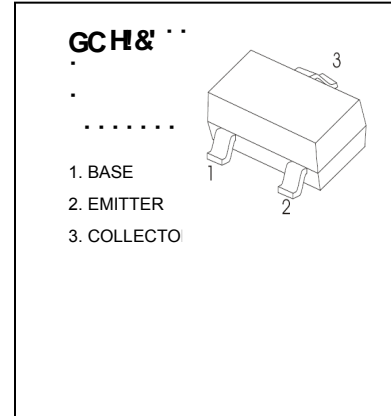

A5L-AI A F5HB; G'fh1&) °C'i b'Ygg'cH Yfk jgY'bcHXL'

Gna Vc''	DUFUa YHyf'	JUi Y'	I bjh
J76c'	Collector-Base Voltage	50	V
J79c'	Collector-Emitter Voltage	45	V
J96c'	Emitter-Base Voltage	5	V
7'	Collector Current -Continuous	0.5	A
D7'	Collector Power Dissipation	0.3	W
H^	Junction Temperature	150	°C
H _{st}	Storage Temperature	-55-150	°C

9 @7 HF 7 5 @7 <5 F57 H9F -GH7 G'fh1&) °C'i b'Ygg'cH Yfk jgY'gdYWZjYXL'

DUFUa YHyf'	Gna Vc''	HYgh VtbX]hcbg'	Ain	Typ'	Aax	Unit
7c''YWcf!VUgYVfYU_Xck b'j'c'HUj Y'	V _{CB0}	I _C = 10μA, I _E =0	50			V
7c''YWcf!Ya jHyf'VfYU_Xck b'j'c'HUj Y'	V _{CE0}	I _C = 10mA, I _B =0	45			V
9a jHyf!VUgYVfYU_Xck b'j'c'HUj Y'	V _{EBO}	I _E = 1μA, I _C =0	5			V
7c''YWcf'W HcZZW ffYbhi	I _{CB0}	V _{CB} = 45 V, I _E =0			0.1	μA
9a jHyf'W HcZZW ffYbhi	I _{EBO}	V _{EB} = 4V, I _C =0			0.1	μA
87'W ffYbhi[Ujb	h _{FE(1)}	V _{CE} = 1V, I _C = 100mA	100		600	
	h _{FE(2)}	V _{CE} = 1V, I _C = 500mA	40			
7c''YWcf!Ya jHyf'gUhi fUjcb'j'c'HUj Y'	V _{CE(sat)}	I _C = 500mA, I _B = 50mA			0.7	V
6 UgY!Ya jHyf'gUhi fUjcb'j'c'HUj Y'	V _{BE(sat)}	I _C = 500mA, I _B = 50mA			1.2	V
6 UgY!Ya jHyf'j'c'HUj Y'	V _{BE}	V _{CE} = 1 V, I _C = 500mA			1.2	V
7c''YWyf'WUdUWjUbW'	C _{ob}	V _{CB} =10V, f=1MHz		10		pF
HfUbgj]hcb'Z'Yei YbWni	f _T	V _{CE} = 5 V, I _C = 10mA f=100MHz	100			MHz

7 @ GG= 7 5 HCB'C: ' hFE'fL'

FUb_'	67, %±1%	67, %±1&)	67, %±!(\$'
FUb[Y'	%%\$!&) \$'	% \$!(\$ \$'	&) \$!* \$ \$'
AUf_]b['	* 5'	* 6'	* 7'

Typical Characteristics

BC817

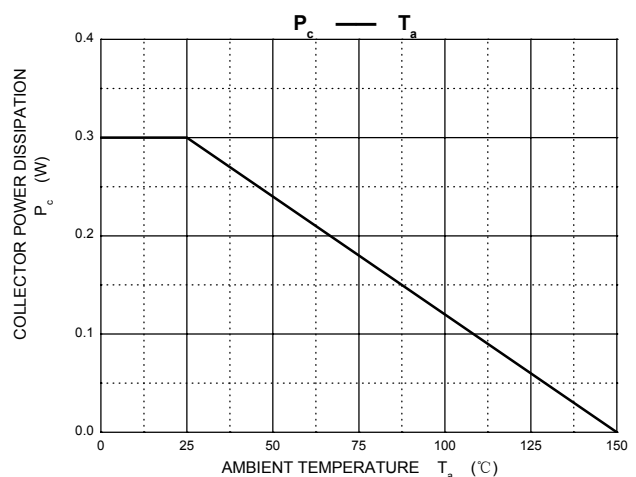
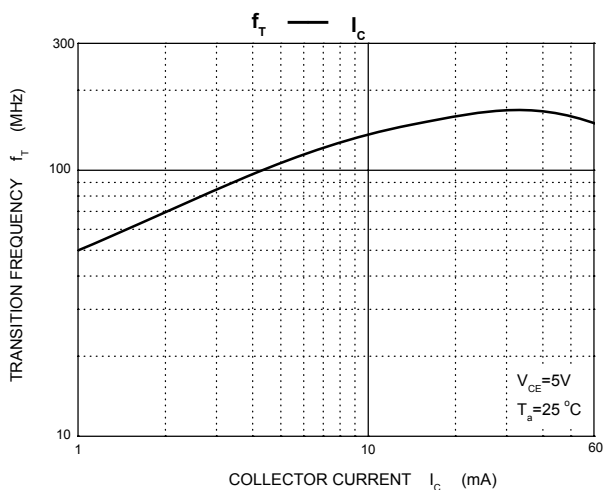
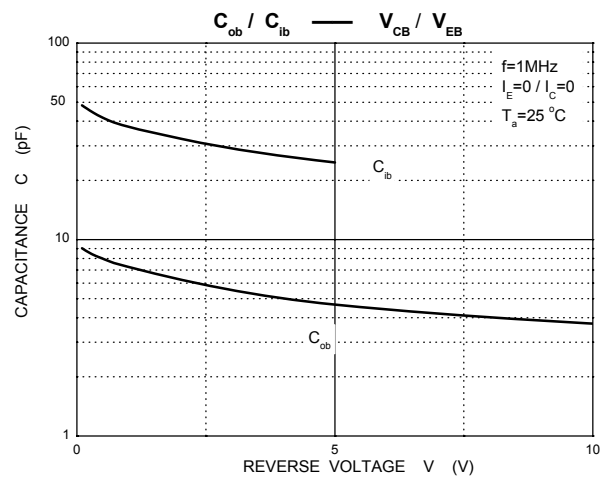
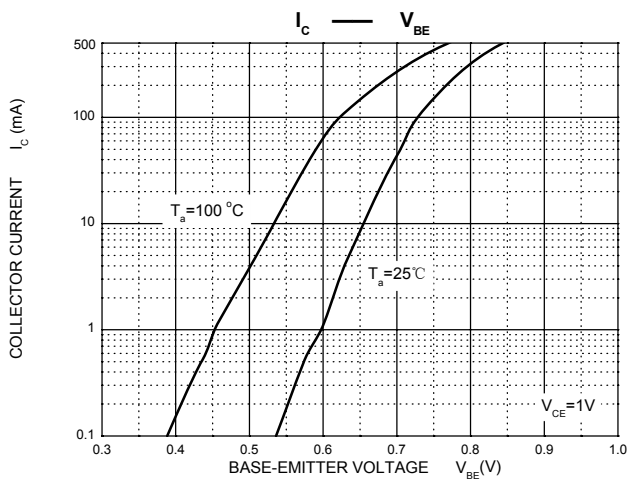
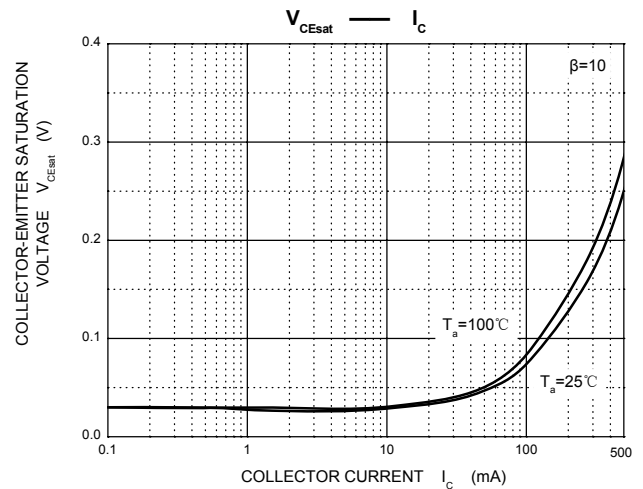
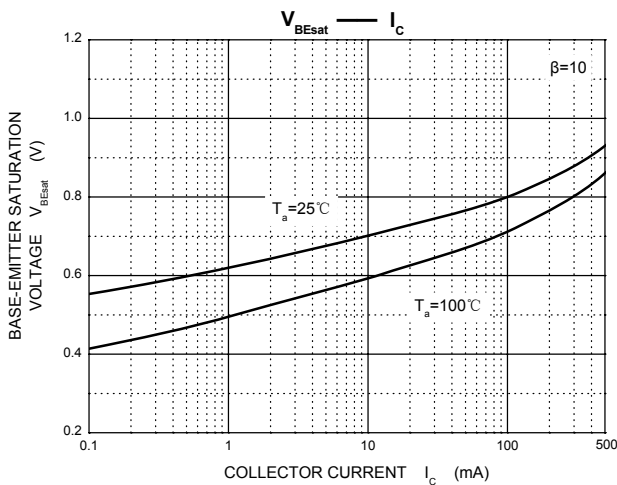
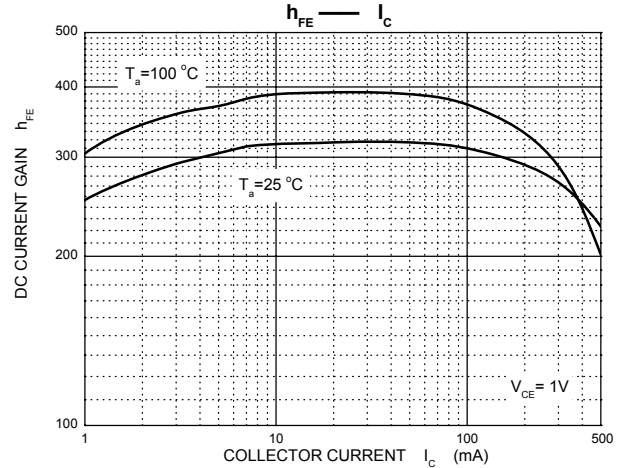
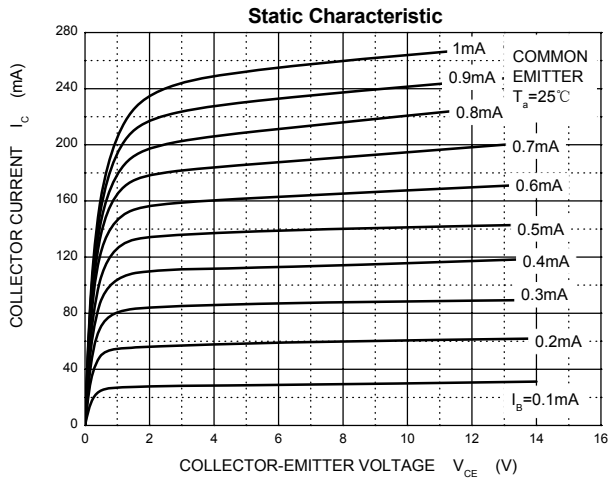

X-ON Electronics

Largest Supplier of Electrical and Electronic Components

Click to view similar products for [Bipolar Transistors - BJT category](#):

Click to view products by [Changjiang manufacturer](#):

Other Similar products are found below :

[619691C](#) [MCH4017-TL-H](#) [MMBT-2369-TR](#) [BC546/116](#) [BC557/116](#) [BSW67A](#) [NJVMJD148T4G](#) [NTE123AP-10](#) [NTE153MCP](#) [NTE16](#)
[NTE195A](#) [NTE92](#) [C4460](#) [2N4401-A](#) [2N6728](#) [2SA1419T-TD-H](#) [2SA2126-E](#) [2SB1204S-TL-E](#) [2SC2712S-GR,LF](#) [2SC5488A-TL-H](#)
[2SD2150T100R](#) [SP000011176](#) [2N2907A](#) [2N3904-NS](#) [2N5769](#) [2SC2412KT146S](#) [2SD1816S-TL-E](#) [CPH6501-TL-E](#) [MCH4021-TL-E](#)
[MJE340](#) [US6T6TR](#) [NJL0281DG](#) [732314D](#) [CPH3121-TL-E](#) [CPH6021-TL-H](#) [873787E](#) [IMZ2AT108](#) [UMX21NTR](#) [MCH6102-TL-E](#)
[NJL0302DG](#) [2N3583](#) [30A02MH-TL-E](#) [NSV40301MZ4T1G](#) [NTE13](#) [NTE26](#) [NTE282](#) [NTE323](#) [NTE350](#) [NTE81](#) [STX83003-AP](#)