

## Specifications

Current rating:5A AC,DC

Voltage rating:250V AC,DC

Temperature range:-40°C~+105°C

Contact resistance:10mΩ Max.

Insulation resistance:1000MΩ Min.

Withstanding voltage:1500V AC/minute

\*Compliant with RoHS and REACH\*

\*Meet the HF/Halogen Free,GWT/Glow wire Test (IEC60335-1) request,need to customize\*

\*Contact CJT for details\*

## Standards



E326732



E326732

## Assembly layout

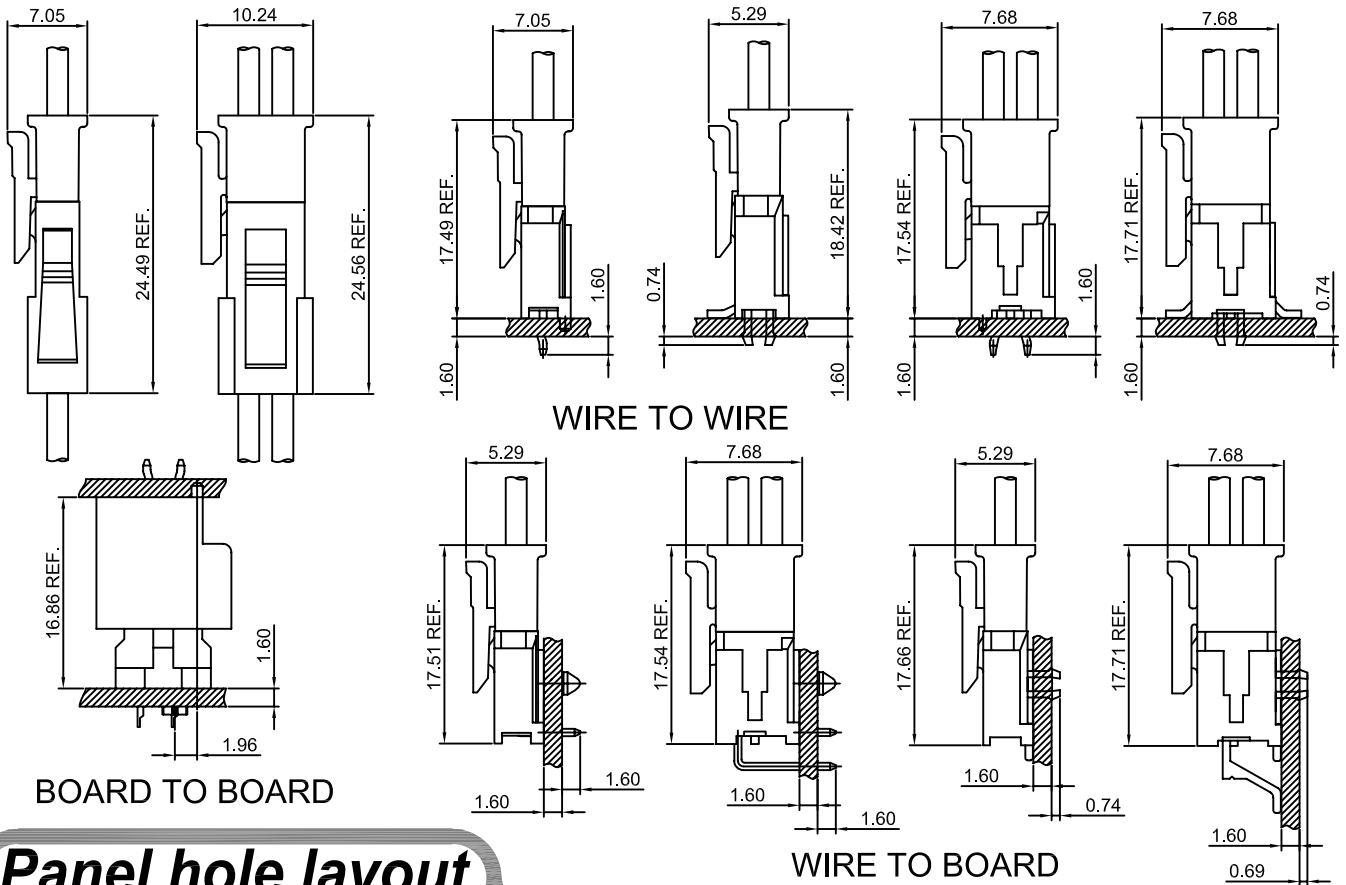

## Panel hole layout

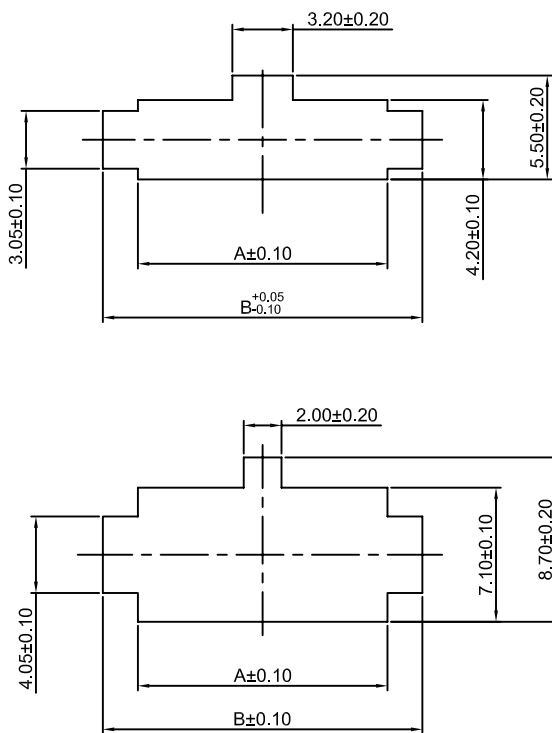

PART NO.		Dimensions	
SINGLE ROW	DUAL ROW	A	B
-----	C3030HM-2X1P(-A)	4.20	7.90
C3030HM-2P	C3030HM-2X2P(-A)	7.20	10.90
C3030HM-3P	C3030HM-2X3P(-A)	10.20	13.90
C3030HM-4P	C3030HM-2X4P(-A)	13.20	16.90
C3030HM-5P	C3030HM-2X5P(-A)	16.20	19.90
C3030HM-6P	C3030HM-2X6P(-A)	19.20	22.90
C3030HM-7P	C3030HM-2X7P(-A)	22.20	25.90
C3030HM-8P	C3030HM-2X8P(-A)	25.20	28.90
C3030HM-9P	C3030HM-2X9P(-A)	28.20	31.90
C3030HM-10P	C3030HM-2X10P(-A)	31.20	34.90
C3030HM-11P	C3030HM-2X11P(-A)	34.20	37.90
C3030HM-12P	C3030HM-2X12P(-A)	37.20	40.90

Unit:mm



# C3030 SERIES

3.00mm pitch wire to wire and wire to board connector

## C3030HF

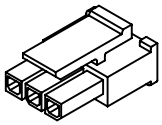

C3030HF

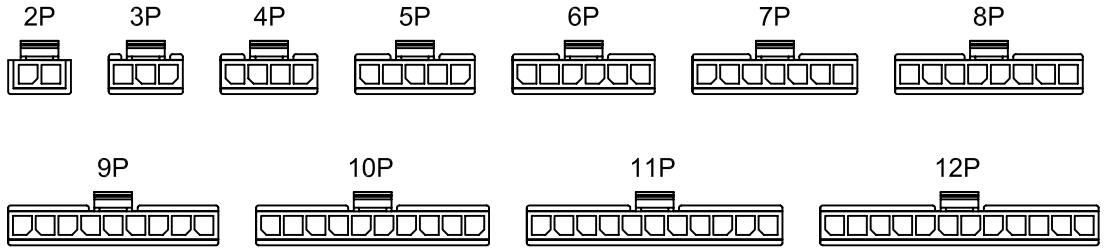

## C3030HM C3030HMA

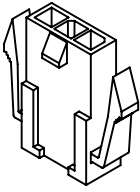

C3030HM

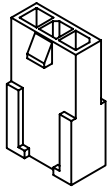

C3030HMA

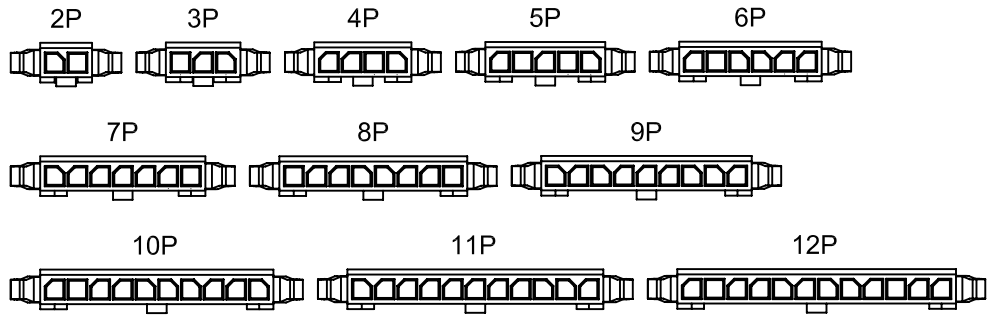

## C3030WV C3030WV-S C3030WV-S-F

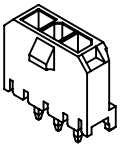

C3030WV

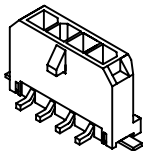

C3030WV-S

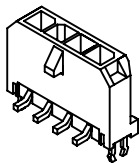

C3030WV-S-F

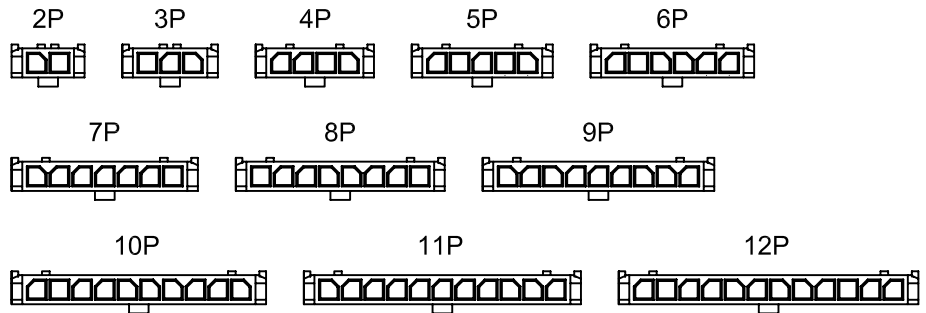

## C3030WR C3030WR-S C3030WR-S-F

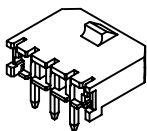

C3030WR

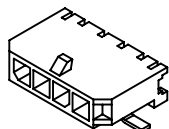

C3030WR-S

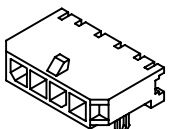

C3030WR-S-F

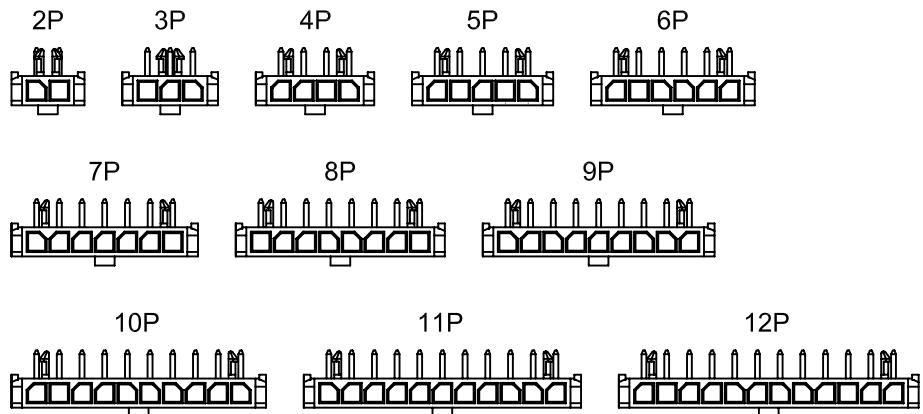



# C3030 SERIES 3.00mm pitch wire to wire and wire to board connector

## C3030HF-2

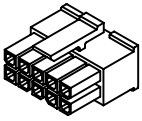

C3030HF-2

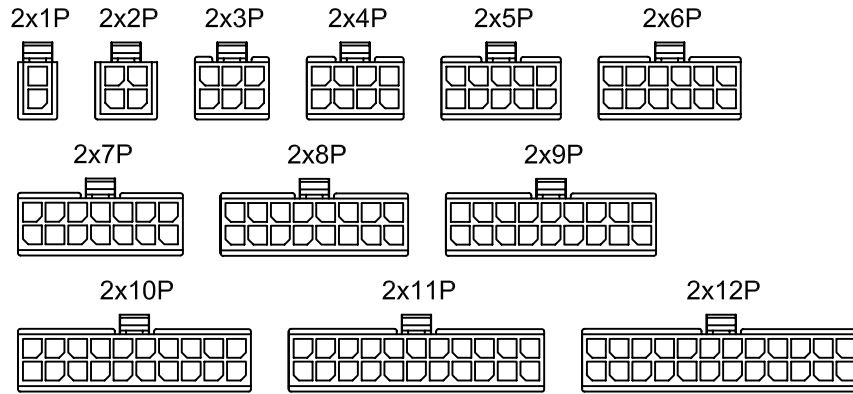

## C3030HM-2 C3030HMA-2 C3030HMC-2

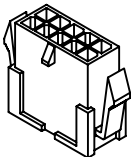

C3030HM-2

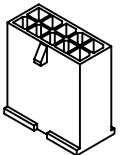

C3030HMC-2

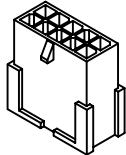

C3030HMA-2

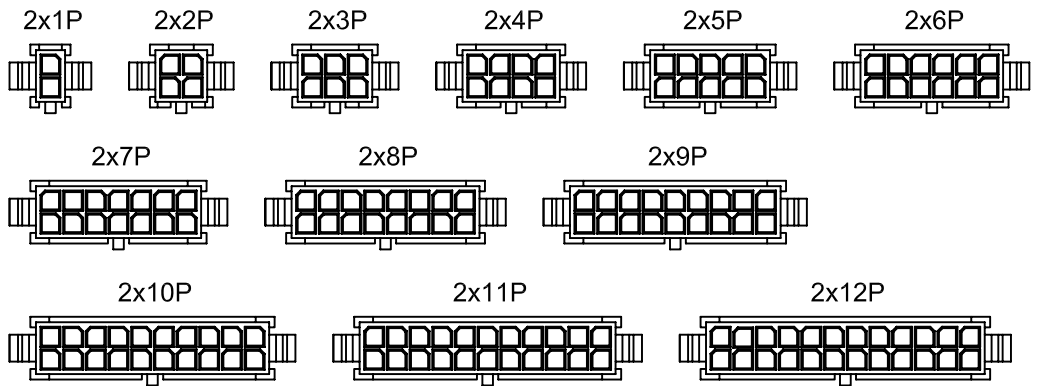

## C3030WV-2 C3030WV-S-2 C3030WV-S-F-2

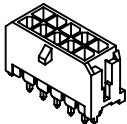

C3030WV-2

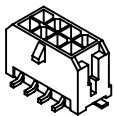

C3030WV-S-2

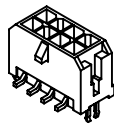

C3030WV-S-F-2

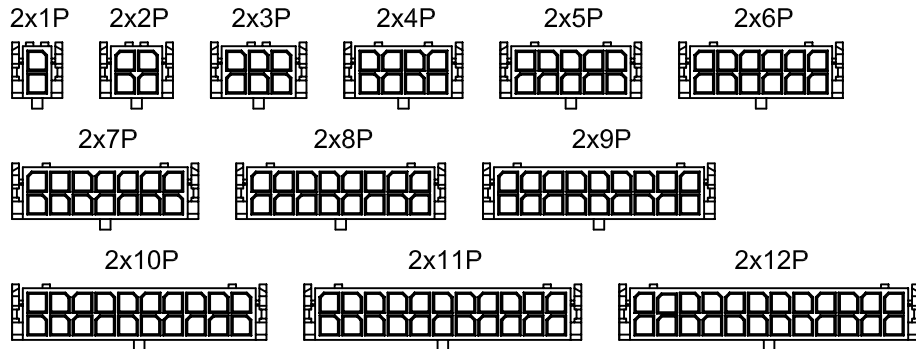

## C3030WR-2 C3030WRA-2 C3030WRA-F-2 C3030WR-S-2 C3030WR-S-F-2

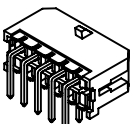

C3030WR-2

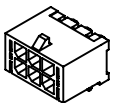

C3030WRA-2

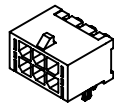

C3030WRA-F-2

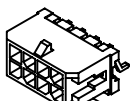

C3030WR-S-2

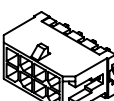

C3030WR-S-F-2

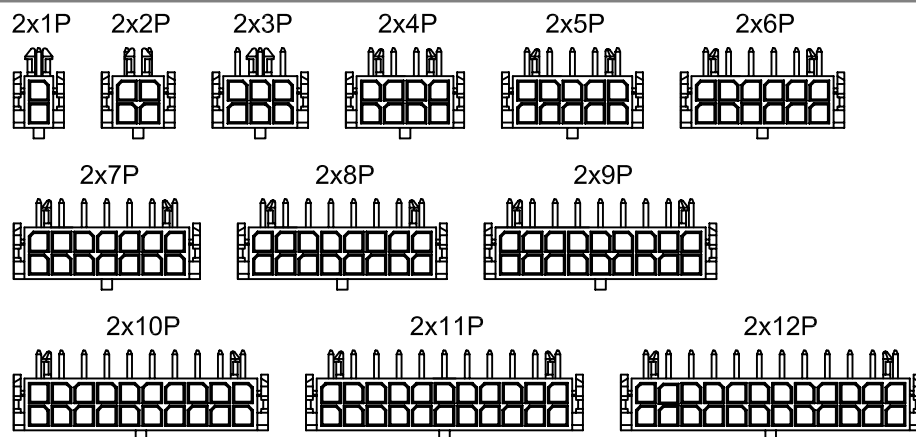





### C3030 SERIES

3.00mm pitch wire to wire and wire to board connector

#### C3030HFB-2

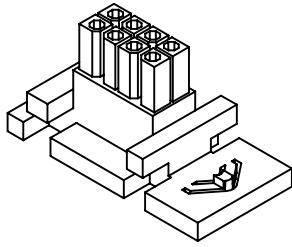

C3030HFB-2

2x1P			2x12P
2x2P			2x11P
2x3P			2x10P
2x4P			2x9P
2x5P			2x8P
2x6P			2x7P

#### C3030HMB-2

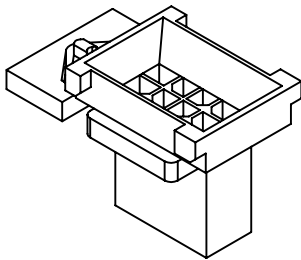

C3030HMB-2

2x1P			2x12P
2x2P			2x11P
2x3P			2x10P
2x4P			2x9P
2x5P			2x8P
2x6P			2x7P



# C3030 SERIES 3.00mm pitch wire to wire and wire to board connector

## C3030F-T-A

3.00mm pitch Crimp Terminal

### Reference Informations:

\*Used in CJT C3030HF-2P~12P, C3030HF-2x1P~2x6P series Housing

Ordering Information:  
C3030F-GP-A(-L) - \*\*\*  
1 2

1.Part No.

2.Finish

(blank): Gold-flash

100µin (2.54µm) MIN.Select Tin

G15:15µin (0.38µm) MIN.Select Gold

100µin (2.54µm) MIN.Select Tin

G30:30µin (0.76µm) MIN.Select Gold

100µin (2.54µm) MIN.Select Tin

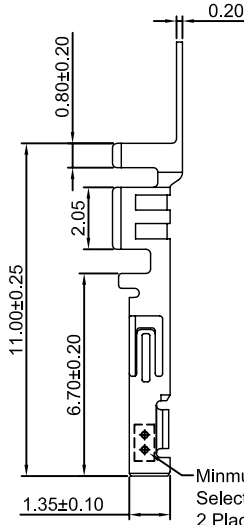
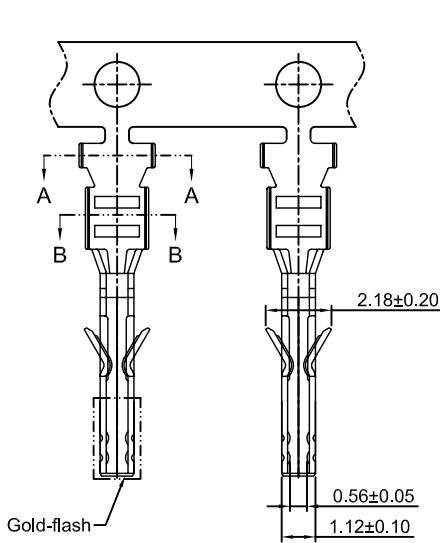

Minmum Area Of  
Select Gold Plating  
2 Places  
(Inside Only)  
(Plating G15 and G30 Only)

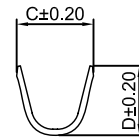

SEC:A-A

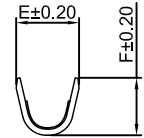

SEC:B-B

### Ordering information & Specifications:

Unit:mm

Part NO	Wire Range	Insulation O.D.	Material	Finish	C	D	E	F	Qty/reel
C3030F-TP-A	AWG#20-#24	1.85mm(max)	Phosphor Bronze	Tin over Nickel	2.54	2.30	2.08	1.90	10,000 PCS
C3030F-GP-A	AWG#20-#24	1.85mm(max)	Phosphor Bronze	Gold-flash	2.54	2.30	2.08	1.90	10,000 PCS
C3030F-TP-A-L	AWG#26-#30	1.27mm(max)	Phosphor Bronze	Tin over Nickel	2.10	1.90	1.65	1.46	10,000 PCS
C3030F-GP-A-L	AWG#26-#30	1.27mm(max)	Phosphor Bronze	Gold-flash	2.10	1.90	1.65	1.46	10,000 PCS

Optional Gold plating available but MOQ requested

## C3030F-T-C

3.00mm pitch Crimp Terminal

### Reference Informations:

\*Used in CJT C3030HF-2x7P~2x12P series Housing

Ordering Information:

C3030F-GP-C - \*\*\*

1 2

1.Part No.

2.Finish

(blank): Gold-flash

100µin (2.54µm) MIN.Select Tin

G15:15µin (0.38µm) MIN.Select Gold

100µin (2.54µm) MIN.Select Tin

G30:30µin (0.76µm) MIN.Select Gold

100µin (2.54µm) MIN.Select Tin

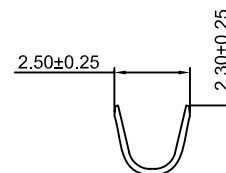
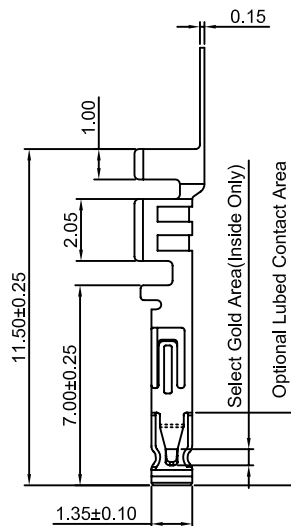
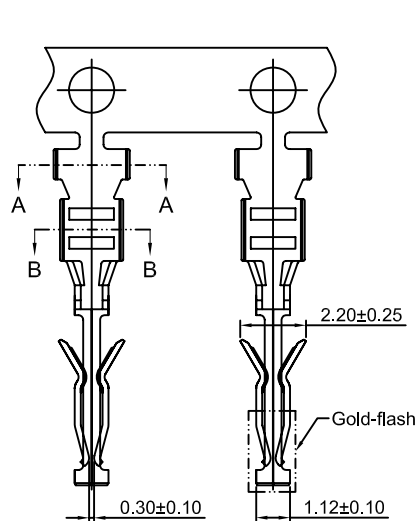

SEC:A-A

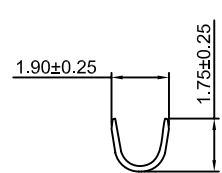

SEC:B-B

### Ordering information & Specifications:

Unit:mm

Part NO	Wire Range	Insulation O.D.	Material	Finish	Qty/reel
C3030F-TP-C	AWG#20-#24	1.85mm(max)	Phosphor Bronze	Tin over Nickel	10,000 PCS
C3030F-GP-C	AWG#20-#24	1.85mm(max)	Phosphor Bronze	Gold-flash	10,000 PCS

Optional Gold plating available but MOQ requested



# C3030 SERIES 3.00mm pitch wire to wire and wire to board connector

## C3030M-T

3.00mm pitch Crimp Terminal

### Reference Informations:

\*Used in CJT C3030HM series Housing

Ordering Information:  
C3030mM-GP (-L) - \*\*  
1 2

1.Part No.

2.Finish

(blank): Gold-flash

100µin (2.54µm) MIN.Select Tin

G15:15µin (0.38µm) MIN.Select Gold

100µin (2.54µm) MIN.Select Tin

G30:30µin (0.76µm) MIN.Select Gold

100µin (2.54µm) MIN.Select Tin

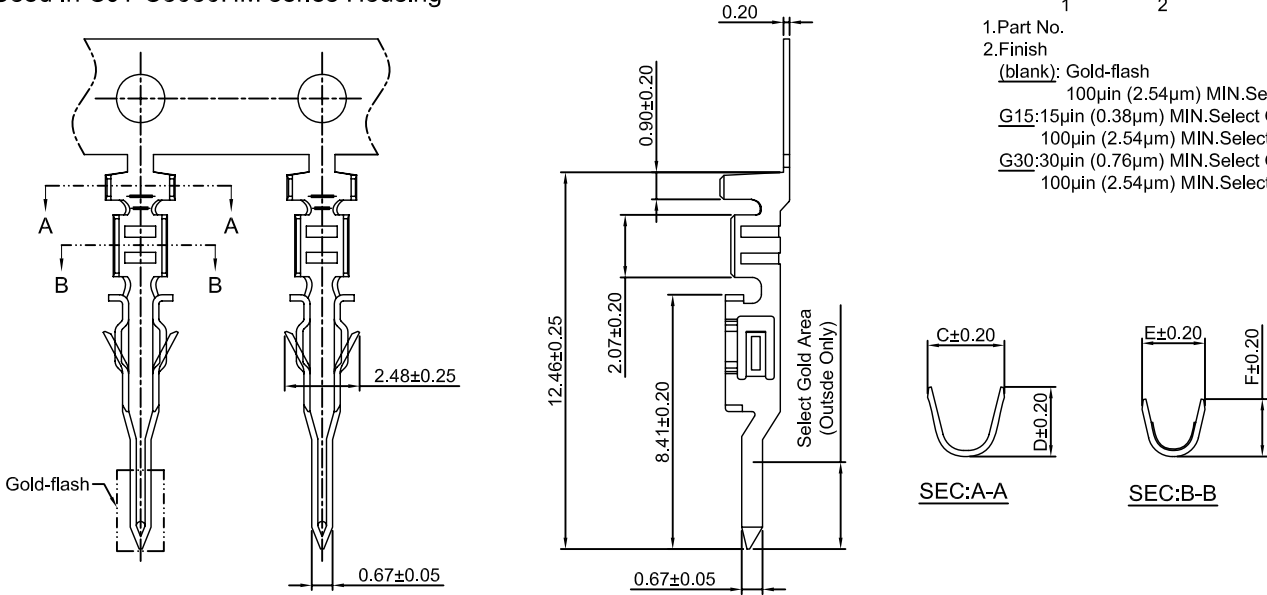

### Ordering information & Specifications:

Unit:mm

Part NO	Wire Range	Insulation O.D.	Material	Finish	C	D	E	F	Qty/reel
C3030M-TP	AWG#20-#24	1.85mm(max)	Phosphor Bronze	Tin over Nickel	2.54	2.30	2.08	1.90	10,000 PCS
C3030M-GP	AWG#20-#24	1.85mm(max)	Phosphor Bronze	Gold-flash	2.54	2.30	2.08	1.90	10,000 PCS
C3030M-TP-L	AWG#26-#30	1.27mm(max)	Phosphor Bronze	Tin over Nickel	2.10	1.90	1.65	1.46	15,000 PCS
C3030M-GP-L	AWG#26-#30	1.27mm(max)	Phosphor Bronze	Gold-flash	2.10	1.90	1.65	1.46	15,000 PCS

Optional Gold plating available but MOQ requested



# C3030 SERIES 3.00mm pitch wire to wire and wire to board connector

## C3030HF-XP

3.00mm Pitch Single Row Housing

### Reference Informations:

- \*Material:Nylon 66,UL94V-0
- \*Suitable CJT C3030F series Terminal
- \*Mates with CJT C3030HM,C3030HMA series Single row Housing or C3030 series single row Wafer
- \*Color:Black

### Ordering Information:

- C3030HF-XP - \*\*\*  
 1 2
- 1.Part No.
  - 2.Material:  
 (blank):Nylon 66,UL94V-0  
 GWT:Nylon 66,UL94V-0,GWT 750 °C

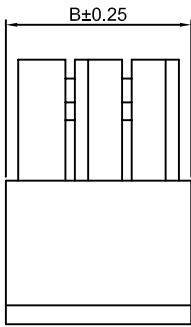
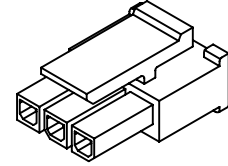
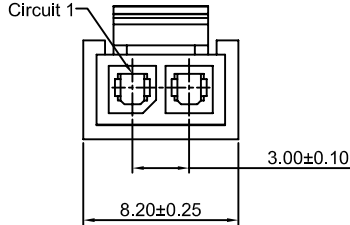
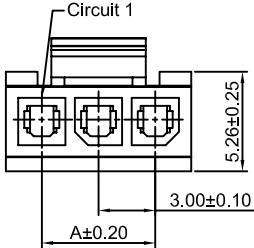

3P~12P

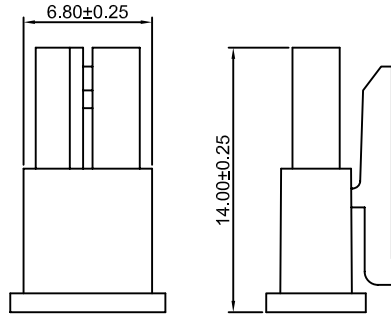

2P

### Ordering Information & Dimensions:

PART NO.	Dimensions	
	A	B
2P	3.00	6.80
3P	6.00	9.80
4P	9.00	12.80
5P	12.00	15.80
6P	15.00	18.80
7P	18.00	21.80
8P	21.00	24.80
9P	24.00	27.80
10P	27.00	30.80
11P	30.00	33.80
12P	33.00	36.80

Unit: mm

## C3030HM-XP

3.00mm Pitch Single Row Housing

### Reference Informations:

- \*Material:Nylon 66,UL94V-0
- \*Suitable CJT C3030M series Terminal
- \*Mates with CJT C3030HF series single row Housing
- \*Color:Black

### Ordering Information:

- C3030HM-XP - \*\*\*  
 1 2
- 1.Part No.
  - 2.Material:  
 (blank):Nylon 66,UL94V-0  
 GWT:Nylon 66,UL94V-0,GWT 750 °C

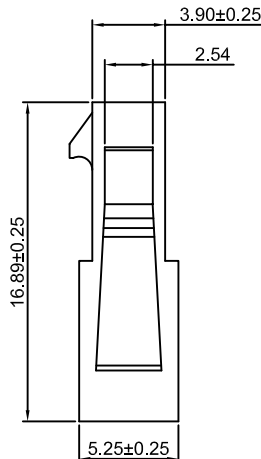
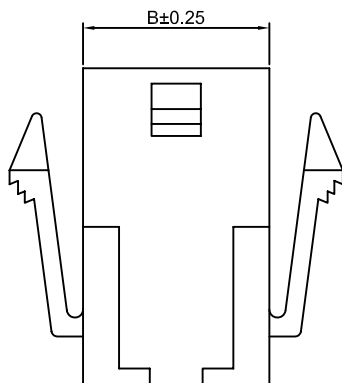
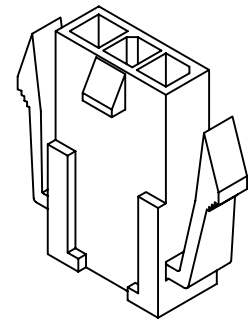
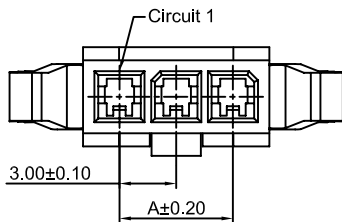

### Ordering Information & Dimensions:

PART NO.	Dimensions	
	A	B
2P	3.00	6.85
3P	6.00	9.85
4P	9.00	12.85
5P	12.00	15.85
6P	15.00	18.85
7P	18.00	21.85
8P	21.00	24.85
9P	24.00	27.85
10P	27.00	30.85
11P	30.00	33.85
12P	33.00	36.85

Unit: mm



# C3030 SERIES

3.00mm pitch wire to wire and wire to board connector

## C3030HMA-XP

3.00mm pitch Single Row Housing

### Reference Informations:

- \*Material:Nylon 66,UL94V-0
- \*Suitable CJT C3030M series Terminal
- \*Mates with CJT C3030HF series single row Housing
- \*Color:Black

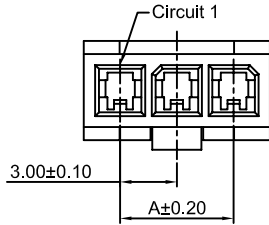

Ordering Information:  
C3030HMA-XP - \*\*\*  
1 2

- 1.Part No.
- 2.Material:  
(blank):Nylon 66,UL94V-0  
GWT:Nylon 66,UL94V-0,GWT 750°C

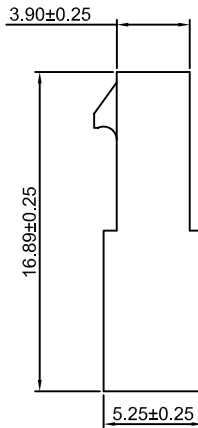
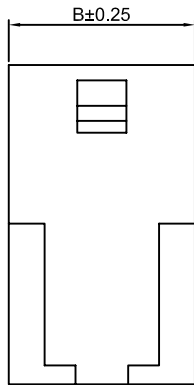
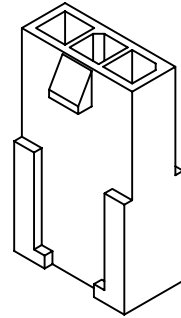

### Ordering Information & Dimensions:

PART NO.	Dimensions	
	A	B
2P	3.00	6.85
3P	6.00	9.85
4P	9.00	12.85
5P	12.00	15.85
6P	15.00	18.85
7P	18.00	21.85
8P	21.00	24.85
9P	24.00	27.85
10P	27.00	30.85
11P	30.00	33.85
12P	33.00	36.85

Unit: mm

## C3030HF-2xXP

3.00mm pitch Dual Row Housing

### Reference Informations:

- \*Material:Nylon 66,UL94V-0
- \*Suitable CJT C3030F series Terminal
- \*Mates with CJT C3030HM,C3030HMA series dual row Housing or C3030 series dual row Wafer
- \*Color:Black

Ordering Information:  
C3030HF-2xXP - \*\*\*  
1 2

- 1.Part No.
- 2.Material:  
(blank):Nylon 66,UL94V-0  
GWT:Nylon 66,UL94V-0,GWT 750°C

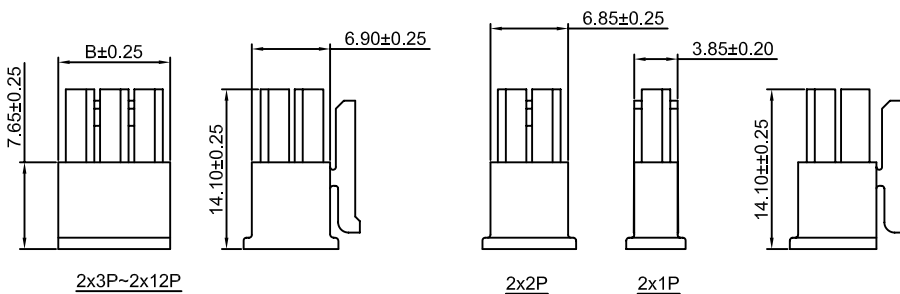
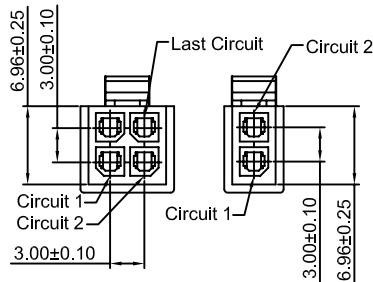
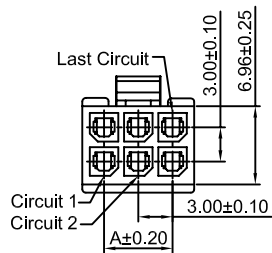
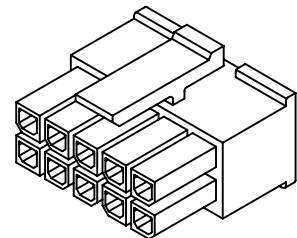

### Ordering Information & Dimensions:

PART NO.	Dimensions	
	A	B
2x1P	----	3.85
2x2P	3.00	6.85
2x3P	6.00	9.85
2x4P	9.00	12.85
2x5P	12.00	15.85
2x6P	15.00	18.85
2x7P	18.00	21.85
2x8P	21.00	24.85
2x9P	24.00	27.85
2x10P	27.00	30.85
2x11P	30.00	33.85
2x12P	33.00	36.85

Unit: mm



**C3030 SERIES**

3.00mm pitch wire to wire and wire to board connector

**C3030HM-2xXP**

3.00mm pitch Dual Row Housing

**Reference Informations:**

- \*Material: Nylon 66, UL94V-0
- \*Suitable CJT C3030M series Terminal
- \*Mates with CJT C3030HF series dual row Housing
- \*Color: Black

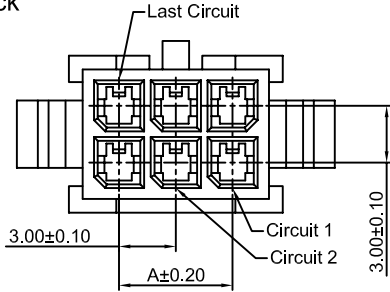

Ordering Information:  
 C3030HM-2xXP - \*\*\*  
 1                          2

1. Part No.  
 2. Material:  
 (blank): Nylon 66, UL94V-0  
 GWT: Nylon 66, UL94V-0, GWT 750°C

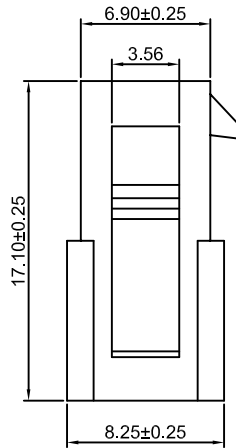
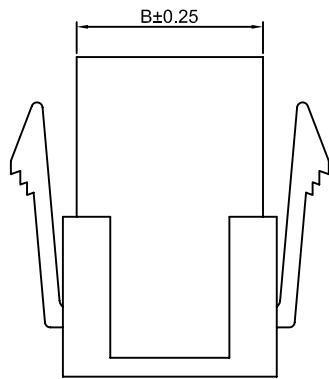
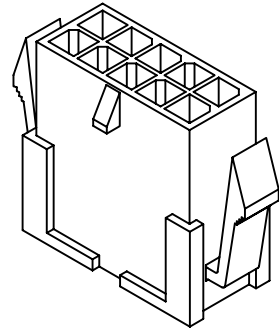

**Ordering Information & Dimensions:**

PART NO.	Dimensions	
	A	B
2x1P	----	3.85
2x2P	3.00	6.85
2x3P	6.00	9.85
2x4P	9.00	12.85
2x5P	12.00	15.85
2x6P	15.00	18.85
2x7P	18.00	21.85
2x8P	21.00	24.85
2x9P	24.00	27.85
2x10P	27.00	30.85
2x11P	30.00	33.85
2x12P	33.00	36.85

Unit: mm

**C3030HM-2xXP-A**

3.00mm pitch Dual Row Housing

**Reference Informations:**

- \*Material: Nylon 66, UL94V-0
- \*Suitable CJT C3030M series Terminal
- \*Mates with CJT C3030HF series dual row Housing
- \*Color: Black

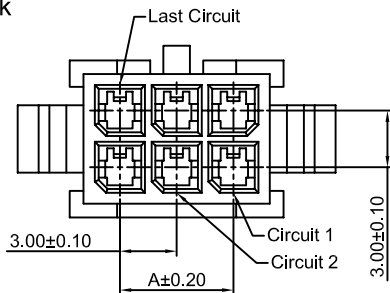

Ordering Information:  
 C3030HM-2xXP-A - \*\*\*  
 1                          2

1. Part No.  
 2. Material:  
 (blank): Nylon 66, UL94V-0  
 GWT: Nylon 66, UL94V-0, GWT 750°C

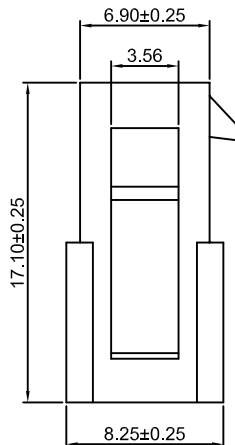
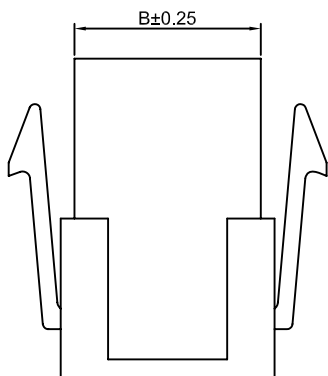
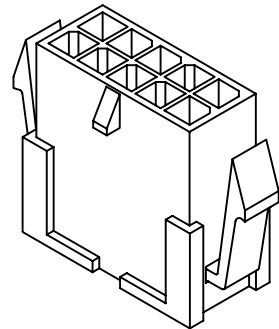

**Ordering Information & Dimensions:**

PART NO.	Dimensions	
	A	B
2x1P	----	3.85
2x2P	3.00	6.85
2x3P	6.00	9.85
2x4P	9.00	12.85
2x5P	12.00	15.85
2x6P	15.00	18.85
2x7P	18.00	21.85
2x8P	21.00	24.85
2x9P	24.00	27.85
2x10P	27.00	30.85
2x11P	30.00	33.85
2x12P	33.00	36.85

Unit: mm



# C3030 SERIES 3.00mm pitch wire to wire and wire to board connector

## C3030HMA-2xXP

3.00mm pitch Dual Row Housing

### Reference Informations:

- \*Material:Nylon 66,UL94V-0
- \*Suitable CJT C3030M series Terminal
- \*Mates with CJT C3030HF series dual row Housing
- \*Color:Black

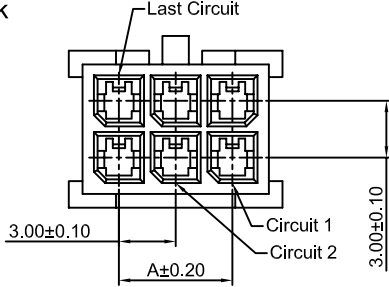

Ordering Information:  
 C3030HMA-2xXP - \*\*\*  
 1 2  
 1.Part No.  
 2.Material:  
 (blank):Nylon 66,UL94V-0  
 GWT:Nylon 66,UL94V-0,GWT 750 °C

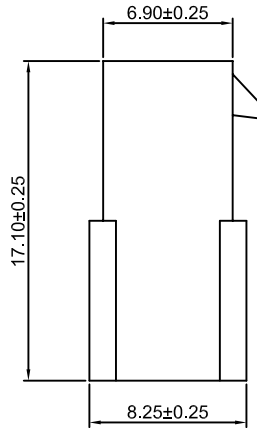
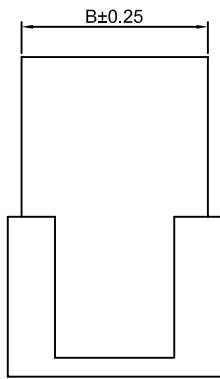
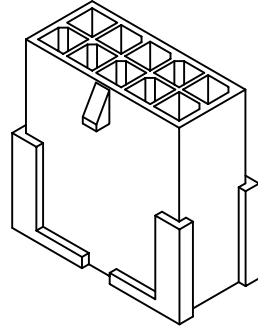

### Ordering Information & Dimensions:

PART NO.	Dimensions	
	A	B
2x1P	----	3.85
2x2P	3.00	6.85
2x3P	6.00	9.85
2x4P	9.00	12.85
2x5P	12.00	15.85
2x6P	15.00	18.85
2x7P	18.00	21.85
2x8P	21.00	24.85
2x9P	24.00	27.85
2x10P	27.00	30.85
2x11P	30.00	33.85
2x12P	33.00	36.85

Unit: mm

## C3030HMC-2xXP

3.00mm pitch Dual Row Housing

### Reference Informations:

- \*Material:Nylon 66,UL94V-0
- \*Suitable CJT C3030M series Terminal
- \*Mates with CJT C3030HF series dual row Housing
- \*Color:Black

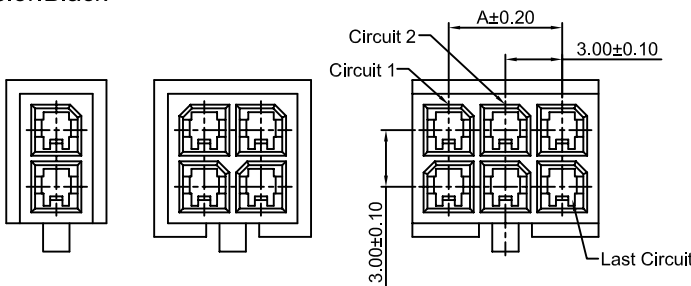

Ordering Information:  
 C3030HMC-2xXP - \*\*\*  
 1 2  
 1.Part No.  
 2.Material:  
 (blank):Nylon 66,UL94V-0  
 GWT:Nylon 66,UL94V-0,GWT 750 °C

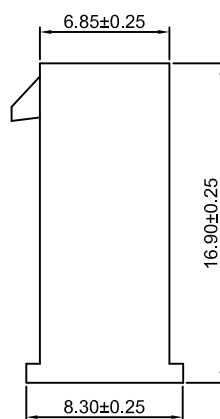
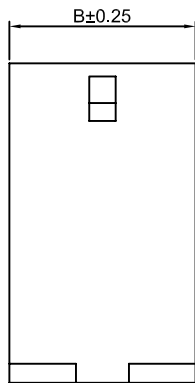
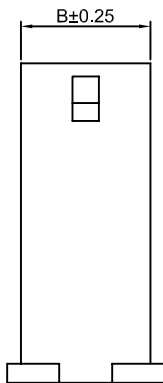
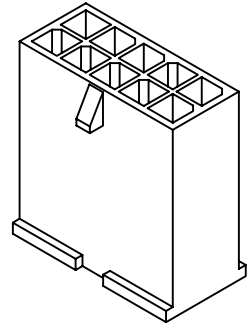

### Ordering Information & Dimensions:

PART NO.	Dimensions	
	A	B
2x1P	----	3.85
2x2P	3.00	6.85
2x3P	6.00	9.85
2x4P	9.00	12.85
2x5P	12.00	15.85
2x6P	15.00	18.85
2x7P	18.00	21.85
2x8P	21.00	24.85
2x9P	24.00	27.85
2x10P	27.00	30.85
2x11P	30.00	33.85
2x12P	33.00	36.85

Unit: mm





# C3030 SERIES 3.00mm pitch wire to wire and wire to board connector

## C3030HFB-2xXP

3.00mm pitch Dual Row Housing

### Reference Informations:

- \*Material:Nylon 66,UL94V-0
- \*Suitable CJT C3030F-T-B(-L) series Terminal
- \*Mates with CJT C3030HMB-2xXP series Housing  
C3030WVB-2xXP,C3030WRB-2xXP Series Wafer
- \*Color:Black

### Ordering Information:

- C3030HFB-2xXP - \*\*\*
- |   |   |
|---|---|
| 1 | 2 |
|---|---|
- Part No.
  - Material:  
(blank):Nylon 66,UL94V-0  
GWT:Nylon 66,UL94V-0,GWT 750°C

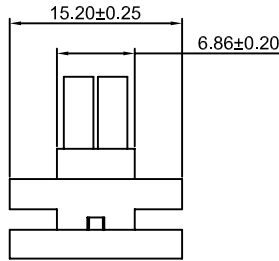
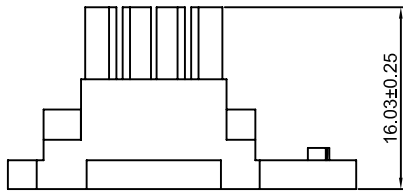
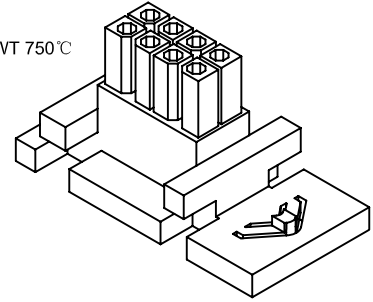
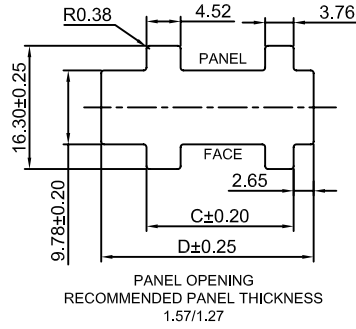
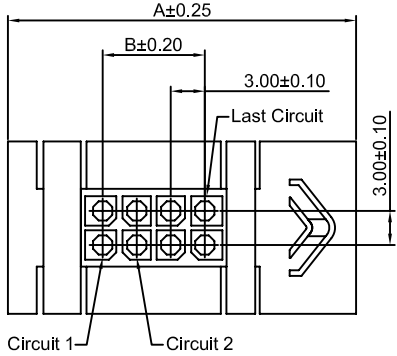

### Ordering Information & Dimensions:

PART NO.	Dimensions			
	A	B	C	D
2x2P	24.70	3.00	13.46	22.10
2x3P	27.70	6.00	16.46	25.10
2x4P	30.70	9.00	19.46	28.10
2x5P	33.70	12.00	22.46	31.10
2x6P	36.70	15.00	25.46	34.10
2x7P	39.70	18.00	28.46	37.10
2x8P	42.70	21.00	31.46	40.10
2x9P	45.70	24.00	34.46	43.10
2x10P	48.70	27.00	37.46	46.10
2x11P	51.70	30.00	40.46	49.10
2x12P	54.70	33.00	43.46	52.10

Unit: mm

## C3030HMB-2xXP

3.00mm pitch Dual Row Housing

### Reference Informations:

- \*Material:Nylon 66,UL94V-0
- \*Suitable CJT C3030M-T(-L) series Terminal
- \*Mates with CJT C3030HFB-2xXP series Housing  
C3030HFWV-2xXP,C3030HFWR-2xXP Receptacle Header
- \*Color:Black

### Ordering Information:

- C3030HMB-2xXP - \*\*\*
- |   |   |
|---|---|
| 1 | 2 |
|---|---|
- Part No.
  - Material:  
(blank):Nylon 66,UL94V-0  
GWT:Nylon 66,UL94V-0,GWT 750°C

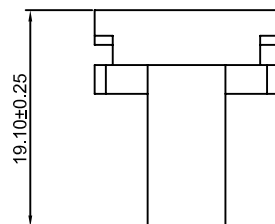
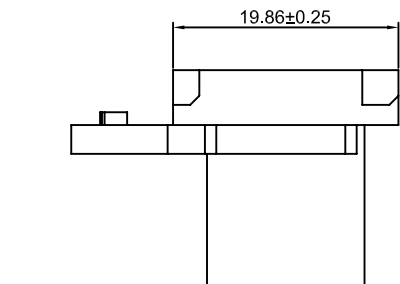
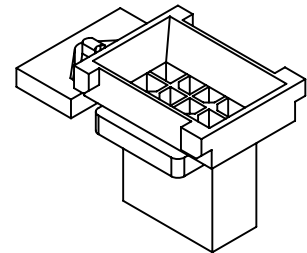
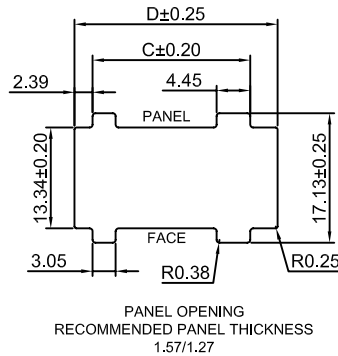
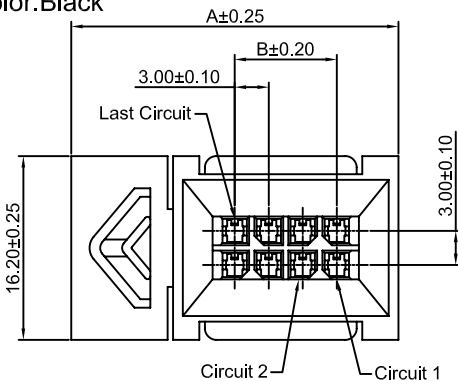

### Ordering Information & Dimensions:

PART NO.	Dimensions			
	A	B	C	D
2x2P	22.84	3.00	14.85	20.85
2x3P	25.84	6.00	17.85	23.85
2x4P	28.84	9.00	20.85	26.85
2x5P	31.84	12.00	23.85	29.85
2x6P	34.84	15.00	26.85	32.85
2x7P	37.84	18.00	29.85	35.85
2x8P	40.84	21.00	32.85	38.85
2x9P	43.84	24.00	35.85	41.85
2x10P	46.84	27.00	38.85	44.85
2x11P	49.84	30.00	41.85	47.85
2x12P	52.84	33.00	44.85	50.85

Unit: mm



# C3030 SERIES 3.00mm pitch wire to wire and wire to board connector

## C3030WV-XP

3.00mm pitch 180° Single Row Wafer

### Reference Informations:

- \*Material:Pin:Brass/Tin over Nickel  
Insulator:Nylon 66,UL94V-0
- \*Mates with CJT C3030HF-XP series Housing
- \*Color:Black

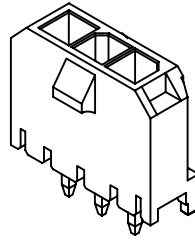
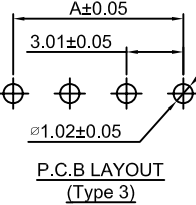
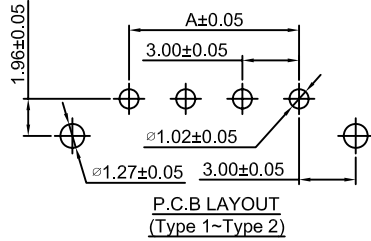
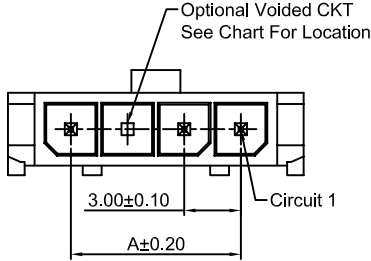

- Ordering Information:  
C3030WV-XP - \* - \*\*\* - \*\*  
1 2 3 4
- 1.Part No.
  - 2.Style:  
(blank) :Type 1  
2 :Type 2  
3 :Type 3
  - 3.Material:  
(blank):Nylon66, UL94V-0  
LCP:LCP,UL94V-0  
GWT:LCP,UL94V-0,GWT 750°C
  - 4.Finish  
(blank):Tin over Nickel  
G:Gold-flash  
G15:15µin (0.38µm) MIN.Select Gold  
100µin (2.54µm) MIN.Select Tin  
G30:30µin (0.76µm) MIN.Select Gold  
100µin (2.54µm) MIN.Select Tin

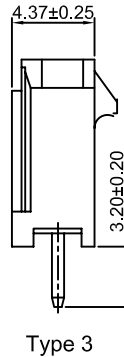
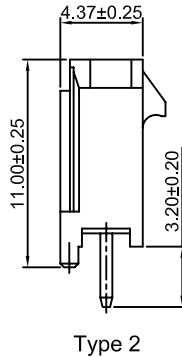
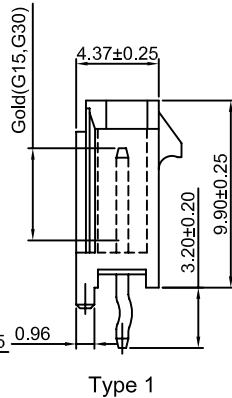
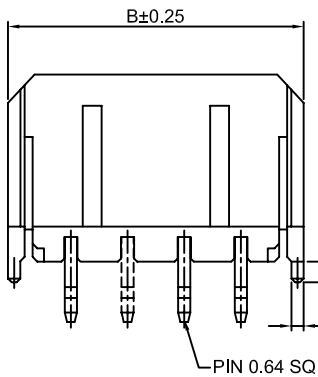

### Ordering Information & Dimensions:

PART NO.	Dimensions	
	A	B
2P	3.00	9.65
3P	6.00	12.65
4P	9.00	15.65
5P	12.00	18.65
6P	15.00	21.65
7P	18.00	24.65
8P	21.00	27.65
9P	24.00	30.65
10P	27.00	33.65
11P	30.00	36.65
12P	33.00	39.65

Unit: mm

## C3030WR-XP

3.00mm pitch 90° Single Row Wafer

### Reference Informations:

- \*Material:Pin:Brass/Tin over Nickel  
Insulator:Nylon 66,UL94V-0
- \*Mates with CJT C3030HF-XP series Housing
- \*Color:Black

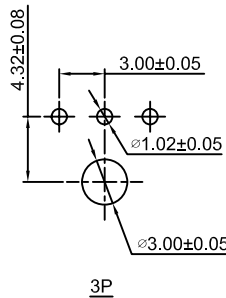
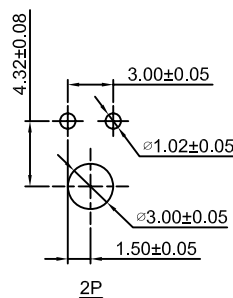
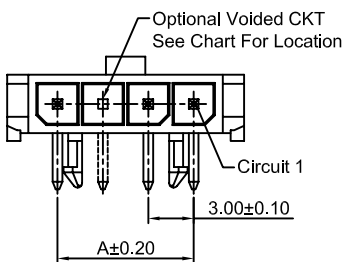

P.C.B LAYOUT

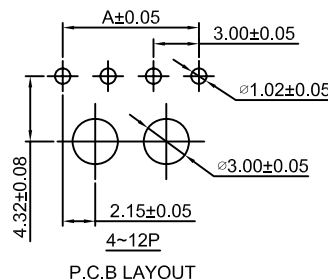
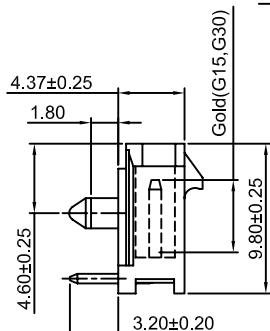
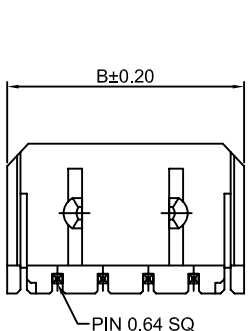

- Ordering Information:  
C3030WR-XP - \*\*\* - \*\*  
1 2 3
- 1.Part No.
  - 2.Material:  
(blank):Nylon66, UL94V-0  
LCP:LCP,UL94V-0  
GWT:LCP,UL94V-0,GWT 750°C
  - 3.Finish  
(blank):Tin over Nickel  
G:Gold-flash  
G15:15µin (0.38µm) MIN.Select Gold  
100µin (2.54µm) MIN.Select Tin  
G30:30µin (0.76µm) MIN.Select Gold  
100µin (2.54µm) MIN.Select Tin

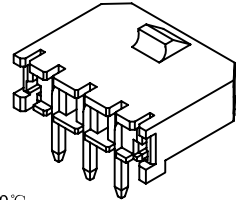

### Ordering Information & Dimensions:

PART NO.	Dimensions	
	A	B
2P	3.00	9.65
3P	6.00	12.65
4P	9.00	15.65
5P	12.00	18.65
6P	15.00	21.65
7P	18.00	24.65
8P	21.00	27.65
9P	24.00	30.65
10P	27.00	33.65
11P	30.00	36.65
12P	33.00	39.65

Unit: mm



# C3030 SERIES 3.00mm pitch wire to wire and wire to board connector

## C3030WV-S-XP

3.00mm pitch 180° Single Row Wafer-SMT TYPE

### Reference Informations:

- \*Material:Pin:Brass/Tin over Nickel  
Insulator:LCP,UL94V-0
- \*Mates with CJT C3030HF-XP series Housing
- \*Color:Black

### Ordering Information:

C3030WV-S-XP - \*\* - \*\*  
1 2 3

- 1.Part No.
- 2.Material:  
(blank):LCP, UL94V-0  
GWT:LCP, UL94V-0,GWT 750°C
- 3.Finish  
(blank): Tin over Nickel  
G:Gold-flash  
G15:15µin (0.38µm) MIN.Select Gold  
100µin (2.54µm) MIN.Select Tin  
G30:30µin (0.76µm) MIN.Select Gold  
100µin (2.54µm) MIN.Select Tin

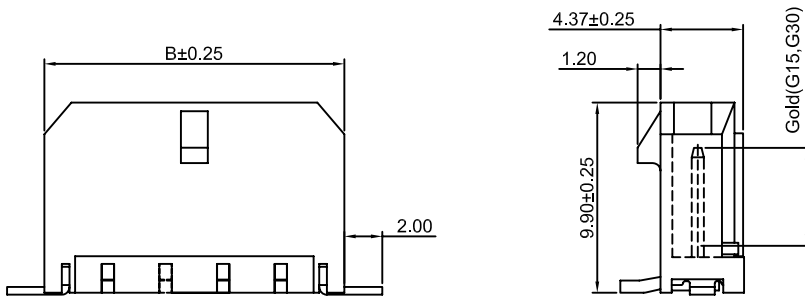
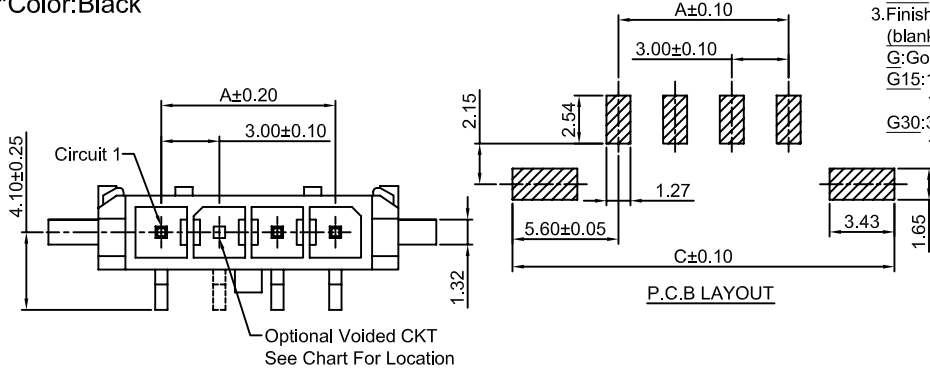
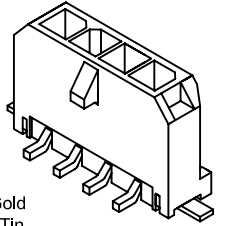

### Ordering Information & Dimensions:

PART NO.	Dimensions		
	A	B	C
2P	3.00	9.65	14.20
3P	6.00	12.65	17.20
4P	9.00	15.65	20.20
5P	12.00	18.65	23.20
6P	15.00	21.65	26.20
7P	18.00	24.65	29.20
8P	21.00	27.65	32.20
9P	24.00	30.65	35.20
10P	27.00	33.65	38.20
11P	30.00	36.65	41.20
12P	33.00	39.65	44.20

Unit: mm

## C3030WR-S-XP

3.00mm pitch 90° Single Row Wafer-SMT TYPE

### Reference Informations:

- \*Material:Pin:Brass/Tin over Nickel  
Insulator:LCP,UL94V-0
- \*Mates with CJT C3030HF-XP series Housing
- \*Color:Black

### Ordering Information:

C3030WR-S-XP - \*\*\* - \*\*  
1 2 3

- 1.Part No.
- 2.Material:  
(blank):LCP, UL94V-0  
GWT:LCP, UL94V-0,GWT 750°C
- 3.Finish  
(blank): Tin over Nickel  
G:Gold-flash  
G15:15µin (0.38µm) MIN.Select Gold  
100µin (2.54µm) MIN.Select Tin  
G30:30µin (0.76µm) MIN.Select Gold  
100µin (2.54µm) MIN.Select Tin

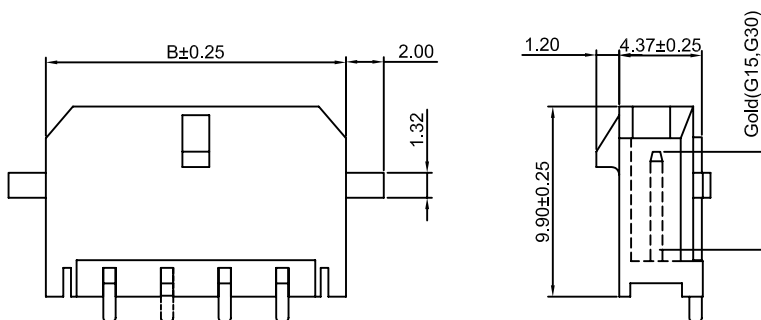
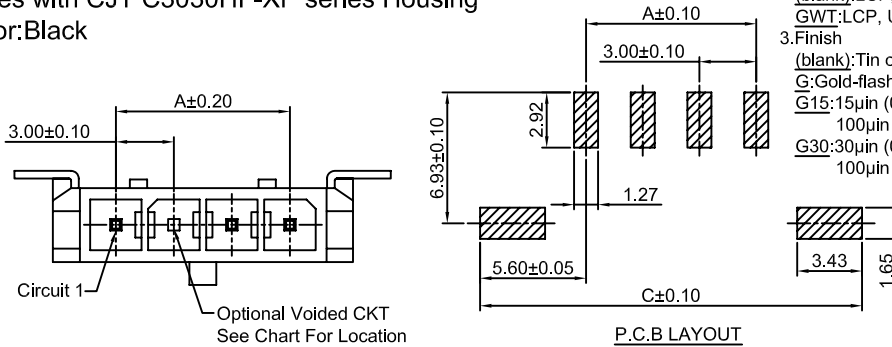
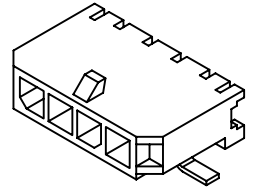

### Ordering Information & Dimensions:

PART NO.	Dimensions		
	A	B	C
2P	3.00	9.65	14.20
3P	6.00	12.65	17.20
4P	9.00	15.65	20.20
5P	12.00	18.65	23.20
6P	15.00	21.65	26.20
7P	18.00	24.65	29.20
8P	21.00	27.65	32.20
9P	24.00	30.65	35.20
10P	27.00	33.65	38.20
11P	30.00	36.65	41.20
12P	33.00	39.65	44.20

Unit: mm



# C3030 SERIES 3.00mm pitch wire to wire and wire to board connector

## C3030WV-F-XP

3.00mm pitch 180° Single Row Wafer

### Reference Informations:

- \*Material:Pin:Brass/Tin over Nickel  
Insulator:Nylon 66,UL94V-0
- \*Mates with CJT C3030HF-XP series Housing
- \*Color:Black

### Ordering Information:

C3030WV-F-XP - \*\*\* - \*\*  
1 2 3

- Part No.
- Material:  
(blank):Nylon 66, UL94V-0  
LCP:LCP,UL94V-0  
GWT:LCP, UL94V-0,GWT 750°C
- Finish  
(blank):Tin over Nickel  
G:Gold-flash  
G15:15µin (0.38µm) MIN.Select Gold  
100µin (2.54µm) MIN.Select Tin  
G30:30µin (0.76µm) MIN.Select Gold  
100µin (2.54µm) MIN.Select Tin

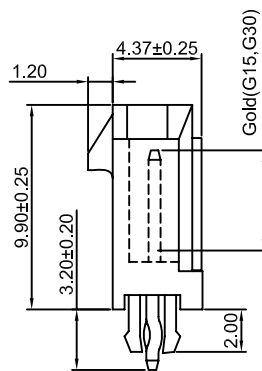
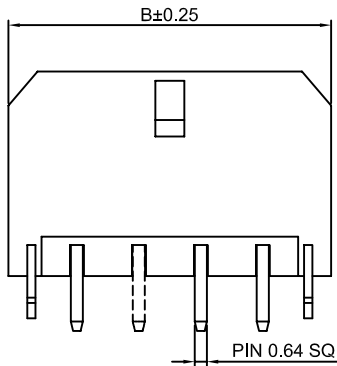
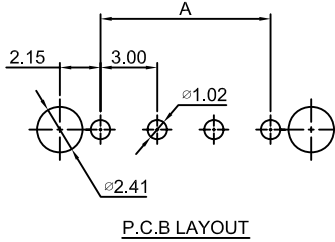
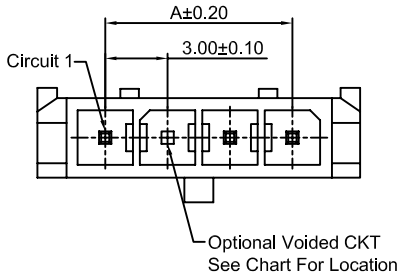

### Ordering Information & Dimensions:

PART NO.	Dimensions	
	A	B
2P	3.00	9.65
3P	6.00	12.65
4P	9.00	15.65
5P	12.00	18.65
6P	15.00	21.65
7P	18.00	24.65
8P	21.00	27.65
9P	24.00	30.65
10P	27.00	33.65
11P	30.00	36.65
12P	33.00	39.65

Unit: mm

## C3030WR-F-XP

3.00mm pitch 90° Single Row Wafer

### Reference Informations:

- \*Material:Pin:Brass/Tin over Nickel  
Insulator:Nylon 66,UL94V-0
- \*Mates with CJT C3030HF-XP series Housing
- \*Color:Black

### Ordering Information:

C3030WR-F-XP - \*\*\* - \*\*  
1 2 3

- Part No.
- Material:  
(blank):Nylon 66, UL94V-0  
LCP:LCP,UL94V-0  
GWT:LCP, UL94V-0,GWT 750°C
- Finish  
(blank):Tin over Nickel  
G:Gold-flash  
G15:15µin (0.38µm) MIN.Select Gold  
100µin (2.54µm) MIN.Select Tin  
G30:30µin (0.76µm) MIN.Select Gold  
100µin (2.54µm) MIN.Select Tin

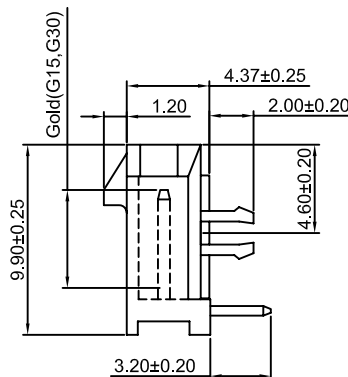
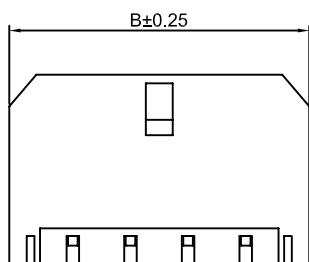
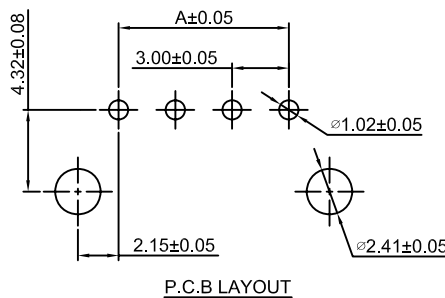
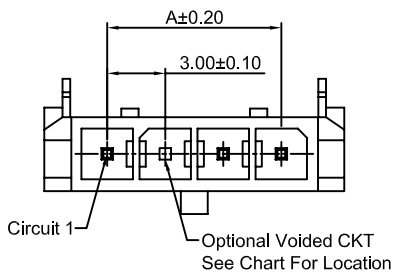

### Ordering Information & Dimensions:

PART NO.	Dimensions	
	A	B
2P	3.00	9.65
3P	6.00	12.65
4P	9.00	15.65
5P	12.00	18.65
6P	15.00	21.65
7P	18.00	24.65
8P	21.00	27.65
9P	24.00	30.65
10P	27.00	33.65
11P	30.00	36.65
12P	33.00	39.65

Unit: mm



# C3030 SERIES 3.00mm pitch wire to wire and wire to board connector

## C3030WV-S-F-XP

3.00mm pitch 180° Single Row Wafer-SMT TYPE

### Reference Informations:

- \*Material:Pin:Brass/Tin over Nickel  
Insulator:LCP,UL94V-0
- \*Mates with CJT C3030HF-XP series Housing
- \*Color:Black

### Ordering Information:

C3030WV-S-F-XP - \*\*\* - \*\*  
1 2 3

- Part No.
- Material:  
(blank):LCP, UL94V-0  
GWT:LCP, UL94V-0,GWT 750°C
- Finish  
(blank):Tin over Nickel  
G:Gold-flash  
G15:15µin (0.38µm) MIN.Select Gold  
100µin (2.54µm) MIN.Select Tin  
G30:30µin (0.76µm) MIN.Select Gold  
100µin (2.54µm) MIN.Select Tin

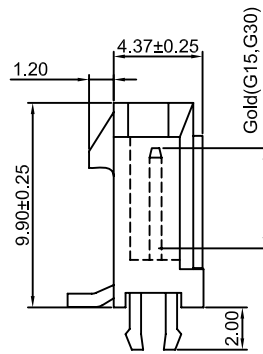
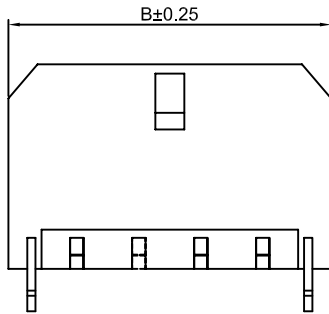
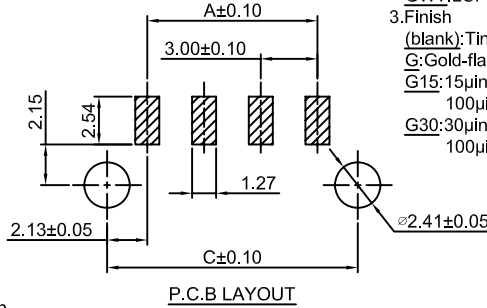
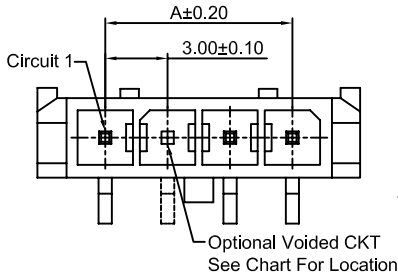
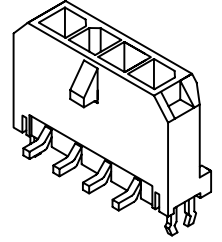

### Ordering Information & Dimensions:

PART NO.	Dimensions		
	A	B	C
2P	3.00	9.65	7.30
3P	6.00	12.65	10.30
4P	9.00	15.65	13.30
5P	12.00	18.65	16.30
6P	15.00	21.65	19.30
7P	18.00	24.65	22.30
8P	21.00	27.65	25.30
9P	24.00	30.65	28.30
10P	27.00	33.65	31.30
11P	30.00	36.65	34.30
12P	33.00	39.65	37.30

Unit: mm

## C3030WR-S-F-XP

3.00mm pitch 90° Single Row Wafer-SMT TYPE

### Reference Informations:

- \*Material:Pin:Brass/Tin over Nickel  
Insulator:LCP,UL94V-0
- \*Mates with CJT C3030HF-XP series Housing
- \*Color:Black

### Ordering Information:

C3030WR-S-F-XP - \*\*\* - \*\*  
1 2 3

- Part No.
- Material:  
(blank):LCP, UL94V-0  
GWT:LCP, UL94V-0,GWT 750°C
- Finish  
(blank):Tin over Nickel  
G:Gold-flash  
G15:15µin (0.38µm) MIN.Select Gold  
100µin (2.54µm) MIN.Select Tin  
G30:30µin (0.76µm) MIN.Select Gold  
100µin (2.54µm) MIN.Select Tin

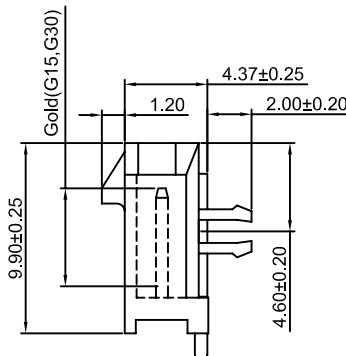
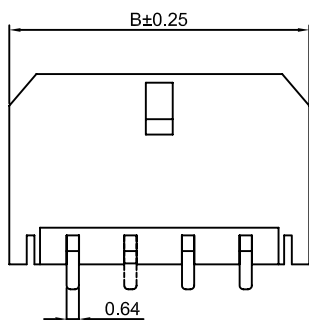
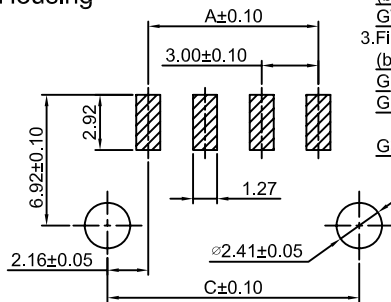
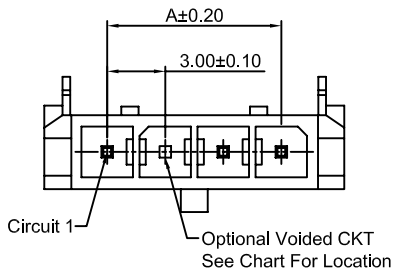
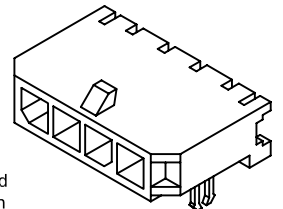

### Ordering Information & Dimensions:

PART NO.	Dimensions		
	A	B	C
2P	3.00	9.65	7.30
3P	6.00	12.65	10.30
4P	9.00	15.65	13.30
5P	12.00	18.65	16.30
6P	15.00	21.65	19.30
7P	18.00	24.65	22.30
8P	21.00	27.65	25.30
9P	24.00	30.65	28.30
10P	27.00	33.65	31.30
11P	30.00	36.65	34.30
12P	33.00	39.65	37.30

Unit: mm



# C3030 SERIES 3.00mm pitch wire to wire and wire to board connector

## C3030WV-2xXP

3.00mm pitch 180° Dual Row Wafer

### Reference Informations:

- \*Material: Pin: Brass/Tin over Nickel  
Insulator: Nylon 66, UL94V-0
- \*Mates with CJT C3030HF-2xXP series Housing
- \*Color: Black

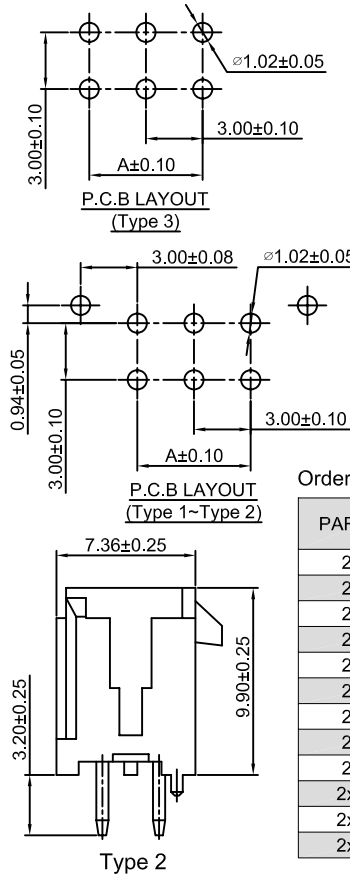
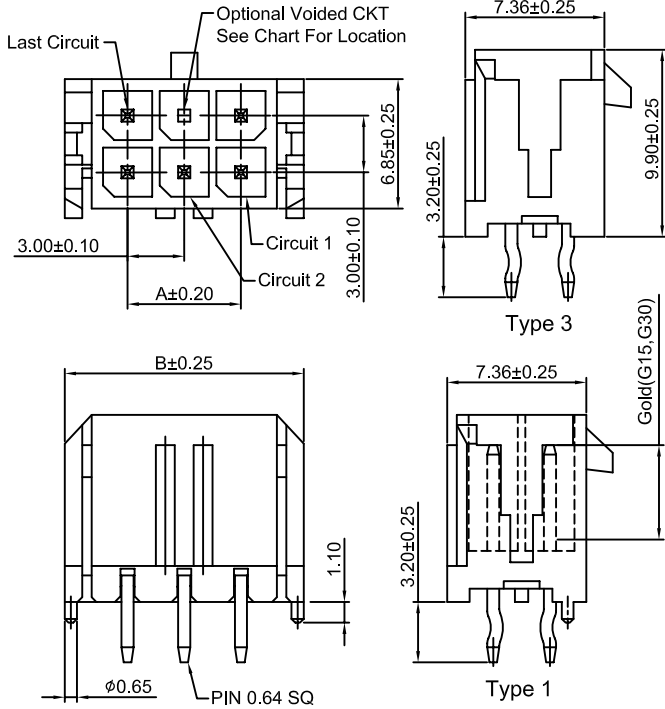

### Ordering Information:

C3030WV-2xXP - \* - \*\*\* - \*\*\*  
1 2 3 4

- Part No.
- Style:  
(blank) : Type 1  
2 : Type 2
- Material:  
(blank) : Nylon 66, UL94V-0  
LCP: LCP, UL94V-0  
GWT: LCP, UL94V-0, GWT 750°C
- Finish  
(blank) : Tin over Nickel  
G: Gold-flash  
G15: 15µin (0.38µm) MIN. Select Gold  
100µin (2.54µm) MIN. Select Tin  
G30: 30µin (0.76µm) MIN. Select Gold  
100µin (2.54µm) MIN. Select Tin

### Ordering Information & Dimensions:

PART NO.	Dimensions	
	A	B
2x1P	----	6.65
2x2P	3.00	9.65
2x3P	6.00	12.65
2x4P	9.00	15.65
2x5P	12.00	18.65
2x6P	15.00	21.65
2x7P	18.00	24.65
2x8P	21.00	27.65
2x9P	24.00	30.65
2x10P	27.00	33.65
2x11P	30.00	36.65
2x12P	33.00	39.65

Unit: mm

## C3030WR-2xXP

3.00mm pitch 90° Dual Row Wafer With Foot

### Reference Informations:

- \*Material: Pin: Brass/Tin over Nickel  
Insulator: Nylon 66, UL94V-0
- \*Mates with CJT C3030HF-2xXP series Housing
- \*Color: Black

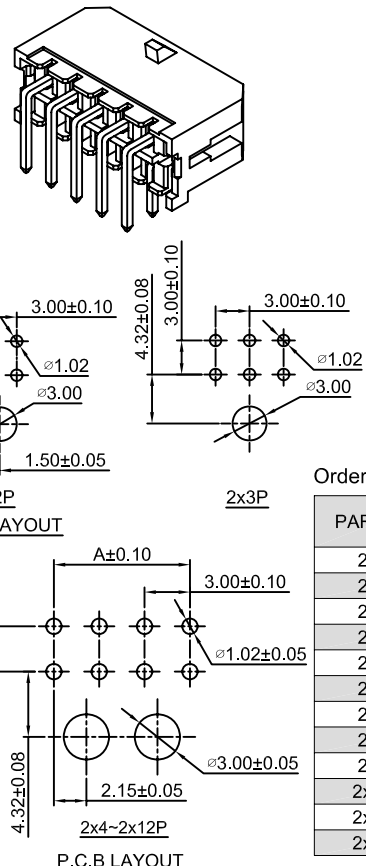
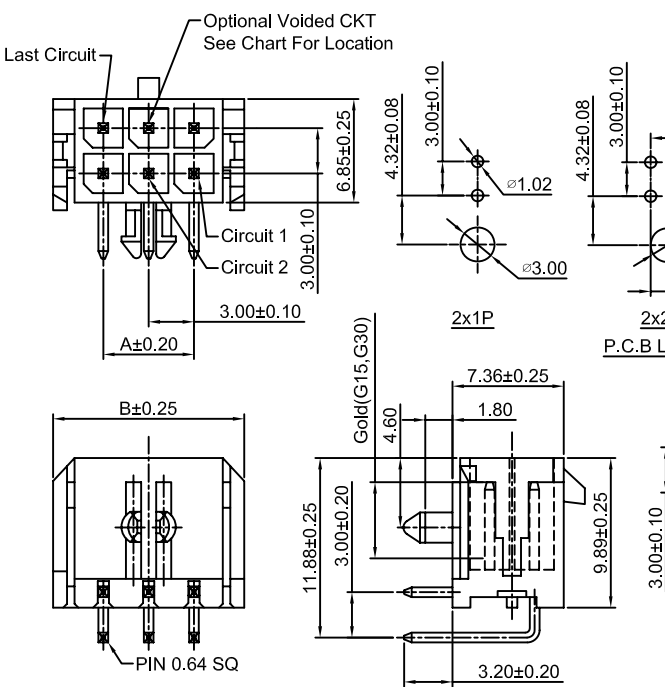

### Ordering Information:

C3030WR-2xXP - \*\*\* - \*\*\*  
1 2 3

- Part No.
- Material:  
(blank) : Nylon 66, UL94V-0  
LCP: LCP, UL94V-0  
GWT: LCP, UL94V-0, GWT 750°C
- Finish  
(blank) : Tin over Nickel  
G: Gold-flash  
G15: 15µin (0.38µm) MIN. Select Gold  
100µin (2.54µm) MIN. Select Tin  
G30: 30µin (0.76µm) MIN. Select Gold  
100µin (2.54µm) MIN. Select Tin

### Ordering Information & Dimensions:

PART NO.	Dimensions	
	A	B
2x1P	----	6.85
2x2P	3.00	9.85
2x3P	6.00	12.85
2x4P	9.00	15.85
2x5P	12.00	18.85
2x6P	15.00	21.85
2x7P	18.00	24.85
2x8P	21.00	27.85
2x9P	24.00	30.85
2x10P	27.00	33.85
2x11P	30.00	36.85
2x12P	33.00	39.85

Unit: mm





# C3030 SERIES 3.00mm pitch wire to wire and wire to board connector

## C3030WV-S-2xXP

3.00mm pitch 180° Dual Row Wafer-SMT TYPE

### Reference Informations:

- \*Material: Pin: Brass/Tin over Nickel  
Insulator: LCP, UL94V-0
- \*Mates with CJT C3030HF-2xXP series Housing
- \*Color: Black

Ordering Information:  
C3030WV-S-2xXP - \*\*\* - \*\*\*  
1 2 3

- Part No.
- Material:  
(blank): LCP UL94V-0  
GWT: LCP UL94V-0, GWT 750°C
- Finish  
(blank): Tin over Nickel  
G: Gold-flash  
G15: 15µin (0.38µm) MIN. Select Gold  
100µin (2.54µm) MIN. Select Tin  
G30: 30µin (0.76µm) MIN. Select Gold  
100µin (2.54µm) MIN. Select Tin

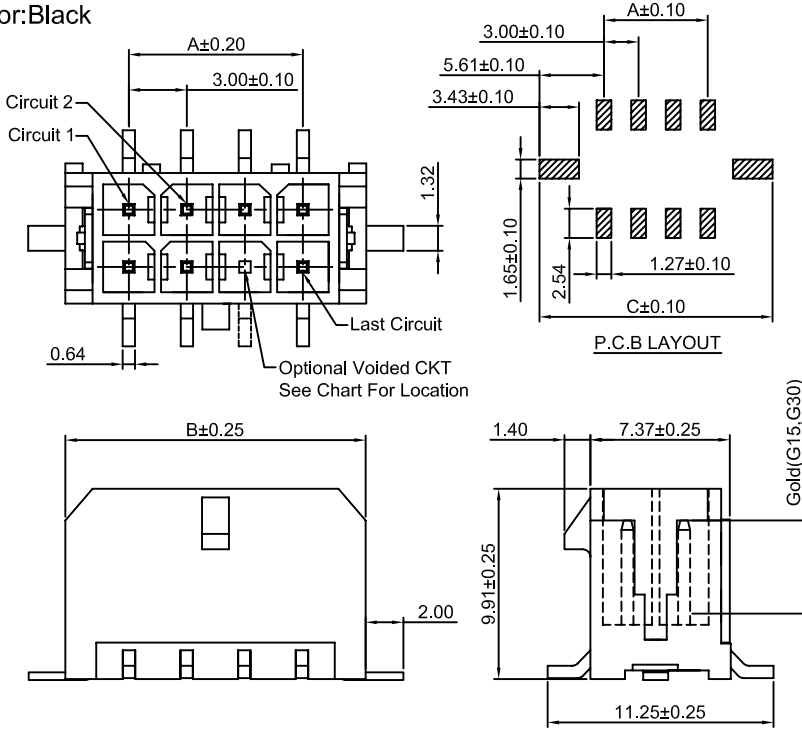
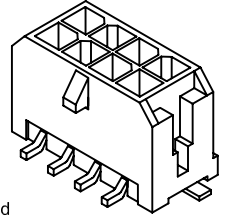

### Ordering Information & Dimensions:

PART NO.	Dimensions		
	A	B	C
2x1P	----	6.65	11.20
2x2P	3.00	9.65	14.20
2x3P	6.00	12.65	17.20
2x4P	9.00	15.65	20.20
2x5P	12.00	18.65	23.20
2x6P	15.00	21.65	26.20
2x7P	18.00	24.65	29.20
2x8P	21.00	27.65	32.20
2x9P	24.00	30.65	35.20
2x10P	27.00	33.65	38.20
2x11P	30.00	36.65	41.20
2x12P	33.00	39.65	44.20

Unit: mm

## C3030WR-S-2xXP

3.00mm pitch 90° Dual Row Wafer-SMT TYPE

### Reference Informations:

- \*Material: Pin: Brass/Tin over Nickel  
Insulator: LCP, UL94V-0
- \*Mates with CJT C3030HF-2xXP series Housing
- \*Color: Black

Ordering Information:  
C3030WR-S-2xXP - \*\*\* - \*\*\*  
1 2 3

- Part No.
- Material:  
(blank): LCP, UL94V-0  
GWT: LCP, UL94V-0, GWT 750°C
- Finish  
(blank): Tin over Nickel  
G: Gold-flash  
G15: 15µin (0.38µm) MIN. Select Gold  
100µin (2.54µm) MIN. Select Tin  
G30: 30µin (0.76µm) MIN. Select Gold  
100µin (2.54µm) MIN. Select Tin

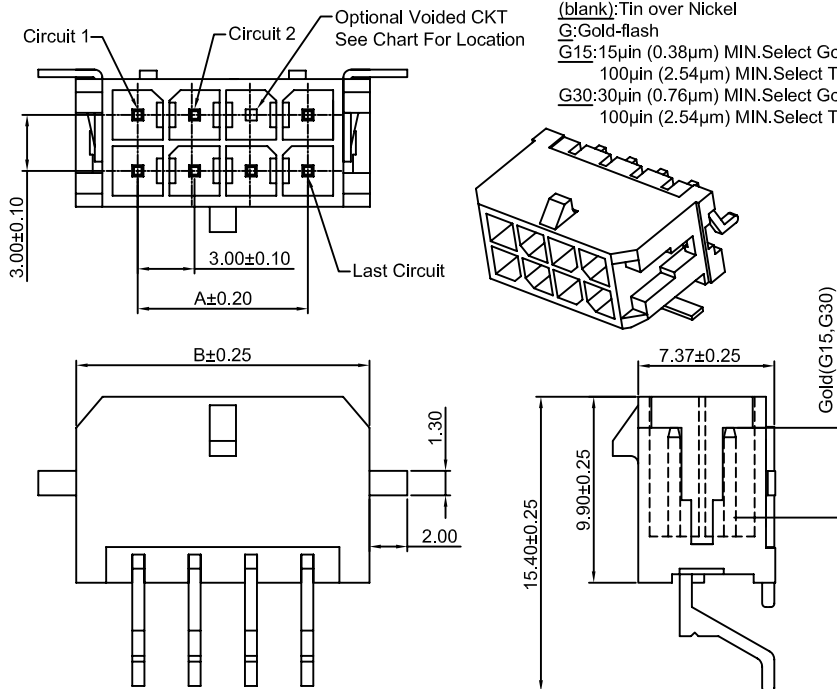

### Ordering Information & Dimensions:

PART NO.	Dimensions		
	A	B	C
2x1P	----	6.65	11.20
2x2P	3.00	9.65	14.20
2x3P	6.00	12.65	17.20
2x4P	9.00	15.65	20.20
2x5P	12.00	18.65	23.20
2x6P	15.00	21.65	26.20
2x7P	18.00	24.65	29.20
2x8P	21.00	27.65	32.20
2x9P	24.00	30.65	35.20
2x10P	27.00	33.65	38.20
2x11P	30.00	36.65	41.20
2x12P	33.00	39.65	44.20

Unit: mm





# C3030 SERIES 3.00mm pitch wire to wire and wire to board connector

## C3030WV-F-2xXP

3.00mm pitch 180° Dual Row Wafer

### Reference Informations:

- \*Material: Pin: Brass/Tin over Nickel  
Insulator: Nylon 66, UL94V-0
- \*Mates with CJT C3030HF-2xXP series Housing
- \*Color: Black

Ordering Information:  
C3030WV-F-2xXP - \*\*\* - \*\*\*  
1 2 3

- Part No.
- Material:  
(blank): Nylon66, UL94V-0  
LCP: LCP, UL94V-0  
GWT: LCP, UL94V-0, GWT 750°C
- Finish  
(blank): Tin over Nickel  
G: Gold-flash  
G15: 15µm (0.38µm) MIN. Select Gold  
100µm (2.54µm) MIN. Select Tin  
G30: 30µm (0.76µm) MIN. Select Gold  
100µm (2.54µm) MIN. Select Tin

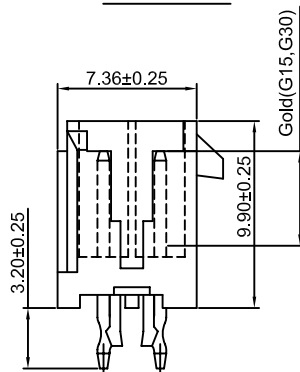
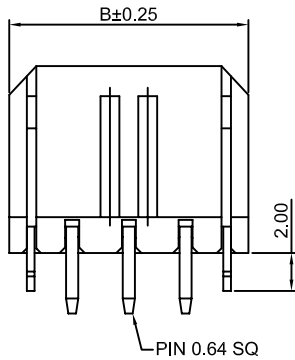
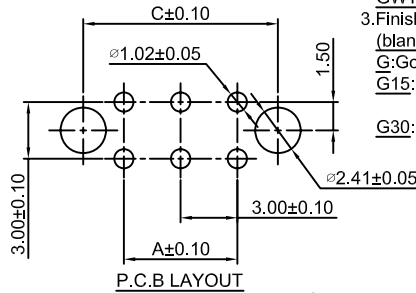
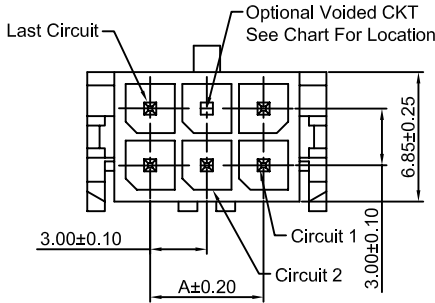
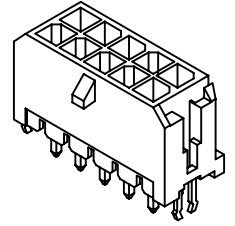

### Ordering Information & Dimensions:

PART NO.	Dimensions		
	A	B	C
2x1P	----	6.65	4.30
2x2P	3.00	9.65	7.30
2x3P	6.00	12.65	10.30
2x4P	9.00	15.65	13.30
2x5P	12.00	18.65	16.30
2x6P	15.00	21.65	19.30
2x7P	18.00	24.65	22.30
2x8P	21.00	27.65	25.30
2x9P	24.00	30.65	28.30
2x10P	27.00	33.65	31.30
2x11P	30.00	36.65	34.30
2x12P	33.00	39.65	37.30

Unit: mm

## C3030WR-F-2xXP

3.00mm pitch 90° Dual Row Wafer With Foot

### Reference Informations:

- \*Material: Pin: Brass/Tin over Nickel  
Insulator: Nylon 66, UL94V-0
- \*Mates with CJT C3030HF-2xXP series Housing
- \*Color: Black

Ordering Information:  
C3030WR-F-2xXP - \*\*\* - \*\*\*  
1 2 3

- Part No.
- Material:  
(blank): Nylon66, UL94V-0  
LCP: LCP, UL94V-0  
GWT: LCP, UL94V-0, GWT 750°C
- Finish  
(blank): Tin over Nickel  
G: Gold-flash  
G15: 15µm (0.38µm) MIN. Select Gold  
100µm (2.54µm) MIN. Select Tin  
G30: 30µm (0.76µm) MIN. Select Gold  
100µm (2.54µm) MIN. Select Tin

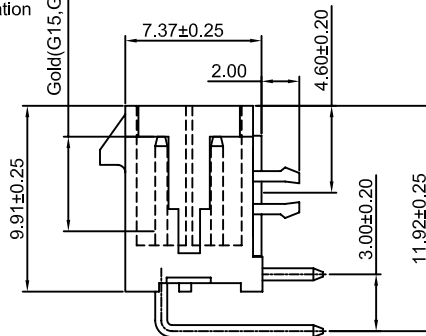
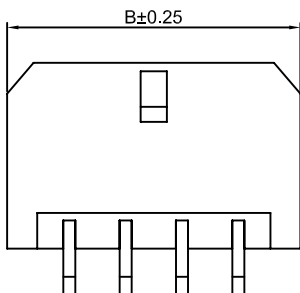
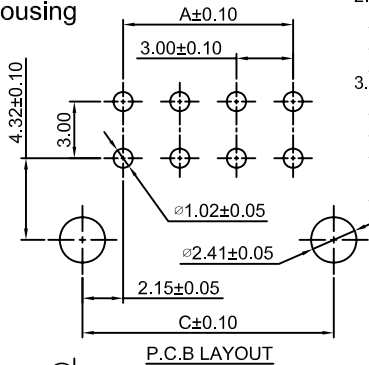
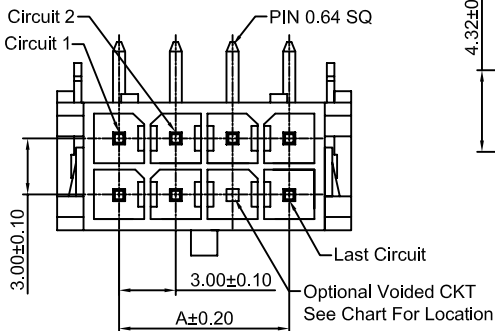
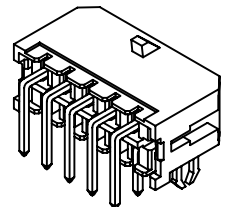

### Ordering Information & Dimensions:

PART NO.	Dimensions		
	A	B	C
2x1P	----	6.65	4.30
2x2P	3.00	9.65	7.30
2x3P	6.00	12.65	10.30
2x4P	9.00	15.65	13.30
2x5P	12.00	18.65	16.30
2x6P	15.00	21.65	19.30
2x7P	18.00	24.65	22.30
2x8P	21.00	27.65	25.30
2x9P	24.00	30.65	28.30
2x10P	27.00	33.65	31.30
2x11P	30.00	36.65	34.30
2x12P	33.00	39.65	37.30

Unit: mm



# C3030 SERIES 3.00mm pitch wire to wire and wire to board connector

## C3030WV-S-F-2xXP

3.00mm pitch 180° Dual Row Wafer-SMT TYPE

### Reference Informations:

- \*Material: Pin: Brass/Tin over Nickel  
Insulator: LCP, UL94V-0
- \*Mates with CJT C3030HF-2xXP series Housing
- \*Color: Black

### Ordering Information:

C3030WV-S-F-2xXP - \*\*\* - \*\*\*  
1 2 3

- Part No.
- Material:  
(blank): LCP, UL94V-0  
GWT: LCP, UL94V-0, GWT 750°C
- Finish  
(blank): Tin over Nickel  
G: Gold-flash  
G15: 15µin (0.38µm) MIN. Select Gold  
100µin (2.54µm) MIN. Select Tin  
G30: 30µin (0.76µm) MIN. Select Gold  
100µin (2.54µm) MIN. Select Tin

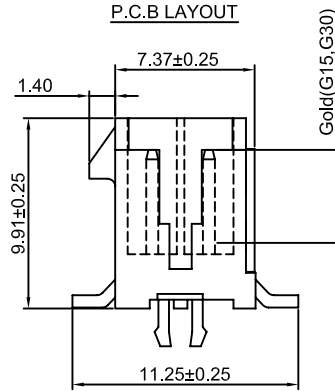
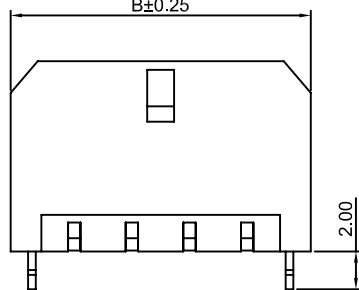
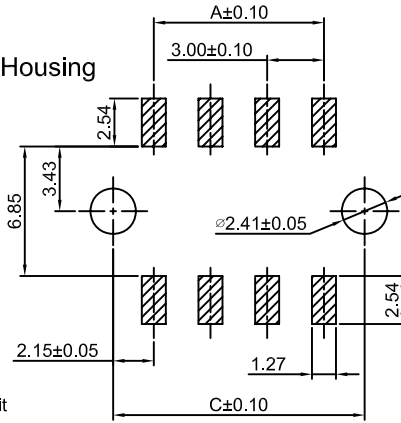
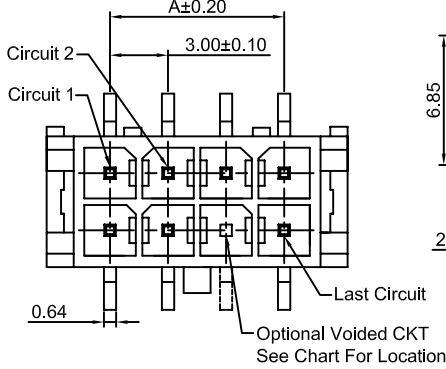
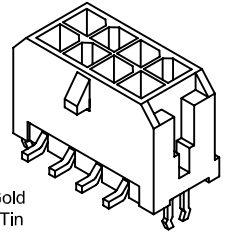

### Ordering Information & Dimensions:

PART NO.	Dimensions		
	A	B	C
2x1P	----	6.65	4.30
2x2P	3.00	9.65	7.30
2x3P	6.00	12.65	10.30
2x4P	9.00	15.65	13.30
2x5P	12.00	18.65	16.30
2x6P	15.00	21.65	19.30
2x7P	18.00	24.65	22.30
2x8P	21.00	27.65	25.30
2x9P	24.00	30.65	28.30
2x10P	27.00	33.65	31.30
2x11P	30.00	36.65	34.30
2x12P	33.00	39.65	37.30

Unit: mm

## C3030WR-S-F-2xXP

3.00mm pitch 90° Dual Row Wafer-SMT TYPE

### Reference Informations:

- \*Material: Pin: Brass/Tin over Nickel  
Insulator: LCP, UL94V-0
- \*Mates with CJT C3030HF-2xXP series Housing
- \*Color: Black

### Ordering Information:

C3030WR-S-F-2xXP - \*\*\* - \*\*\*  
1 2 3

- Part No.
- Material:  
(blank): LCP, UL94V-0  
GWT: LCP, UL94V-0, GWT 750°C
- Finish  
(blank): Tin over Nickel  
G: Gold-flash  
G15: 15µin (0.38µm) MIN. Select Gold  
100µin (2.54µm) MIN. Select Tin  
G30: 30µin (0.76µm) MIN. Select Gold  
100µin (2.54µm) MIN. Select Tin

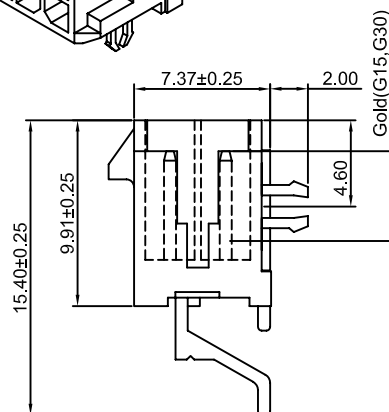
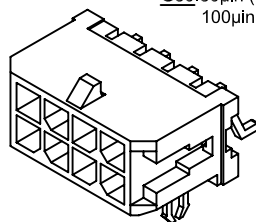
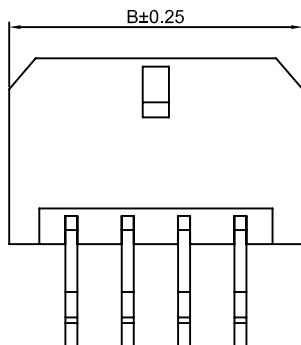
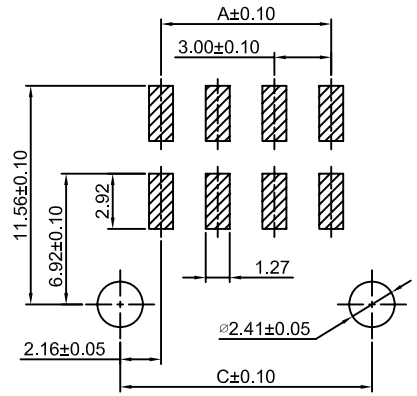
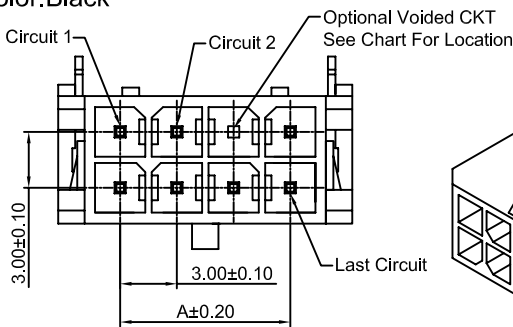

### Ordering Information & Dimensions:

PART NO.	Dimensions		
	A	B	C
2x1P	----	6.65	4.30
2x2P	3.00	9.65	7.30
2x3P	6.00	12.65	10.30
2x4P	9.00	15.65	13.30
2x5P	12.00	18.65	16.30
2x6P	15.00	21.65	19.30
2x7P	18.00	24.65	22.30
2x8P	21.00	27.65	25.30
2x9P	24.00	30.65	28.30
2x10P	27.00	33.65	31.30
2x11P	30.00	36.65	34.30
2x12P	33.00	39.65	37.30

Unit: mm



# C3030 SERIES 3.00mm pitch wire to wire and wire to board connector

## C3030WVA-2xXP

3.00mm pitch 180° Dual Row Wafer

### Reference Informations:

- \*Material: Pin: Brass/Tin over Nickel  
Insulator: Nylon 46, UL94V-0
- \*Mates with CJT C3030HF series dual row Housing
- \*Color: Black

### Ordering Information:

C3030WVA--2xXP - \* - \*\*\* - \*\*\*  
1 2 3 4

- Part No.
- Style:  
(blank): Type 1  
3: Type 3
- Material:  
(blank): Nylon 46, UL94V-0  
GWT: Nylon 46, UL94V-0, GWT 750°C
- Finish:  
(blank): Tin over Nickel  
G: Gold-flash  
G15: 15µin (0.38µm) MIN. Select Gold  
100µin (2.54µm) MIN. Select Tin  
G30: 30µin (0.76µm) MIN. Select Gold  
100µin (2.54µm) MIN. Select Tin

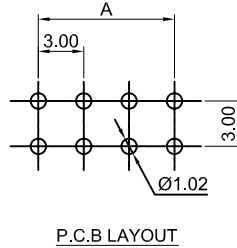
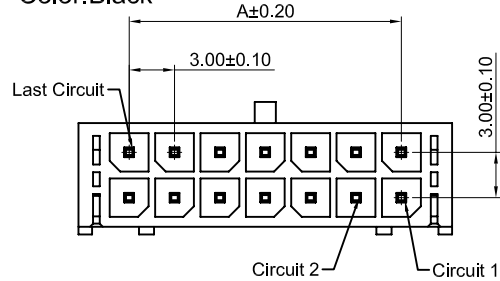
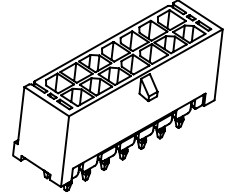

### Ordering Information & Dimensions:

PART NO.	Dimensions	
	A	B
2x1P	----	6.70
2x2P	3.00	9.70
2x3P	6.00	12.70
2x4P	9.00	15.70
2x5P	12.00	18.70
2x6P	15.00	21.70
2x7P	18.00	24.70
2x8P	21.00	27.70
2x9P	24.00	30.70
2x10P	27.00	33.70
2x11P	30.00	36.70
2x12P	33.00	39.70

Unit: mm

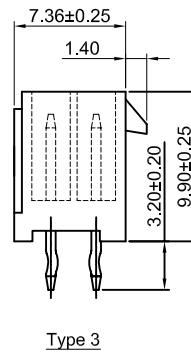
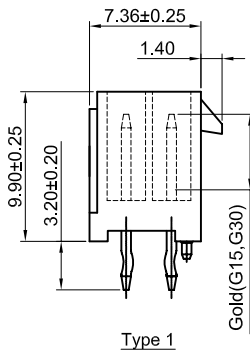
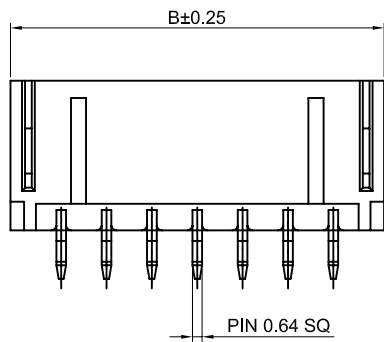

## C3030WVA-S-2xXP

3.00mm pitch 180° Dual Row Wafer - SMT TYPE

### Reference Informations:

- \*Material: Pin: Brass/Tin over Nickel  
Insulator: Nylon 46, UL94V-0
- \*Mates with CJT C3030HF series dual row Housing
- \*Color: Black

### Ordering Information:

C3030WVA-S-2xXP - \*\*\* - \*\*  
1 2 3

- Part No.
- Material:  
(blank): Nylon 46, UL94V-0  
GWT: Nylon 46, UL94V-0, GWT 750°C
- Finish:  
(blank): Tin over Nickel  
G: Gold-flash  
G15: 15µin (0.38µm) MIN. Select Gold  
100µin (2.54µm) MIN. Select Tin  
G30: 30µin (0.76µm) MIN. Select Gold  
100µin (2.54µm) MIN. Select Tin

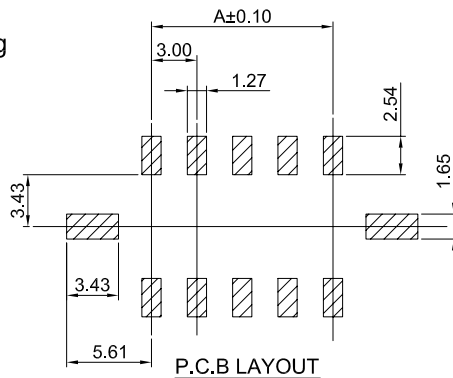
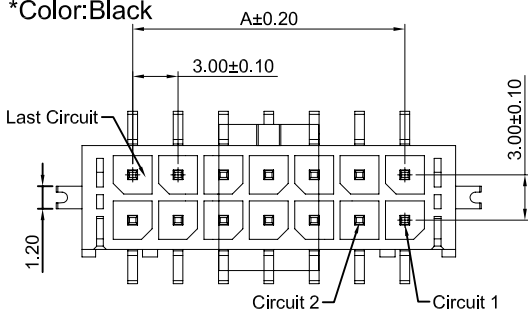

### Ordering Information & Dimensions:

PART NO.	Dimensions		
	A	B	C
2x1P	----	6.70	6.60
2x2P	3.00	9.70	6.60
2x3P	6.00	12.70	6.60
2x4P	9.00	15.70	6.60
2x5P	12.00	18.70	6.60
2x6P	15.00	21.70	6.60
2x7P	18.00	24.70	6.60
2x8P	21.00	27.70	12.00
2x9P	24.00	30.70	12.00
2x10P	27.00	33.70	12.00
2x11P	30.00	36.70	12.00
2x12P	33.00	39.70	12.00

Unit: mm

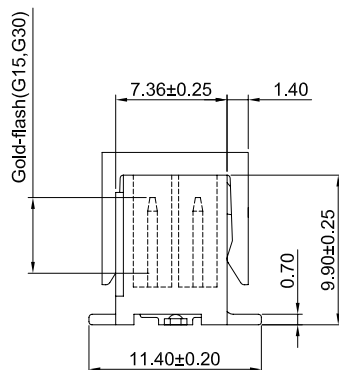
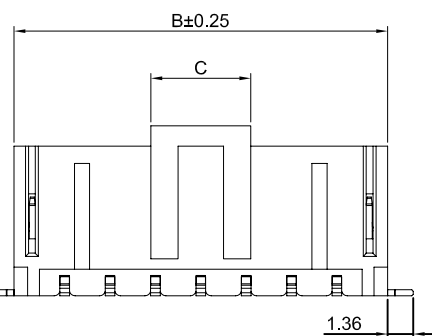



# C3030 SERIES 3.00mm pitch wire to wire and wire to board connector

## C3030WRA-F-2xXP

3.00mm pitch 90° Dual Row Wafer

### Reference Informations:

- \*Material: Pin: Brass/Tin over Nickel  
Insulator: Nylon 46, UL94V-0
- \*Mates with CJT C3030HF series dual row Housing
- \*Color: Black

Ordering Information:  
C3030WRA-F-2xXP - \*\*\* - \*\*  
1 2 3

1. Part No.
2. Material:  
(blank): Nylon 46, UL94V-0  
GWT: Nylon 46, UL94V-0, GWT 750°C
3. Finish  
(blank): Tin over Nickel  
G: Gold-flash  
G15: 15µm (0.38µm) MIN. Select Gold  
100µm (2.54µm) MIN. Select Tin  
G30: 30µm (0.76µm) MIN. Select Gold  
100µm (2.54µm) MIN. Select Tin

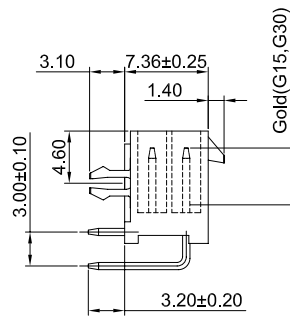
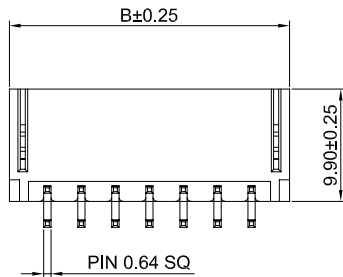
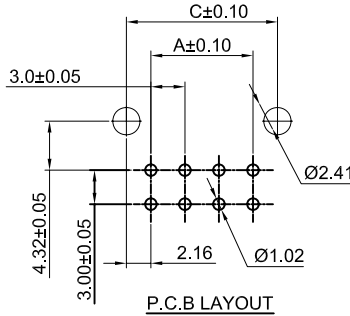
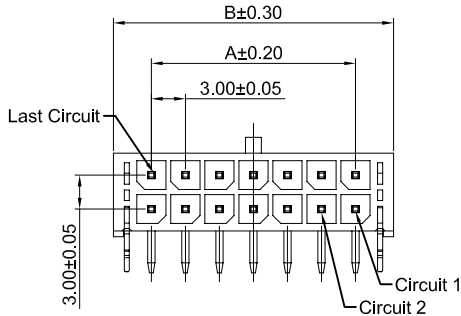

### Ordering Information & Dimensions:

PART NO.	Dimensions		
	A	B	C
2x1P	----	6.65	4.30
2x2P	3.00	9.65	7.30
2x3P	6.00	12.65	10.30
2x4P	9.00	15.65	13.30
2x5P	12.00	18.65	16.30
2x6P	15.00	21.65	19.30
2x7P	18.00	24.65	22.30
2x8P	21.00	27.65	25.30
2x9P	24.00	30.65	28.30
2x10P	27.00	33.65	31.30
2x11P	30.00	36.65	34.30
2x12P	33.00	39.65	37.30

Unit: mm

## C3030WRA-F1-2xXP

3.00mm pitch 90° Dual Row Wafer

### Reference Informations:

- \*Material: Pin: Brass/Tin over Nickel  
Insulator: Nylon 46, UL94V-0
- \*Mates with CJT C3030HF series dual row Housing
- \*Color: Black

Ordering Information:  
C3030WRA-F1-2xXP - \*\*\* - \*\*  
1 2 3

1. Part No.
2. Material:  
(blank): Nylon 46, UL94V-0  
GWT: Nylon 46, UL94V-0, GWT 750°C
3. Finish  
(blank): Tin over Nickel  
G: Gold-flash  
G15: 15µm (0.38µm) MIN. Select Gold  
100µm (2.54µm) MIN. Select Tin  
G30: 30µm (0.76µm) MIN. Select Gold  
100µm (2.54µm) MIN. Select Tin

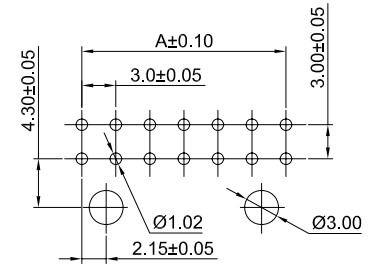
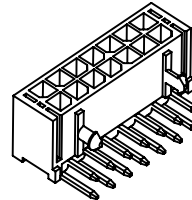
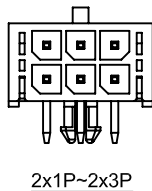
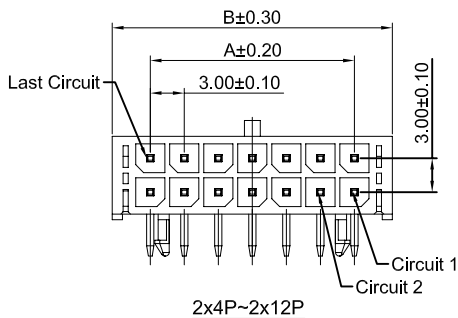

P.C.B LAYOUT  
2x4P~2x12P

### Ordering Information & Dimensions:

PART NO.	Dimensions		
	A	B	C
2x1P	----	6.65	2.90
2x2P	3.00	9.65	2.90
2x3P	6.00	12.65	2.90
2x4P	9.00	15.65	7.60
2x5P	12.00	18.65	10.60
2x6P	15.00	21.65	13.60
2x7P	18.00	24.65	16.60
2x8P	21.00	27.65	19.60
2x9P	24.00	30.65	22.60
2x10P	27.00	33.65	25.60
2x11P	30.00	36.65	28.60
2x12P	33.00	39.65	31.60

Unit: mm

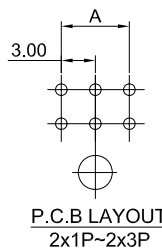
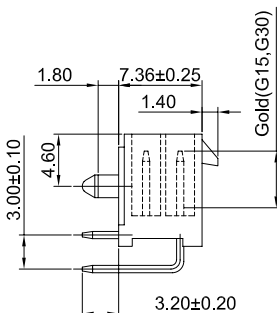
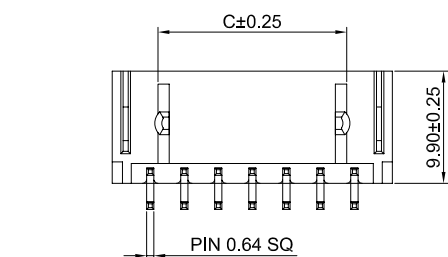

P.C.B LAYOUT  
2x1P~2x3P



# C3030 SERIES 3.00mm pitch wire to wire and wire to board connector

## C3030WRA-S-2xXP

3.00mm pitch 90° Dual Row Wafer - SMT TYPE

### Reference Informations:

- \*Material:Pin:Brass/Tin over Nickel  
Insulator:LCP,UL94V-0
- \*Mates with CJT C3030HF-2xXP series Housing
- \*Color:Black

Ordering Information:  
C3030WRA-S-2xXP - \*\*\* - \*\*\*  
1 2 3

- Part No.
- Material:  
(blank):LCP,UL94V-0  
GWT:LCP,UL94V-0,GWT 750°C
- Finish  
(blank):Tin over Nickel  
G:Gold-flash  
G15:15µin (0.38µm) MIN.Select Gold  
100µin (2.54µm) MIN.Select Tin  
G30:30µin (0.76µm) MIN.Select Gold  
100µin (2.54µm) MIN.Select Tin

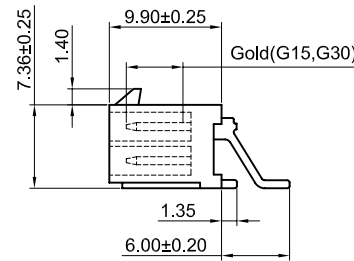
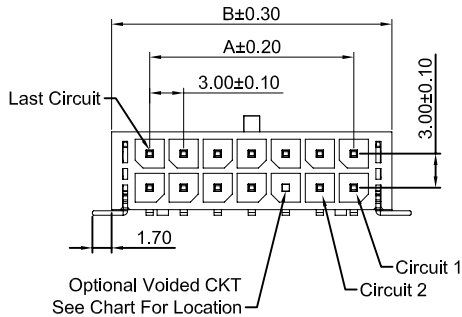
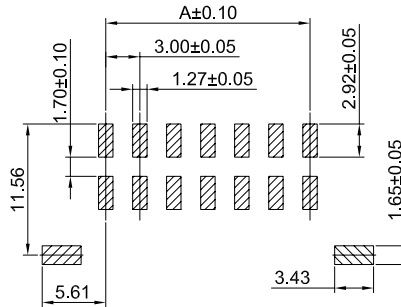
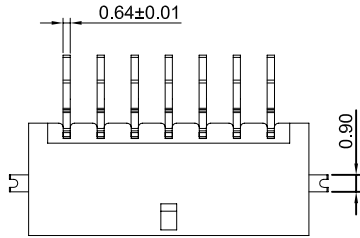

### Ordering Information & Dimensions:

PART NO.	Dimensions	
	A	B
2x1P	----	6.70
2x2P	3.00	9.70
2x3P	6.00	12.70
2x4P	9.00	15.70
2x5P	12.00	18.70
2x6P	15.00	21.70
2x7P	18.00	24.70
2x8P	21.00	27.70
2x9P	24.00	30.70
2x10P	27.00	33.70
2x11P	30.00	36.70
2x12P	33.00	39.70

Unit: mm

## C3030WRA-S-F-2xXP

3.00mm pitch 90° Dual Row Wafer - SMT TYPE

### Reference Informations:

- \*Material:Pin:Brass/Tin over Nickel  
Insulator:LCP,UL94V-0
- \*Mates with CJT C3030HF-2xXP series Housing
- \*Color:Black

Ordering Information:  
C3030WRA-S-F-2xXP - \*\*\* - \*\*\*  
1 2 3

- Part No.
- Material:  
(blank):LCP,UL94V-0  
GWT:LCP,UL94V-0,GWT 750°C
- Finish  
(blank):Tin over Nickel  
G:Gold-flash  
G15:15µin (0.38µm) MIN.Select Gold  
100µin (2.54µm) MIN.Select Tin  
G30:30µin (0.76µm) MIN.Select Gold  
100µin (2.54µm) MIN.Select Tin

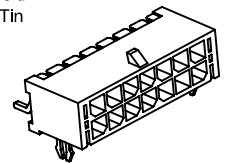
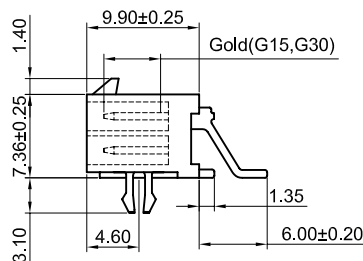
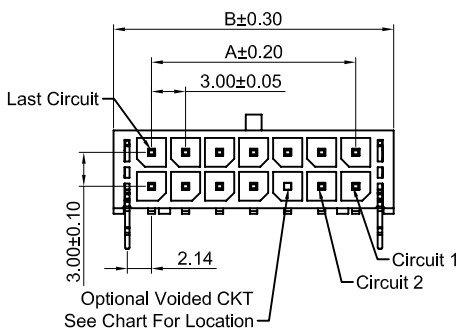
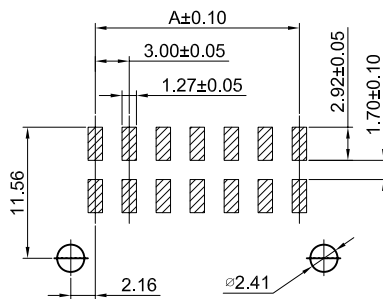
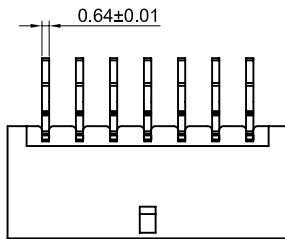

### Ordering Information & Dimensions:

PART NO.	Dimensions	
	A	B
2x1P	----	6.70
2x2P	3.00	9.70
2x3P	6.00	12.70
2x4P	9.00	15.70
2x5P	12.00	18.70
2x6P	15.00	21.70
2x7P	18.00	24.70
2x8P	21.00	27.70
2x9P	24.00	30.70
2x10P	27.00	33.70
2x11P	30.00	36.70
2x12P	33.00	39.70

Unit: mm





# C3030 SERIES 3.00mm pitch wire to wire and wire to board connector

## C3030WRA-S-F1-2xXP

3.00mm pitch 90° Dual Row Wafer - SMT TYPE

### Reference Informations:

- \*Material: Pin: Brass/Tin over Nickel  
Insulator: LCP, UL94V-0
- \*Mates with CJT C3030HF-2xXP series Housing
- \*Color: Black

Ordering Information:  
C3030WRA-S-F1-2xXP - \*\*\* - \*\*\*  
1 2 3

1. Part No.
2. Material:  
(blank): LCP, UL94V-0  
GWT: LCP, UL94V-0, GWT 750°C
3. Finish  
(blank): Tin over Nickel  
G: Gold-flash  
G15: 15µm (0.38µm) MIN. Select Gold  
100µm (2.54µm) MIN. Select Tin  
G30: 30µm (0.76µm) MIN. Select Gold  
100µm (2.54µm) MIN. Select Tin

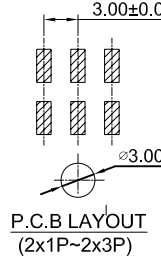
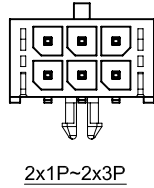
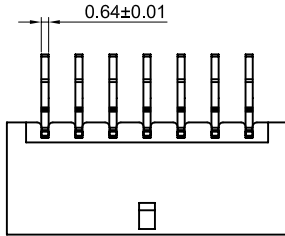
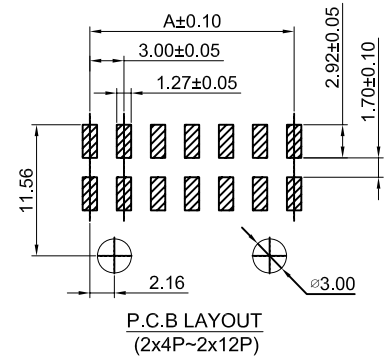

### Ordering Information & Dimensions:

PART NO.	Dimensions	
	A	B
2x1P	----	6.70
2x2P	3.00	9.70
2x3P	6.00	12.70
2x4P	9.00	15.70
2x5P	12.00	18.70
2x6P	15.00	21.70
2x7P	18.00	24.70
2x8P	21.00	27.70
2x9P	24.00	30.70
2x10P	27.00	33.70
2x11P	30.00	36.70
2x12P	33.00	39.70

Unit: mm

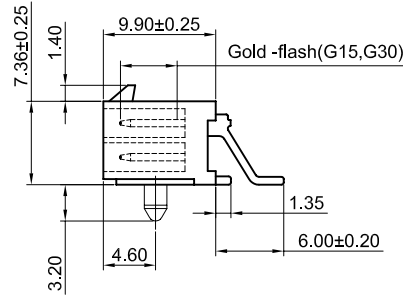
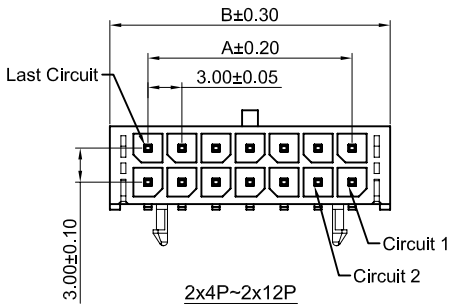

## C3030HFWV-2xXP

3.00mm pitch Dual Row Receptacle Header

### Reference Informations:

- \*Material: LCP, UL94V-0
- \*Mates with CJT C3030HMB-2xXP series Housing  
C3030WVB-2xXP, C3030WRB-2xXP Series Wafer
- \*Color: Black

Ordering Information:  
C3030HFWV-2xXP - \*\*\* - \*\*  
1 2 3

1. Part No.
2. Material:  
(blank): LCP, UL94V-0  
GWT: LCP, UL94V-0, GWT 750°C
3. Finish  
(blank): Tin over Nickel  
G: Gold-flash  
G15: 15µm (0.38µm) MIN. Select Gold  
100µm (2.54µm) MIN. Select Tin  
G30: 30µm (0.76µm) MIN. Select Gold  
100µm (2.54µm) MIN. Select Tin

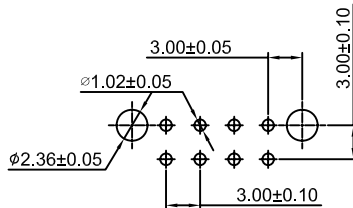
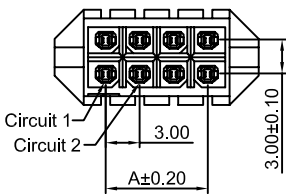
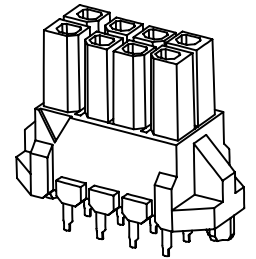

P.C.B LAYOUT

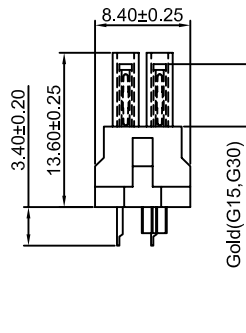
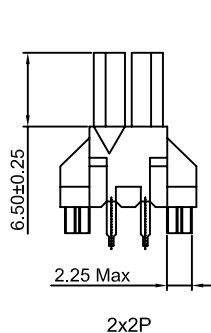
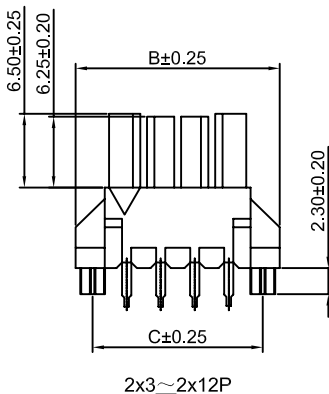

### Ordering Information & Dimensions:

PART NO.	Dimensions		
	A	B	C
2x2P	3.00	12.00	9.00
2x3P	6.00	15.00	12.00
2x4P	9.00	18.00	15.00
2x5P	12.00	21.00	18.00
2x6P	15.00	24.00	21.00
2x7P	18.00	27.00	24.00
2x8P	21.00	30.00	27.00
2x9P	24.00	33.00	30.00
2x10P	27.00	36.00	33.00
2x11P	30.00	39.00	36.00
2x12P	33.00	42.00	39.00

Unit: mm



# C3030 SERIES 3.00mm pitch wire to wire and wire to board connector

## C3030HFWR-2xXP

3.00mm pitch Dual Row Receptacle Header

### Reference Informations:

- \*Material:LCP,UL94V-0
- \*Mates with CJT C3030HMB series Dual Row Housing,C3030WVB,C3030WRB Series Dual Row Wafer
- \*Color:Black

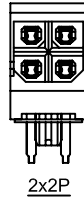
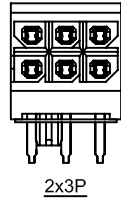
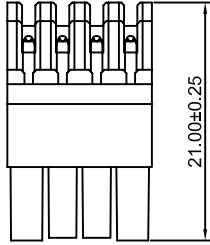
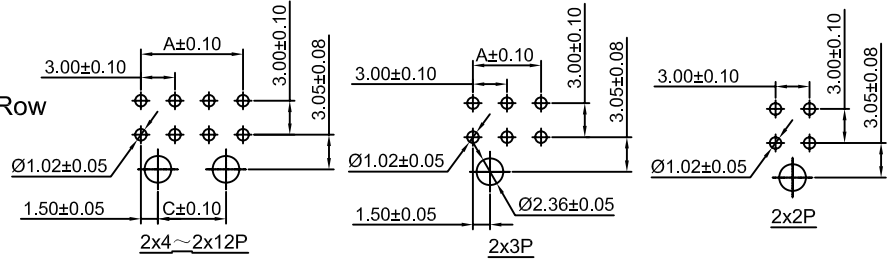

Ordering Information:  
C3030HFWR-2xXP - \*\*\* - \*\*  
1 2 3

1.Part No.  
2.Material:  
(blank):LCP UL94V-0  
GWT:LCP UL94V-0,GWT 750°C  
3.Finish  
(blank):Tin over Nickel  
G:Gold-flash  
G15:15µin (0.38µm) MIN.Select Gold  
100µin (2.54µm) MIN.Select Tin  
G30:30µin (0.76µm) MIN.Select Gold  
100µin (2.54µm) MIN.Select Tin

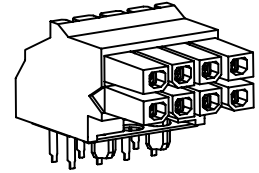

### Ordering Information & Dimensions:

PART NO.	Dimensions		
	A	B	C
2x2P	3.00	6.70	----
2x3P	6.00	9.70	----
2x4P	9.00	12.70	6.00
2x5P	12.00	15.70	9.00
2x6P	15.00	18.70	12.00
2x7P	18.00	21.70	15.00
2x8P	21.00	24.70	18.00
2x9P	24.00	27.70	21.00
2x10P	27.00	30.70	24.00
2x11P	30.00	33.70	27.00
2x12P	33.00	36.70	30.00

Unit: mm

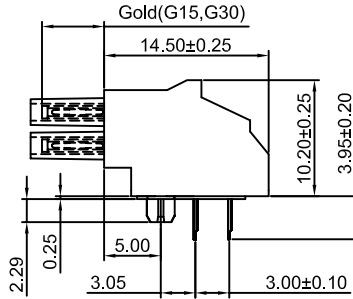
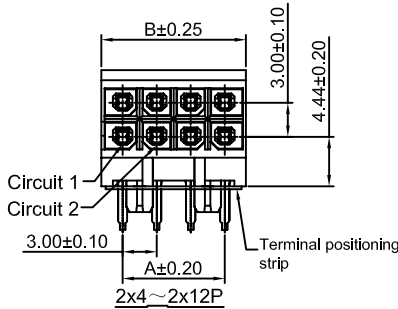

## C3030WVB-2xXP

3.00mm pitch Dual Row 180° Wafer

### Reference Informations:

- \*Material:Pin:Brass/Tin over Nickel  
Insulator:LCP,UL94-V0
- \*Mates with CJT C3030HFB Series Dual Row Housing C3030HFVW,C3030HFWR Dual Row Receptacle Header
- \*Color:Black

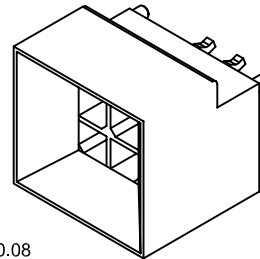

Ordering Information:  
C3030WVB-2xXP - \*\*\* - \*\*  
1 2 3

1.Part No.  
2.Material:  
(blank):LCP UL94V-0  
GWT:LCP UL94V-0,GWT 750°C  
3.Finish  
(blank):Tin over Nickel  
G:Gold-flash  
G15:15µin (0.38µm) MIN.Select Gold  
100µin (2.54µm) MIN.Select Tin  
G30:30µin (0.76µm) MIN.Select Gold  
100µin (2.54µm) MIN.Select Tin

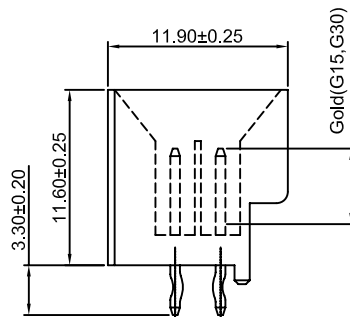
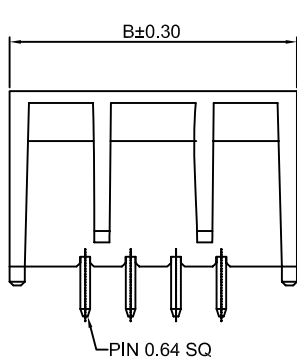
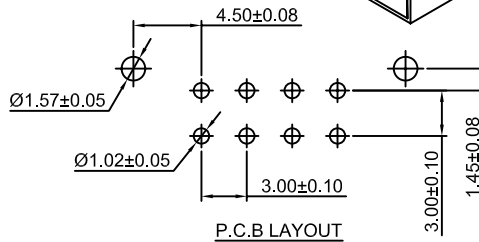
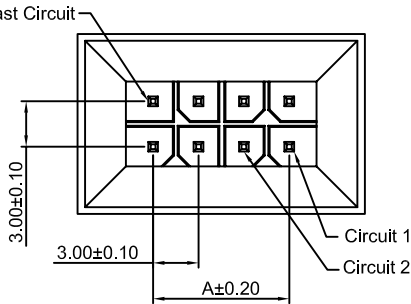

### Ordering Information & Dimensions:

PART NO.	Dimensions	
	A	B
2x2P	3.00	13.00
2x3P	6.00	16.00
2x4P	9.00	19.00
2x5P	12.00	22.00
2x6P	15.00	25.00
2x7P	18.00	28.00
2x8P	21.00	31.00
2x9P	24.00	34.00
2x10P	27.00	37.00
2x11P	30.00	40.00
2x12P	33.00	43.00

Unit: mm





# C3030 SERIES 3.00mm pitch wire to wire and wire to board connector

## C3030WRB-2xXP

3.00mm pitch Dual Row 90° Wafer

### Reference Informations:

- \*Material: Pin: Brass/Tin over Nickel  
Terminal positioning strip: Mylar(Natural)  
Insulator: LCP, UL94-V0
- \*Mates with CJT C3030HFB Series Dual Row Housing  
C3030HFWV, C3030HFWR Dual Row Receptacle Header
- \*Color: Black

### Ordering Information:

C3030WRB-2xXP - \*\*\* - \*\*  
1 2 3

1. Part No.
2. Material:  
(blank): LCP UL94V-0  
GWT: LCP UL94V-0, GWT 750°C
3. Finish  
(blank): Tin over Nickel  
G: Gold-flash  
G15: 15µin (0.38µm) MIN. Select Gold  
100µin (2.54µm) MIN. Select Tin  
G30: 30µin (0.76µm) MIN. Select Gold  
100µin (2.54µm) MIN. Select Tin

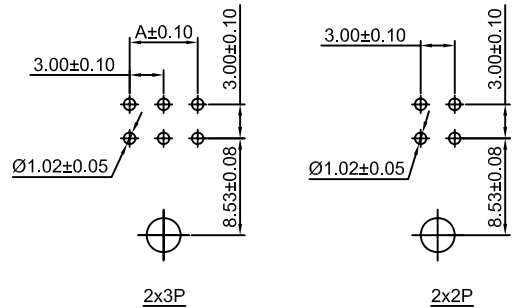
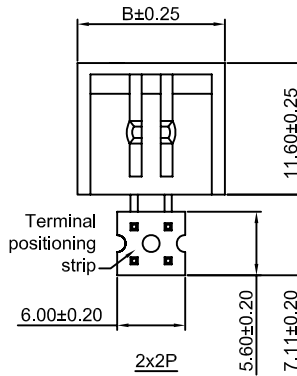
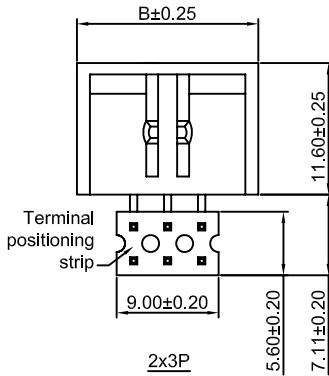
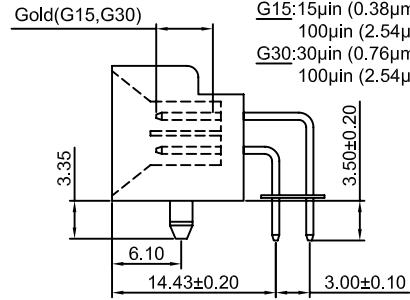
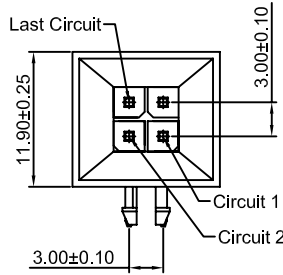
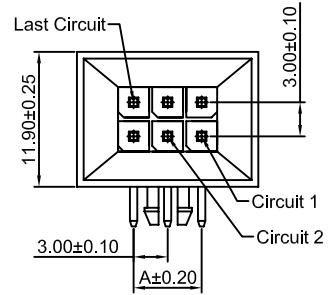

P.C.B LAYOUT

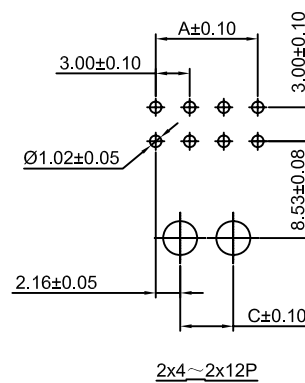
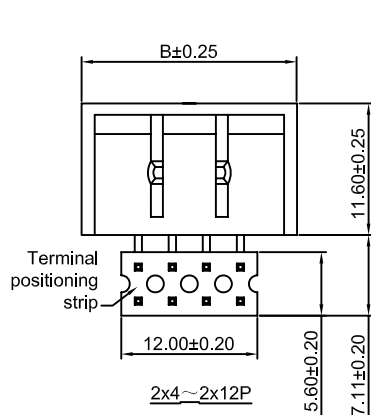
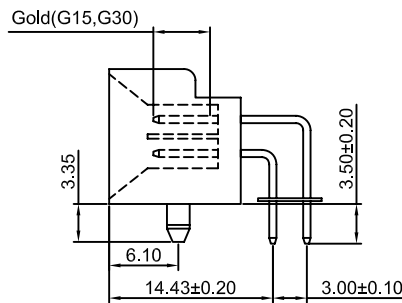
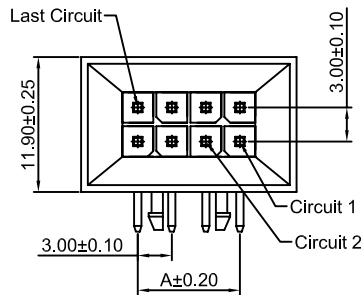

P.C.B LAYOUT

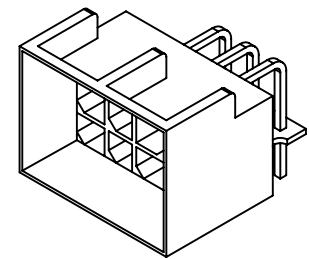

### Ordering Information & Dimensions:

PART NO.	Dimensions		
	A	B	C
2x2P	3.00	13.00	----
2x3P	6.00	16.00	----
2x4P	9.00	19.00	4.68
2x5P	12.00	22.00	7.68
2x6P	15.00	25.00	10.68
2x7P	18.00	28.00	13.68
2x8P	21.00	31.00	16.68
2x9P	24.00	34.00	19.68
2x10P	27.00	37.00	22.68
2x11P	30.00	40.00	25.68
2x12P	33.00	43.00	28.68

Unit: mm



# C3030 SERIES 3.00mm pitch wire to wire and wire to board connector

## C3030WVC-2xXP

3.00mm pitch Dual Row 180° Compliant Pin Interface Wafer

### Reference Informations:

- \*Material:Pin:Brass/Tin over Nickel  
Insulator:LCP,UL94V-0
- \*Mates with CJT C3030HF series dual row Housing
- \*Color:Black

Ordering Information:  
C3030WVC-2xXP - \*\*\* - \*\*  
1 2 3

- 1.Part No.
- 2.Material:  
(blank):LCP UL94V-0  
GWT:LCP UL94V-0,GWT 750 °C
- 3.Finish  
(blank):Tin over Nickel  
G:Gold-flash  
G15:15µm (0.38µm) MIN.Select Gold  
100µm (2.54µm) MIN.Select Tin  
G30:30µm (0.76µm) MIN.Select Gold  
100µm (2.54µm) MIN.Select Tin

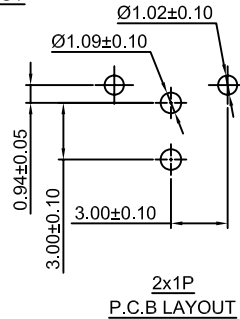
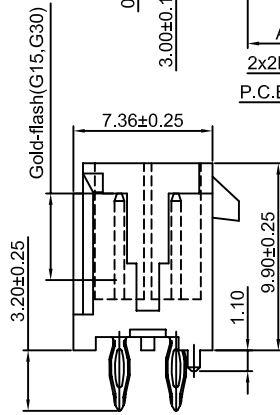
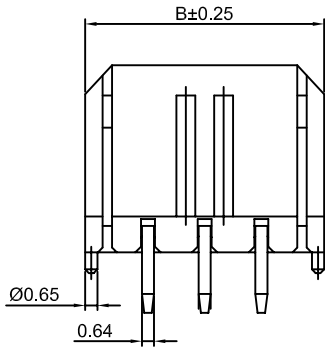
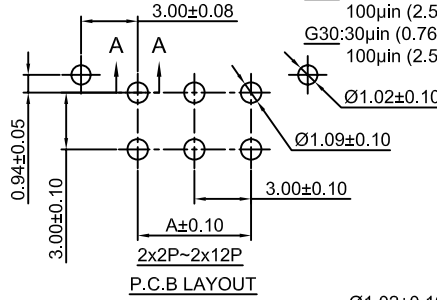
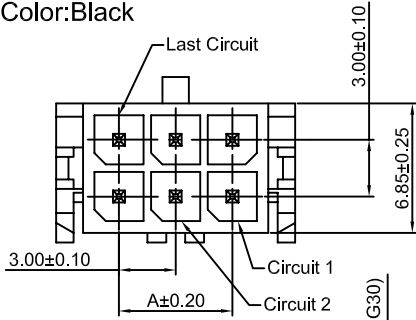
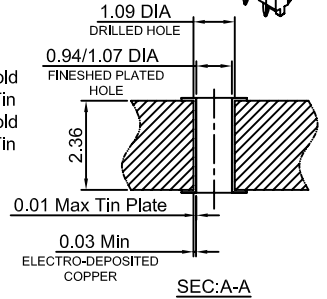
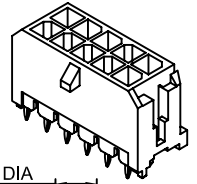

### Ordering Information & Dimensions:

PART NO.	Dimensions	
	A	B
2x1P	----	6.65
2x2P	3.00	9.65
2x3P	6.00	12.65
2x4P	9.00	15.65
2x5P	12.00	18.65
2x6P	15.00	21.65
2x7P	18.00	24.65
2x8P	21.00	27.65
2x9P	24.00	30.65
2x10P	27.00	33.65
2x11P	30.00	36.65
2x12P	33.00	39.65

Unit: mm

## X-ON Electronics

Largest Supplier of Electrical and Electronic Components

*Click to view similar products for [Headers & Wire Housings](#) category:*

*Click to view products by [Changjiang](#) manufacturer:*

Other Similar products are found below :

[95000-104TRLF](#) [10135584-644402LF](#) [DF62W-EP2022PCA](#) [95000-106TRLF](#) [DF62W-2022SCA](#) [DF62W-EP2022PC](#) [2203348](#) [DF62W-2022SC](#) [1084018](#) [1029039](#) [1084017](#) [802-10-012-10-002000](#) [1112640](#) [1112639](#) [891-007-9SS-BST1T](#) [000-34000](#) [0008550134](#) [0009482033](#) [0009507031](#) [57102-F02-18ULF](#) [57102-S06-03LF](#) [57202-S52-04LF](#) [PCN6-15S-2.5E](#) [0039019024](#) [58102-G61-06LF](#) [582553-1](#) [0009485154](#) [0009508121](#) [0022285053](#) [0050291907](#) [018731A](#) [LY20-4P-DT1-P1E-BR](#) [02.125.8002.8](#) [60101931](#) [60598-1 \(Cut Strip\)](#) [M1625-3R/100](#) [61062-3](#) [61082-181009](#) [CSU011177004](#) [636-1427](#) [638009-1](#) [641938-9](#) [641991-4](#) [644168-1](#) [644827-2](#) [647662-1](#) [65039-019ELF](#) [65692-001LF](#) [65781-018](#) [65781-047](#)