

Specifications

Current rating:12.5A AC,DC

Voltage rating:600V AC,DC

Temperature range:-40°C~+105°C

Contact resistance:10mΩ Max.

Insulation resistance:1000MΩ Min.

Withstanding voltage:1500V AC/minute

Compliant with RoHS and REACH

*Meet the HF/Halogen Free,GWT/Glow wire Test
(IEC60335-1) request,need to customize*

Contact CJT for details

Standards



E326732



E326732

Assembly layout

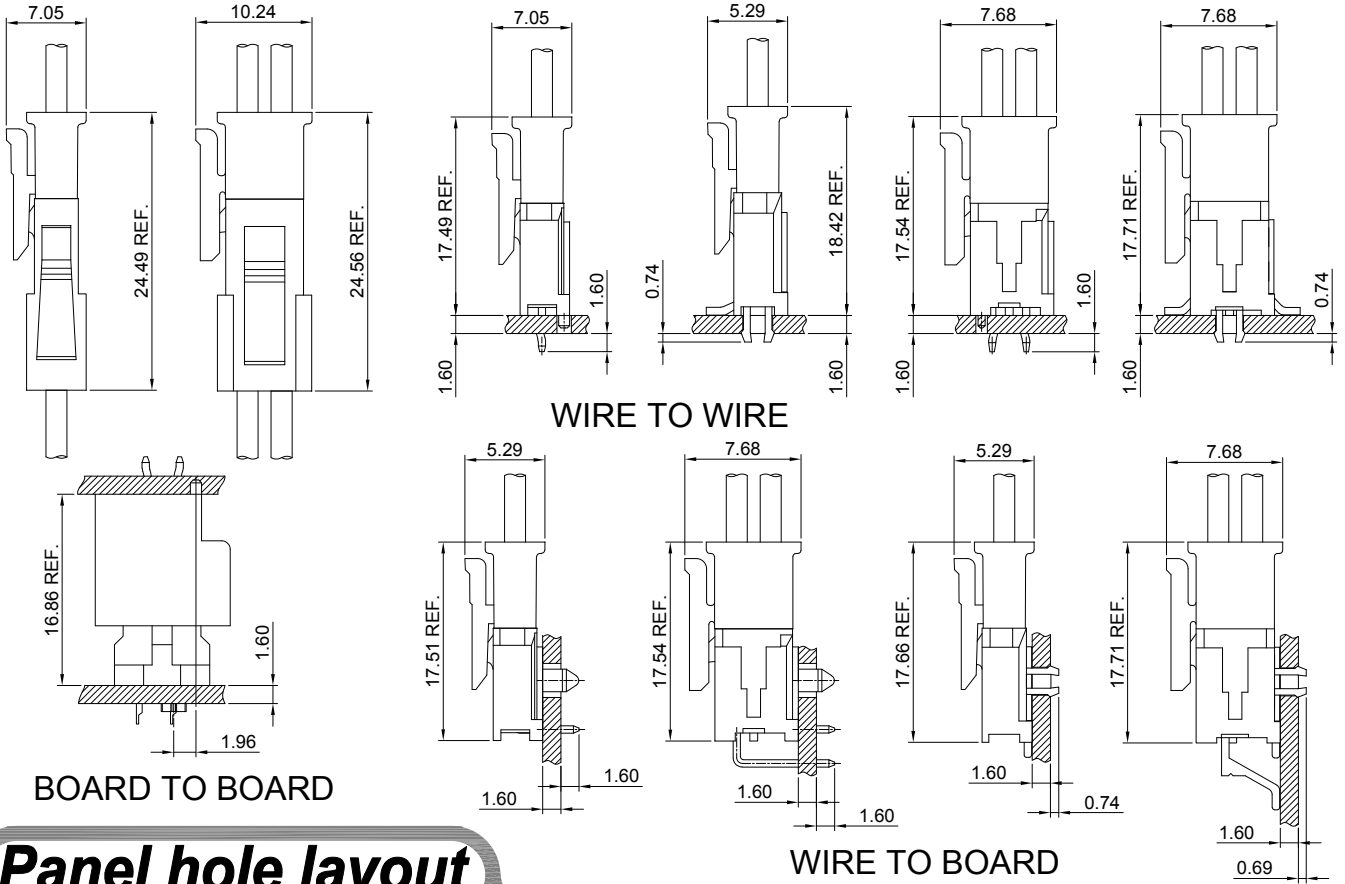

Panel hole layout

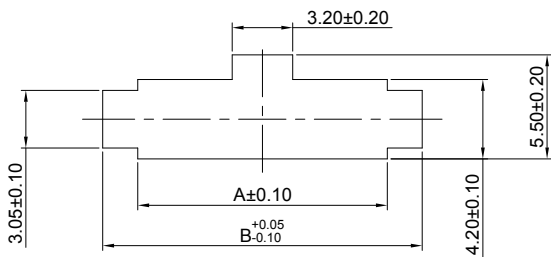

RECOMMENDED PANEL CUT-OUT
 (DESIGNED FOR 1.57mm TO 2.30mm THICK
 STAMPED PANEL OR PRINTED CIRCUIT BOARD)

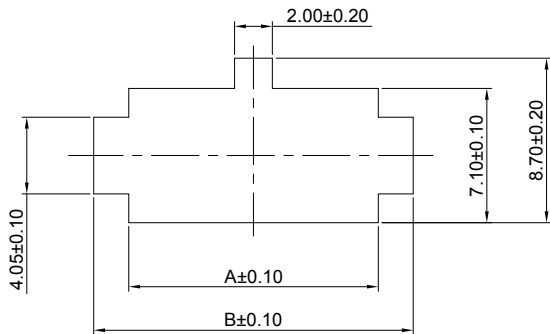

RECOMMENDED PANEL CUT-OUT
 (DESIGNED FOR 1.40mm TO 2.54mm THICK
 STAMPED PANEL OR PRINTED CIRCUIT BOARD)

PART NO.		Dimensions	
SINGLE ROW	DUAL ROW	A	B
-----	C3030HM-2X1P(-A)	4.20	7.90
C3030HM-2P	C3030HM-2X2P(-A)	7.20	10.90
C3030HM-3P	C3030HM-2X3P(-A)	10.20	13.90
C3030HM-4P	C3030HM-2X4P(-A)	13.20	16.90
C3030HM-5P	C3030HM-2X5P(-A)	16.20	19.90
C3030HM-6P	C3030HM-2X6P(-A)	19.20	22.90
C3030HM-7P	C3030HM-2X7P(-A)	22.20	25.90
C3030HM-8P	C3030HM-2X8P(-A)	25.20	28.90
C3030HM-9P	C3030HM-2X9P(-A)	28.20	31.90
C3030HM-10P	C3030HM-2X10P(-A)	31.20	34.90
C3030HM-11P	C3030HM-2X11P(-A)	34.20	37.90
C3030HM-12P	C3030HM-2X12P(-A)	37.20	40.90

Unit:mm

C3030HF

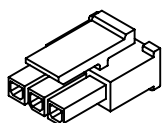

C3030HF

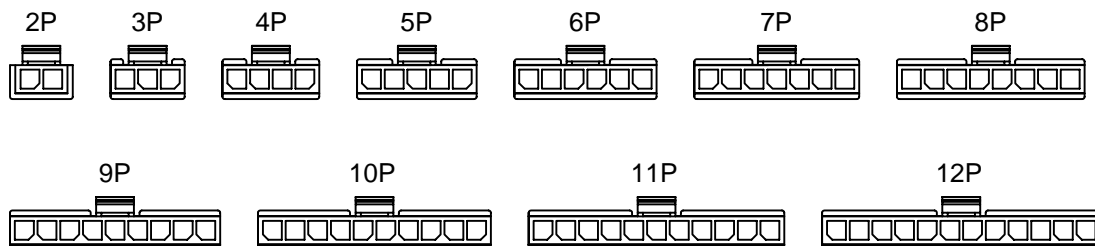

C3030HM C3030HMA

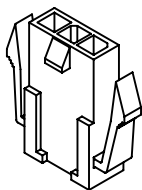

C3030HM

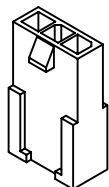

C3030HMA

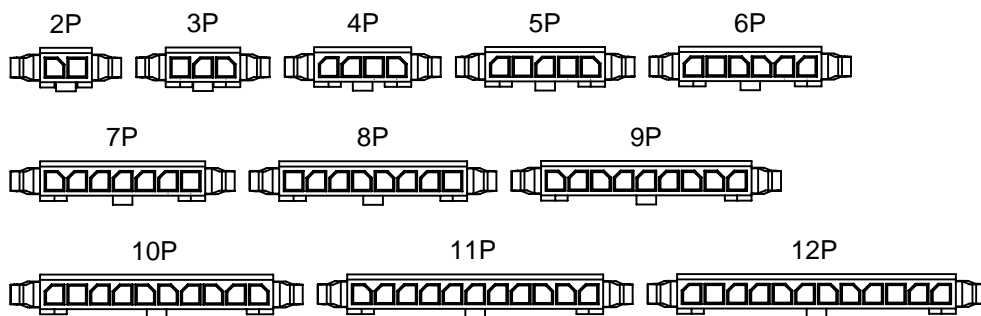

C3030WV C3030WV-S C3030WV-S-F

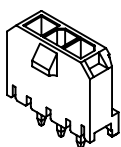

C3030WV

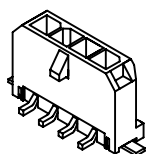

C3030WV-S

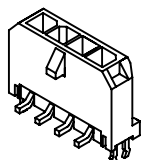

C3030WV-S-F

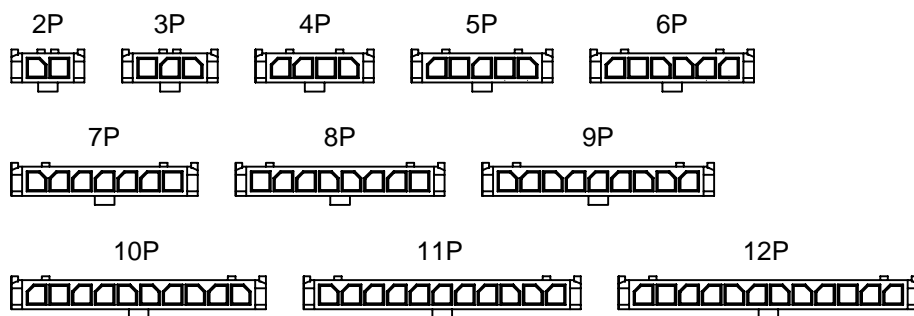

C3030WR C3030WR-S C3030WR-S-F

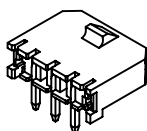

C3030WR

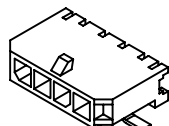

C3030WR-S

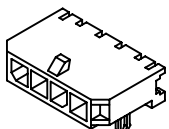

C3030WR-S-F

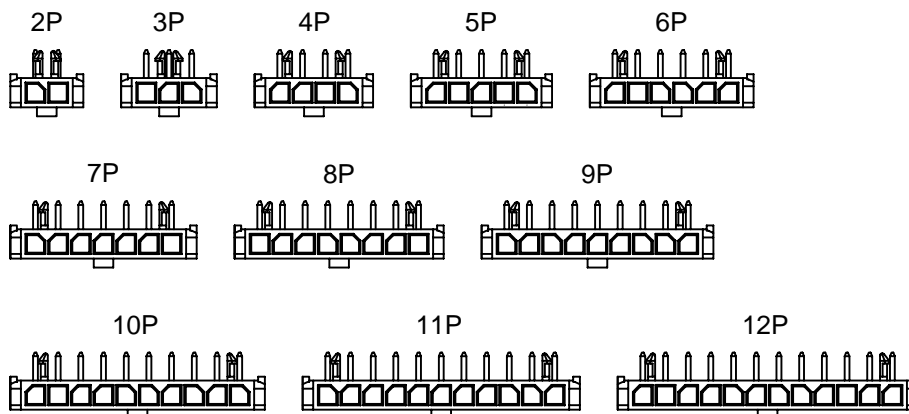

C3030HF-2

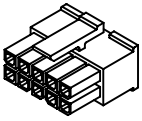

C3030HF-2

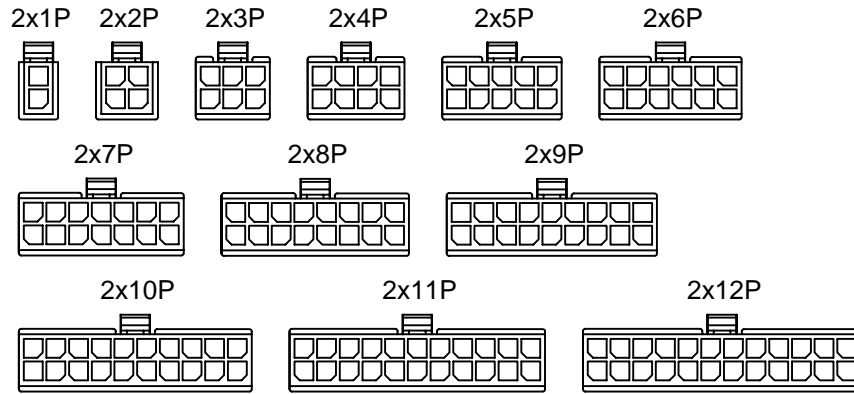

C3030HM-2 C3030HMA-2 C3030HMC-2

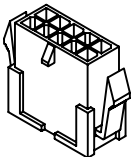

C3030HM-2

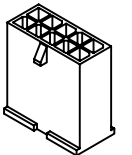

C3030HMC-2

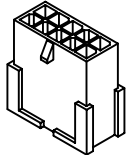

C3030HMA-2

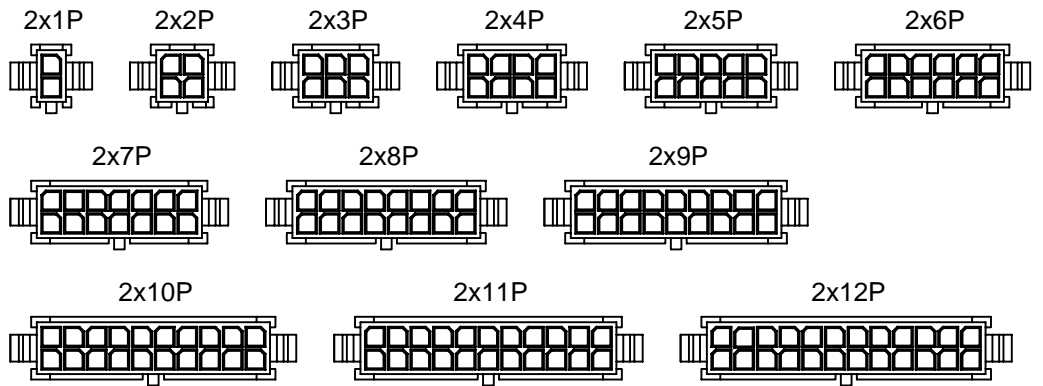

C3030WV-2 C3030WV-S-2 C3030WV-S-F-2

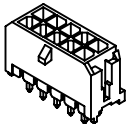

C3030WV-2

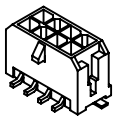

C3030WV-S-2

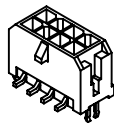

C3030WV-S-F-2

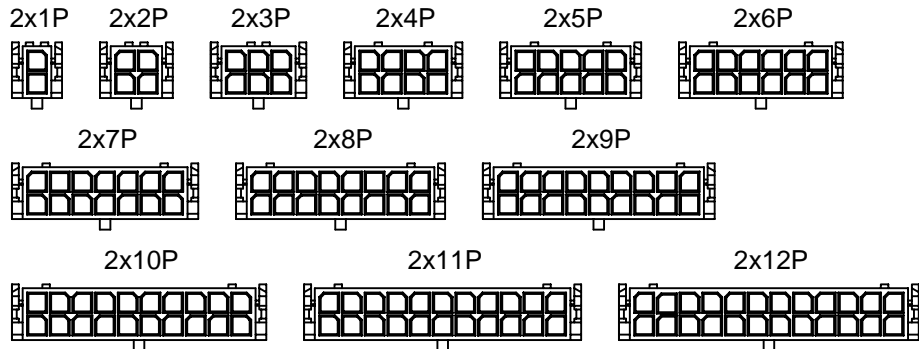

C3030WR-2 C3030WRA-2 C3030WRA-F-2 C3030WR-S-2 C3030WR-S-F-2

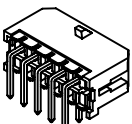

C3030WR-2

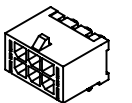

C3030WRA-2

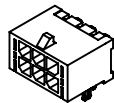

C3030WRA-F-2

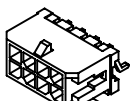

C3030WR-S-2

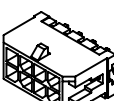

C3030WR-S-F-2

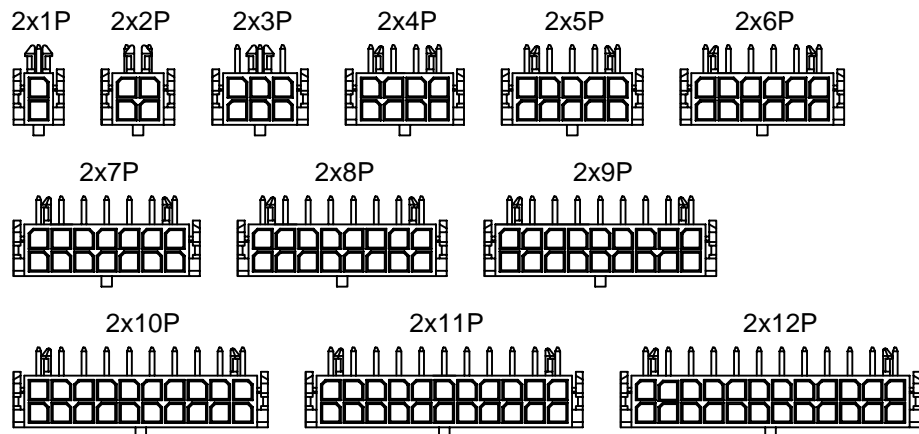

C3030HFB-2

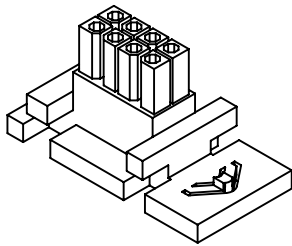

C3030HFB-2

2x1P			2x12P
2x2P			2x11P
2x3P			2x10P
2x4P			2x9P
2x5P			2x8P
2x6P			2x7P

C3030HMB-2

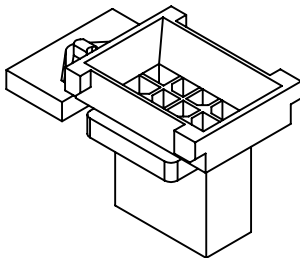

C3030HMB-2

2x1P			2x12P
2x2P			2x11P
2x3P			2x10P
2x4P			2x9P
2x5P			2x8P
2x6P			2x7P

C3030F-T-A

3.00mm pitch Crimp Terminal

Reference Informations:

*Used in CJT C3030HF-2P~12P, C3030HF-2x1P~2x6P series Housing

Ordering Information:

C3030F-GP-A(-L) - ***
1 2

1.Part No.

2.Finish:

(blank): Gold-flash

100µin (2.54µm) MIN.Select Tin

G15:15µin (0.38µm) MIN.Select Gold

100µin (2.54µm) MIN.Select Tin

G30:30µin (0.76µm) MIN.Select Gold

100µin (2.54µm) MIN.Select Tin

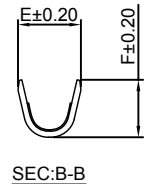
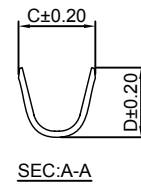
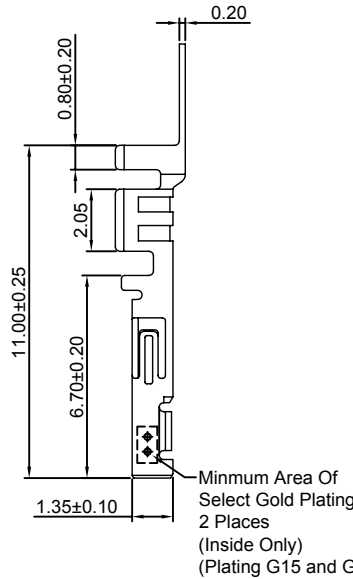
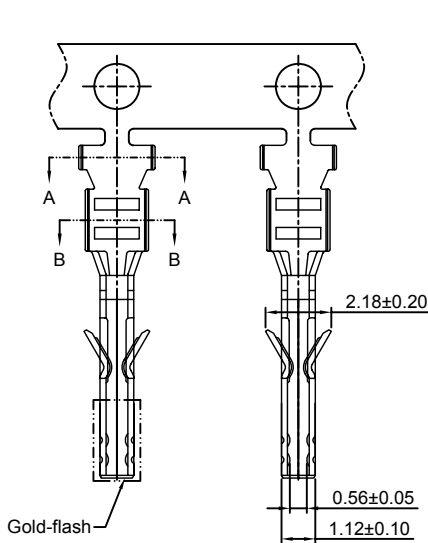

Ordering information & Specifications:

Unit:mm

Part NO.	Wire Range	Insulation O.D.	Material	Finish	C	D	E	F	Qty/reel
C3030F-TP-A	AWG#20-#24	1.85mm(max)	Phosphor Bronze	Tin over Nickel	2.54	2.30	2.08	1.90	10,000 PCS
C3030F-GP-A	AWG#20-#24	1.85mm(max)	Phosphor Bronze	Gold-flash	2.54	2.30	2.08	1.90	10,000 PCS
C3030F-TP-A-L	AWG#26-#30	1.27mm(max)	Phosphor Bronze	Tin over Nickel	2.10	1.90	1.65	1.46	10,000 PCS
C3030F-GP-A-L	AWG#26-#30	1.27mm(max)	Phosphor Bronze	Gold-flash	2.10	1.90	1.65	1.46	10,000 PCS

Optional Gold plating available but MOQ requested

C3030F-T-C

3.00mm pitch Crimp Terminal

Reference Informations:

*Used in CJT C3030HF-2x7P~2x12P, C3030HFB-2xXP series Housing

Ordering Information:

C3030F-GP-C - ***
1 2

1.Part No.

2.Finish:

(blank): Gold-flash

100µin (2.54µm) MIN.Select Tin

G15:15µin (0.38µm) MIN.Select Gold

100µin (2.54µm) MIN.Select Tin

G30:30µin (0.76µm) MIN.Select Gold

100µin (2.54µm) MIN.Select Tin

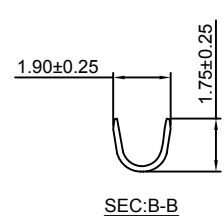
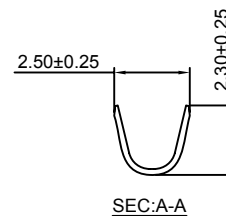
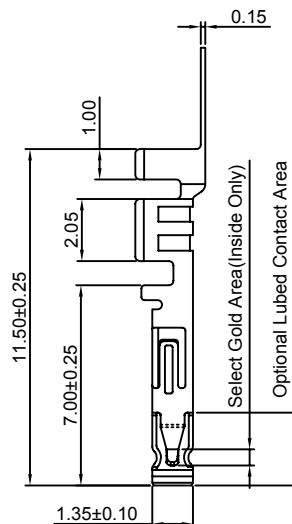
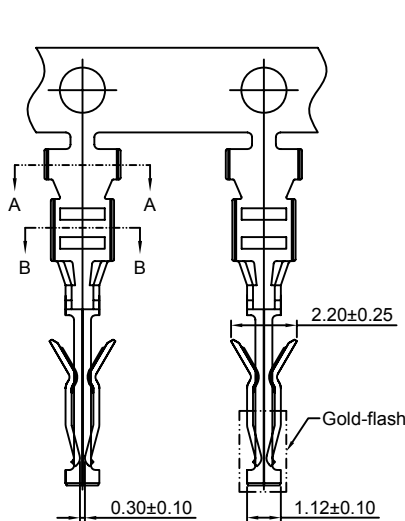

Ordering information & Specifications:

Unit:mm

Part NO.	Wire Range	Insulation O.D.	Material	Finish	Qty/reel
C3030F-TP-C	AWG#20-#24	1.85mm(max)	Phosphor Bronze	Tin over Nickel	10,000 PCS
C3030F-GP-C	AWG#20-#24	1.85mm(max)	Phosphor Bronze	Gold-flash	10,000 PCS

Optional Gold plating available but MOQ requested

C3030M-T

3.00mm pitch Crimp Terminal

Reference Informations:

*Used in CJT C3030HM, HMA-XP, C3030HM, HMA, HMC-2xXP, C3030HM-2xXP-A, C3030HMB-2xXP series Housing

Ordering Information:

C3030M-GP(-L) - ***
 $\frac{1}{2}$

1. Part No.

2. Finish:

(blank): Gold-flash

100µin (2.54µm) MIN. Select Tin

G15: 15µin (0.38µm) MIN. Select Gold

100µin (2.54µm) MIN. Select Tin

G30: 30µin (0.76µm) MIN. Select Gold

100µin (2.54µm) MIN. Select Tin

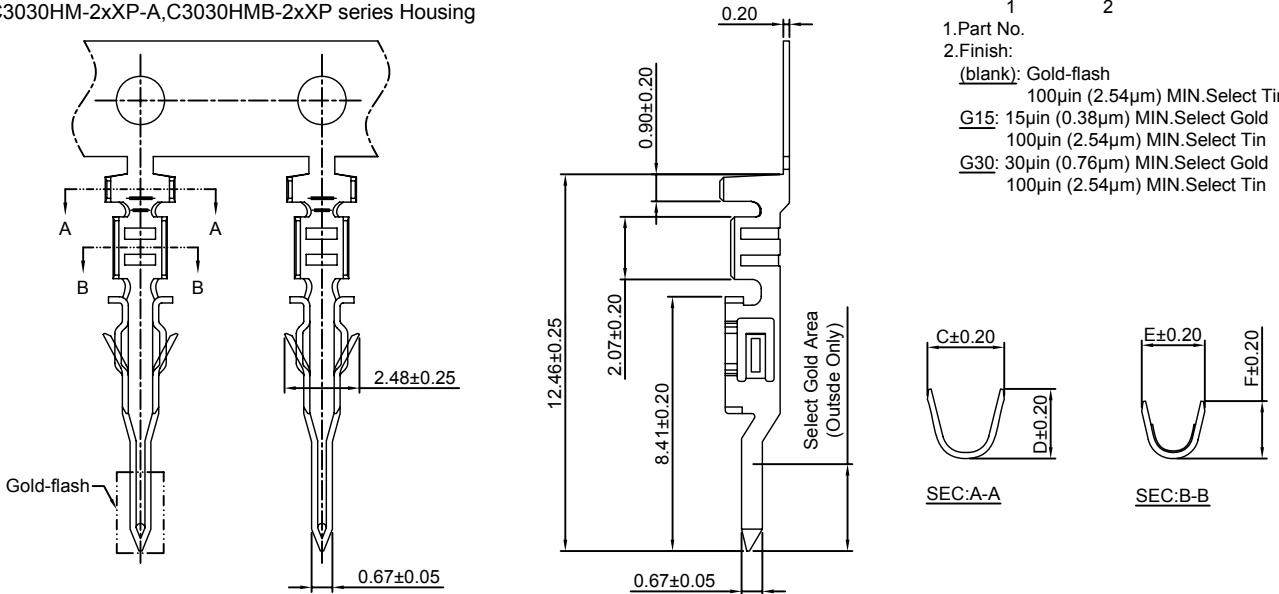

Ordering information & Specifications:

Unit:mm

Part NO.	Wire Range	Insulation O.D.	Material	Finish	C	D	E	F	Qty/reel
C3030M-TP	AWG#20-#24	1.85mm(max)	Phosphor Bronze	Tin over Nickel	2.54	2.30	2.08	1.90	10,000 PCS
C3030M-GP	AWG#20-#24	1.85mm(max)	Phosphor Bronze	Gold-flash	2.54	2.30	2.08	1.90	10,000 PCS
C3030M-TP-L	AWG#26-#30	1.27mm(max)	Phosphor Bronze	Tin over Nickel	2.10	1.90	1.65	1.46	10,000 PCS
C3030M-GP-L	AWG#26-#30	1.27mm(max)	Phosphor Bronze	Gold-flash	2.10	1.90	1.65	1.46	10,000 PCS

Optional Gold plating available but MOQ requested

C3030HMA-XP

3.00mm pitch Single Row Housing

Reference Informations:

- *Material:Nylon 66,UL94V-0
- *Suitable CJT C3030M-T(-L) series Terminal
- *Mates with CJT C3030HF-XP,C3030HF-2P-A series Housing
- *Color:Black

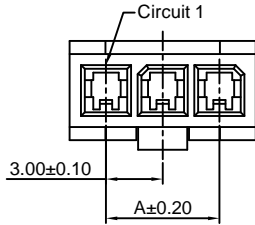

Ordering Information:
C3030HMA-XP - ***
1 2

- 1.Part No.
- 2.Material:
(blank):Nylon 66,UL94V-0
GWT:Nylon 66,UL94V-0,GWT 750 °C

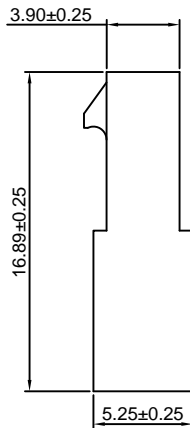
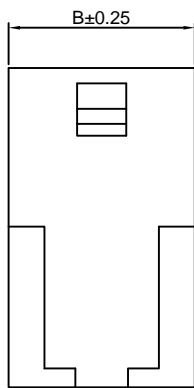
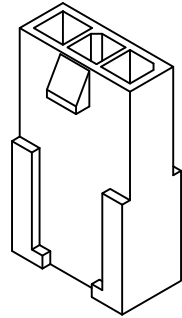

Ordering Information & Dimensions:

PART NO.	Dimensions	
	A	B
2P	3.00	6.85
3P	6.00	9.85
4P	9.00	12.85
5P	12.00	15.85
6P	15.00	18.85
7P	18.00	21.85
8P	21.00	24.85
9P	24.00	27.85
10P	27.00	30.85
11P	30.00	33.85
12P	33.00	36.85

Unit: mm

C3030HF-2xXP

3.00mm pitch Dual Row Housing

Reference Informations:

- *Material:Nylon 66,UL94V-0
- *Suitable CJT C3030F-T-A(-L), C3030F-T-C series Terminal
- *Mates with CJT C3030HM series Housing or C3030 series dual row Wafer
- *Color:Black

Ordering Information:
C3030HF-2xXP(-A) - ***
1 2

- 1.Part No.
- 2.Material:
(blank):Nylon 66,UL94V-0
GWT:Nylon 66,UL94V-0,GWT 750 °C

Mates with CJT C3030 series Housing or Wafer :

Housing	Wafer
C3030HM-2xXP,C3030HMA-2xXP,C3030HM-2xXP-A,C3030HMC-2xXP	C3030WV-2xXP,C3030WV-S-2xXP,C3030WV-F-2xXP
	C3030WF-S-F-2xXP,C3030WR-2xXP,C3030WR-S-2xXP
	C3030WR-F-2xXP,C3030WR-S-F-2xXP,C3030WVA-2xXP
	C3030WVA-S-2xXP,C3030WRA-F-2xXP,C3030WRA-F1-2xXP
	C3030WRA-S-2xXP,C3030WRA-S-F-2xXP
	C3030WRA-S-F1-2xXP,C3030WVC-2xXP

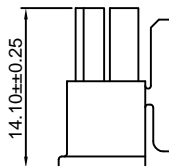
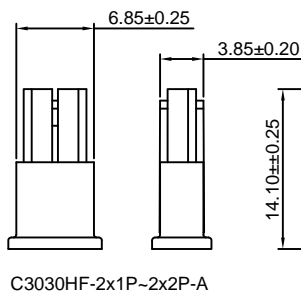
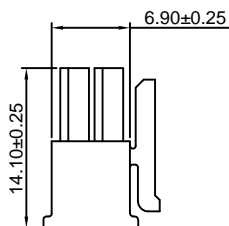
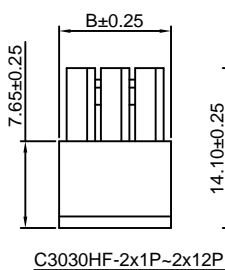
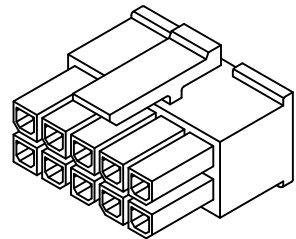
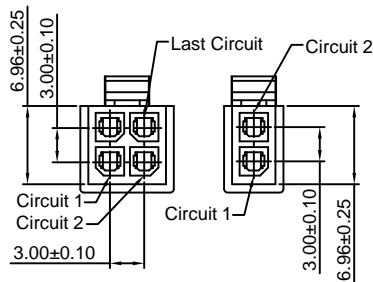
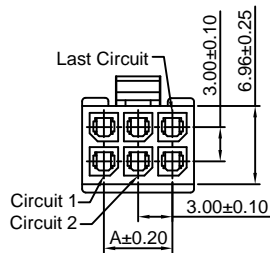

Ordering Information & Dimensions:

PART NO.	Dimensions	
	A	B
2x1P	----	3.85
2x2P	3.00	6.85
2x3P	6.00	9.85
2x4P	9.00	12.85
2x5P	12.00	15.85
2x6P	15.00	18.85
2x7P	18.00	21.85
2x8P	21.00	24.85
2x9P	24.00	27.85
2x10P	27.00	30.85
2x11P	30.00	33.85
2x12P	33.00	36.85

Unit: mm

C3030HM-2xXP

3.00mm pitch Dual Row Housing

Reference Informations:

- *Material:Nylon 66,UL94V-0
- *Suitable CJT C3030M-T(-L) series Terminal
- *Mates with CJT C3030HF-2xXP, C3030HF-2xXP-A series Housing
- *Color:Black

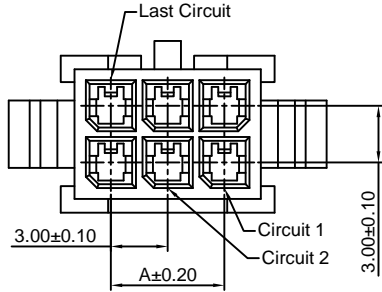

Ordering Information:
C3030HM-2xXP - ***
1 2

- 1.Part No.
- 2.Material:
(blank):Nylon 66,UL94V-0
GWT:Nylon 66,UL94V-0,GWT 750 °C

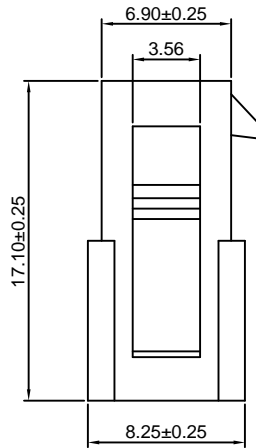
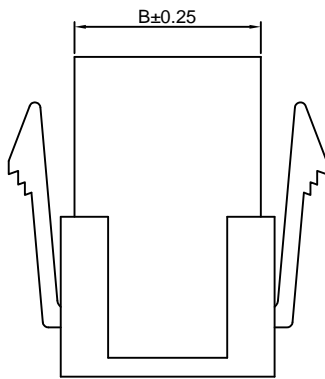
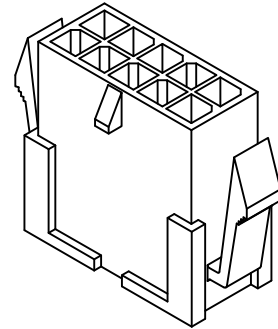

Ordering Information & Dimensions:

PART NO.	Dimensions	
	A	B
2x1P	----	3.85
2x2P	3.00	6.85
2x3P	6.00	9.85
2x4P	9.00	12.85
2x5P	12.00	15.85
2x6P	15.00	18.85
2x7P	18.00	21.85
2x8P	21.00	24.85
2x9P	24.00	27.85
2x10P	27.00	30.85
2x11P	30.00	33.85
2x12P	33.00	36.85

Unit: mm

C3030HM-2xXP-A

3.00mm pitch Dual Row Housing

Reference Informations:

- *Material:Nylon 66,UL94V-0
- *Suitable CJT C3030M-T(-L) series Terminal
- *Mates with CJT C3030HF-2xXP, C3030HF-2xXP-A series Housing
- *Color:Black

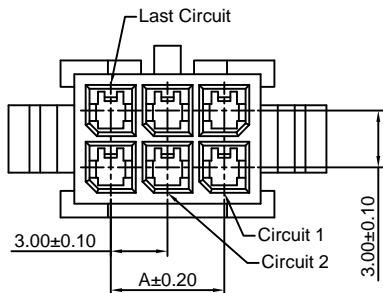

Ordering Information:
C3030HM-2xXP-A - ***
1 2

- 1.Part No.
- 2.Material:
(blank):Nylon 66,UL94V-0
GWT:Nylon 66,UL94V-0,GWT 750 °C

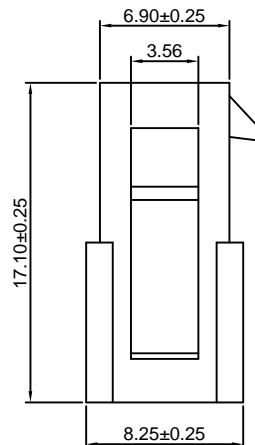
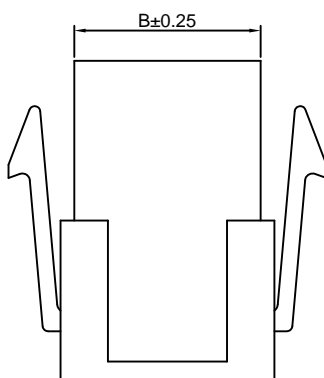
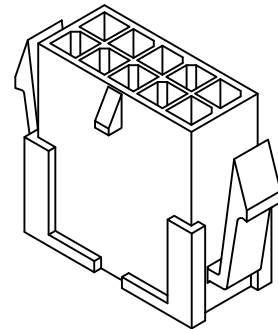

Ordering Information & Dimensions:

PART NO.	Dimensions	
	A	B
2x1P	----	3.85
2x2P	3.00	6.85
2x3P	6.00	9.85
2x4P	9.00	12.85
2x5P	12.00	15.85
2x6P	15.00	18.85
2x7P	18.00	21.85
2x8P	21.00	24.85
2x9P	24.00	27.85
2x10P	27.00	30.85
2x11P	30.00	33.85
2x12P	33.00	36.85

Unit: mm

C3030HMA-2xXP

3.00mm pitch Dual Row Housing

Reference Informations:

- *Material:Nylon 66,UL94V-0
- *Suitable CJT C3030M-T(-L) series Terminal
- *Mates with CJT C3030HF-2xXP, C3030HF-2xXP-A series Housing
- *Color:Black

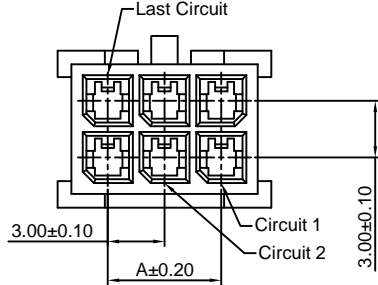

Ordering Information:
C3030HMA-2xXP - ***
1 2

- 1.Part No.
- 2.Material:
(blank):Nylon 66,UL94V-0
GWT:Nylon 66,UL94V-0,GWT 750 °C

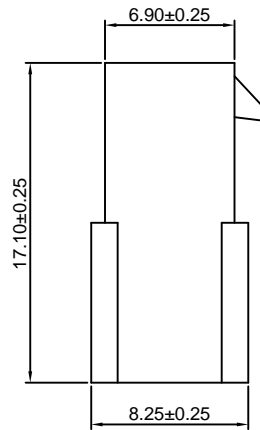
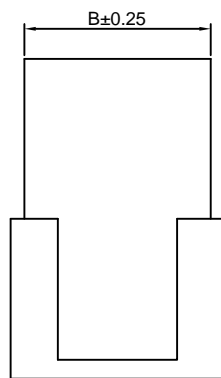
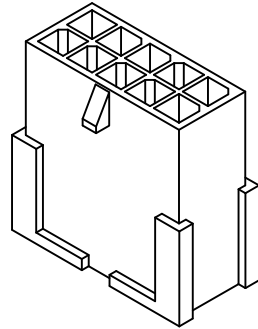

Ordering Information & Dimensions:

PART NO.	Dimensions	
	A	B
2x1P	----	3.85
2x2P	3.00	6.85
2x3P	6.00	9.85
2x4P	9.00	12.85
2x5P	12.00	15.85
2x6P	15.00	18.85
2x7P	18.00	21.85
2x8P	21.00	24.85
2x9P	24.00	27.85
2x10P	27.00	30.85
2x11P	30.00	33.85
2x12P	33.00	36.85

Unit: mm

C3030HMC-2xXP

3.00mm pitch Dual Row Housing

Reference Informations:

- *Material:Nylon 66,UL94V-0
- *Suitable CJT C3030M-T(-L) series Terminal
- *Mates with CJT C3030HF-2xXP, C3030HF-2xXP-A series Housing
- *Color:Black

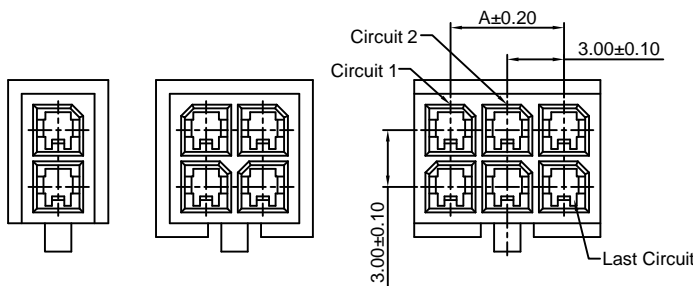

Ordering Information:
C3030HMC-2xXP - ***
1 2

- 1.Part No.
- 2.Material:
(blank):Nylon 66,UL94V-0
GWT:Nylon 66,UL94V-0,GWT 750 °C

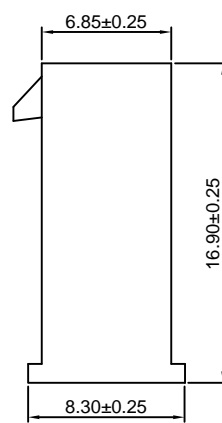
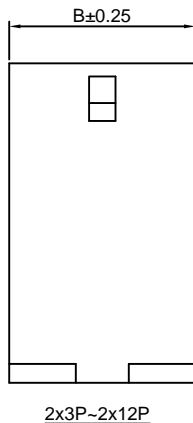
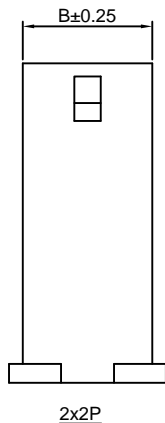
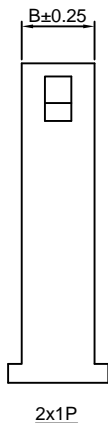
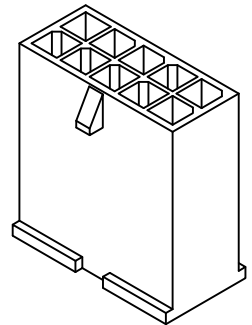

Ordering Information & Dimensions:

PART NO.	Dimensions	
	A	B
2x1P	----	3.85
2x2P	3.00	6.85
2x3P	6.00	9.85
2x4P	9.00	12.85
2x5P	12.00	15.85
2x6P	15.00	18.85
2x7P	18.00	21.85
2x8P	21.00	24.85
2x9P	24.00	27.85
2x10P	27.00	30.85
2x11P	30.00	33.85
2x12P	33.00	36.85

Unit: mm

C3030HFB-2xXP

3.00mm pitch Dual Row Housing

Reference Informations:

- *Material:Nylon 66,UL94V-0
- *Suitable CJT C3030F-T-C series Terminal
- *Mates with CJT C3030HMB-2xXP series Housing or C3030WVB,WRB-2xXP Series Wafer
- *Color:Black

Ordering Information:

- C3030HFB-2xXP - ***
- | | |
|---|---|
| 1 | 2 |
|---|---|
- 1.Part No.
 - 2.Material:
(blank):Nylon 66,UL94V-0
GWT:Nylon 66,UL94V-0,GWT 750 °C

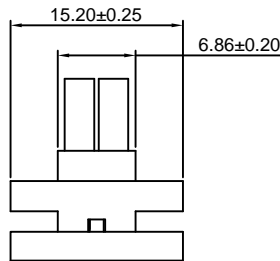
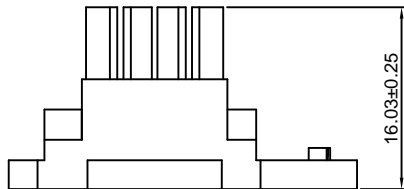
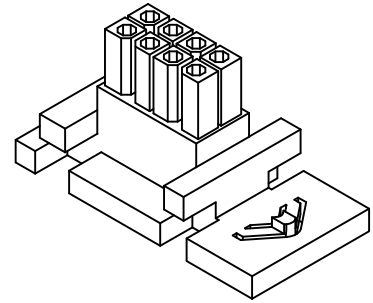
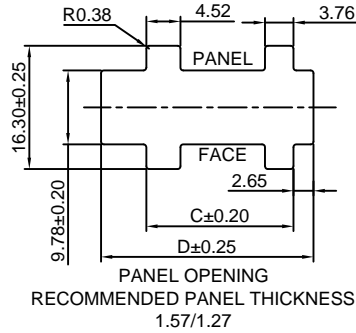
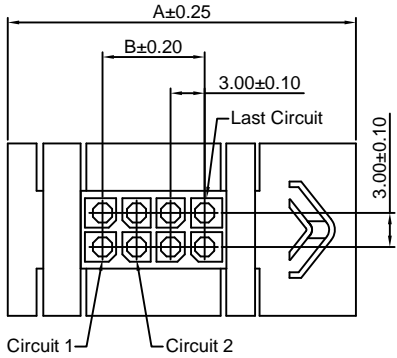

Ordering Information & Dimensions:

PART NO.	Dimensions			
	A	B	C	D
2x2P	24.70	3.00	13.46	22.10
2x3P	27.70	6.00	16.46	25.10
2x4P	30.70	9.00	19.46	28.10
2x5P	33.70	12.00	22.46	31.10
2x6P	36.70	15.00	25.46	34.10
2x7P	39.70	18.00	28.46	37.10
2x8P	42.70	21.00	31.46	40.10
2x9P	45.70	24.00	34.46	43.10
2x10P	48.70	27.00	37.46	46.10
2x11P	51.70	30.00	40.46	49.10
2x12P	54.70	33.00	43.46	52.10

Unit: mm

C3030HMB-2xXP

3.00mm pitch Dual Row Housing

Reference Informations:

- *Material:Nylon 66,UL94V-0
- *Suitable CJT C3030M-T(-L) series Terminal
- *Mates with CJT C3030HFB-2xXP series Housing or C3030HFWV,HFWR-2xXP Receptacle Header
- *Color:Black

Ordering Information:

- C3030HMB-2xXP - ***
- | | |
|---|---|
| 1 | 2 |
|---|---|
- 1.Part No.
 - 2.Material:
(blank):Nylon 66,UL94V-0
GWT:Nylon 66,UL94V-0,GWT 750 °C

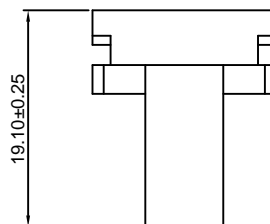
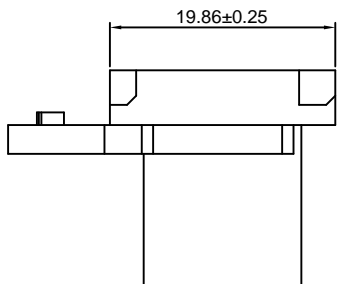
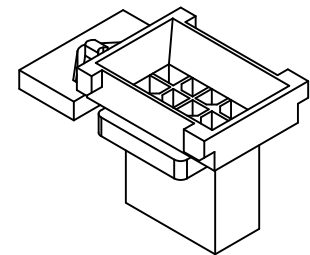
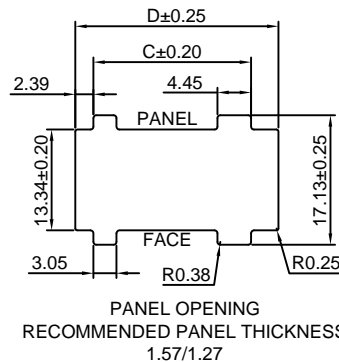
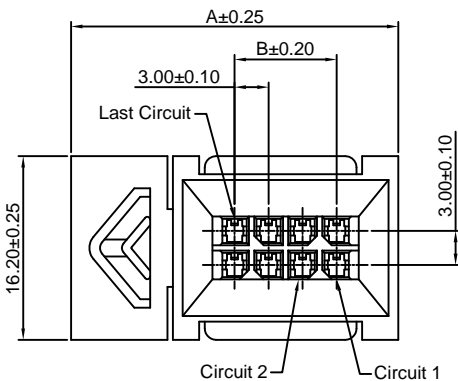

Ordering Information & Dimensions:

PART NO.	Dimensions			
	A	B	C	D
2x2P	22.84	3.00	14.85	20.85
2x3P	25.84	6.00	17.85	23.85
2x4P	28.84	9.00	20.85	26.85
2x5P	31.84	12.00	23.85	29.85
2x6P	34.84	15.00	26.85	32.85
2x7P	37.84	18.00	29.85	35.85
2x8P	40.84	21.00	32.85	38.85
2x9P	43.84	24.00	35.85	41.85
2x10P	46.84	27.00	38.85	44.85
2x11P	49.84	30.00	41.85	47.85
2x12P	52.84	33.00	44.85	50.85

Unit: mm

C3030WV-XP

3.00mm pitch 180° Single Row Wafer

Reference Informations:

- *Material:Pin:Brass/Tin over Nickel
Insulator:Nylon 66,UL94V-0
- *Mates with CJT C3030HF-XP,
C3030HF-2P-A series Housing
- *Color:Black

Ordering Information:

C3030WV-XP - * - *** - ***
1 2 3 4

- 1.Part No.
- 2.Style:
(blank):Type 1
2 :Type 2
3 :Type 3
- 3.Material:
(blank):Nylon 66,UL94V-0
LCP:LCP,UL94V-0
GWT:LCP,UL94V-0,GWT 750°C
- 4.Finish
(blank):Tin over Nickel
G:Gold-flash
G15:15µm (0.38µm) MIN.Select Gold
100µm (2.54µm) MIN.Select Tin
G30:30µm (0.76µm) MIN.Select Gold
100µm (2.54µm) MIN.Select Tin

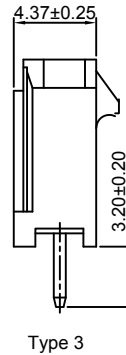
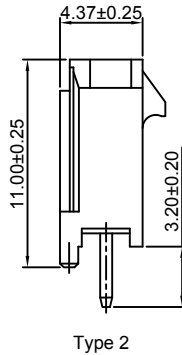
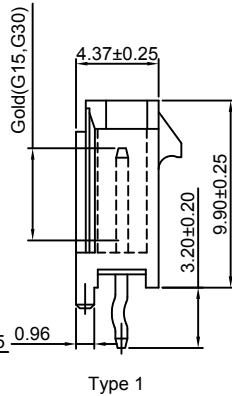
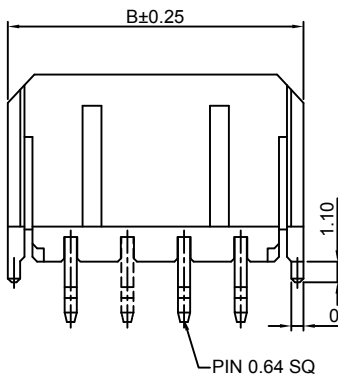
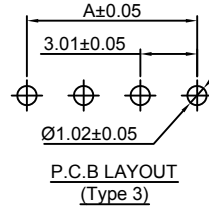
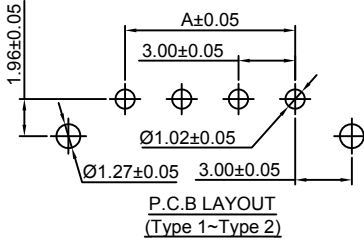
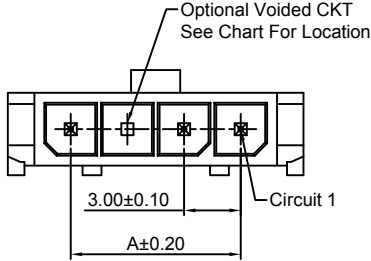
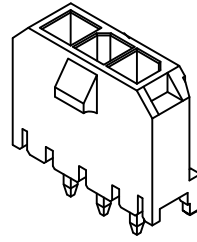

Ordering Information & Dimensions:

PART NO.	Dimensions	
	A	B
2P	3.00	9.65
3P	6.00	12.65
4P	9.00	15.65
5P	12.00	18.65
6P	15.00	21.65
7P	18.00	24.65
8P	21.00	27.65
9P	24.00	30.65
10P	27.00	33.65
11P	30.00	36.65
12P	33.00	39.65

Unit: mm

C3030WR-XP

3.00mm pitch 90° Single Row Wafer

Reference Informations:

- *Material:Pin:Brass/Tin over Nickel
Insulator:Nylon 66,UL94V-0
- *Mates with CJT C3030HF-XP,
C3030HF-2P-A series Housing
- *Color:Black

Ordering Information:

C3030WR-XP - *** - ***
1 2 3

- 1.Part No.
- 2.Material:
(blank):Nylon 66, UL94V-0
LCP:LCP,UL94V-0
GWT:LCP,UL94V-0,GWT 750°C
- 3.Finish
(blank):Tin over Nickel
G:Gold-flash
G15:15µm (0.38µm) MIN.Select Gold
100µm (2.54µm) MIN.Select Tin
G30:30µm (0.76µm) MIN.Select Gold
100µm (2.54µm) MIN.Select Tin

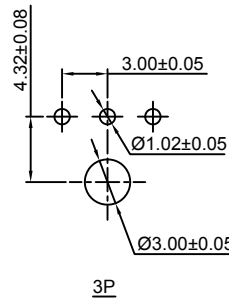
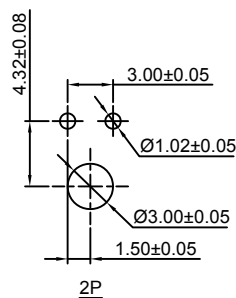
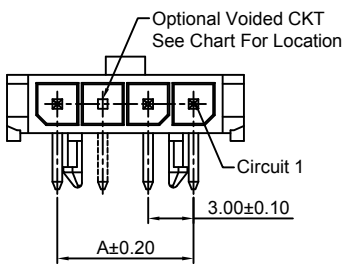
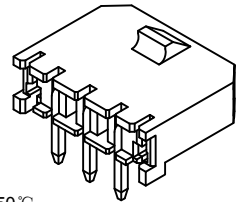

P.C.B LAYOUT

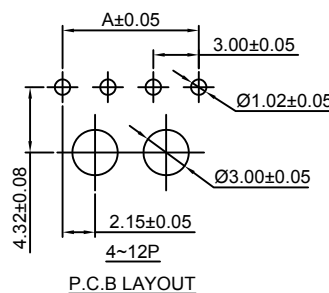
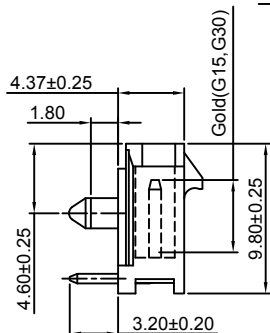
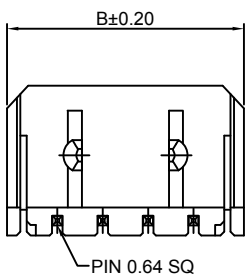

P.C.B LAYOUT

Ordering Information & Dimensions:

PART NO.	Dimensions	
	A	B
2P	3.00	9.65
3P	6.00	12.65
4P	9.00	15.65
5P	12.00	18.65
6P	15.00	21.65
7P	18.00	24.65
8P	21.00	27.65
9P	24.00	30.65
10P	27.00	33.65
11P	30.00	36.65
12P	33.00	39.65

Unit: mm

C3030WV-F-XP

3.00mm pitch 180° Single Row Wafer

Reference Informations:

- *Material:Pin:Brass/Tin over Nickel
Insulator:Nylon 66,UL94V-0
- *Mates with CJT C3030HF-XP,
C3030HF-2P-A series Housing
- *Color:Black

Ordering Information:

C3030WV-F-XP - *** - ***
1 2 3

- Part No.
- Material:
(blank):Nylon 66, UL94V-0
LCP:LCP,UL94V-0
GWT:LCP, UL94V-0,GWT 750 °C
- Finish
(blank):Tin over Nickel
G:Gold-flash
G15:15µin (0.38µm) MIN.Select Gold
100µin (2.54µm) MIN.Select Tin
G30:30µin (0.76µm) MIN.Select Gold
100µin (2.54µm) MIN.Select Tin

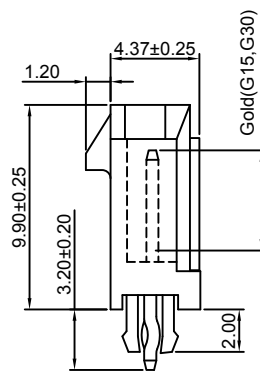
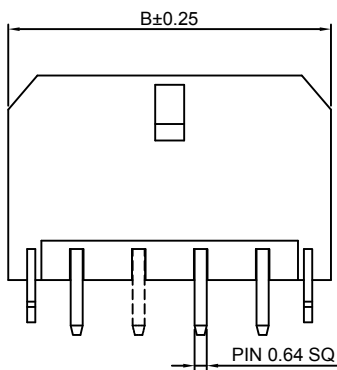
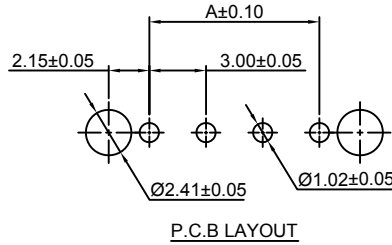
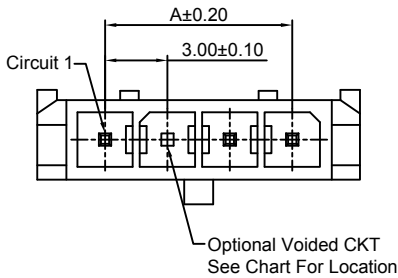

Ordering Information & Dimensions:

PART NO.	Dimensions	
	A	B
2P	3.00	9.65
3P	6.00	12.65
4P	9.00	15.65
5P	12.00	18.65
6P	15.00	21.65
7P	18.00	24.65
8P	21.00	27.65
9P	24.00	30.65
10P	27.00	33.65
11P	30.00	36.65
12P	33.00	39.65

Unit: mm

C3030WR-F-XP

3.00mm pitch 90° Single Row Wafer

Reference Informations:

- *Material:Pin:Brass/Tin over Nickel
Insulator:Nylon 66,UL94V-0
- *Mates with CJT C3030HF-XP,
C3030HF-2P-A series Housing
- *Color:Black

Ordering Information:

C3030WR-F-XP - *** - ***
1 2 3

- Part No.
- Material:
(blank):Nylon 66, UL94V-0
LCP:LCP,UL94V-0
GWT:LCP, UL94V-0,GWT 750 °C
- Finish
(blank):Tin over Nickel
G:Gold-flash
G15:15µin (0.38µm) MIN.Select Gold
100µin (2.54µm) MIN.Select Tin
G30:30µin (0.76µm) MIN.Select Gold
100µin (2.54µm) MIN.Select Tin

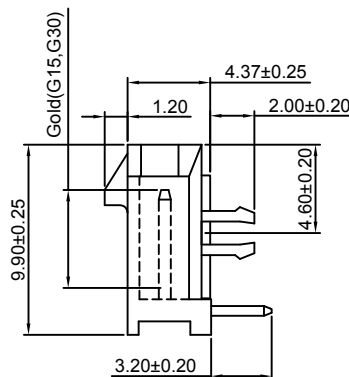
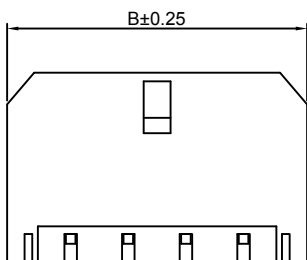
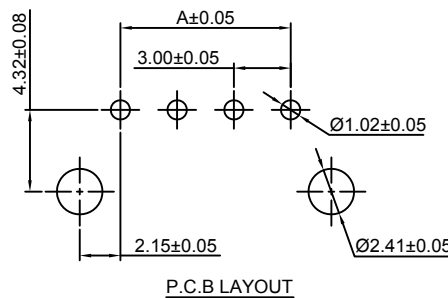
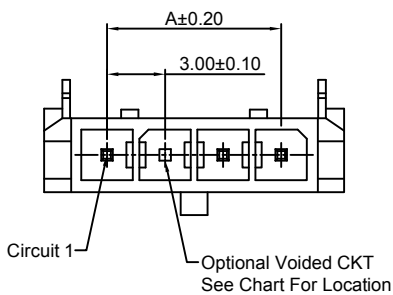

Ordering Information & Dimensions:

PART NO.	Dimensions	
	A	B
2P	3.00	9.65
3P	6.00	12.65
4P	9.00	15.65
5P	12.00	18.65
6P	15.00	21.65
7P	18.00	24.65
8P	21.00	27.65
9P	24.00	30.65
10P	27.00	33.65
11P	30.00	36.65
12P	33.00	39.65

Unit: mm

C3030WV-S-XP

3.00mm pitch 180° Single Row Wafer-SMT TYPE

Reference Informations:

- *Material:Pin:Brass/Tin over Nickel
Insulator:LCP,UL94V-0
- *Mates with CJT C3030HF-XP,
C3030HF-2P-A series Housing
- *Color:Black

Ordering Information:

C3030WV-S-XP - *** - ***
1 2 3

- 1.Part No.
- 2.Material:
(blank):LCP,UL94V-0
GWT:LCP,UL94V-0,GWT 750°C
- 3.Finish
(blank):Tin over Nickel
G:Gold-flash
G15:15µin (0.38µm) MIN.Select Gold
100µin (2.54µm) MIN.Select Tin
G30:30µin (0.76µm) MIN.Select Gold
100µin (2.54µm) MIN.Select Tin

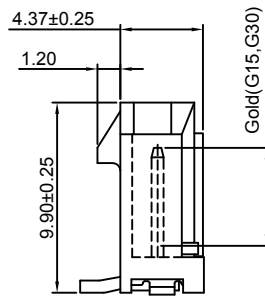
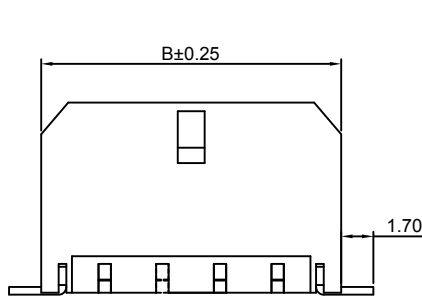
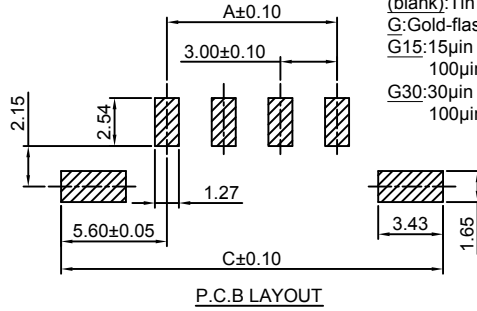
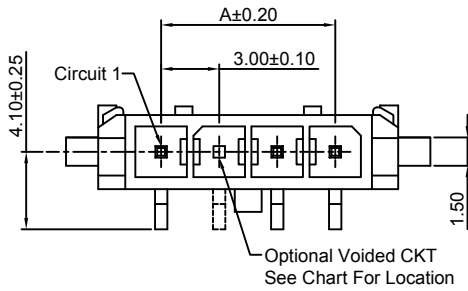
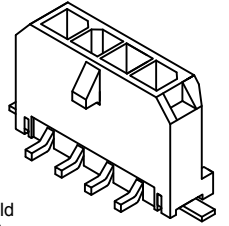

Ordering Information & Dimensions:

PART NO.	Dimensions		
	A	B	C
2P	3.00	9.65	14.20
3P	6.00	12.65	17.20
4P	9.00	15.65	20.20
5P	12.00	18.65	23.20
6P	15.00	21.65	26.20
7P	18.00	24.65	29.20
8P	21.00	27.65	32.20
9P	24.00	30.65	35.20
10P	27.00	33.65	38.20
11P	30.00	36.65	41.20
12P	33.00	39.65	44.20

Unit: mm

C3030WR-S-XP

3.00mm pitch 90° Single Row Wafer-SMT TYPE

Reference Informations:

- *Material:Pin:Brass/Tin over Nickel
Insulator:LCP,UL94V-0
- *Mates with CJT C3030HF-XP,
C3030HF-2P-A series Housing
- *Color:Black

Ordering Information:

C3030WR-S-XP - *** - ***
1 2 3

- 1.Part No.
- 2.Material:
(blank):LCP,UL94V-0
GWT:LCP,UL94V-0,GWT 750°C
- 3.Finish
(blank):Tin over Nickel
G:Gold-flash
G15:15µin (0.38µm) MIN.Select Gold
100µin (2.54µm) MIN.Select Tin
G30:30µin (0.76µm) MIN.Select Gold
100µin (2.54µm) MIN.Select Tin

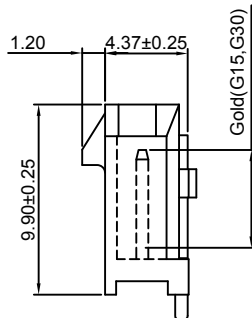
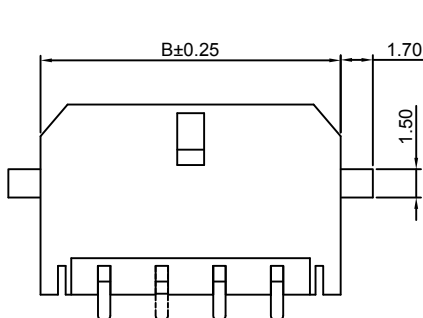
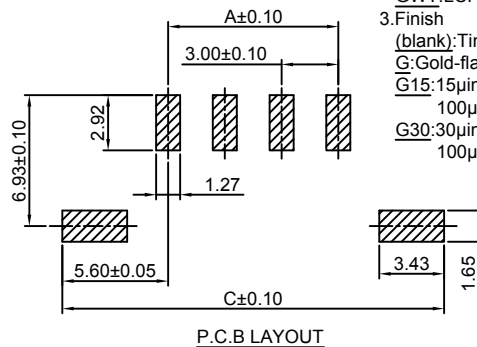
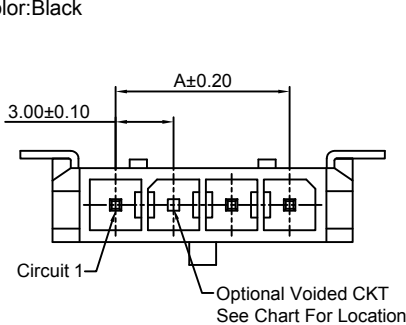
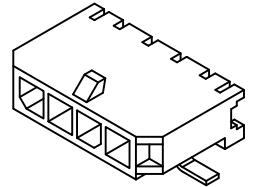

Ordering Information & Dimensions:

PART NO.	Dimensions		
	A	B	C
2P	3.00	9.65	14.20
3P	6.00	12.65	17.20
4P	9.00	15.65	20.20
5P	12.00	18.65	23.20
6P	15.00	21.65	26.20
7P	18.00	24.65	29.20
8P	21.00	27.65	32.20
9P	24.00	30.65	35.20
10P	27.00	33.65	38.20
11P	30.00	36.65	41.20
12P	33.00	39.65	44.20

Unit: mm

C3030WV-S-F-XP

3.00mm pitch 180° Single Row Wafer-SMT TYPE

Reference Informations:

*Material:Pin:Brass/Tin over Nickel
Insulator:LCP,UL94V-0

*Mates with CJT C3030HF-XP,
C3030HF-2P-A series Housing

*Color:Black

Ordering Information:

C3030WV-S-F-XP - *** - **
1 2 3

1.Part No.

2.Material:

(blank):LCP,UL94V-0

GWT:LCP,UL94V-0,GWT 750 °C

3.Finish

(blank):Tin over Nickel

G:Gold-flash

G15:15µin (0.38µm) MIN.Select Gold

100µin (2.54µm) MIN.Select Tin

G30:30µin (0.76µm) MIN.Select Gold

100µin (2.54µm) MIN.Select Tin

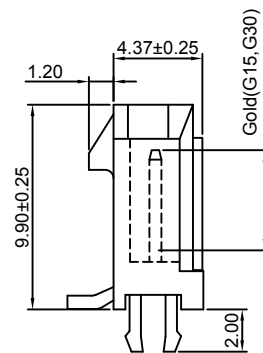
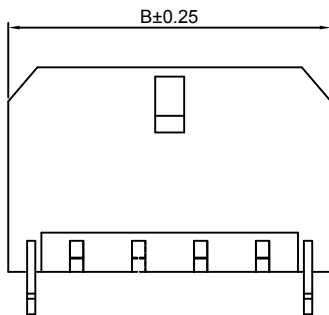
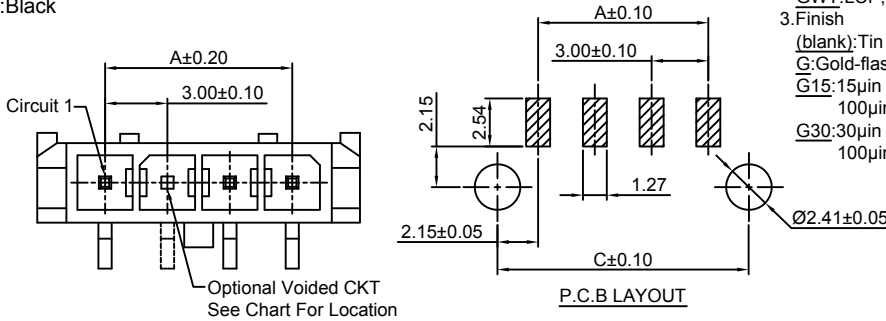
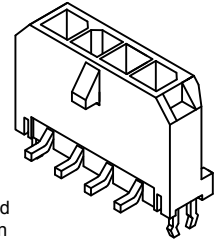

Ordering Information & Dimensions:

PART NO.	Dimensions		
	A	B	C
2P	3.00	9.65	7.30
3P	6.00	12.65	10.30
4P	9.00	15.65	13.30
5P	12.00	18.65	16.30
6P	15.00	21.65	19.30
7P	18.00	24.65	22.30
8P	21.00	27.65	25.30
9P	24.00	30.65	28.30
10P	27.00	33.65	31.30
11P	30.00	36.65	34.30
12P	33.00	39.65	37.30

Unit: mm

C3030WR-S-F-XP

3.00mm pitch 90° Single Row Wafer-SMT TYPE

Reference Informations:

*Material:Pin:Brass/Tin over Nickel
Insulator:LCP,UL94V-0

*Mates with CJT C3030HF-XP,
C3030HF-2P-A series Housing

*Color:Black

Ordering Information:

C3030WR-S-F-XP - *** - **
1 2 3

1.Part No.

2.Material:

(blank):LCP,UL94V-0

GWT:LCP,UL94V-0,GWT 750 °C

3.Finish

(blank):Tin over Nickel

G:Gold-flash

G15:15µin (0.38µm) MIN.Select Gold

100µin (2.54µm) MIN.Select Tin

G30:30µin (0.76µm) MIN.Select Gold

100µin (2.54µm) MIN.Select Tin

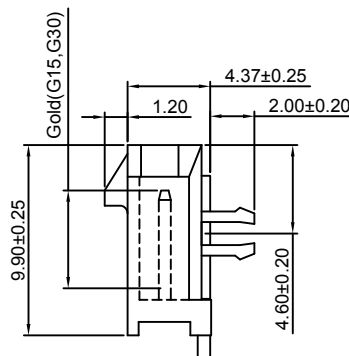
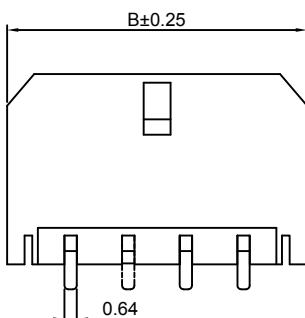
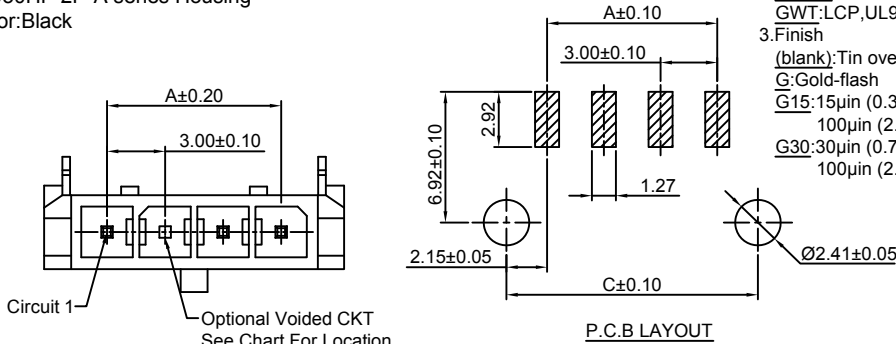
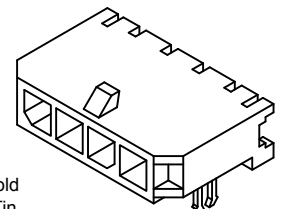

Ordering Information & Dimensions:

PART NO.	Dimensions		
	A	B	C
2P	3.00	9.65	7.30
3P	6.00	12.65	10.30
4P	9.00	15.65	13.30
5P	12.00	18.65	16.30
6P	15.00	21.65	19.30
7P	18.00	24.65	22.30
8P	21.00	27.65	25.30
9P	24.00	30.65	28.30
10P	27.00	33.65	31.30
11P	30.00	36.65	34.30
12P	33.00	39.65	37.30

Unit: mm

C3030WV-2xXP

3.00mm pitch 180° Dual Row Wafer

Reference Informations:

- *Material: Pin: Brass/Tin over Nickel
Insulator: Nylon 66, UL94V-0
- *Mates with CJT C3030HF-2xXP, C3030HF-2xXP-A series Housing
- *Color: Black

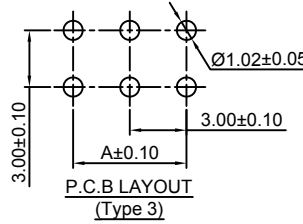
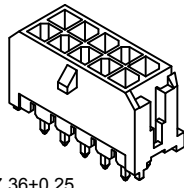
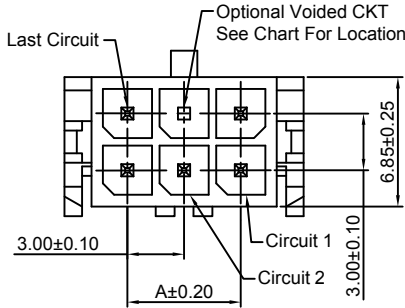

Ordering Information:
C3030WV-2xXP - * - *** - ***
1 2 3 4

1. Part No.
2. Style:
(blank) : Type 1
2 : Type 2
3. Material:
(blank) : Nylon 66, UL94V-0
LCP: LCP, UL94V-0
GWT: LCP, UL94V-0, GWT 750°C
4. Finish
(blank) : Tin over Nickel
G: Gold-flash
G15: 15µin (0.38µm) MIN. Select Gold
100µin (2.54µm) MIN. Select Tin
G30: 30µin (0.76µm) MIN. Select Gold
100µin (2.54µm) MIN. Select Tin

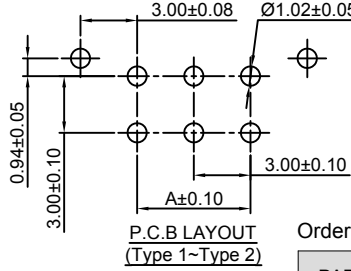
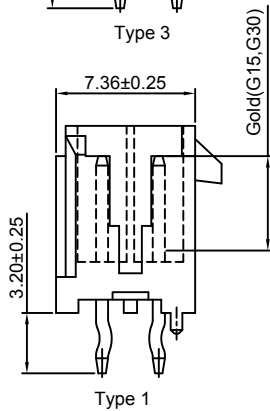
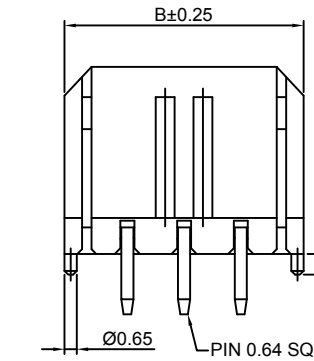

Ordering Information & Dimensions:

PART NO.	Dimensions	
	A	B
2x1P	---	6.65
2x2P	3.00	9.65
2x3P	6.00	12.65
2x4P	9.00	15.65
2x5P	12.00	18.65
2x6P	15.00	21.65
2x7P	18.00	24.65
2x8P	21.00	27.65
2x9P	24.00	30.65
2x10P	27.00	33.65
2x11P	30.00	36.65
2x12P	33.00	39.65

Unit: mm

C3030WR-2xXP

3.00mm pitch 90° Dual Row Wafer With Foot

Reference Informations:

- *Material: Pin: Brass/Tin over Nickel
Insulator: Nylon 66, UL94V-0
- *Mates with CJT C3030HF-2xXP, C3030HF-2xXP-A series Housing
- *Color: Black

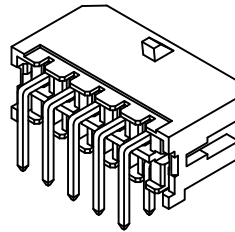
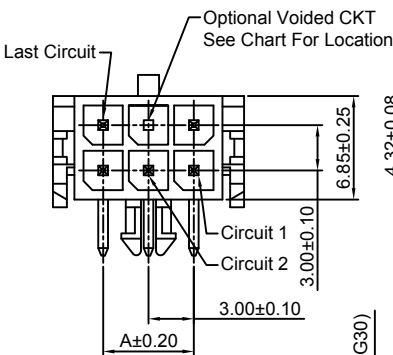

Ordering Information:
C3030WR-2xXP - *** - ***
1 2 3

1. Part No.
2. Material:
(blank) : Nylon 66, UL94V-0
LCP: LCP, UL94V-0
GWT: LCP, UL94V-0, GWT 750°C
3. Finish
(blank) : Tin over Nickel
G: Gold-flash
G15: 15µin (0.38µm) MIN. Select Gold
100µin (2.54µm) MIN. Select Tin
G30: 30µin (0.76µm) MIN. Select Gold
100µin (2.54µm) MIN. Select Tin

Ordering Information & Dimensions:

PART NO.	Dimensions	
	A	B
2x1P	---	6.85
2x2P	3.00	9.85
2x3P	6.00	12.85
2x4P	9.00	15.85
2x5P	12.00	18.85
2x6P	15.00	21.85
2x7P	18.00	24.85
2x8P	21.00	27.85
2x9P	24.00	30.85
2x10P	27.00	33.85
2x11P	30.00	36.85
2x12P	33.00	39.85

Unit: mm

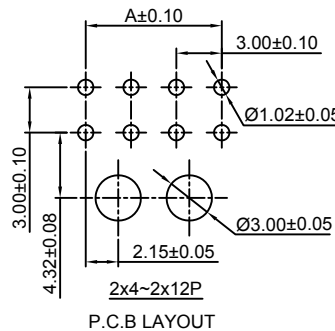
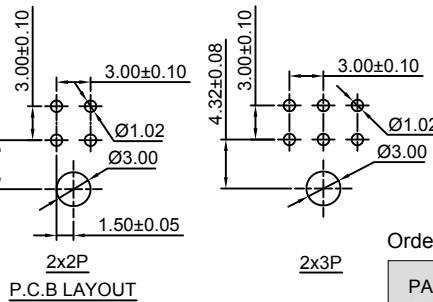
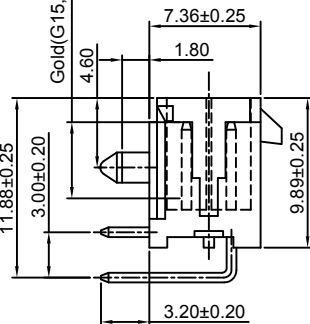
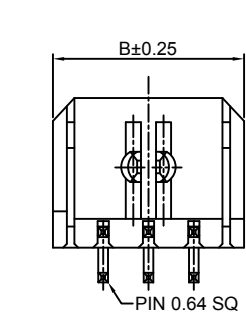

C3030WVC-2xXP

3.00mm pitch Dual Row 180° Compliant Pin Interface Wafer

Reference Informations:

- *Material: Pin: Brass/Tin over Nickel
Insulator: LCP, UL94V-0
- *Mates with CJT C3030HF-2xXP, C3030HF-2xXP-A series Housing
- *Color: Black

Ordering Information:

C3030WVC-2xXP - *** - ***
1 2 3

- Part No.
- Material:
(blank): LCP, UL94V-0
GWT: LCP, UL94V-0, GWT 750 °C
- Finish
(blank): Tin over Nickel
G: Gold-flash
G15: 15µin (0.38µm) MIN. Select Gold
100µin (2.54µm) MIN. Select Tin
G30: 30µin (0.76µm) MIN. Select Gold
100µin (2.54µm) MIN. Select Tin

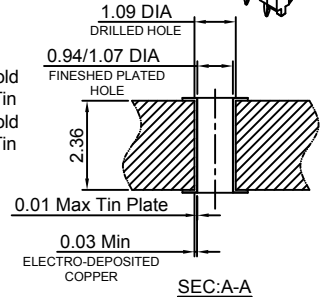
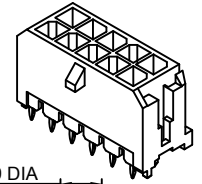

Ordering Information & Dimensions:

PART NO.	Dimensions	
	A	B
2x1P	---	6.65
2x2P	3.00	9.65
2x3P	6.00	12.65
2x4P	9.00	15.65
2x5P	12.00	18.65
2x6P	15.00	21.65
2x7P	18.00	24.65
2x8P	21.00	27.65
2x9P	24.00	30.65
2x10P	27.00	33.65
2x11P	30.00	36.65
2x12P	33.00	39.65

Unit: mm

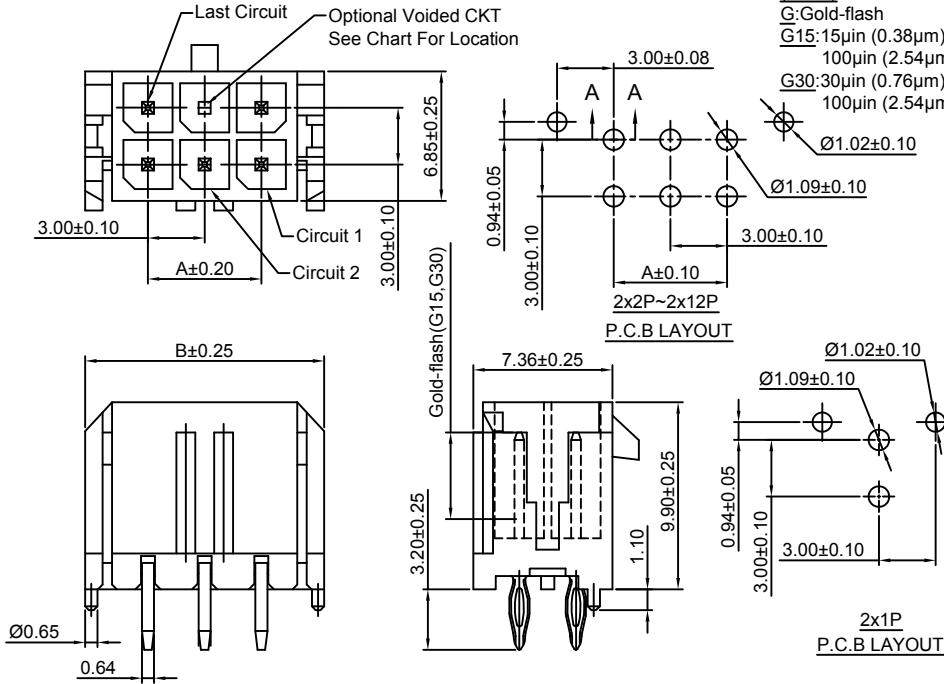

C3030WV-S-2xXP

3.00mm pitch 180° Dual Row Wafer-SMT TYPE

Reference Informations:

- *Material: Pin: Brass/Tin over Nickel
Insulator: LCP, UL94V-0
- *Mates with CJT C3030HF-2xXP, C3030HF-2xXP-A series Housing
- *Color: Black

Ordering Information:

C3030WV-S-2xXP - *** - ***
1 2 3

- Part No.
- Material:
(blank): LCP, UL94V-0
GWT: LCP, UL94V-0, GWT 750 °C
- Finish
(blank): Tin over Nickel
G: Gold-flash
G15: 15µin (0.38µm) MIN. Select Gold
100µin (2.54µm) MIN. Select Tin
G30: 30µin (0.76µm) MIN. Select Gold
100µin (2.54µm) MIN. Select Tin

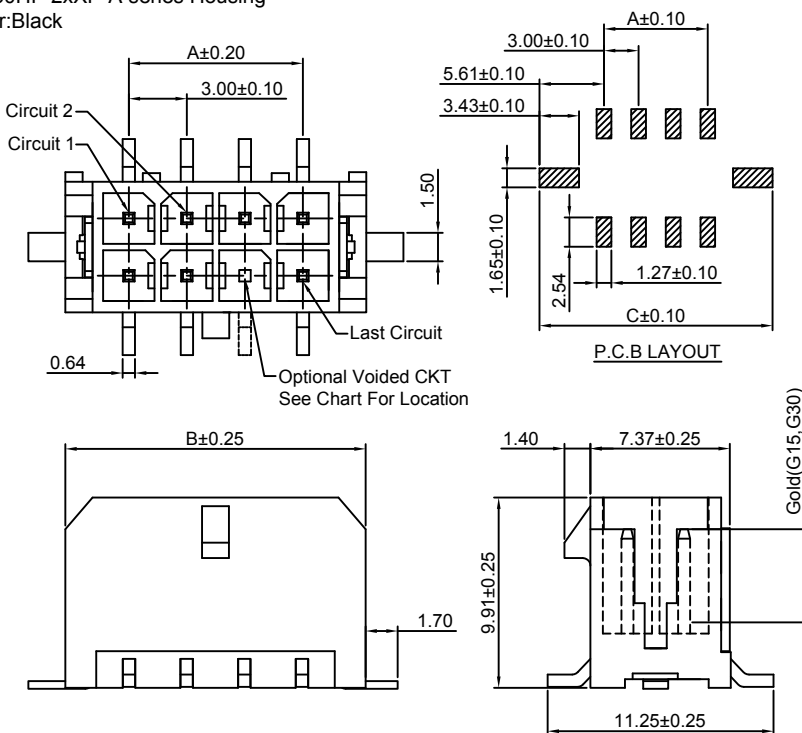
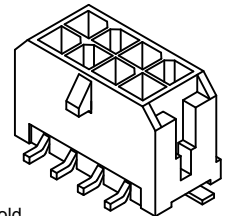

PART NO.	Dimensions		
	A	B	C
2x1P	---	6.65	11.20
2x2P	3.00	9.65	14.20
2x3P	6.00	12.65	17.20
2x4P	9.00	15.65	20.20
2x5P	12.00	18.65	23.20
2x6P	15.00	21.65	26.20
2x7P	18.00	24.65	29.20
2x8P	21.00	27.65	32.20
2x9P	24.00	30.65	35.20
2x10P	27.00	33.65	38.20
2x11P	30.00	36.65	41.20
2x12P	33.00	39.65	44.20

Unit: mm

C3030WR-S-2xXP

3.00mm pitch 90° Dual Row Wafer-SMT TYPE

Reference Informations:

- *Material: Pin: Brass/Tin over Nickel
Insulator: LCP, UL94V-0
- *Mates with CJT C3030HF-2xXP,
C3030HF-2xXP-A series Housing
- *Color: Black

Ordering Information:
C3030WR-S-2xXP - *** - ***
1 2 3

1. Part No.
2. Material:
(blank): LCP, UL94V-0
GWT: LCP, UL94V-0, GWT 750 °C
3. Finish
(blank): Tin over Nickel
G: Gold-flash
G15: 15µin (0.38µm) MIN. Select Gold
100µin (2.54µm) MIN. Select Tin
G30: 30µin (0.76µm) MIN. Select Gold
100µin (2.54µm) MIN. Select Tin

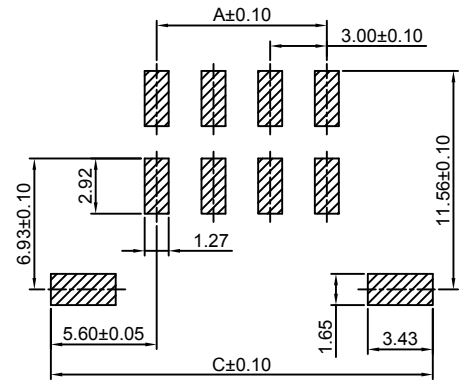
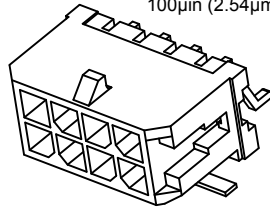
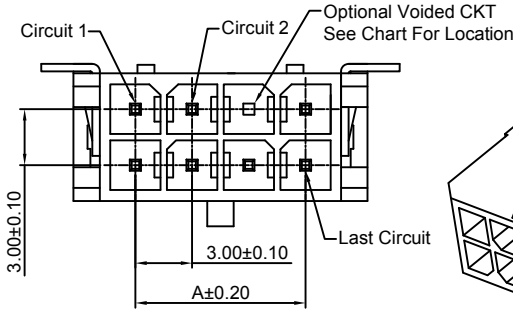

P.C.B LAYOUT

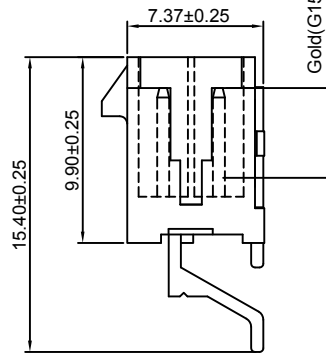
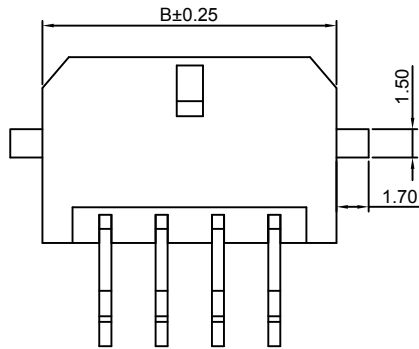

Ordering Information & Dimensions:

PART NO.	Dimensions		
	A	B	C
2x1P	----	6.65	11.20
2x2P	3.00	9.65	14.20
2x3P	6.00	12.65	17.20
2x4P	9.00	15.65	20.20
2x5P	12.00	18.65	23.20
2x6P	15.00	21.65	26.20
2x7P	18.00	24.65	29.20
2x8P	21.00	27.65	32.20
2x9P	24.00	30.65	35.20
2x10P	27.00	33.65	38.20
2x11P	30.00	36.65	41.20
2x12P	33.00	39.65	44.20

Unit: mm

C3030WV-F-2xXP

3.00mm pitch 180° Dual Row Wafer With Foot

Reference Informations:

- *Material: Pin: Brass/Tin over Nickel
Insulator: Nylon 66, UL94V-0
- *Mates with CJT C3030HF-2xXP,
C3030HF-2xXP-A series Housing
- *Color: Black

Ordering Information:
C3030WV-F-2xXP - *** - ***
1 2 3

1. Part No.
2. Material:
(blank): Nylon 66, UL94V-0
LCP: LCP, UL94V-0
GWT: LCP, UL94V-0, GWT 750 °C
3. Finish
(blank): Tin over Nickel
G: Gold-flash
G15: 15µin (0.38µm) MIN. Select Gold
100µin (2.54µm) MIN. Select Tin
G30: 30µin (0.76µm) MIN. Select Gold
100µin (2.54µm) MIN. Select Tin

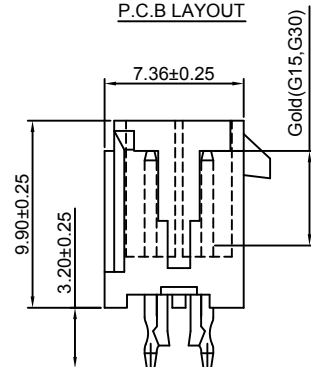
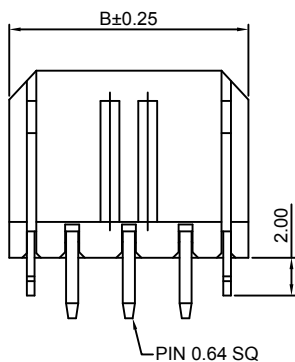
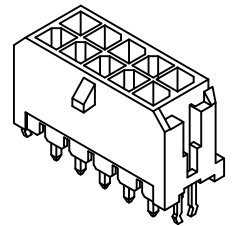
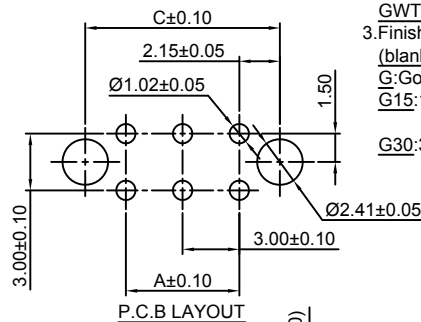
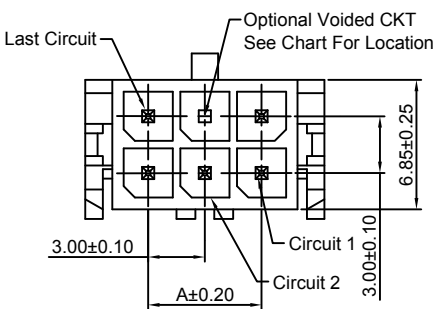

Ordering Information & Dimensions:

PART NO.	Dimensions		
	A	B	C
2x1P	----	6.65	4.30
2x2P	3.00	9.65	7.30
2x3P	6.00	12.65	10.30
2x4P	9.00	15.65	13.30
2x5P	12.00	18.65	16.30
2x6P	15.00	21.65	19.30
2x7P	18.00	24.65	22.30
2x8P	21.00	27.65	25.30
2x9P	24.00	30.65	28.30
2x10P	27.00	33.65	31.30
2x11P	30.00	36.65	34.30
2x12P	33.00	39.65	37.30

Unit: mm

C3030WR-F-2xXP

3.00mm pitch 90° Dual Row Wafer With Foot

Reference Informations:

- *Material: Pin: Brass/Tin over Nickel
Insulator: Nylon 66, UL94V-0
- *Mates with CJT C3030HF-2xXP, C3030HF-2xXP-A series Housing
- *Color: Black

Ordering Information:

C3030WR-F-2xXP - *** - ***
1 2 3

- Part No.
- Material:
(blank): Nylon 66, UL94V-0
LCP: LCP, UL94V-0
GWT: LCP, UL94V-0, GWT 750°C
- Finish
(blank): Tin over Nickel
G: Gold-flash
G15: 15µin (0.38µm) MIN. Select Gold
100µin (2.54µm) MIN. Select Tin
G30: 30µin (0.76µm) MIN. Select Gold
100µin (2.54µm) MIN. Select Tin

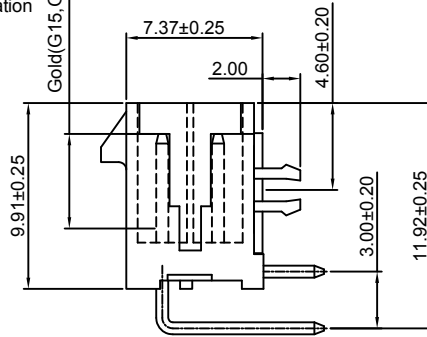
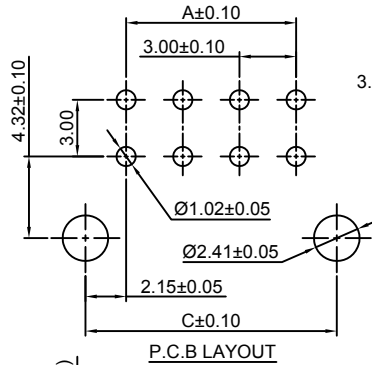
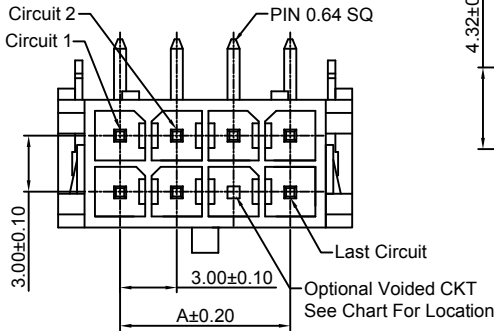
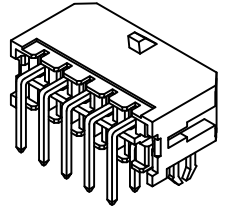

Ordering Information & Dimensions:

PART NO.	Dimensions		
	A	B	C
2x1P	----	6.65	4.30
2x2P	3.00	9.65	7.30
2x3P	6.00	12.65	10.30
2x4P	9.00	15.65	13.30
2x5P	12.00	18.65	16.30
2x6P	15.00	21.65	19.30
2x7P	18.00	24.65	22.30
2x8P	21.00	27.65	25.30
2x9P	24.00	30.65	28.30
2x10P	27.00	33.65	31.30
2x11P	30.00	36.65	34.30
2x12P	33.00	39.65	37.30

Unit: mm

C3030WV-S-F-2xXP

3.00mm pitch 180° Dual Row Wafer-SMT TYPE

Reference Informations:

- *Material: Pin: Brass/Tin over Nickel
Insulator: LCP, UL94V-0
- *Mates with CJT C3030HF-2xXP, C3030HF-2xXP-A series Housing
- *Color: Black

Ordering Information:

C3030WV-S-F-2xXP - *** - ***
1 2 3

- Part No.
- Material:
(blank): LCP, UL94V-0
GWT: LCP, UL94V-0, GWT 750°C
- Finish
(blank): Tin over Nickel
G: Gold-flash
G15: 15µin (0.38µm) MIN. Select Gold
100µin (2.54µm) MIN. Select Tin
G30: 30µin (0.76µm) MIN. Select Gold
100µin (2.54µm) MIN. Select Tin

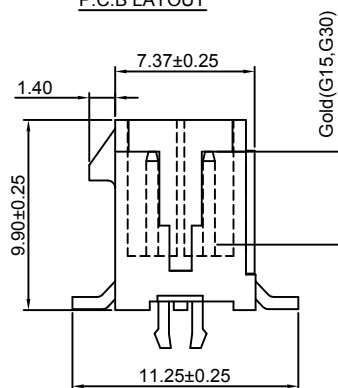
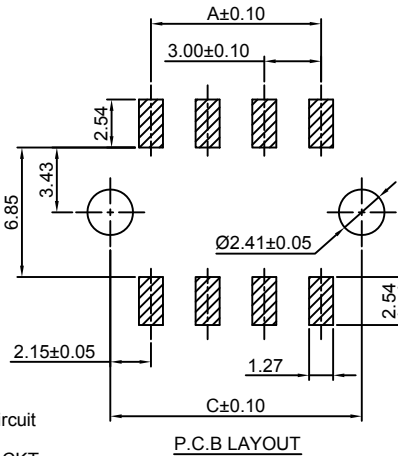
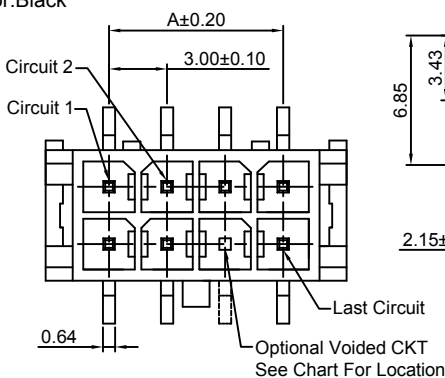
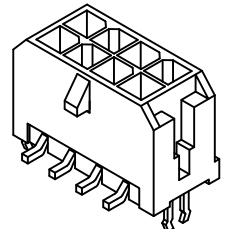

Ordering Information & Dimensions:

PART NO.	Dimensions		
	A	B	C
2x1P	----	6.65	4.30
2x2P	3.00	9.65	7.30
2x3P	6.00	12.65	10.30
2x4P	9.00	15.65	13.30
2x5P	12.00	18.65	16.30
2x6P	15.00	21.65	19.30
2x7P	18.00	24.65	22.30
2x8P	21.00	27.65	25.30
2x9P	24.00	30.65	28.30
2x10P	27.00	33.65	31.30
2x11P	30.00	36.65	34.30
2x12P	33.00	39.65	37.30

Unit: mm

C3030WR-S-F-2xXP

3.00mm pitch 90° Dual Row Wafer-SMT TYPE

Reference Informations:

- *Material: Pin: Brass/Tin over Nickel
Insulator: LCP, UL94V-0
- *Mates with CJT C3030HF-2xXP, C3030HF-2xXP-A series Housing
- *Color: Black

Ordering Information:

C3030WR-S-F-2xXP - *** - ***
1 2 3

1. Part No.
2. Material:
(blank): LCP, UL94V-0
GWT: LCP, UL94V-0, GWT 750 °C
3. Finish
(blank): Tin over Nickel
G: Gold-flash
G15: 15µin (0.38µm) MIN. Select Gold
100µin (2.54µm) MIN. Select Tin
G30: 30µin (0.76µm) MIN. Select Gold
100µin (2.54µm) MIN. Select Tin

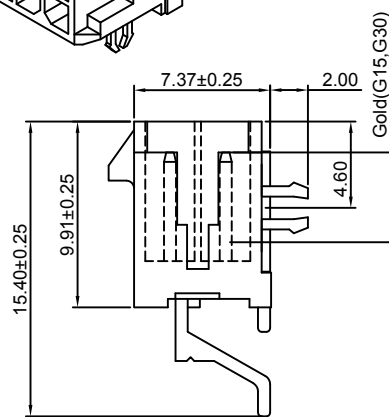
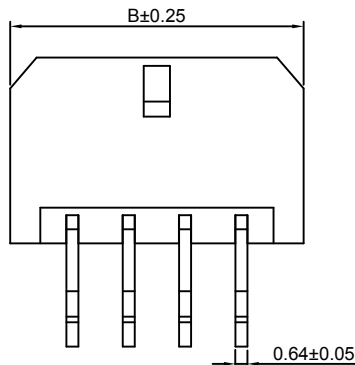
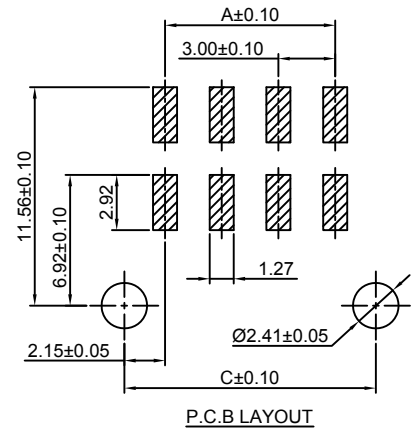
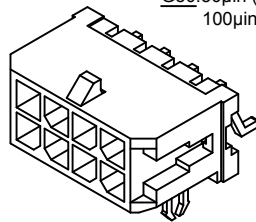
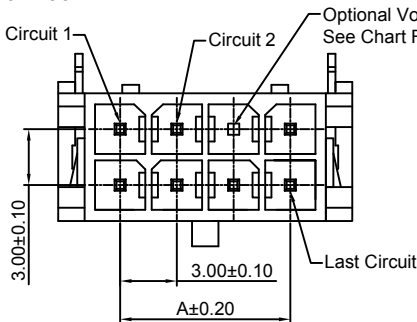

Ordering Information & Dimensions:

PART NO.	Dimensions		
	A	B	C
2x1P	---	6.65	4.30
2x2P	3.00	9.65	7.30
2x3P	6.00	12.65	10.30
2x4P	9.00	15.65	13.30
2x5P	12.00	18.65	16.30
2x6P	15.00	21.65	19.30
2x7P	18.00	24.65	22.30
2x8P	21.00	27.65	25.30
2x9P	24.00	30.65	28.30
2x10P	27.00	33.65	31.30
2x11P	30.00	36.65	34.30
2x12P	33.00	39.65	37.30

Unit: mm

C3030WR-S-F1-2xXP

3.00mm pitch 90° Dual Row Wafer-SMT TYPE

Reference Informations:

- *Material: Pin: Brass/Tin over Nickel
Insulator: LCP, UL94V-0
- *Mates with CJT C3030HF-2xXP, C3030HF-2xXP-A series Housing
- *Color: Black

Ordering Information:
C3030WR-S-F1-2xXP - *** - ***
1 2 3

1. Part No.
2. Material:
(blank): LCP, UL94V-0
GWT: LCP, UL94V-0, GWT 750 °C
3. Finish
(blank): Tin over Nickel
G: Gold-flash
G15: 15µin (0.38µm) MIN. Select Gold
100µin (2.54µm) MIN. Select Tin
G30: 30µin (0.76µm) MIN. Select Gold
100µin (2.54µm) MIN. Select Tin

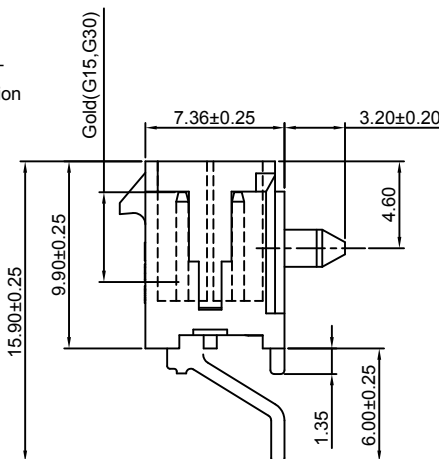
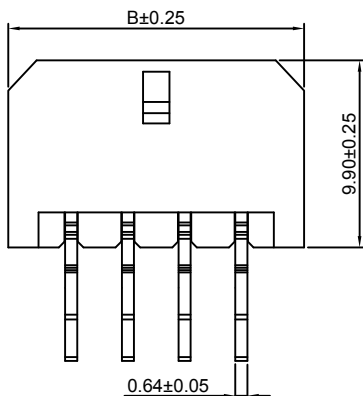
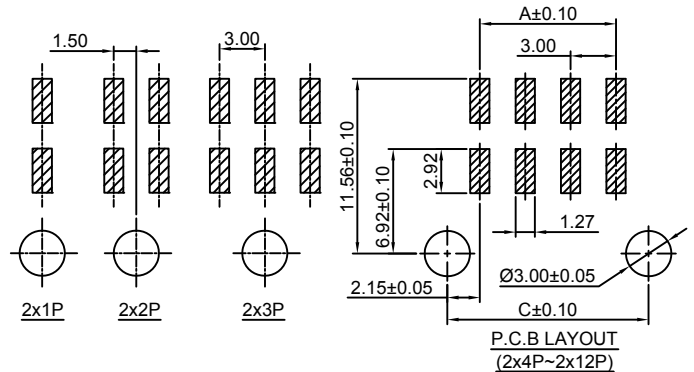
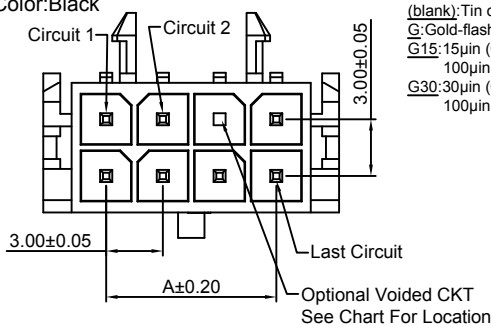

PART NO.	Dimensions		
	A	B	C
2x1P	---	6.65	4.30
2x2P	3.00	9.65	7.30
2x3P	6.00	12.65	10.30
2x4P	9.00	15.65	13.30
2x5P	12.00	18.65	16.30
2x6P	15.00	21.65	19.30
2x7P	18.00	24.65	22.30
2x8P	21.00	27.65	25.30
2x9P	24.00	30.65	28.30
2x10P	27.00	33.65	31.30
2x11P	30.00	36.65	34.30
2x12P	33.00	39.65	37.30

Unit: mm

C3030WVA-2xXP

3.00mm pitch 180° Dual Row Wafer

Reference Informations:

- *Material: Pin: Brass/Tin over Nickel
Insulator: Nylon 66, UL94V-0
- *Mates with CJT C3030HF-2xXP,
C3030HF-2xXP-A series Housing
- *Color: Black

Ordering Information:

C3030WVA-2xXP - ^{*}/₁ - ^{**}/₂ - ^{***}/₃ - ^{****}/₄

1. Part No.
2. Style:
(blank): Type 1
3: Type 3
3. Material:
(blank): Nylon 66, UL94V-0
GWT: Nylon 66, UL94V-0, GWT 750°C
4. Finish:
(blank): Tin over Nickel
G: Gold-flash
G15: 15µin (0.38µm) MIN. Select Gold
100µin (2.54µm) MIN. Select Tin
G30: 30µin (0.76µm) MIN. Select Gold
100µin (2.54µm) MIN. Select Tin

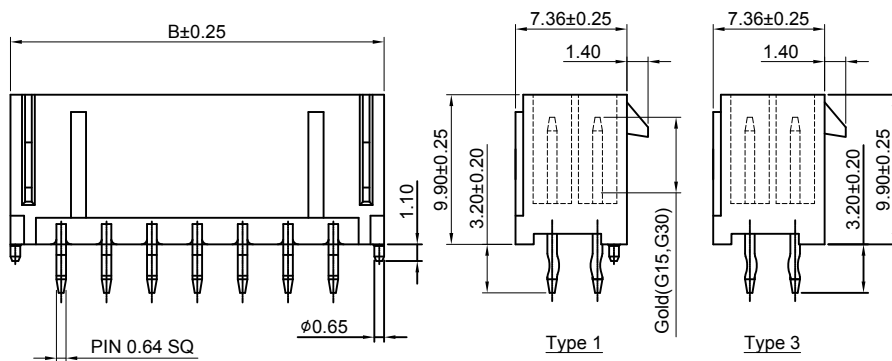
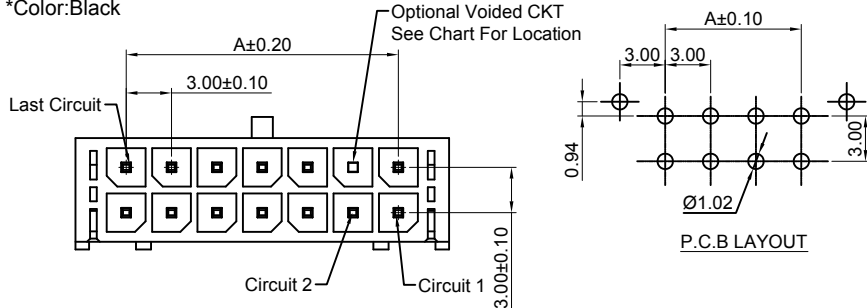
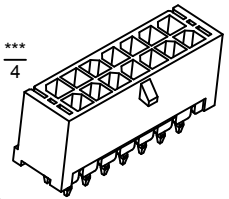

Ordering Information & Dimensions:

PART NO.	Dimensions	
	A	B
2x1P	----	6.70
2x2P	3.00	9.70
2x3P	6.00	12.70
2x4P	9.00	15.70
2x5P	12.00	18.70
2x6P	15.00	21.70
2x7P	18.00	24.70
2x8P	21.00	27.70
2x9P	24.00	30.70
2x10P	27.00	33.70
2x11P	30.00	36.70
2x12P	33.00	39.70

Unit: mm

C3030WVA-S-2xXP

3.00mm pitch 180° Dual Row Wafer - SMT TYPE

Reference Informations:

- *Material: Pin: Brass/Tin over Nickel
Insulator: LCP, UL94V-0
- *Mates with CJT C3030HF-2xXP,
C3030HF-2xXP-A series Housing
- *Color: Black

Ordering Information:

C3030WVA-S-2xXP - ^{*}/₁ - ^{**}/₂ - ^{***}/₃

1. Part No.
2. Material:
(blank): LCP, UL94V-0
GWT: LCP, UL94V-0, GWT 750°C
3. Finish:
(blank): Tin over Nickel
G: Gold-flash
G15: 15µin (0.38µm) MIN. Select Gold
100µin (2.54µm) MIN. Select Tin
G30: 30µin (0.76µm) MIN. Select Gold
100µin (2.54µm) MIN. Select Tin

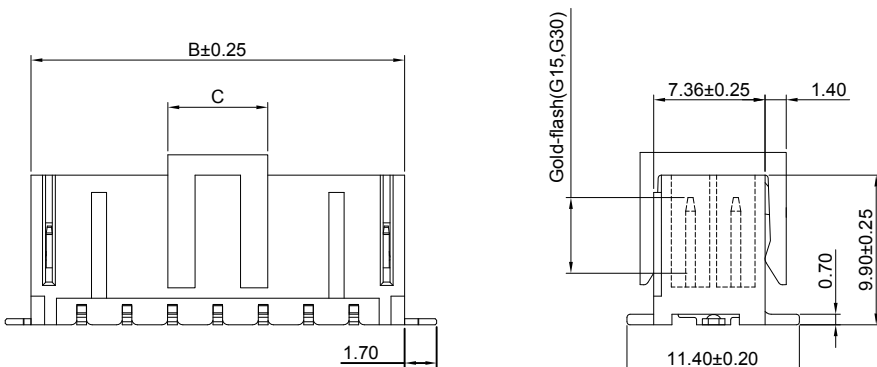
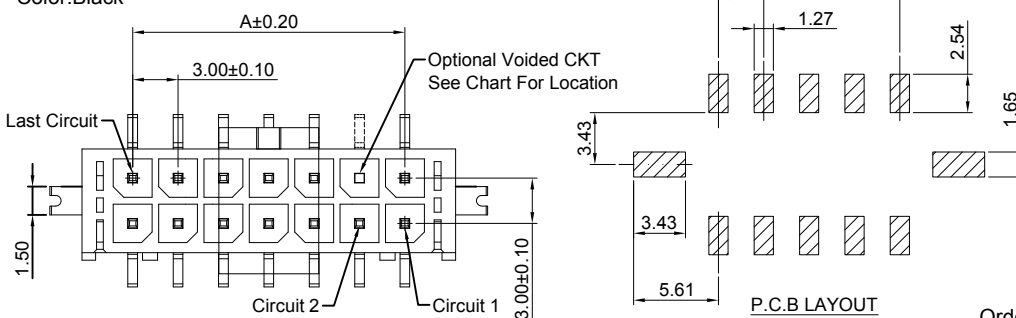

Ordering Information & Dimensions:

PART NO.	Dimensions		
	A	B	C
2x1P	----	6.70	6.60
2x2P	3.00	9.70	6.60
2x3P	6.00	12.70	6.60
2x4P	9.00	15.70	6.60
2x5P	12.00	18.70	6.60
2x6P	15.00	21.70	6.60
2x7P	18.00	24.70	6.60
2x8P	21.00	27.70	12.00
2x9P	24.00	30.70	12.00
2x10P	27.00	33.70	12.00
2x11P	30.00	36.70	12.00
2x12P	33.00	39.70	12.00

Unit: mm

C3030WVA-F-2xXP

3.00mm pitch 180° Dual Row Wafer

Reference Informations:

- *Material: Pin: Brass/Tin over Nickel
Insulator: LCP, UL94V-0
- *Mates with CJT C3030HF-2xXP, C3030HF-2xXP-A series Housing
- *Color: Black

Ordering Information:
C3030WVA-F-2xXP - ^{***}/₂ - ^{***}/₃

- Part No.
- Material:
(blank): LCP, UL94V-0
GWT: LCP, UL94V-0, GWT 750°C
- Finish
(blank): Tin over Nickel
G: Gold-flash
G15: 15µm (0.38µm) MIN. Select Gold
100µm (2.54µm) MIN. Select Tin
G30: 30µm (0.76µm) MIN. Select Gold
100µm (2.54µm) MIN. Select Tin

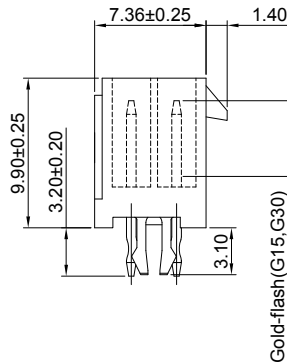
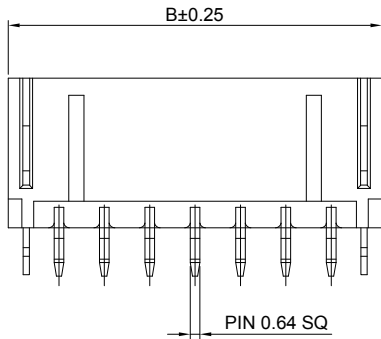
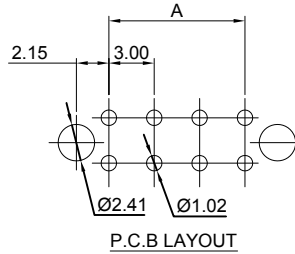
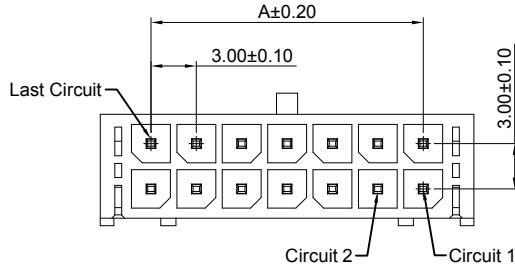

Ordering Information & Dimensions:

PART NO.	Dimensions	
	A	B
2x1P	----	6.70
2x2P	3.00	9.70
2x3P	6.00	12.70
2x4P	9.00	15.70
2x5P	12.00	18.70
2x6P	15.00	21.70
2x7P	18.00	24.70
2x8P	21.00	27.70
2x9P	24.00	30.70
2x10P	27.00	33.70
2x11P	30.00	36.70
2x12P	33.00	39.70

Unit: mm

C3030WVA-S-F-2xXP

3.00mm pitch 180° Dual Row Wafer - SMT TYPE

Reference Informations:

- *Material: Pin: Brass/Tin over Nickel
Insulator: LCP, UL94V-0
- *Mates with CJT C3030HF-2xXP, C3030HF-2xXP-A series Housing
- *Color: Black

Ordering Information:
C3030WVA-S-F-2xXP - ^{***}/₂ - ^{***}/₃

- Part No.
- Material:
(blank): LCP, UL94V-0
GWT: LCP, UL94V-0, GWT 750°C
- Finish
(blank): Tin over Nickel
G: Gold-flash
G15: 15µm (0.38µm) MIN. Select Gold
100µm (2.54µm) MIN. Select Tin
G30: 30µm (0.76µm) MIN. Select Gold
100µm (2.54µm) MIN. Select Tin

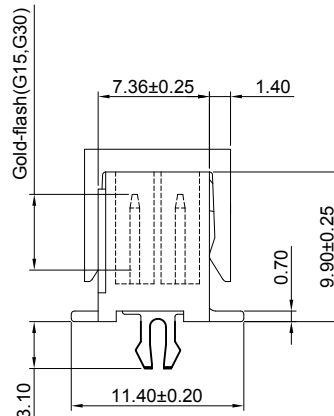
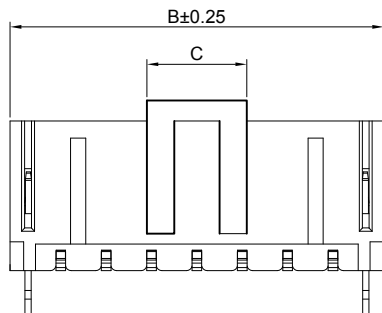
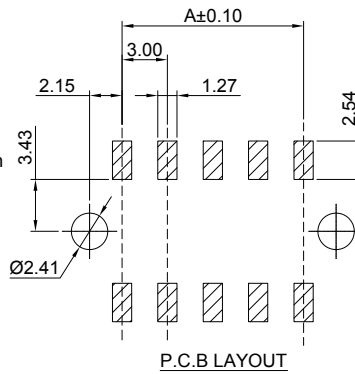
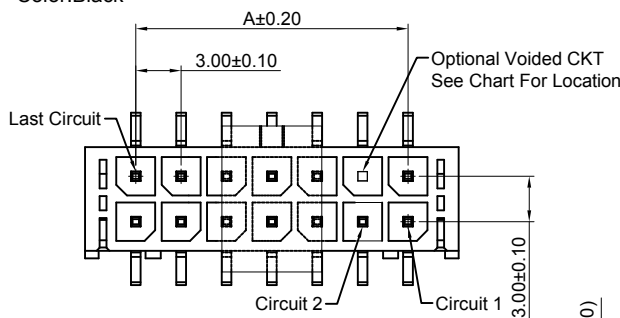

Ordering Information & Dimensions:

PART NO.	Dimensions		
	A	B	C
2x1P	----	6.70	6.60
2x2P	3.00	9.70	6.60
2x3P	6.00	12.70	6.60
2x4P	9.00	15.70	6.60
2x5P	12.00	18.70	6.60
2x6P	15.00	21.70	6.60
2x7P	18.00	24.70	6.60
2x8P	21.00	27.70	12.00
2x9P	24.00	30.70	12.00
2x10P	27.00	33.70	12.00
2x11P	30.00	36.70	12.00
2x12P	33.00	39.70	12.00

Unit: mm

C3030WRA-F-2xXP

3.00mm pitch 90° Dual Row Wafer

Reference Informations:

- *Material: Pin: Brass/Tin over Nickel
Insulator: Nylon 66, UL94V-0
- *Mates with CJT C3030HF-2xXP, C3030HF-2xXP-A series Housing
- *Color: Black

Ordering Information:
C3030WRA-F-2xXP - ^{***}/₂ - ^{***}/₃

1. Part No.
2. Material:
(blank): Nylon 66, UL94V-0
GWT: Nylon 66, UL94V-0, GWT 750°C
3. Finish
(blank): Tin over Nickel
G: Gold-flash
G15: 15µin (0.38µm) MIN. Select Gold
100µin (2.54µm) MIN. Select Tin
G30: 30µin (0.76µm) MIN. Select Gold
100µin (2.54µm) MIN. Select Tin

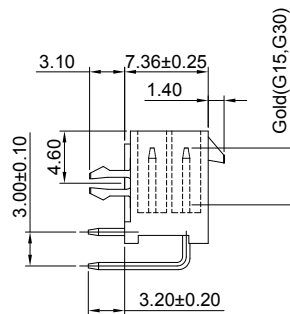
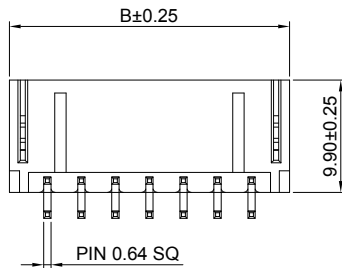
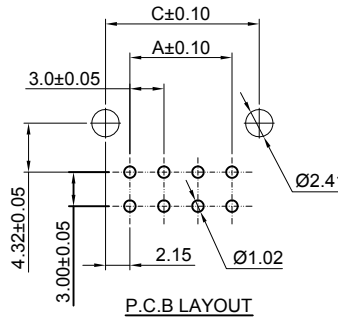
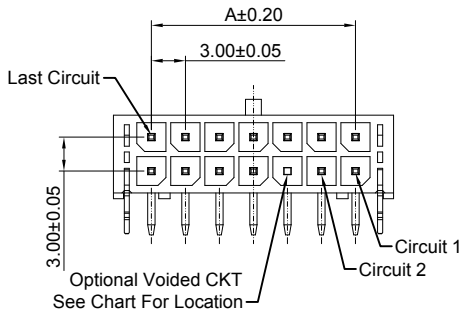

Ordering Information & Dimensions:

PART NO.	Dimensions		
	A	B	C
2x1P	----	6.65	4.30
2x2P	3.00	9.65	7.30
2x3P	6.00	12.65	10.30
2x4P	9.00	15.65	13.30
2x5P	12.00	18.65	16.30
2x6P	15.00	21.65	19.30
2x7P	18.00	24.65	22.30
2x8P	21.00	27.65	25.30
2x9P	24.00	30.65	28.30
2x10P	27.00	33.65	31.30
2x11P	30.00	36.65	34.30
2x12P	33.00	39.65	37.30

Unit: mm

C3030WRA-F1-2xXP

3.00mm pitch 90° Dual Row Wafer

Reference Informations:

- *Material: Pin: Brass/Tin over Nickel
Insulator: Nylon 66, UL94V-0
- *Mates with CJT C3030HF-2xXP, C3030HF-2xXP-A series Housing
- *Color: Black

Ordering Information:
C3030WRA-F1-2xXP - ^{***}/₂ - ^{***}/₃

1. Part No.
2. Material:
(blank): Nylon 66, UL94V-0
GWT: Nylon 66, UL94V-0, GWT 750°C
3. Finish
(blank): Tin over Nickel
G: Gold-flash
G15: 15µin (0.38µm) MIN. Select Gold
100µin (2.54µm) MIN. Select Tin
G30: 30µin (0.76µm) MIN. Select Gold
100µin (2.54µm) MIN. Select Tin

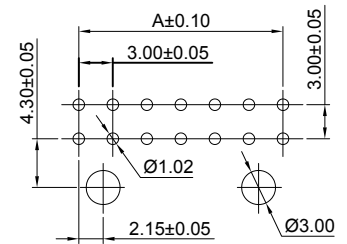
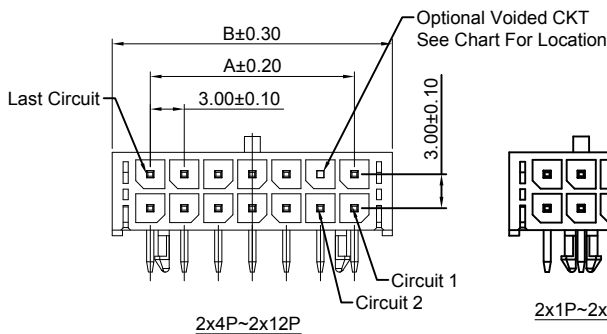

P.C.B LAYOUT
2x4P~2x12P

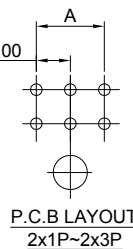
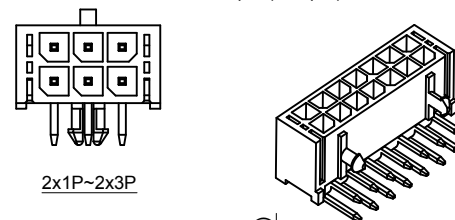
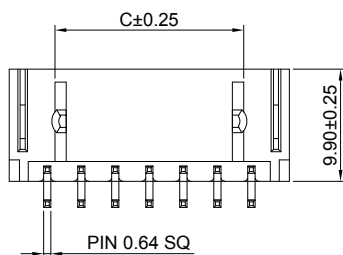

P.C.B LAYOUT
2x1P~2x3P

Ordering Information & Dimensions:

PART NO.	Dimensions		
	A	B	C
2x1P	----	6.65	2.90
2x2P	3.00	9.65	2.90
2x3P	6.00	12.65	2.90
2x4P	9.00	15.65	7.60
2x5P	12.00	18.65	10.60
2x6P	15.00	21.65	13.60
2x7P	18.00	24.65	16.60
2x8P	21.00	27.65	19.60
2x9P	24.00	30.65	22.60
2x10P	27.00	33.65	25.60
2x11P	30.00	36.65	28.60
2x12P	33.00	39.65	31.60

Unit: mm

C3030WRA-S-2xXP

3.00mm pitch 90° Dual Row Wafer - SMT TYPE

Reference Informations:

- *Material: Pin: Brass/Tin over Nickel
Insulator: LCP, UL94V-0
- *Mates with CJT C3030HF-2xXP, C3030HF-2xXP-A series Housing
- *Color: Black

Ordering Information:

C3030WRA-S-2xXP - *** - ***
1 2 3

- Part No.
- Material:
(blank): LCP, UL94V-0
GWT: LCP, UL94V-0, GWT 750°C
- Finish
(blank): Tin over Nickel
G: Gold-flash
G15: 15µm (0.38µm) MIN. Select Gold
100µm (2.54µm) MIN. Select Tin
G30: 30µm (0.76µm) MIN. Select Gold
100µm (2.54µm) MIN. Select Tin

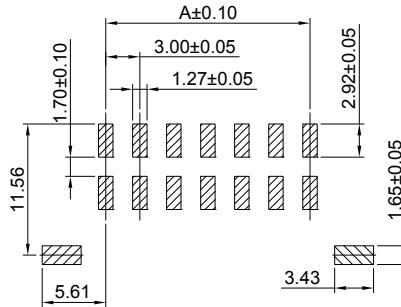
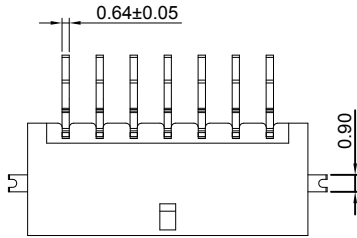

P.C.B LAYOUT

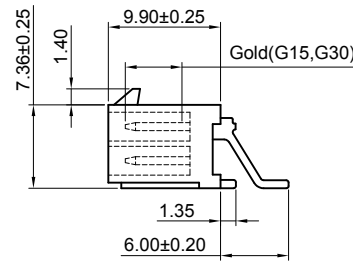
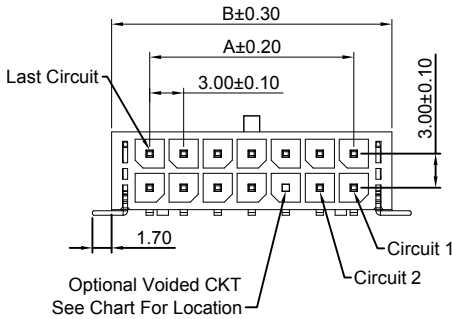

Ordering Information & Dimensions:

PART NO.	Dimensions	
	A	B
2x1P	----	6.70
2x2P	3.00	9.70
2x3P	6.00	12.70
2x4P	9.00	15.70
2x5P	12.00	18.70
2x6P	15.00	21.70
2x7P	18.00	24.70
2x8P	21.00	27.70
2x9P	24.00	30.70
2x10P	27.00	33.70
2x11P	30.00	36.70
2x12P	33.00	39.70

Unit: mm

C3030WRA-S-F-2xXP

3.00mm pitch 90° Dual Row Wafer - SMT TYPE

Reference Informations:

- *Material: Pin: Brass/Tin over Nickel
Insulator: LCP, UL94V-0
- *Mates with CJT C3030HF-2xXP, C3030HF-2xXP-A series Housing
- *Color: Black

Ordering Information:

C3030WRA-S-F-2xXP - *** - ***
1 2 3

- Part No.
- Material:
(blank): LCP, UL94V-0
GWT: LCP, UL94V-0, GWT 750°C
- Finish
(blank): Tin over Nickel
G: Gold-flash
G15: 15µm (0.38µm) MIN. Select Gold
100µm (2.54µm) MIN. Select Tin
G30: 30µm (0.76µm) MIN. Select Gold
100µm (2.54µm) MIN. Select Tin

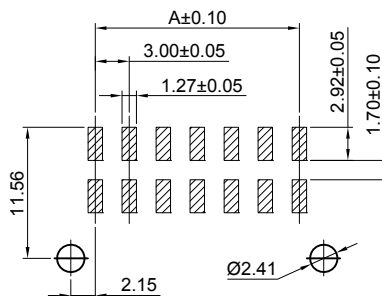
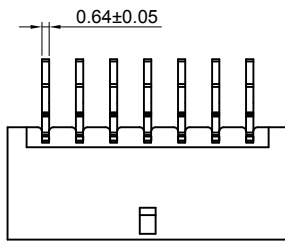

P.C.B LAYOUT

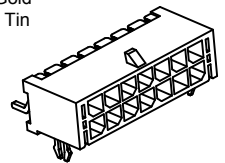
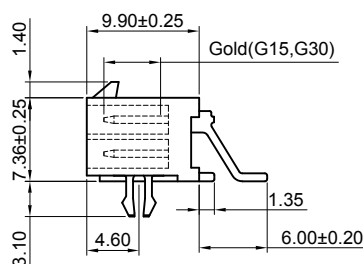
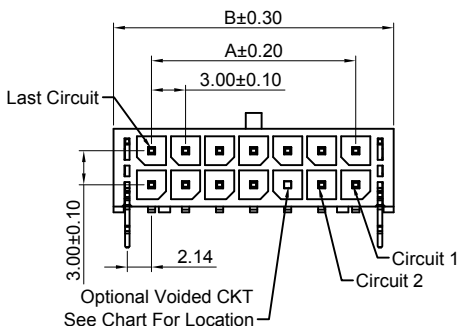

Ordering Information & Dimensions:

PART NO.	Dimensions	
	A	B
2x1P	----	6.70
2x2P	3.00	9.70
2x3P	6.00	12.70
2x4P	9.00	15.70
2x5P	12.00	18.70
2x6P	15.00	21.70
2x7P	18.00	24.70
2x8P	21.00	27.70
2x9P	24.00	30.70
2x10P	27.00	33.70
2x11P	30.00	36.70
2x12P	33.00	39.70

Unit: mm

C3030WRA-S-F1-2xXP

3.00mm pitch 90° Dual Row Wafer - SMT TYPE

Reference Informations:

- *Material: Pin: Brass/Tin over Nickel
Insulator: LCP, UL94V-0
- *Mates with CJT C3030HF-2xXP, C3030HF-2xXP-A series Housing
- *Color: Black

Ordering Information:

C3030WRA-S-F1-2xXP - *** - ***
1 2 3

1. Part No.
2. Material:
(blank): LCP, UL94V-0
GWT: LCP, UL94V-0, GWT 750°C
3. Finish
(blank): Tin over Nickel
G: Gold-flash
G15: 15µin (0.38µm) MIN. Select Gold
100µin (2.54µm) MIN. Select Tin
G30: 30µin (0.76µm) MIN. Select Gold
100µin (2.54µm) MIN. Select Tin

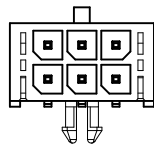
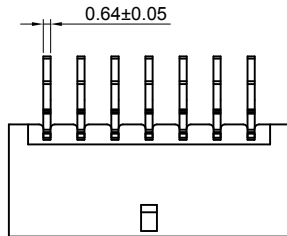

2x1P~2x3P

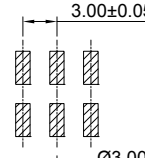

P.C.B LAYOUT
(2x1P~2x3P)

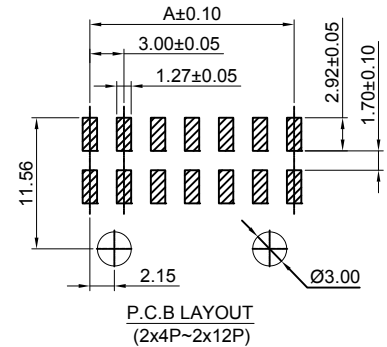

P.C.B LAYOUT
(2x4P~2x12P)

Ordering Information & Dimensions:

PART NO.	Dimensions	
	A	B
2x1P	---	6.70
2x2P	3.00	9.70
2x3P	6.00	12.70
2x4P	9.00	15.70
2x5P	12.00	18.70
2x6P	15.00	21.70
2x7P	18.00	24.70
2x8P	21.00	27.70
2x9P	24.00	30.70
2x10P	27.00	33.70
2x11P	30.00	36.70
2x12P	33.00	39.70

Unit: mm

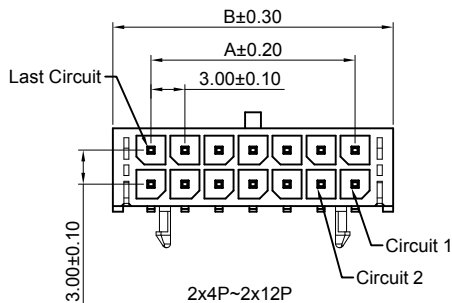

2x4P~2x12P

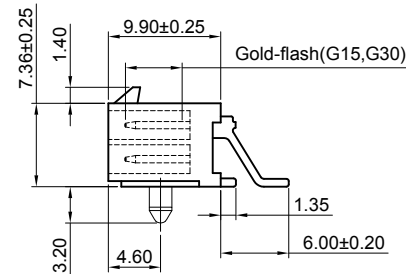

C3030HFWV-2xXP

3.00mm pitch Dual Row Receptacle Header

Reference Informations:

- *Material: LCP, UL94V-0
- *Mates with CJT C3030HMB-2xXP series Housing or C3030WVB, WRB-2xXP Series Wafer
- *Color: Black

Ordering Information:

C3030HFWV-2xXP - *** - ***
1 2 3

1. Part No.
2. Material:
(blank): LCP, UL94V-0
GWT: LCP, UL94V-0, GWT 750°C
3. Finish:
(blank): Tin over Nickel
G: Gold-flash
G15: 15µin (0.38µm) MIN. Select Gold
100µin (2.54µm) MIN. Select Tin
G30: 30µin (0.76µm) MIN. Select Gold
100µin (2.54µm) MIN. Select Tin

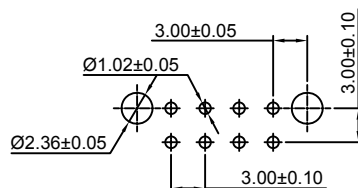
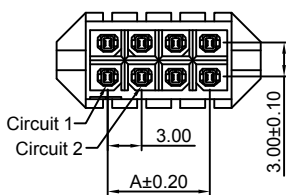

P.C.B LAYOUT

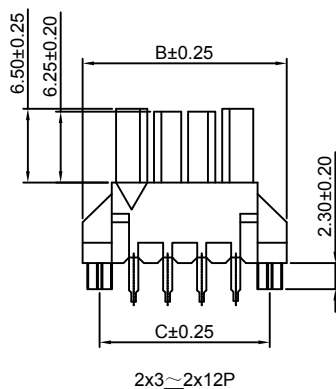
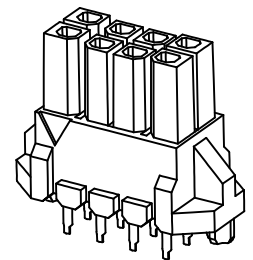

2x3~2x12P

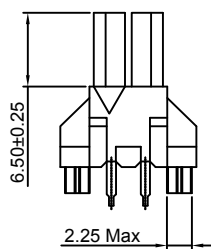

2x2P

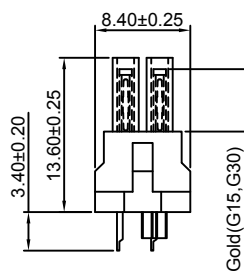

Ordering Information & Dimensions:

PART NO.	Dimensions		
	A	B	C
2x2P	3.00	12.00	9.00
2x3P	6.00	15.00	12.00
2x4P	9.00	18.00	15.00
2x5P	12.00	21.00	18.00
2x6P	15.00	24.00	21.00
2x7P	18.00	27.00	24.00
2x8P	21.00	30.00	27.00
2x9P	24.00	33.00	30.00
2x10P	27.00	36.00	33.00
2x11P	30.00	39.00	36.00
2x12P	33.00	42.00	39.00

Unit: mm

C3030HFWR-2xXP

3.00mm pitch Dual Row Receptacle Header

Reference Informations:

- *Material:LCP,UL94V-0
- *Mates with CJT C3030HMB-2xXP series Housing or C3030WVB,WRB-2xXP Series Wafer
- *Color:Black

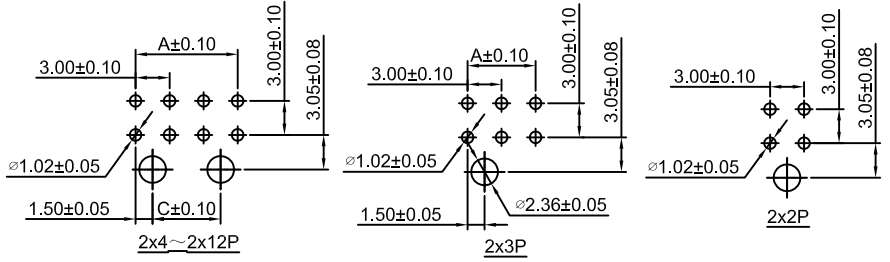

Ordering Information:

C3030HFWR-2xXP - *** - ***
1 2 3

- Part No.
- Material:
(blank):LCP,UL94V-0
GWT:LCP,UL94V-0,GWT 750°C
- Finish:
(blank):Tin over Nickel
G:Gold-flash
G15:15µin (0.38µm) MIN.Select Gold
100µin (2.54µm) MIN.Select Tin
G30:30µin (0.76µm) MIN.Select Gold
100µin (2.54µm) MIN.Select Tin

P.C.B LAYOUT

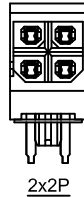
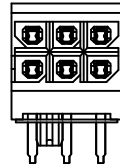
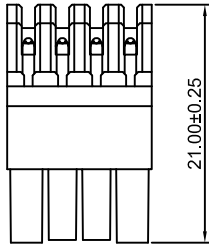
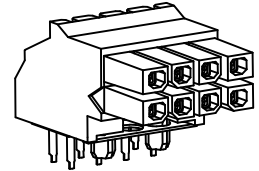

Ordering Information & Dimensions:

PART NO.	Dimensions		
	A	B	C
2x2P	3.00	6.70	----
2x3P	6.00	9.70	----
2x4P	9.00	12.70	6.00
2x5P	12.00	15.70	9.00
2x6P	15.00	18.70	12.00
2x7P	18.00	21.70	15.00
2x8P	21.00	24.70	18.00
2x9P	24.00	27.70	21.00
2x10P	27.00	30.70	24.00
2x11P	30.00	33.70	27.00
2x12P	33.00	36.70	30.00

Unit: mm

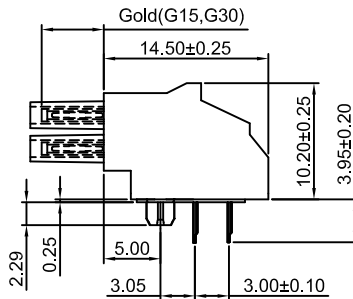
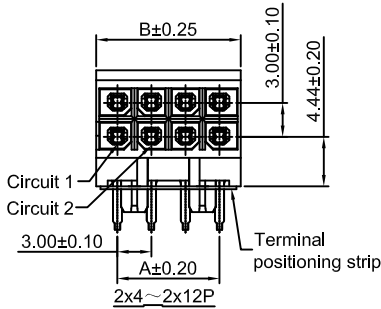

C3030WVB-2xXP

3.00mm pitch Dual Row 180° Wafer

Reference Informations:

- *Material:Pin:Brass/Tin over Nickel
Insulator:LCP,UL94-V0
- *Mates with CJT C3030HFB-2xXP Series Housing or C3030HFVW,HFWR-2xXP Receptacle Header
- *Color:Black

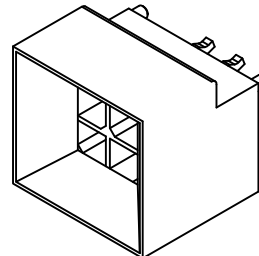

Ordering Information:

C3030WVB-2xXP - *** - ***
1 2 3

- Part No.
- Material:
(blank): LCP,UL94V-0
6T: Nylon 6T,UL94V-0
9T: Nylon 9T,UL94V-0
- Finish:
(blank): Tin over Nickel
G: Gold-flash
G15: 15µin (0.38µm) MIN.Select Gold
100µin (2.54µm) MIN.Select Tin
G30: 30µin (0.76µm) MIN.Select Gold
100µin (2.54µm) MIN.Select Tin

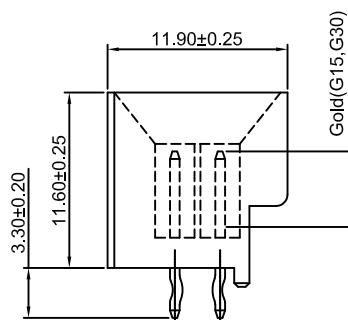
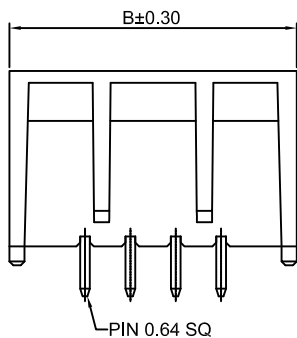
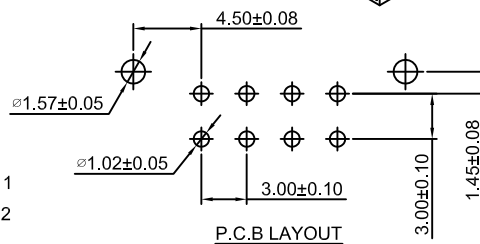
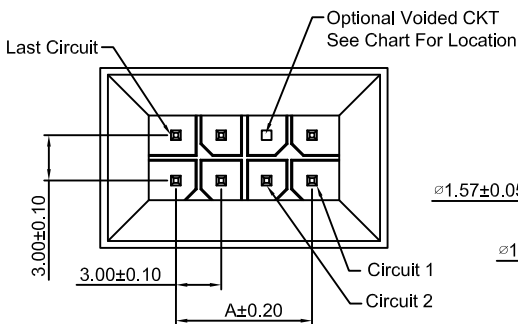

Ordering Information & Dimensions:

PART NO.	Dimensions	
	A	B
2x2P	3.00	13.00
2x3P	6.00	16.00
2x4P	9.00	19.00
2x5P	12.00	22.00
2x6P	15.00	25.00
2x7P	18.00	28.00
2x8P	21.00	31.00
2x9P	24.00	34.00
2x10P	27.00	37.00
2x11P	30.00	40.00
2x12P	33.00	43.00

Unit: mm

C3030WRB-2xXP

3.00mm pitch Dual Row 90° Wafer

Reference Informations:

- *Material:Pin:Brass/Tin over Nickel
Terminal positioning strip:Mylar(Natural)
Insulator:LCP,UL94V-0
- *Mates with CJT C3030HFB-2xXP Series Housing
or C3030HFWV,HFWR-2xXP Receptacle Header
- *Color:Black

Ordering Information:

 C3030WRB-2xXP - *** - ***
 1 2 3

1.Part No.

2.Material:

(blank):LCP,UL94V-0

6T: Nylon 6T,UL94V-0

9T: Nylon 9T,UL94V-0

3.Finish

(blank):Tin over Nickel

G:Gold-flash

G15:15μin (0.38μm) MIN.Select Gold

100μin (2.54μm) MIN.Select Tin

G30:30μin (0.76μm) MIN.Select Gold

100μin (2.54μm) MIN.Select Tin

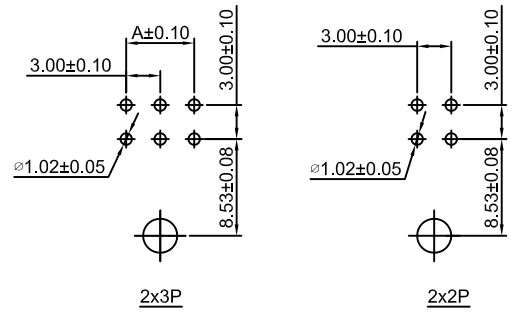
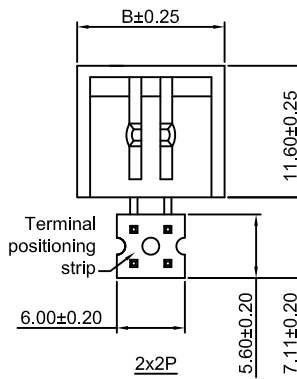
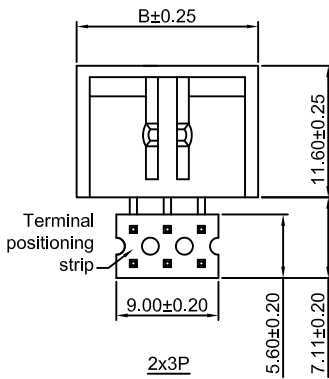
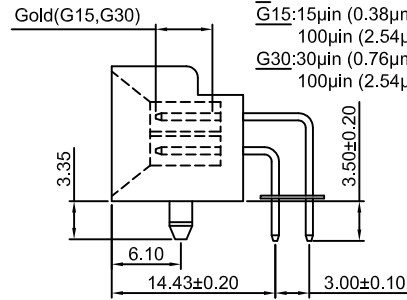
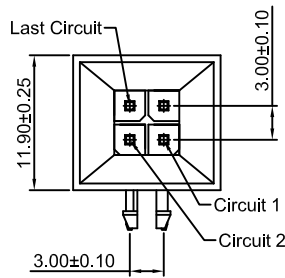
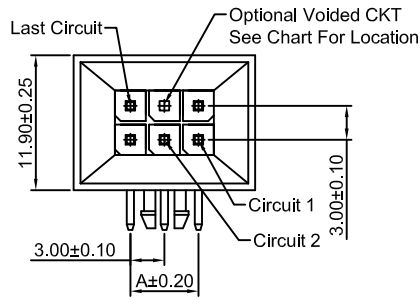
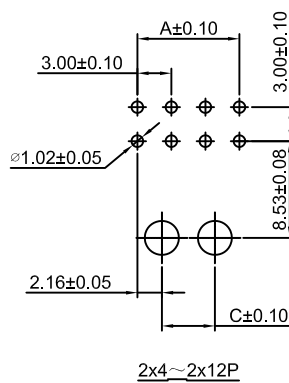
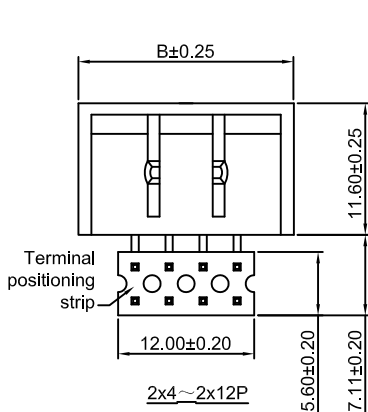
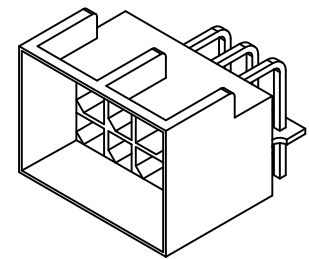
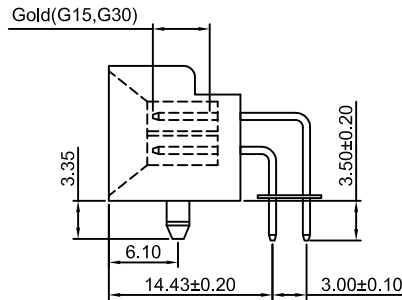
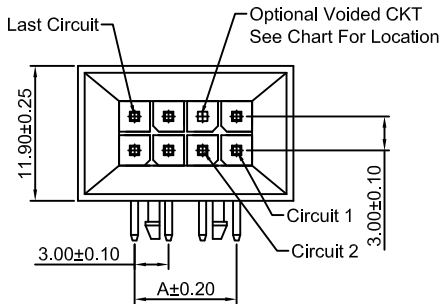
P.C.B LAYOUT

P.C.B LAYOUT
Ordering Information & Dimensions:

PART NO.	Dimensions		
	A	B	C
2x2P	3.00	13.00	----
2x3P	6.00	16.00	----
2x4P	9.00	19.00	4.68
2x5P	12.00	22.00	7.68
2x6P	15.00	25.00	10.68
2x7P	18.00	28.00	13.68
2x8P	21.00	31.00	16.68
2x9P	24.00	34.00	19.68
2x10P	27.00	37.00	22.68
2x11P	30.00	40.00	25.68
2x12P	33.00	43.00	28.68

Unit: mm

X-ON Electronics

Largest Supplier of Electrical and Electronic Components

Click to view similar products for [Headers & Wire Housings](#) category:

Click to view products by [Changjiang](#) manufacturer:

Other Similar products are found below :

[57102-F02-18ULF](#) [58102-G61-06LF](#) [582553-1](#) [009176003701906](#) [0050291907](#) [02.125.8002.8](#) [609-3404](#) [61062-3](#) [622-0430](#) [622-3653LF](#)
[63453-116](#) [636-1030](#) [636-1427](#) [636-3427](#) [636-4007](#) [641938-9](#) [65495-038](#) [65692-001LF](#) [65781-018](#) [65781-047](#) [65817-010LF](#) [65817-015LF](#)
[66207-023LF](#) [67016-026LF](#) [67095-007LF](#) [68631-112](#) [68645-018](#) [68648-049](#) [699319-000](#) [M90C108951C](#) [70.362.1628.0](#) [70-4210](#) [70-4226B](#)
[70-4853B](#) [707-5020](#) [707-5028](#) [71.350.2428.0](#) [71961-016LF](#) [733-134](#) [754199-000](#) [760-3052](#) [787-8014-00](#) [FCN-367T-T012/H](#)
[80.063.4001.1](#) [800-90-001-10-001000](#) [801-43-002-10-013000](#) [801-43-006-10-002000](#) [803-41-018-10-001000](#) [803-43-014-20-001000](#)
[803-43-024-10-001000](#)