

## Specifications

- Current rating: 9A AC, DC Max
- Voltage rating: 600V AC, DC
- Temperature range: -40°C ~ +105°C
- Contact resistance: 10mΩ Max.
- Insulation resistance: 1000MΩ Min.
- Withstanding voltage: 1500V AC/minute
- \*Compliant with RoHS and REACH\*
- \*Meet the HF/Halogen Free, GWT/Glow wire Test (IEC60335-1) request, need to customize\*
- \*Contact CJT for details\*

## Standards



## Panel hole layout

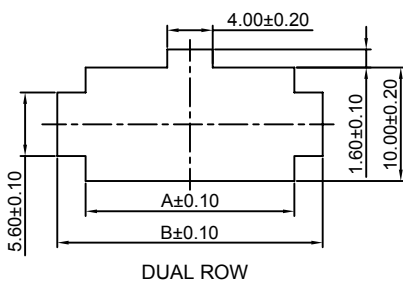

DUAL ROW

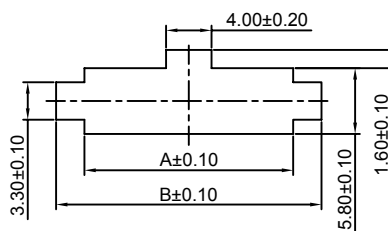

SINGLE ROW

| PART NO.    |               | Dimensions |       |
|-------------|---------------|------------|-------|
| SINGLE ROW  | DUAL ROW      | A          | B     |
| -----       | C4201HM-2x1P  | 5.80       | 10.80 |
| C4201HM-2P  | C4201HM-2x2P  | 10.00      | 15.00 |
| C4201HM-3P  | C4201HM-2x3P  | 14.20      | 19.20 |
| C4201HM-4P  | C4201HM-2x4P  | 18.40      | 23.40 |
| C4201HM-5P  | C4201HM-2x5P  | 22.60      | 27.60 |
| C4201HM-6P  | C4201HM-2x6P  | 26.80      | 31.80 |
| C4201HM-7P  | C4201HM-2x7P  | 31.00      | 36.00 |
| C4201HM-8P  | C4201HM-2x8P  | 35.20      | 40.20 |
| C4201HM-9P  | C4201HM-2x9P  | 39.40      | 44.40 |
| C4201HM-10P | C4201HM-2x10P | 43.60      | 48.60 |
| C4201HM-11P | C4201HM-2x11P | 47.80      | 52.80 |
| C4201HM-12P | C4201HM-2x12P | 52.00      | 57.00 |

Unit:mm

# Assembly layout

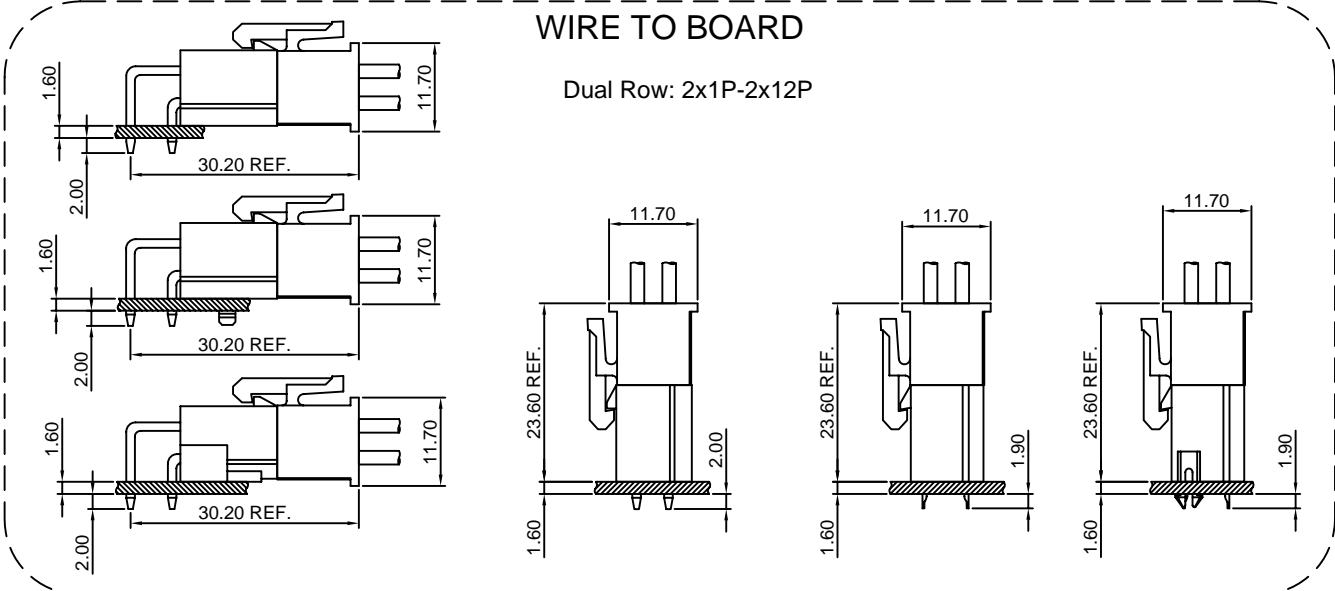
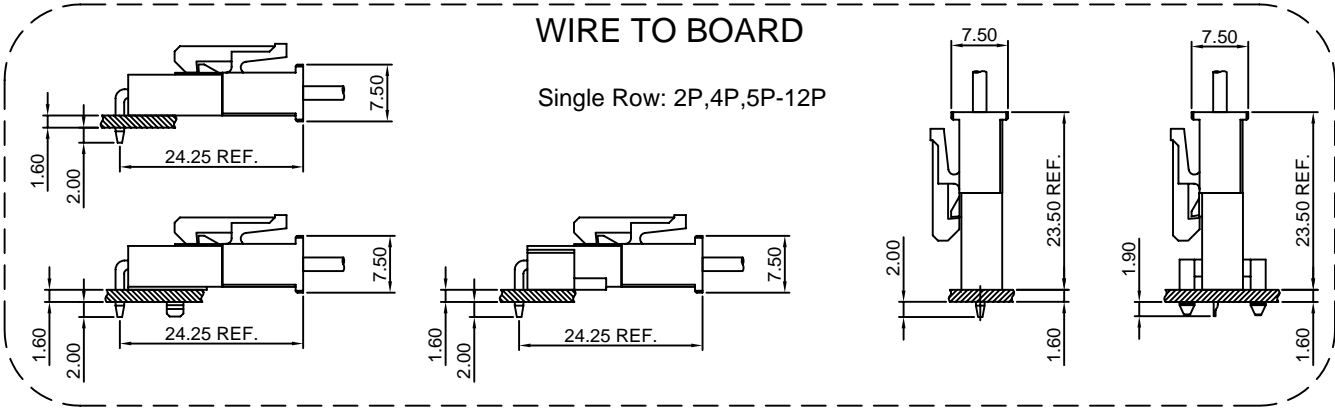
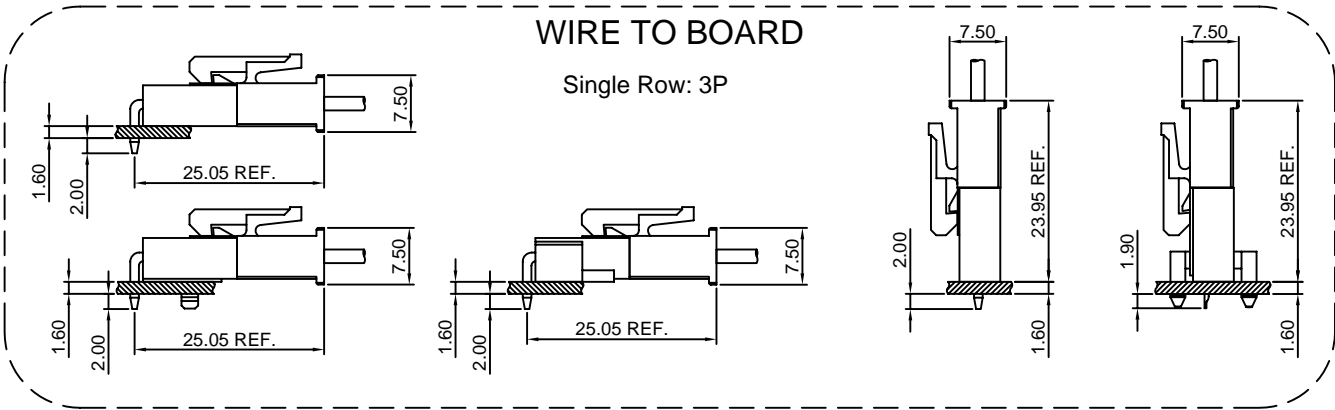
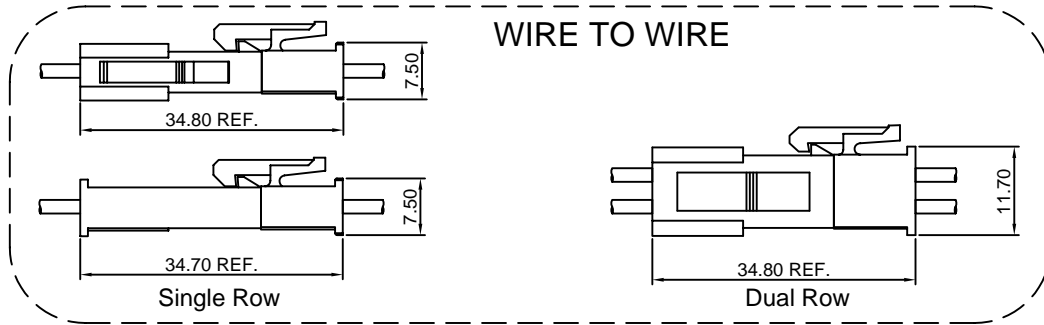

## C4201HF

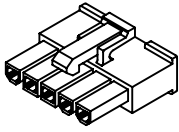

C4201HF

## C4201HM

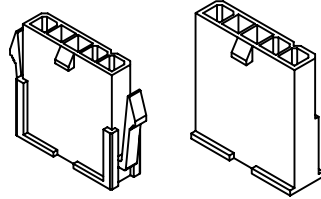

C4201HM

C4201HMA

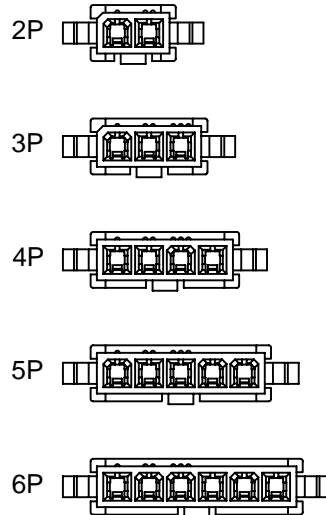
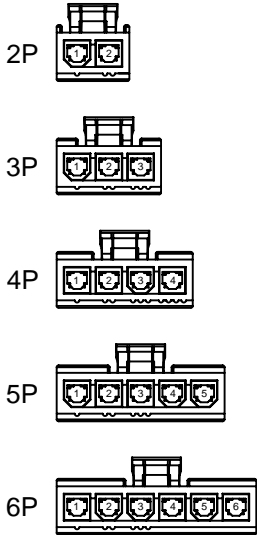

## C4201WV C4201WVA-F

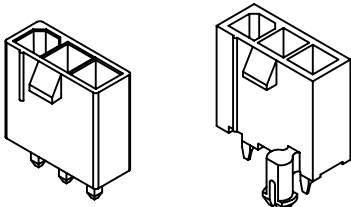

C4201WV

C4201WVA-F

## C4201WR C4201WR-E

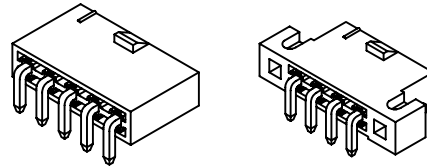

C4201WR

C4201WR-E

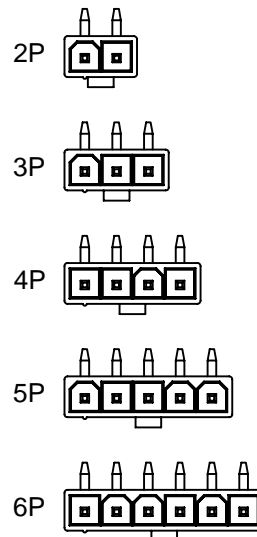
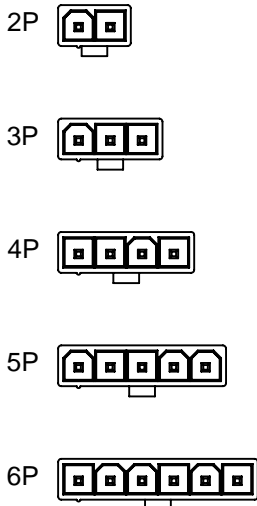

## C4201HF-2

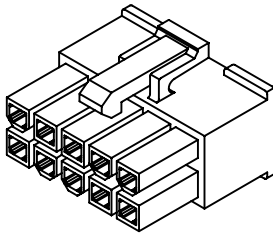

C4201HF-2

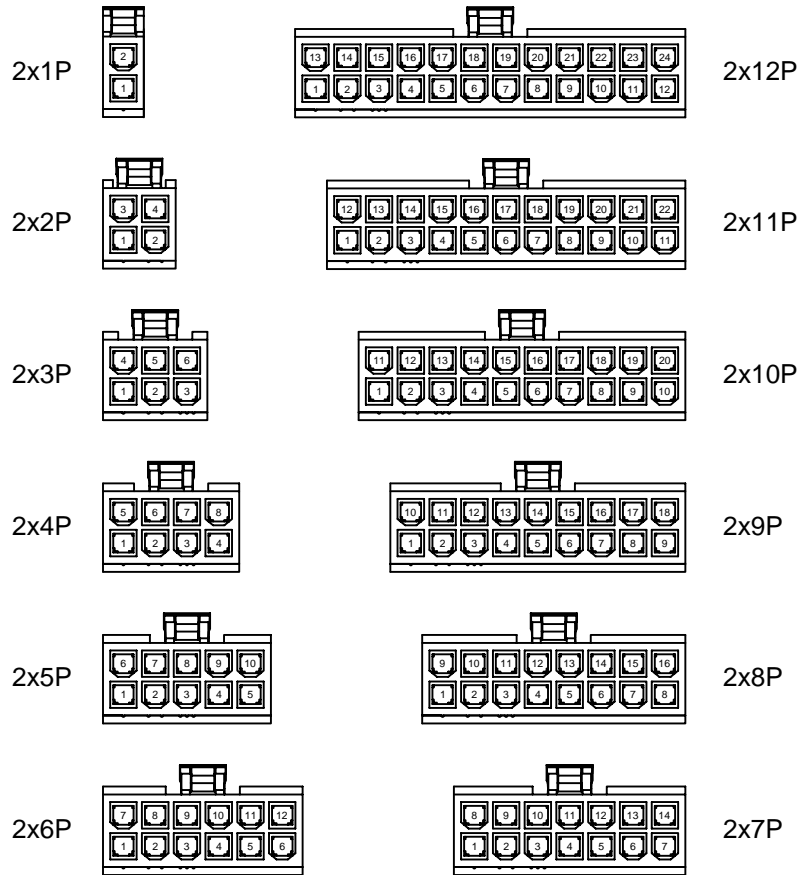

## C4201HM-2 C4201HMA-2

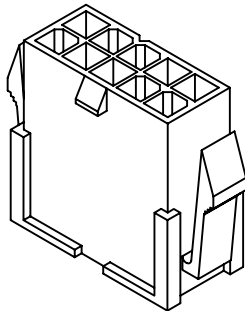

C4201HM-2

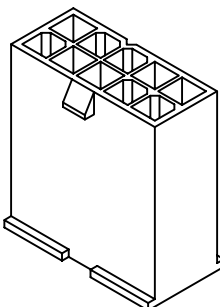

C4201HMA-2

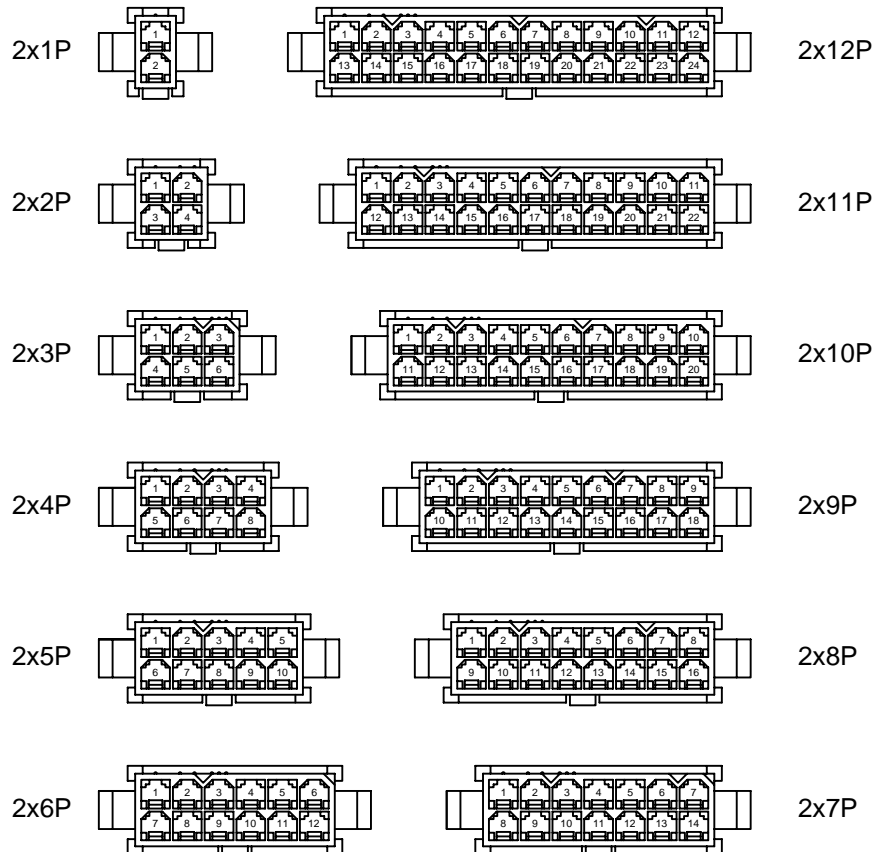

C4201WV-2 C4201WVA-2 C4201WVA-F-2

|              |  |      |  |  |       |
|--------------|--|------|--|--|-------|
| C4201WV-2    |  | 2x1P |  |  | 2x12P |
|              |  | 2x2P |  |  | 2x11P |
| C4201WVA-2   |  | 2x3P |  |  | 2x10P |
|              |  | 2x4P |  |  | 2x9P  |
| C4201WVA-F-2 |  | 2x5P |  |  | 2x8P  |
|              |  | 2x6P |  |  | 2x7P  |

C4201WR-2 C4201WR-E-2 C4201WR-F-2

|             |  |      |  |  |       |
|-------------|--|------|--|--|-------|
| C4201WR-2   |  | 2x1P |  |  | 2x12P |
|             |  | 2x2P |  |  | 2x11P |
| C4201WR-E-2 |  | 2x3P |  |  | 2x10P |
|             |  | 2x4P |  |  | 2x9P  |
| C4201WR-F-2 |  | 2x5P |  |  | 2x8P  |
|             |  | 2x6P |  |  | 2x7P  |

## C4201HFA-2

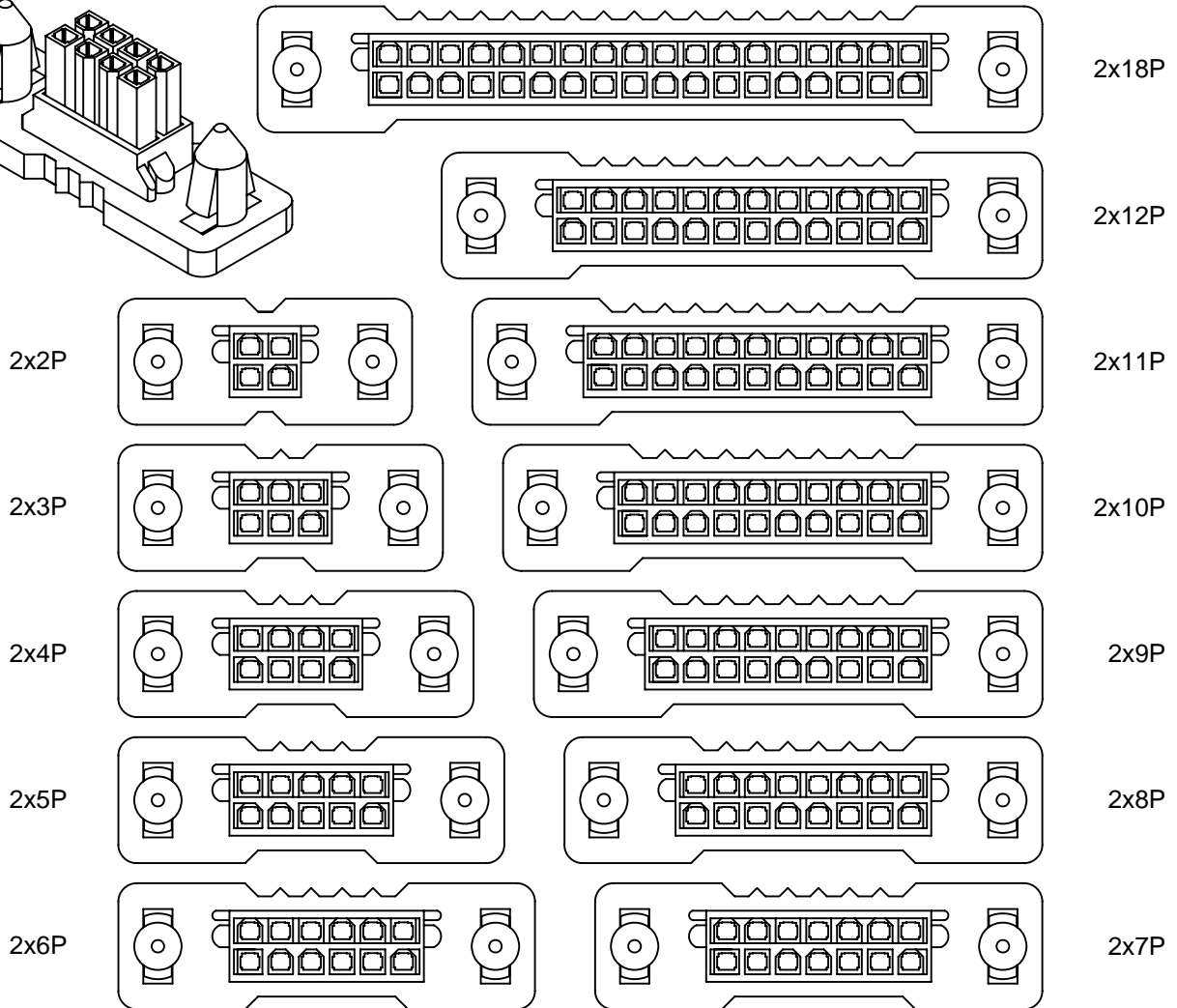
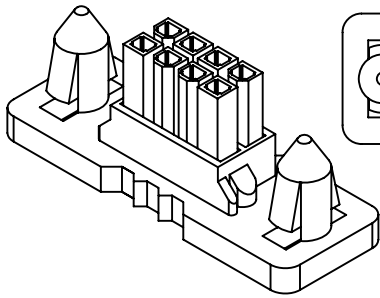

## C4201HV-2

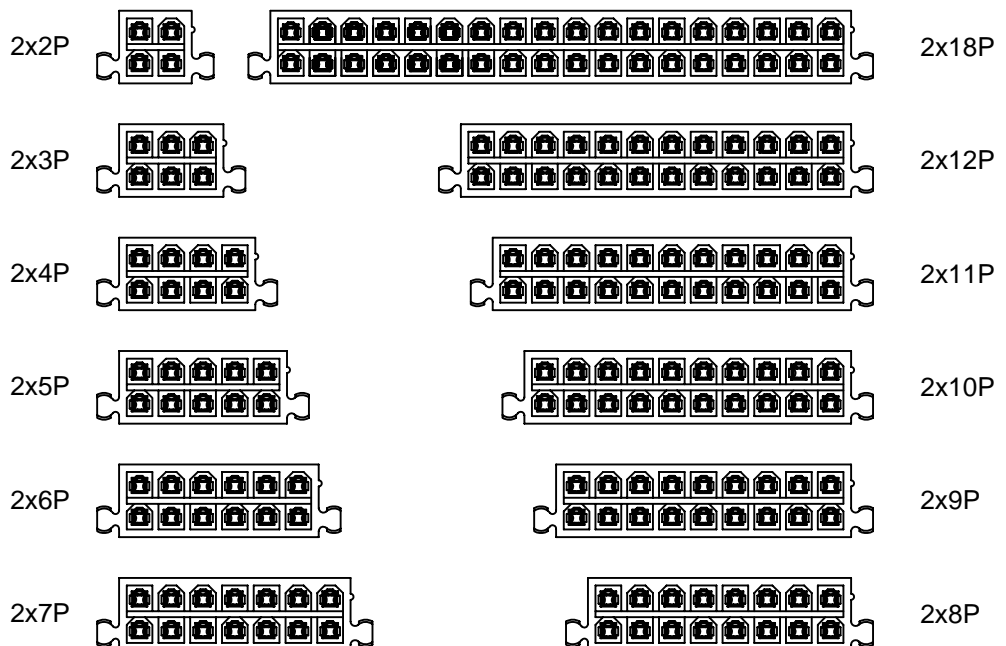
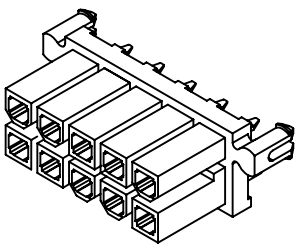

### C4201HMB-2

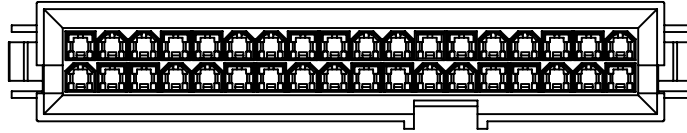
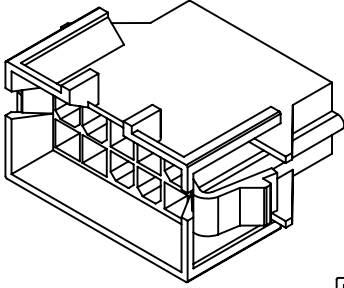

2x18P

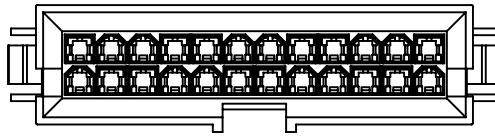

2x12P

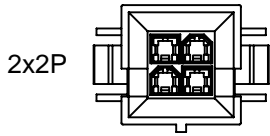

2x2P

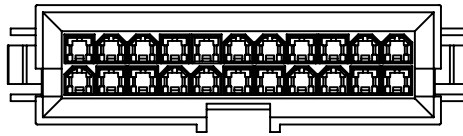

2x11P

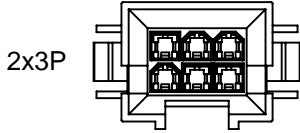

2x3P

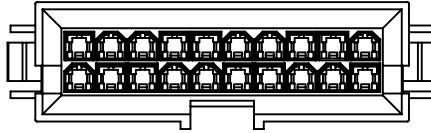

2x10P

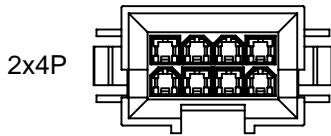

2x4P

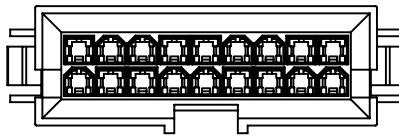

2x9P

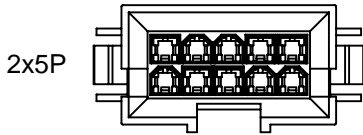

2x5P

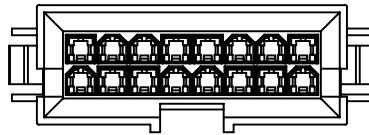

2x8P

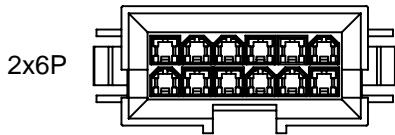

2x6P

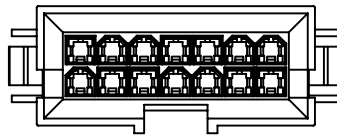

2x7P

C4201WVA-F1-2

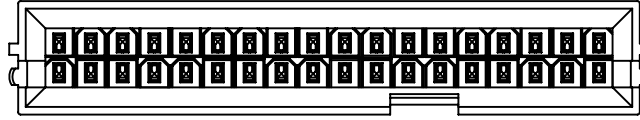
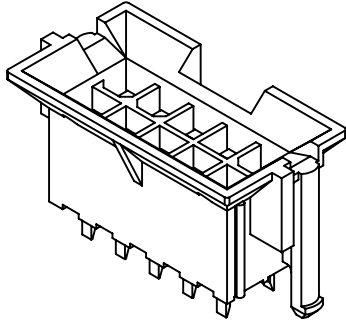

2x18P

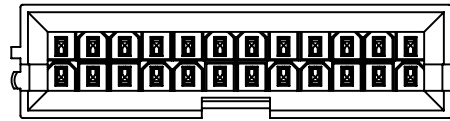

2x12P

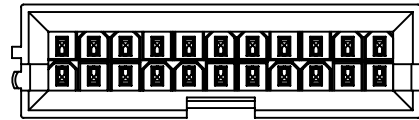
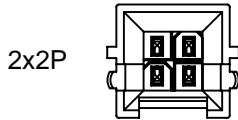

2x11P

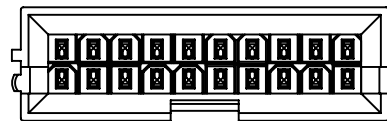
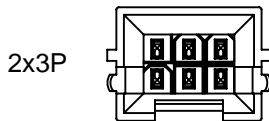

2x10P

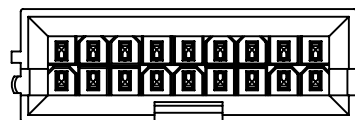
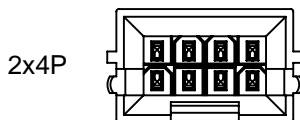

2x9P

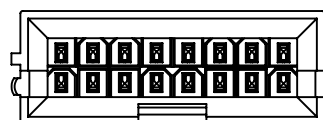
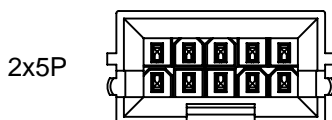

2x8P

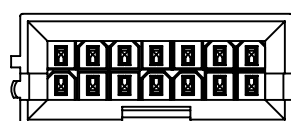
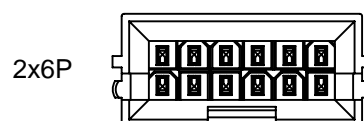

2x7P



### C4201WR-F1-2

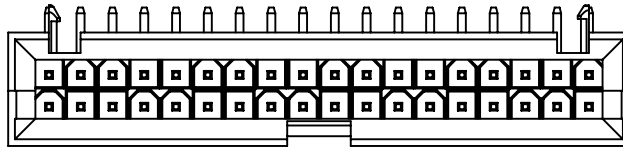
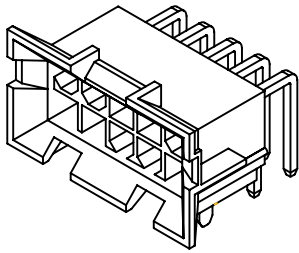

2x18P

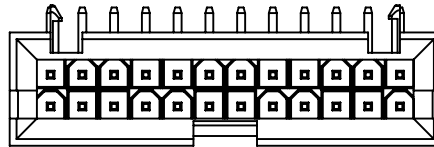

2x12P

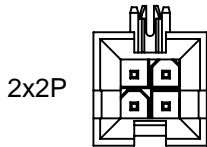

2x2P

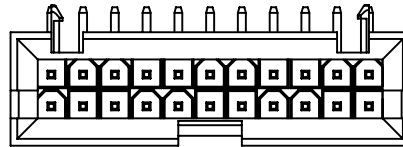

2x11P

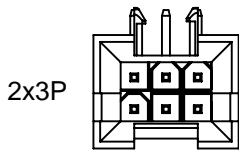

2x3P

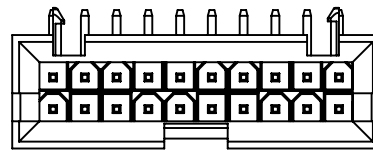

2x10P

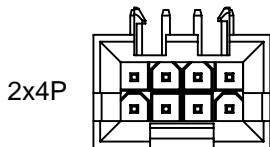

2x4P

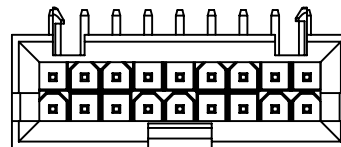

2x9P

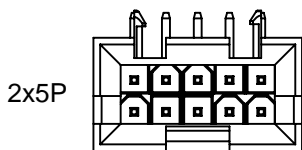

2x5P

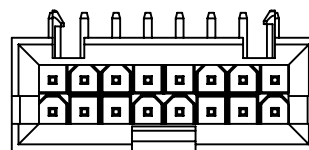

2x8P

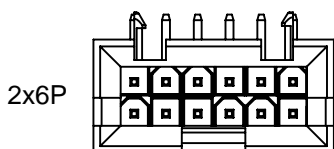

2x6P

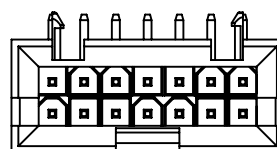

2x7P

## C4201F-T

4.20mm pitch Crimp Terminal

### Reference Informations:

\*Used in CJT C4201HF series Housing

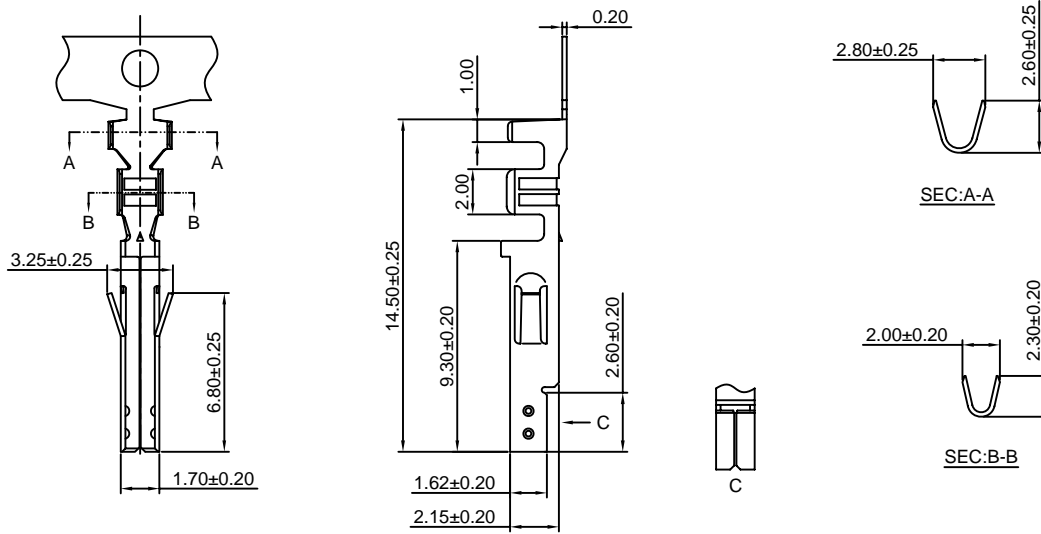

### Ordering information & Specifications:

Unit:mm

| Part NO.  | Wire Range | Insulation O.D. | Material        | Finish           | Qty/reel   |
|-----------|------------|-----------------|-----------------|------------------|------------|
| C4201F-TB | AWG#22-#28 | 1.80mm(max)     | Brass           | Tin over Nickel  | 10,000 PCS |
| C4201F-TP | AWG#22-#28 | 1.80mm(max)     | Phosphor Bronze | Tin over Nickel  | 10,000 PCS |
| C4201F-GB | AWG#22-#28 | 1.80mm(max)     | Brass           | Gold over Nickel | 10,000 PCS |
| C4201F-GP | AWG#22-#28 | 1.80mm(max)     | Phosphor Bronze | Gold over Nickel | 10,000 PCS |

Optional Gold plating available but MOQ requested

## C4201M-T

4.20mm pitch Crimp Terminal

### Reference Informations:

\*Used in CJT C4201HM or C4201HMA series Housing

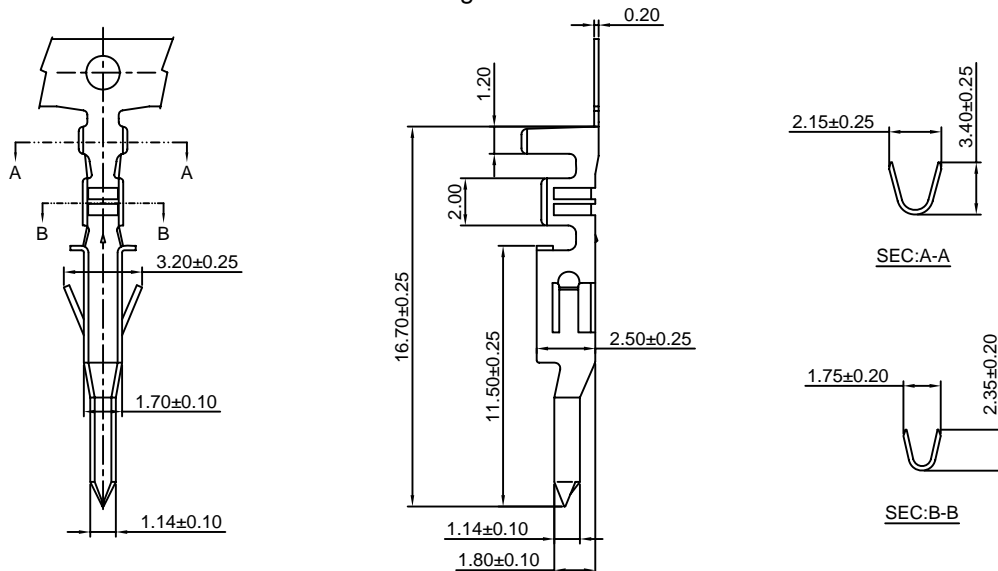

### Ordering information & Specifications:

Unit:mm

| Part NO.  | Wire Range | Insulation O.D. | Material        | Finish           | Qty/reel  |
|-----------|------------|-----------------|-----------------|------------------|-----------|
| C4201M-TB | AWG#22-#28 | 1.80mm(max)     | Brass           | Tin over Nickel  | 5,000 PCS |
| C4201M-TP | AWG#22-#28 | 1.80mm(max)     | Phosphor Bronze | Tin over Nickel  | 5,000 PCS |
| C4201M-GB | AWG#22-#28 | 1.80mm(max)     | Brass           | Gold over Nickel | 5,000 PCS |
| C4201M-GP | AWG#22-#28 | 1.80mm(max)     | Phosphor Bronze | Gold over Nickel | 5,000 PCS |

Optional Gold plating available but MOQ requested

## C4201F-T-H

4.20mm pitch Crimp Terminal

### Reference Informations:

\*Used in CJT C4201HF series Housing

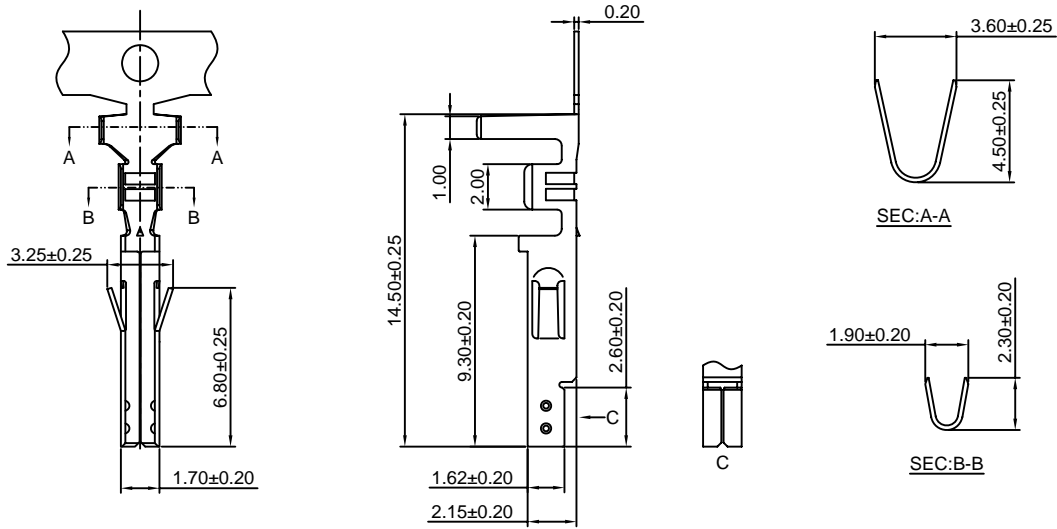

### Ordering information & Specifications:

Unit:mm

| Part NO.    | Wire Range | Insulation O.D. | Material        | Finish           | Qty/reel  |
|-------------|------------|-----------------|-----------------|------------------|-----------|
| C4201F-TB-H | AWG#18-#24 | 3.10mm(max)     | Brass           | Tin over Nickel  | 4,500 PCS |
| C4201F-TP-H | AWG#18-#24 | 3.10mm(max)     | Phosphor Bronze | Tin over Nickel  | 4,500 PCS |
| C4201F-GB-H | AWG#18-#24 | 3.10mm(max)     | Brass           | Gold over Nickel | 4,500 PCS |
| C4201F-GP-H | AWG#18-#24 | 3.10mm(max)     | Phosphor Bronze | Gold over Nickel | 4,500 PCS |

Optional Gold plating available but MOQ requested

## C4201M-T-H

4.20mm pitch Crimp Terminal

### Reference Informations:

\*Used in CJT C4201HM or C4201HMA series Housing

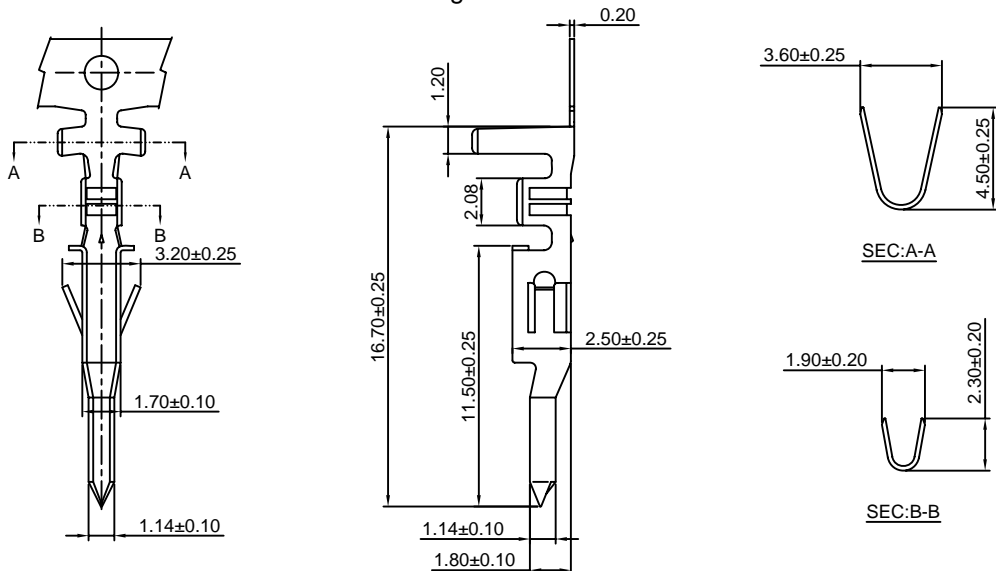

### Ordering information & Specifications:

Unit:mm

| Part NO.    | Wire Range | Insulation O.D. | Material        | Finish           | Qty/reel  |
|-------------|------------|-----------------|-----------------|------------------|-----------|
| C4201M-TB-H | AWG#18-#24 | 3.10mm(max)     | Brass           | Tin over Nickel  | 5,000 PCS |
| C4201M-TP-H | AWG#18-#24 | 3.10mm(max)     | Phosphor Bronze | Tin over Nickel  | 5,000 PCS |
| C4201M-GB-H | AWG#18-#24 | 3.10mm(max)     | Brass           | Gold over Nickel | 5,000 PCS |
| C4201M-GP-H | AWG#18-#24 | 3.10mm(max)     | Phosphor Bronze | Gold over Nickel | 5,000 PCS |

Optional Gold plating available but MOQ requested

## C4201F-T-HH

4.20mm pitch Crimp Terminal

### Reference Informations:

\*Used in CJT C4201HF series Housing

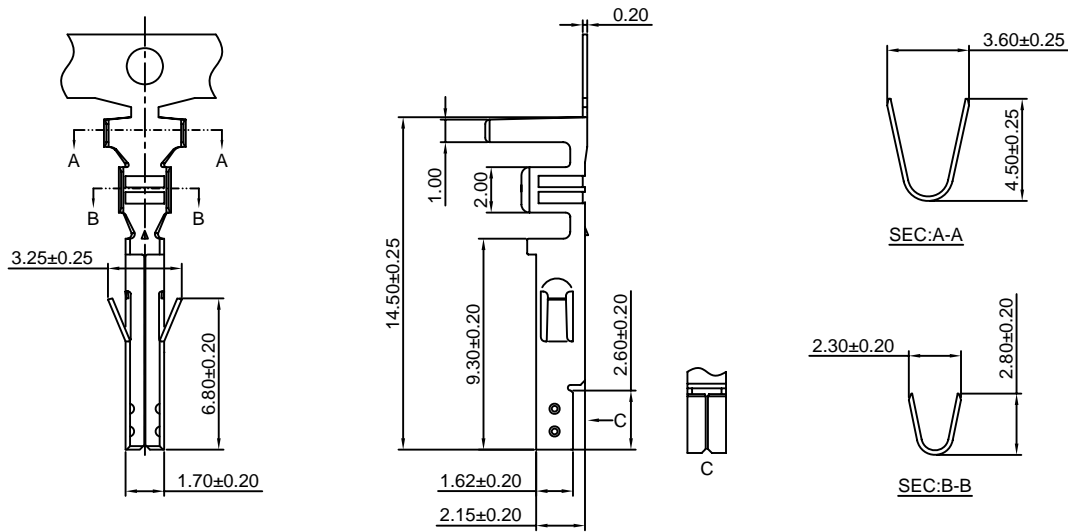

### Ordering information & Specifications:

Unit:mm

| Part NO.     | Wire Range | Insulation O.D. | Material        | Finish           | Qty/reel  |
|--------------|------------|-----------------|-----------------|------------------|-----------|
| C4201F-TB-HH | AWG#16     | 4.30mm(max)     | Brass           | Tin over Nickel  | 4,500 PCS |
| C4201F-TP-HH | AWG#16     | 4.30mm(max)     | Phosphor Bronze | Tin over Nickel  | 4,500 PCS |
| C4201F-GB-HH | AWG#16     | 4.30mm(max)     | Brass           | Gold over Nickel | 4,500 PCS |
| C4201F-GP-HH | AWG#16     | 4.30mm(max)     | Phosphor Bronze | Gold over Nickel | 4,500 PCS |

Optional Gold plating available but MOQ requested

## C4201M-T-HH

4.20mm pitch Crimp Terminal

### Reference Informations:

\*Used in CJT C4201HM or C4201HMA series Housing

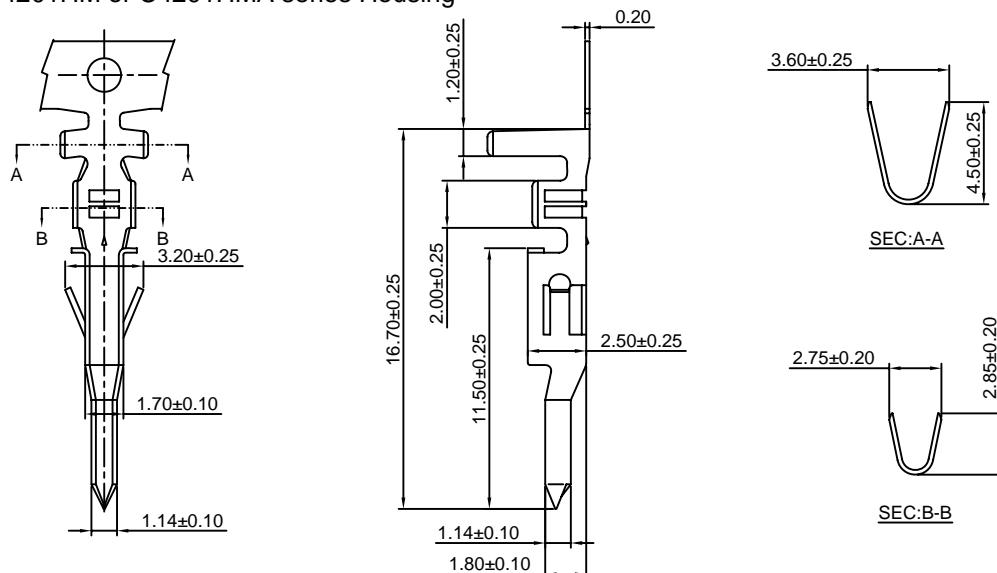

### Ordering information & Specifications:

Unit:mm

| Part NO.     | Wire Range | Insulation O.D. | Material        | Finish           | Qty/reel  |
|--------------|------------|-----------------|-----------------|------------------|-----------|
| C4201M-TB-HH | AWG#16     | 4.30mm(max)     | Brass           | Tin over Nickel  | 4,000 PCS |
| C4201M-TP-HH | AWG#16     | 4.30mm(max)     | Phosphor Bronze | Tin over Nickel  | 4,000 PCS |
| C4201M-GB-HH | AWG#16     | 4.30mm(max)     | Brass           | Gold over Nickel | 4,000 PCS |
| C4201M-GP-HH | AWG#16     | 4.30mm(max)     | Phosphor Bronze | Gold over Nickel | 4,000 PCS |

Optional Gold plating available but MOQ requested

## C4201HF

4.20mm Pitch Single Row Housing

### Reference Informations:

- \*Material: Nylon 66, UL94V-2 or UL94V-0
- \*Suitable CJT C4201F series Terminal
- \*Mates with CJT C4201HM, C4201HMA series single row Housing or C4201 series single row Wafer
- \*Color: Natural

### Ordering Information:

- C4201HF-XP - \*\*
- |   |   |
|---|---|
| 1 | 2 |
|---|---|
1. Part No.  
2. Material:  
(blank): UL94V-2 / Natural  
V0: UL94V-0 / White

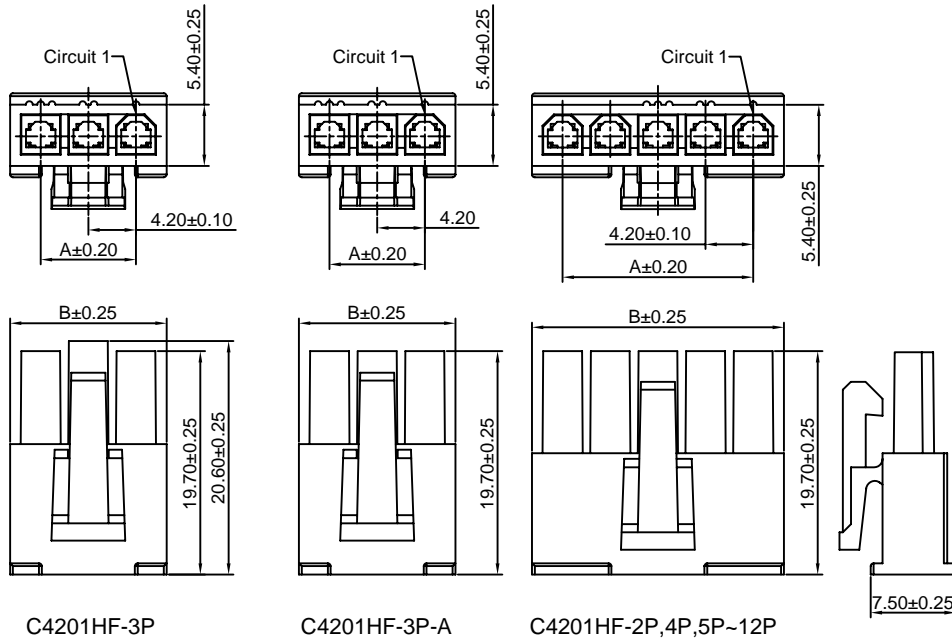
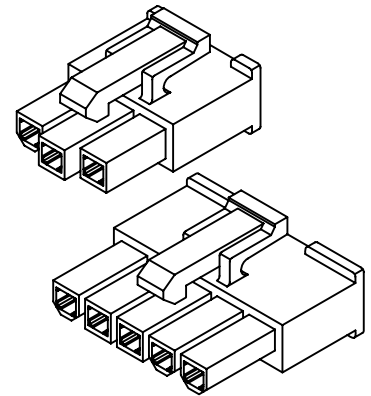

### Ordering Information & Dimensions:

| PART NO.    | Dimensions |       |
|-------------|------------|-------|
|             | A          | B     |
| C4201HF-2P  | 4.20       | 9.60  |
| C4201HF-3P  | 8.40       | 13.80 |
| C4201HF-4P  | 12.60      | 18.00 |
| C4201HF-5P  | 16.80      | 22.20 |
| C4201HF-6P  | 21.00      | 26.40 |
| C4201HF-7P  | 25.20      | 30.60 |
| C4201HF-8P  | 29.40      | 34.80 |
| C4201HF-9P  | 33.60      | 39.00 |
| C4201HF-10P | 37.80      | 43.20 |
| C4201HF-11P | 42.00      | 47.40 |
| C4201HF-12P | 46.20      | 51.60 |

Unit: mm

## C4201HM

4.20mm Pitch Single Row Housing

### Reference Informations:

- \*Material: Nylon 66, UL94V-2 or UL94V-0
- \*Suitable CJT C4201M series Terminal
- \*Mates with CJT C4201HF series single row Housing
- \*Color: Natural

### Ordering Information:

- C4201HM-XP - \*\*
- |   |   |
|---|---|
| 1 | 2 |
|---|---|
1. Part No.  
2. Material:  
(blank): UL94V-2 / Natural  
V0: UL94V-0 / White

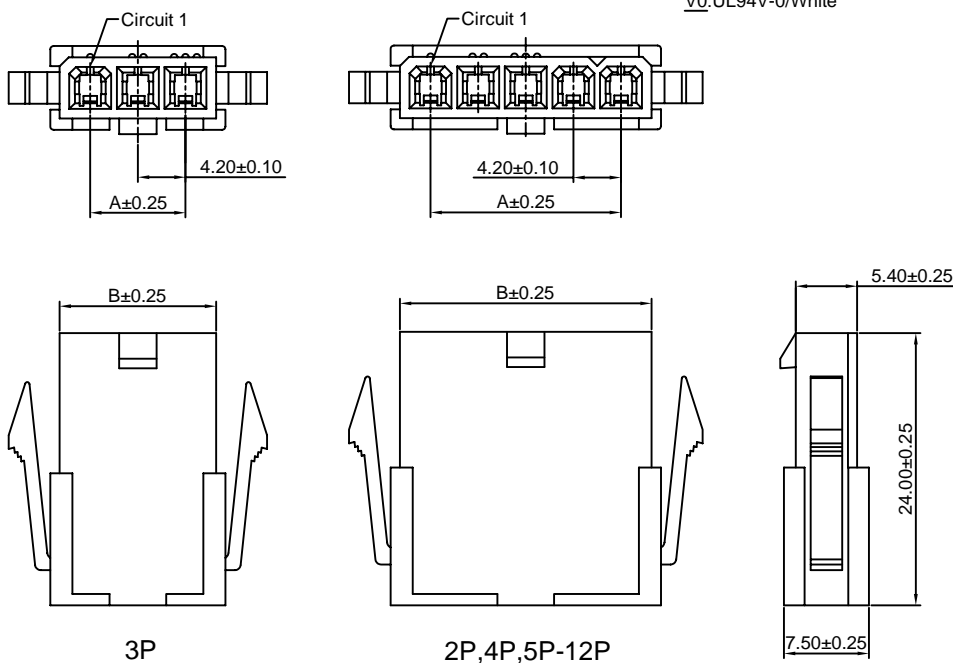
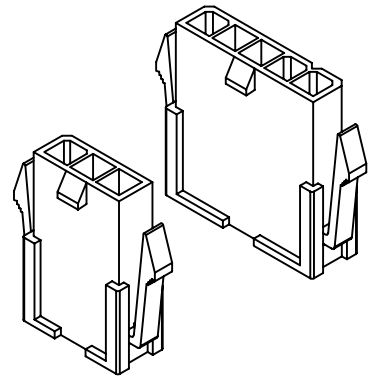

### Ordering Information & Dimensions:

| PART NO.    | Dimensions |       |
|-------------|------------|-------|
|             | A          | B     |
| C4201HM-2P  | 4.20       | 9.60  |
| C4201HM-3P  | 8.40       | 13.80 |
| C4201HM-4P  | 12.60      | 18.00 |
| C4201HM-5P  | 16.80      | 22.20 |
| C4201HM-6P  | 21.00      | 26.40 |
| C4201HM-7P  | 25.20      | 30.60 |
| C4201HM-8P  | 29.40      | 34.80 |
| C4201HM-9P  | 33.60      | 39.00 |
| C4201HM-10P | 37.80      | 43.20 |
| C4201HM-11P | 42.00      | 47.40 |
| C4201HM-12P | 46.20      | 51.60 |

Unit: mm

## C4201HMA

4.20mm Pitch Single Row Housing - Without Mounting Ears

### Reference Informations:

- \*Material: Nylon 66, UL94V-2 or UL94V-0
- \*Suitable CJT C4201M series Terminal
- \*Mates with CJT C4201HF series single row Housing
- \*Color: Natural

### Ordering Information:

- C4201HMA-XP - \*\*
- |   |   |
|---|---|
| 1 | 2 |
|---|---|
- Part No.
  - Material:  
(blank): UL94V-2 / Natural  
V0: UL94V-0 / White

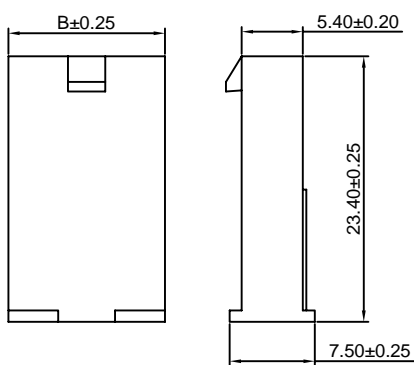
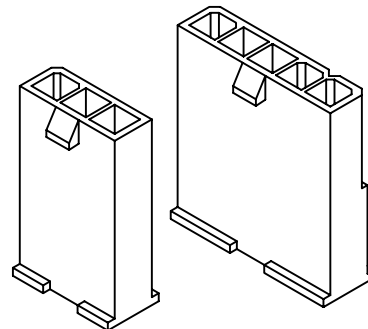
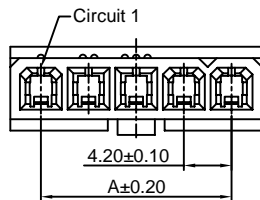
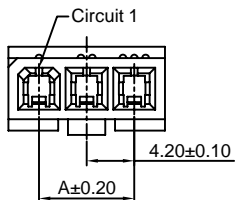

3P

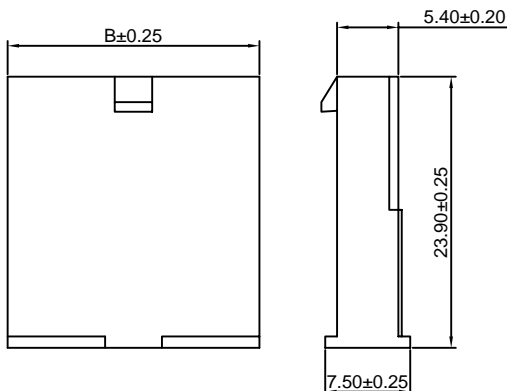

2P, 4P, 5P, 12P

### Ordering Information & Dimensions:

| PART NO.     | Dimensions |       |
|--------------|------------|-------|
|              | A          | B     |
| C4201HMA-2P  | 4.20       | 9.60  |
| C4201HMA-3P  | 8.40       | 13.80 |
| C4201HMA-4P  | 12.60      | 18.00 |
| C4201HMA-5P  | 16.80      | 22.20 |
| C4201HMA-6P  | 21.00      | 26.40 |
| C4201HMA-7P  | 25.20      | 30.60 |
| C4201HMA-8P  | 29.40      | 34.80 |
| C4201HMA-9P  | 33.60      | 39.00 |
| C4201HMA-10P | 37.80      | 43.20 |
| C4201HMA-11P | 42.00      | 47.40 |
| C4201HMA-12P | 46.20      | 51.60 |

Unit: mm

## C4201HF-2

4.20mm pitch Dual Row Housing

### Reference Informations:

- \*Material: Nylon 66, UL94V-2 or UL94V-0
- \*Suitable CJT C4201F series Terminal
- \*Mates with CJT C4201HM, C4201HMA series dual row Housing or C4201 series dual row Wafer
- \*Color: Natural

### Ordering Information:

- C4201HF-2xXP - \*\*
- |   |   |
|---|---|
| 1 | 2 |
|---|---|
- Part No.
  - Material:  
(blank): UL94V-2 / Natural  
V0: UL94V-0 / White

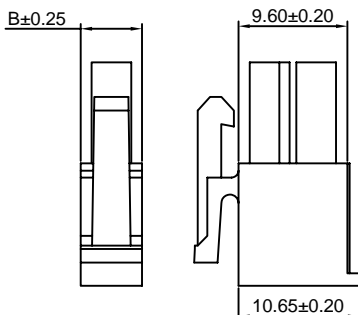
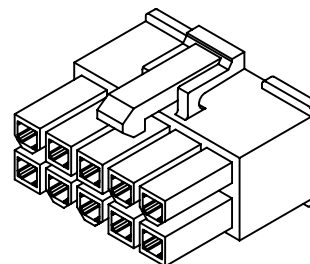
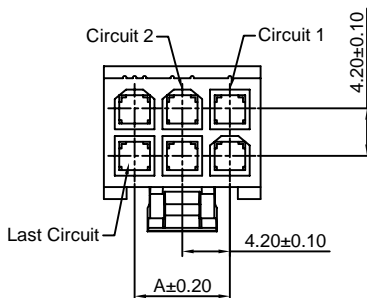
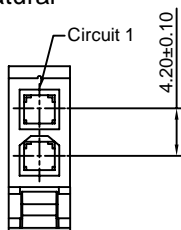

2x1P

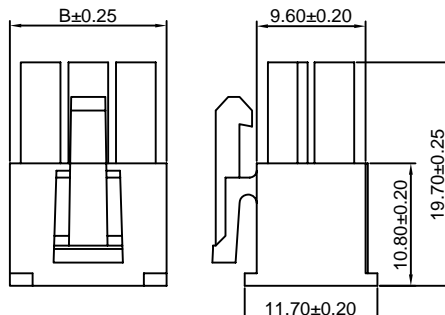

2x2P~2x12P

### Ordering Information & Dimensions:

| PART NO.      | Dimensions |       |
|---------------|------------|-------|
|               | A          | B     |
| C4201HF-2x1P  | -----      | 5.40  |
| C4201HF-2x2P  | 4.20       | 9.60  |
| C4201HF-2x3P  | 8.40       | 13.80 |
| C4201HF-2x4P  | 12.60      | 18.00 |
| C4201HF-2x5P  | 16.80      | 22.20 |
| C4201HF-2x6P  | 21.00      | 26.40 |
| C4201HF-2x7P  | 25.20      | 30.60 |
| C4201HF-2x8P  | 29.40      | 34.80 |
| C4201HF-2x9P  | 33.60      | 39.00 |
| C4201HF-2x10P | 37.80      | 43.20 |
| C4201HF-2x11P | 42.00      | 47.40 |
| C4201HF-2x12P | 46.20      | 51.60 |

Unit: mm

## C4201HM-2

4.20mm pitch Dual Row Housing

### Reference Informations:

- \*Material:Nylon 66,UL94V-2 or UL94V-0
- \*Suitable CJT C4201M series Terminal
- \*Mates with CJT C4201HF series dual row Housing
- \*Color:Natural

### Ordering Information:

- C4201HM-2xXP - \*\*  
 $\frac{1}{2}$
- 1.Part No.
  - 2.Material:  
 (blank):UL94V-2 /Natural  
 V0:UL94V-0/White

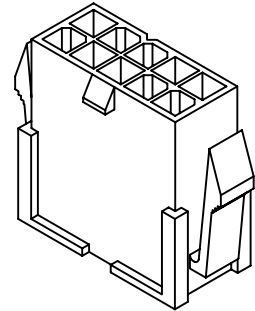
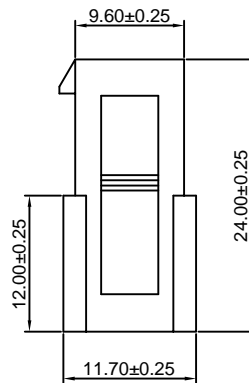
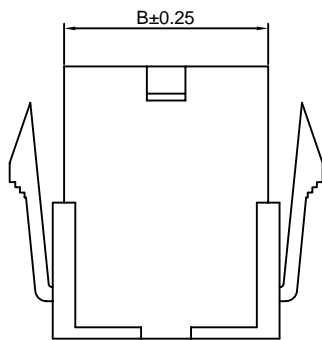
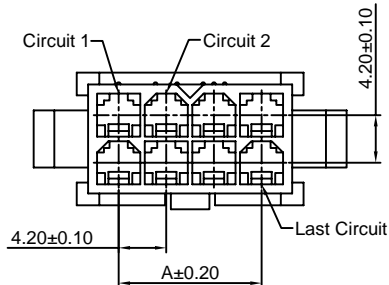

### Ordering Information & Dimensions:

| PART NO.      | Dimensions |       |
|---------------|------------|-------|
|               | A          | B     |
| C4201HM-2x1P  | -----      | 5.40  |
| C4201HM-2x2P  | 4.20       | 9.60  |
| C4201HM-2x3P  | 8.40       | 13.80 |
| C4201HM-2x4P  | 12.60      | 18.00 |
| C4201HM-2x5P  | 16.80      | 22.20 |
| C4201HM-2x6P  | 21.00      | 26.40 |
| C4201HM-2x7P  | 25.20      | 30.60 |
| C4201HM-2x8P  | 29.40      | 34.80 |
| C4201HM-2x9P  | 33.60      | 39.00 |
| C4201HM-2x10P | 37.80      | 43.20 |
| C4201HM-2x11P | 42.00      | 47.40 |
| C4201HM-2x12P | 46.20      | 51.60 |

Unit: mm

## C4201HM-2-A

4.20mm pitch Dual Row Housing

### Reference Informations:

- \*Material:Nylon 66,UL94V-2 or UL94V-0
- \*Suitable CJT C4201M series Terminal
- \*Mates with CJT C4201HF series dual row Housing
- \*Color:Natural

### Ordering Information:

- C4201HM-2xXP - \*\*  
 $\frac{1}{2}$
- 1.Part No.
  - 2.Material:  
 (blank):UL94V-2 /Natural  
 V0:UL94V-0/White

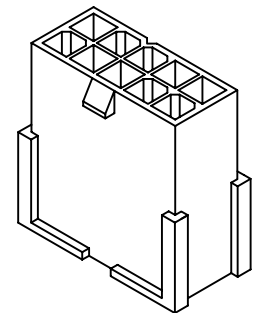
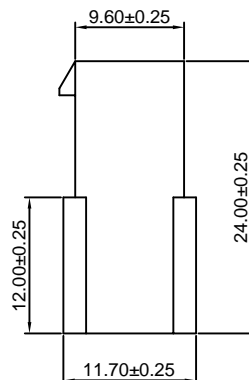
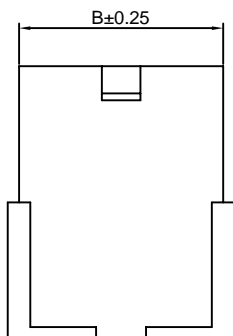
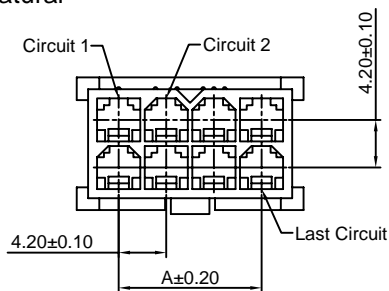

### Ordering Information & Dimensions:

| PART NO.        | Dimensions |       |
|-----------------|------------|-------|
|                 | A          | B     |
| C4201HM-2x1P-A  | -----      | 5.40  |
| C4201HM-2x2P-A  | 4.20       | 9.60  |
| C4201HM-2x3P-A  | 8.40       | 13.80 |
| C4201HM-2x4P-A  | 12.60      | 18.00 |
| C4201HM-2x5P-A  | 16.80      | 22.20 |
| C4201HM-2x6P-A  | 21.00      | 26.40 |
| C4201HM-2x7P-A  | 25.20      | 30.60 |
| C4201HM-2x8P-A  | 29.40      | 34.80 |
| C4201HM-2x9P-A  | 33.60      | 39.00 |
| C4201HM-2x10P-A | 37.80      | 43.20 |
| C4201HM-2x11P-A | 42.00      | 47.40 |
| C4201HM-2x12P-A | 46.20      | 51.60 |

Unit: mm







### C4201WVA

4.20mm pitch 180° Single Row Wafer With Pegs

#### Reference Informations:

- \*Material: Pin: Brass/Tin over Nickel  
Insulator: Nylon 66, UL94V-2 or UL94V-0
- \*Mates with CJT C4201HF series single row Housing
- \*Color: Natural

Ordering Information:  
C4201WVA-F-XP - \*\*  
1 2

- 1. Part No.
- 2. Material:  
(blank): UL94V-2 / Natural  
V0: UL94V-0 / White

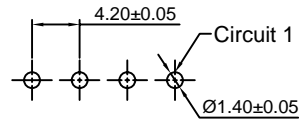
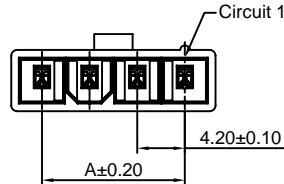
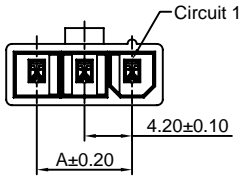
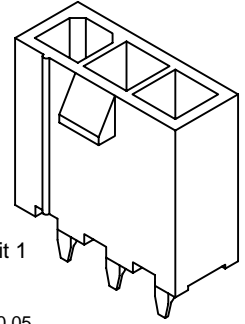

P.C.B LAYOUT

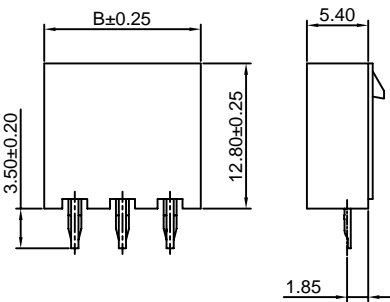

3P

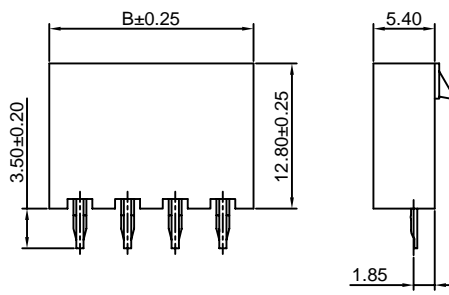

2P, 4P~12P

#### Ordering Information & Dimensions:

| PART NO.     | Dimensions |       |
|--------------|------------|-------|
|              | A          | B     |
| C4201WVA-2P  | 4.20       | 9.60  |
| C4201WVA-3P  | 8.40       | 13.80 |
| C4201WVA-4P  | 12.60      | 18.00 |
| C4201WVA-5P  | 16.80      | 22.20 |
| C4201WVA-6P  | 21.00      | 26.40 |
| C4201WVA-7P  | 25.20      | 30.60 |
| C4201WVA-8P  | 29.40      | 34.80 |
| C4201WVA-9P  | 33.60      | 39.00 |
| C4201WVA-10P | 37.80      | 43.20 |
| C4201WVA-11P | 42.00      | 47.40 |
| C4201WVA-12P | 46.20      | 51.60 |

Unit: mm

### C4201WVA-F

4.20mm pitch 180° Single Row Wafer With Pegs

#### Reference Informations:

- \*Material: Pin: Brass/Tin over Nickel  
Insulator: Nylon 66, UL94V-2 or UL94V-0
- \*Mates with CJT C4201HF series single row Housing
- \*Color: Natural

Ordering Information:  
C4201WVA-F-XP - \*\*  
1 2

- 1. Part No.
- 2. Material:  
(blank): UL94V-2 / Natural  
V0: UL94V-0 / White

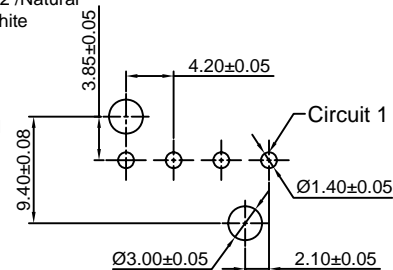
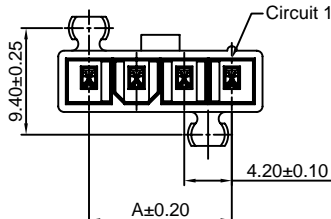
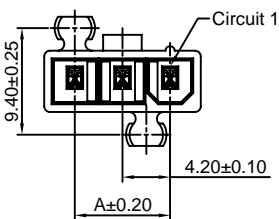
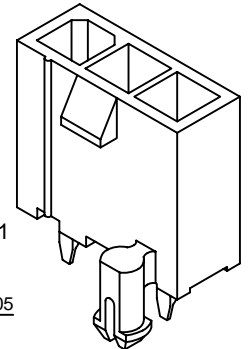

P.C.B LAYOUT

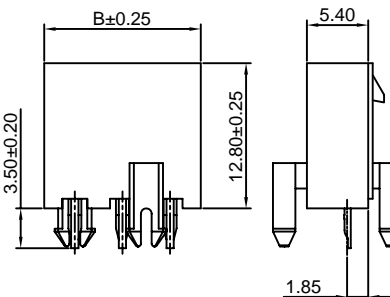

3P

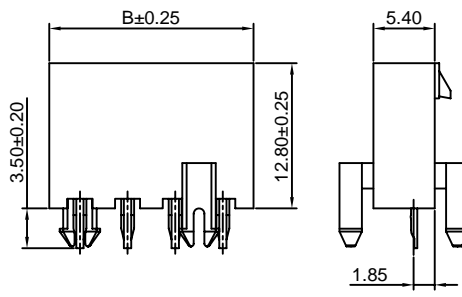

2P, 4P~12P

#### Ordering Information & Dimensions:

| PART NO.       | Dimensions |       |
|----------------|------------|-------|
|                | A          | B     |
| C4201WVA-F-2P  | 4.20       | 9.60  |
| C4201WVA-F-3P  | 8.40       | 13.80 |
| C4201WVA-F-4P  | 12.60      | 18.00 |
| C4201WVA-F-5P  | 16.80      | 22.20 |
| C4201WVA-F-6P  | 21.00      | 26.40 |
| C4201WVA-F-7P  | 25.20      | 30.60 |
| C4201WVA-F-8P  | 29.40      | 34.80 |
| C4201WVA-F-9P  | 33.60      | 39.00 |
| C4201WVA-F-10P | 37.80      | 43.20 |
| C4201WVA-F-11P | 42.00      | 47.40 |
| C4201WVA-F-12P | 46.20      | 51.60 |

Unit: mm

### C4201WR

4.20mm pitch 90° Single Row Wafer

#### Reference Informations:

- \*Material: Pin: Brass/Tin over Nickel  
Insulator: Nylon 66, UL94V-2 or UL94V-0
- \*Mates with CJT C4201HF series single row Housing
- \*Color: Natural

#### Ordering Information:

- C4201WR-XP - \*\*  
 $\frac{1}{2}$
1. Part No.
  2. Material:  
 (blank): UL94V-2 / Natural  
 V0: UL94V-0 / White

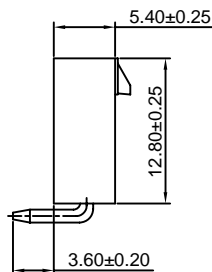
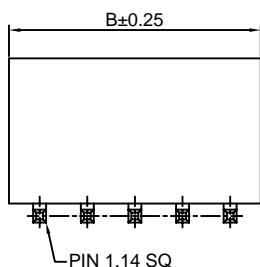
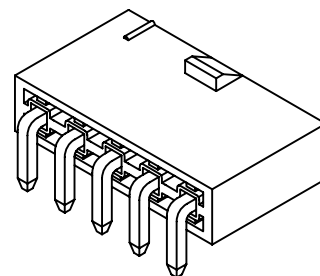
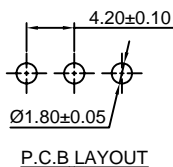
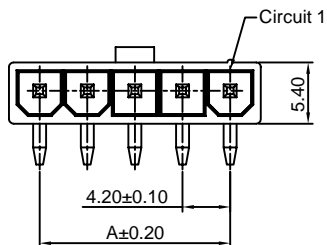

#### Ordering Information & Dimensions:

| PART NO.    | Dimensions |       |
|-------------|------------|-------|
|             | A          | B     |
| C4201WR-2P  | 4.20       | 9.60  |
| C4201WR-3P  | 8.40       | 13.80 |
| C4201WR-4P  | 12.60      | 18.00 |
| C4201WR-5P  | 16.80      | 22.20 |
| C4201WR-6P  | 21.00      | 26.40 |
| C4201WR-7P  | 25.20      | 30.60 |
| C4201WR-8P  | 29.40      | 34.80 |
| C4201WR-9P  | 33.60      | 39.00 |
| C4201WR-10P | 37.80      | 43.20 |
| C4201WR-11P | 42.00      | 47.40 |
| C4201WR-12P | 46.20      | 51.60 |

Unit: mm

### C4201WR-E

4.20mm pitch 90° Single Row Wafer With Ear

#### Reference Informations:

- \*Material: Pin: Brass/Tin over Nickel  
Insulator: Nylon 66, UL94V-2 or UL94V-0
- \*Mates with CJT C4201HF series single row Housing
- \*Color: Natural

#### Ordering Information:

- C4201WR-E-XP - \*\*  
 $\frac{1}{2}$
1. Part No.
  2. Material:  
 (blank): UL94V-2 / Natural  
 V0: UL94V-0 / White

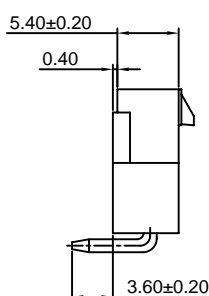
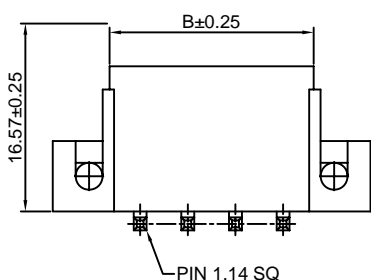
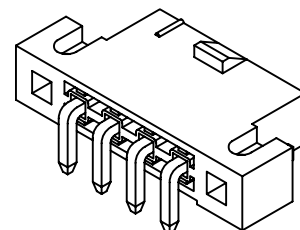
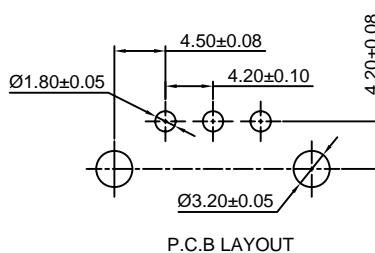
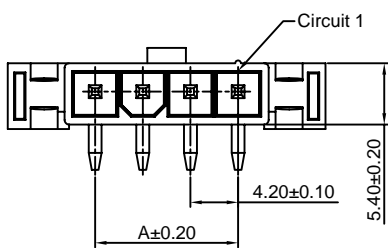

#### Ordering Information & Dimensions:

| PART NO.      | Dimensions |       |
|---------------|------------|-------|
|               | A          | B     |
| C4201WR-E-2P  | 4.20       | 9.60  |
| C4201WR-E-3P  | 8.40       | 13.80 |
| C4201WR-E-4P  | 12.60      | 18.00 |
| C4201WR-E-5P  | 16.80      | 22.20 |
| C4201WR-E-6P  | 21.00      | 26.40 |
| C4201WR-E-7P  | 25.20      | 30.60 |
| C4201WR-E-8P  | 29.40      | 34.80 |
| C4201WR-E-9P  | 33.60      | 39.00 |
| C4201WR-E-10P | 37.80      | 43.20 |
| C4201WR-E-11P | 42.00      | 47.40 |
| C4201WR-E-12P | 46.20      | 51.60 |

Unit: mm

### C4201WR-F

4.20mm pitch 90° Single Row Wafer With Pegs

#### Reference Informations:

- \*Material: Pin: Brass/Tin over Nickel  
Insulator: Nylon 66, UL94V-2 or UL94V-0
- \*Mates with CJT C4201HF series single row Housing
- \*Color: Natural

Ordering Information:  
C4201WR-F-XP - \*\*

1. Part No.
2. Material:  
(blank): UL94V-2 / Natural  
V0: UL94V-0 / White

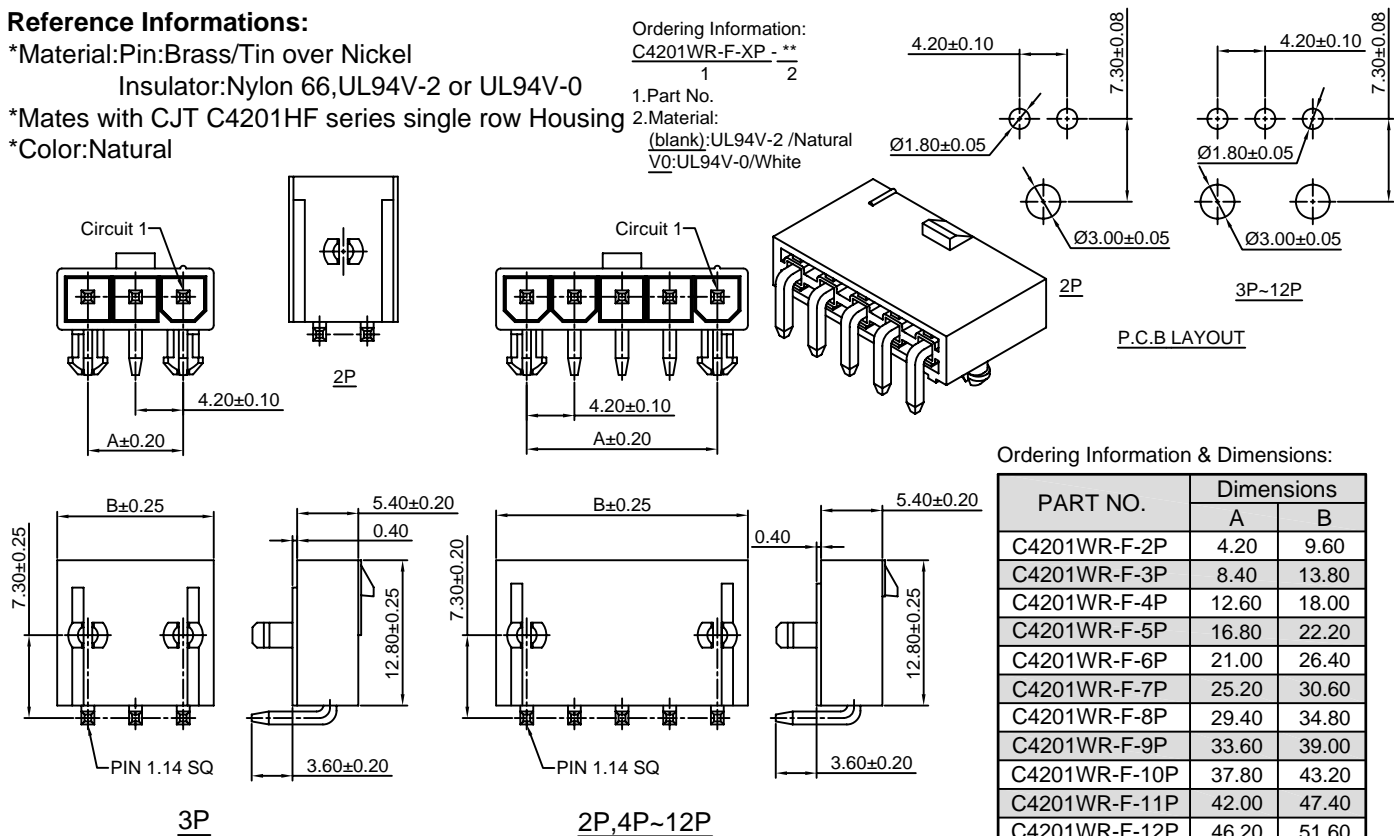

Unit: mm

### C4201WV-2

4.20mm pitch 180° Dual Row Wafer

#### Reference Informations:

- \*Material: Pin: Brass/Tin over Nickel  
Insulator: Nylon 66, UL94V-2 or UL94V-0
- \*Mates with CJT C4201HF series dual row Housing
- \*Color: Natural

Ordering Information:  
C4201WV-2xXP - \*\*

1. Part No.
2. Material:  
(blank): UL94V-2 / Natural  
V0: UL94V-0 / White

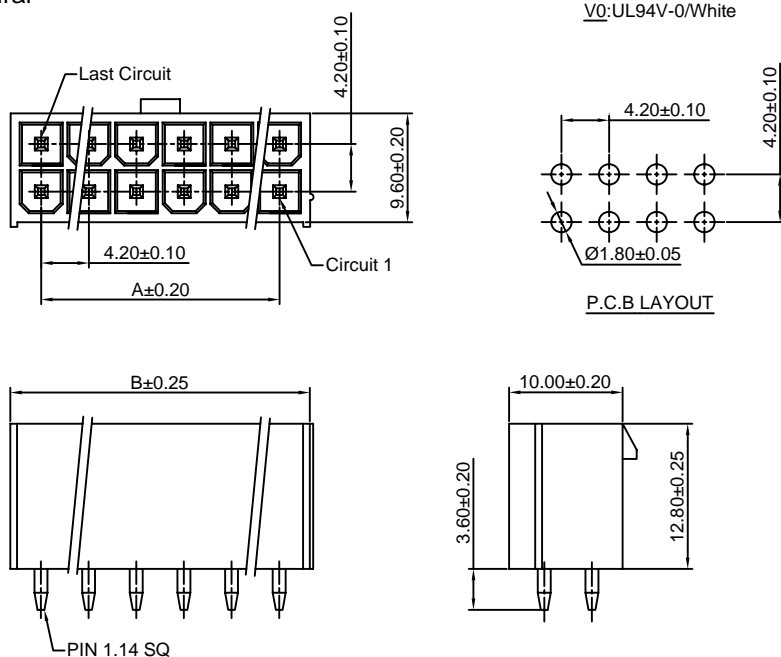

Ordering Information & Dimensions:

| PART NO.      | Dimensions |       |
|---------------|------------|-------|
|               | A          | B     |
| C4201WV-2x1P  | -----      | 5.40  |
| C4201WV-2x2P  | 4.20       | 9.60  |
| C4201WV-2x3P  | 8.40       | 13.80 |
| C4201WV-2x4P  | 12.60      | 18.00 |
| C4201WV-2x5P  | 16.80      | 22.20 |
| C4201WV-2x6P  | 21.00      | 26.40 |
| C4201WV-2x7P  | 25.20      | 30.60 |
| C4201WV-2x8P  | 29.40      | 34.80 |
| C4201WV-2x9P  | 33.60      | 39.00 |
| C4201WV-2x10P | 37.80      | 43.20 |
| C4201WV-2x11P | 42.00      | 47.40 |
| C4201WV-2x12P | 46.20      | 51.60 |

Unit: mm

## C4201WVA-2

4.20mm pitch 180° Dual Row Wafer

### Reference Informations:

- \*Material:Pin:Brass/Tin over Nickel  
Insulator:Nylon 66,UL94V-2 or UL94V-0
- \*Mates with CJT C4201HF series dual row Housing
- \*Color:Natural

### Ordering Information:

- C4201WVA-2xXP - \*\*
- |   |   |
|---|---|
| 1 | 2 |
|---|---|
- Part No.
  - Material:  
(blank):UL94V-2/Natural  
V0:UL94V-0/White

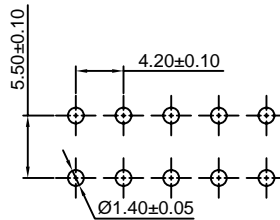
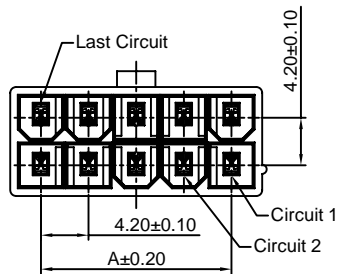

P.C.B LAYOUT

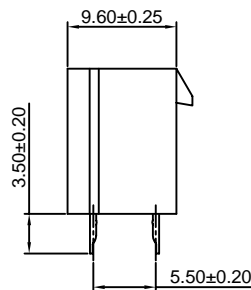
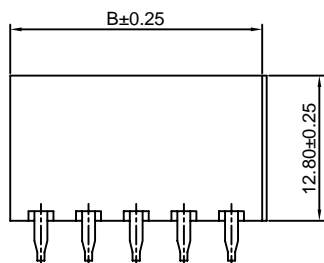
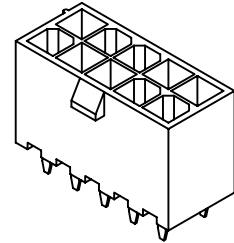

### Ordering Information & Dimensions:

| PART NO.       | Dimensions |       |
|----------------|------------|-------|
|                | A          | B     |
| C4201WVA-2x1P  | -----      | 5.40  |
| C4201WVA-2x2P  | 4.20       | 9.60  |
| C4201WVA-2x3P  | 8.40       | 13.80 |
| C4201WVA-2x4P  | 12.60      | 18.00 |
| C4201WVA-2x5P  | 16.80      | 22.20 |
| C4201WVA-2x6P  | 21.00      | 26.40 |
| C4201WVA-2x7P  | 25.20      | 30.60 |
| C4201WVA-2x8P  | 29.40      | 34.80 |
| C4201WVA-2x9P  | 33.60      | 39.00 |
| C4201WVA-2x10P | 37.80      | 43.20 |
| C4201WVA-2x11P | 42.00      | 47.40 |
| C4201WVA-2x12P | 46.20      | 51.60 |

Unit: mm

## C4201WVA-F-2

4.20mm pitch 180° Dual Row Wafer With Foot

### Reference Informations:

- \*Material:Pin:Brass/Tin over Nickel  
Insulator:Nylon 66,UL94V-2 or UL94V-0
- \*Mates with CJT C4201HF series dual row Housing
- \*Color:Natural

### Ordering Information:

- C4201WVA-F-2xXP - \*\*
- |   |   |
|---|---|
| 1 | 2 |
|---|---|
- Part No.
  - Material:  
(blank):UL94V-2/Natural  
V0:UL94V-0/White

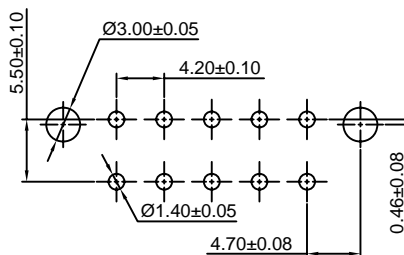
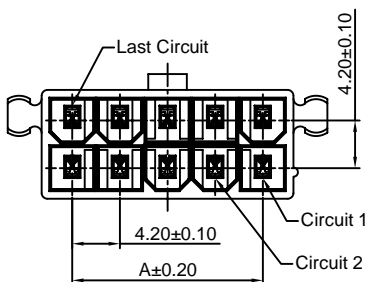

P.C.B LAYOUT

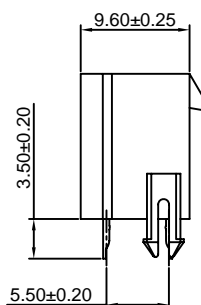
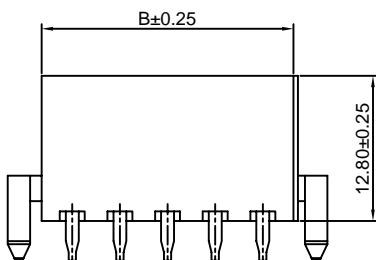
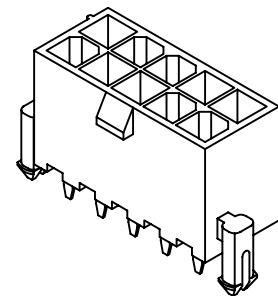

### Ordering Information & Dimensions:

| PART NO.         | Dimensions |       |
|------------------|------------|-------|
|                  | A          | B     |
| C4201WVA-F-2x1P  | -----      | 5.40  |
| C4201WVA-F-2x2P  | 4.20       | 9.60  |
| C4201WVA-F-2x3P  | 8.40       | 13.80 |
| C4201WVA-F-2x4P  | 12.60      | 18.00 |
| C4201WVA-F-2x5P  | 16.80      | 22.20 |
| C4201WVA-F-2x6P  | 21.00      | 26.40 |
| C4201WVA-F-2x7P  | 25.20      | 30.60 |
| C4201WVA-F-2x8P  | 29.40      | 34.80 |
| C4201WVA-F-2x9P  | 33.60      | 39.00 |
| C4201WVA-F-2x10P | 37.80      | 43.20 |
| C4201WVA-F-2x11P | 42.00      | 47.40 |
| C4201WVA-F-2x12P | 46.20      | 51.60 |

Unit: mm

## C4201WR-2

4.20mm pitch 90° Dual Row Wafer

### Reference Informations:

- \*Material: Pin: Brass/Tin over Nickel  
Insulator: Nylon 66, UL94V-2 or UL94V-0
- \*Mates with CJT C4201HF series dual row Housing
- \*Color: Natural

### Ordering Information:

- C4201WR-2xXP - \*\*
- |   |   |
|---|---|
| 1 | 2 |
|---|---|
- Part No.
  - Material:  
(blank): UL94V-2/Natural  
V0: UL94V-0/White

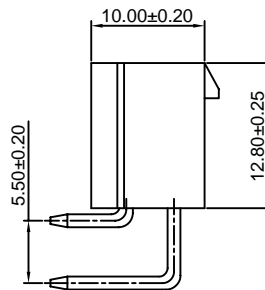
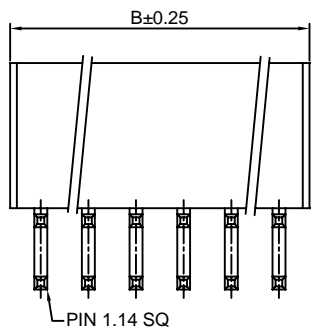
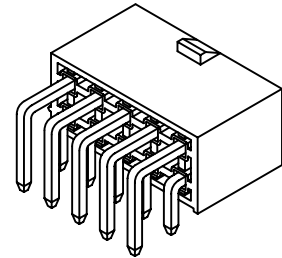
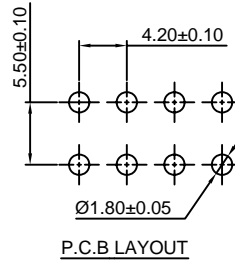
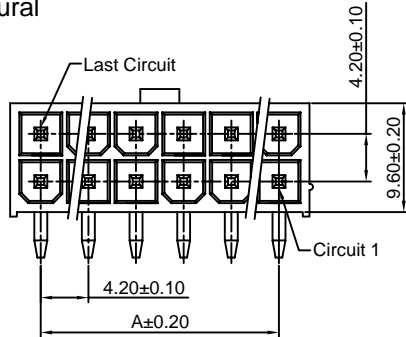

### Ordering Information & Dimensions:

| PART NO.      | Dimensions |       |
|---------------|------------|-------|
|               | A          | B     |
| C4201WR-2x1P  | -----      | 5.40  |
| C4201WR-2x2P  | 4.20       | 9.60  |
| C4201WR-2x3P  | 8.40       | 13.80 |
| C4201WR-2x4P  | 12.60      | 18.00 |
| C4201WR-2x5P  | 16.80      | 22.20 |
| C4201WR-2x6P  | 21.00      | 26.40 |
| C4201WR-2x7P  | 25.20      | 30.60 |
| C4201WR-2x8P  | 29.40      | 34.80 |
| C4201WR-2x9P  | 33.60      | 39.00 |
| C4201WR-2x10P | 37.80      | 43.20 |
| C4201WR-2x11P | 42.00      | 47.40 |
| C4201WR-2x12P | 46.20      | 51.60 |

Unit: mm

## C4201WR-E-2

4.20mm pitch 180° Dual Row Wafer With Ear

### Reference Informations:

- \*Material: Pin: Brass/Tin over Nickel  
Insulator: Nylon 66, UL94V-2 or UL94V-0
- \*Mates with CJT C4201HF series dual row Housing
- \*Color: Natural

### Ordering Information:

- C4201WR-E-2xXP - \*\*
- |   |   |
|---|---|
| 1 | 2 |
|---|---|
- Part No.
  - Material:  
(blank): UL94V-2/Natural  
V0: UL94V-0/White

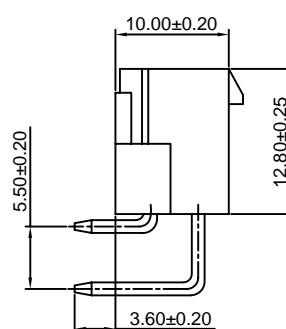
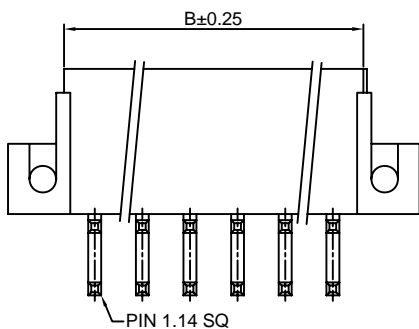
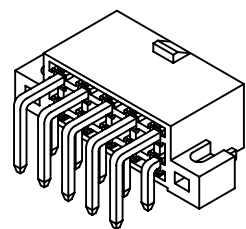
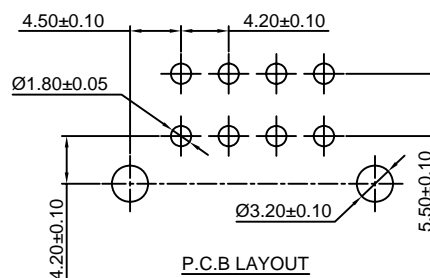
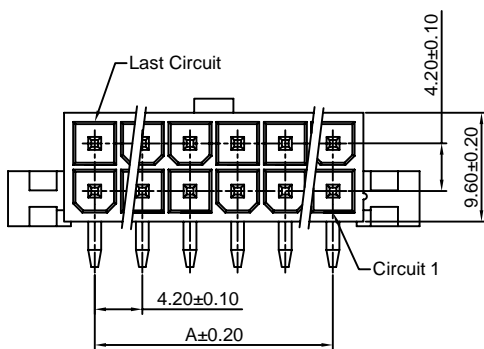

### Ordering Information & Dimensions:

| PART NO.        | Dimensions |       |
|-----------------|------------|-------|
|                 | A          | B     |
| C4201WR-E-2x1P  | -----      | 5.40  |
| C4201WR-E-2x2P  | 4.20       | 9.60  |
| C4201WR-E-2x3P  | 8.40       | 13.80 |
| C4201WR-E-2x4P  | 12.60      | 18.00 |
| C4201WR-E-2x5P  | 16.80      | 22.20 |
| C4201WR-E-2x6P  | 21.00      | 26.40 |
| C4201WR-E-2x7P  | 25.20      | 30.60 |
| C4201WR-E-2x8P  | 29.40      | 34.80 |
| C4201WR-E-2x9P  | 33.60      | 39.00 |
| C4201WR-E-2x10P | 37.80      | 43.20 |
| C4201WR-E-2x11P | 42.00      | 47.40 |
| C4201WR-E-2x12P | 46.20      | 51.60 |

Unit: mm

## C4201WR-F-2

4.20mm pitch 90° Dual Row Wafer With Foot

### Reference Informations:

- \*Material: Pin: Brass/Tin over Nickel  
Insulator: Nylon 66, UL94V-2 or UL94V-0
- \*Mates with CJT C4201HF series dual row Housing
- \*Color: Natural

Ordering Information:  
C4201WR-F-2xXP - \*\*  
1 2

1. Part No.
2. Material:  
(blank): UL94V-2/Natural  
V0: UL94V-0/White

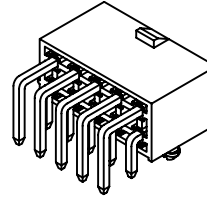
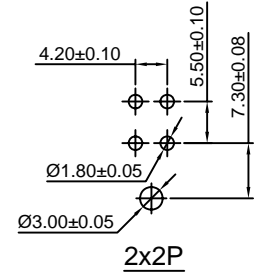
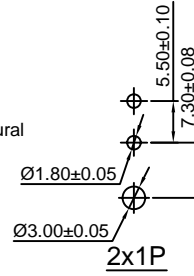
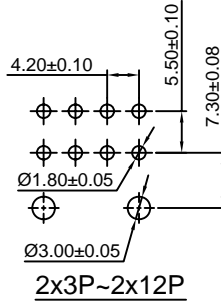
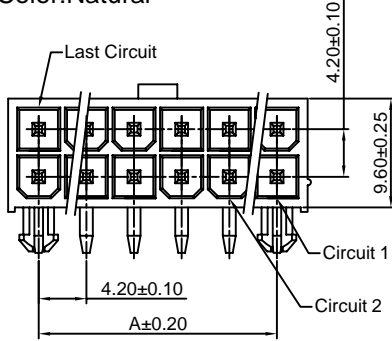

Ordering Information & Dimensions:

| PART NO.        | Dimensions |       |
|-----------------|------------|-------|
|                 | A          | B     |
| C4201WR-F-2x1P  | -----      | 5.40  |
| C4201WR-F-2x2P  | 4.20       | 9.60  |
| C4201WR-F-2x3P  | 8.40       | 13.80 |
| C4201WR-F-2x4P  | 12.60      | 18.00 |
| C4201WR-F-2x5P  | 16.80      | 22.20 |
| C4201WR-F-2x6P  | 21.00      | 26.40 |
| C4201WR-F-2x7P  | 25.20      | 30.60 |
| C4201WR-F-2x8P  | 29.40      | 34.80 |
| C4201WR-F-2x9P  | 33.60      | 39.00 |
| C4201WR-F-2x10P | 37.80      | 43.20 |
| C4201WR-F-2x11P | 42.00      | 47.40 |
| C4201WR-F-2x12P | 46.20      | 51.60 |

Unit: mm

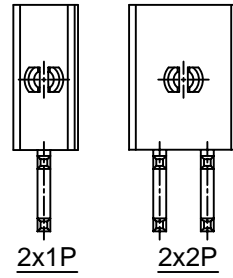
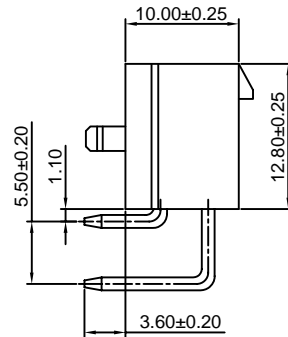
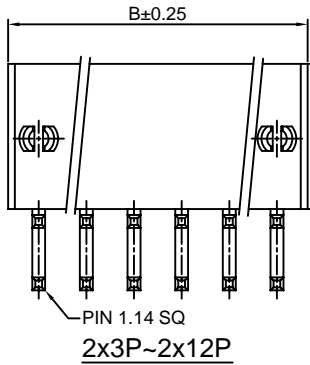

## C4201HF-2x3P-A/B

4.20mm pitch Dual Row Housing - Special Type

### Reference Informations:

- \*Material: Nylon 66, UL94V-2 or UL94V-0
- \*Suitable CJT C4201F series Terminal
- \*Mates with CJT C4201HM or C4201WV special type series dual row Housing or Wafer
- \*Color: Black

Ordering Information:  
C4201HF-2x3P - \*\*  
1 2

1. Part No.
2. Material:  
(blank): UL94V-2/Black  
V0: UL94V-0/Black

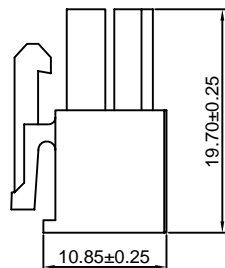
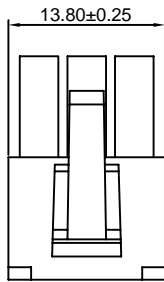
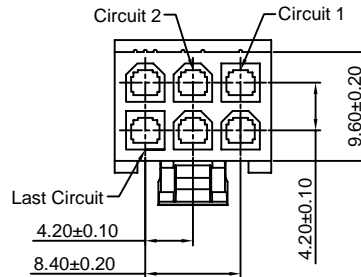
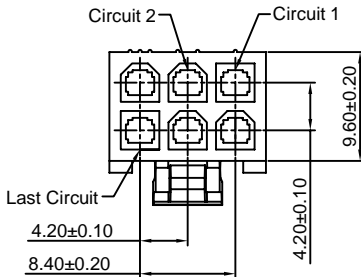
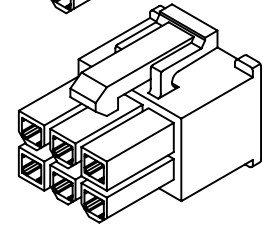
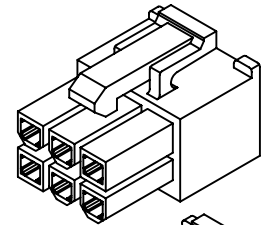

C4201HF-2x3P-A

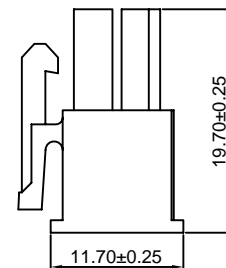
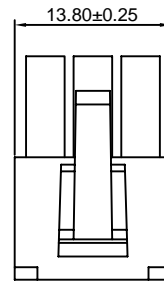

C4201HF-2x3P-B

Unit: mm



### C4201HF-2x4P-A/B

4.20mm pitch Dual Row Housing - Special Type

#### Reference Informations:

- \*Material:Nylon 66,UL94V-2 or UL94V-0
- \*Suitable CJT C4201F series Terminal
- \*Mates with CJT C4201HM or C4201WV special type series dual row Housing or Wafer
- \*Color:Black

#### Ordering Information:

- C4201HF-2x4P - \*\*  
 1 2  
 1.Part No.  
 2.Material:  
 (blank):UL94V-2/Black  
 V0:UL94V-0/Black

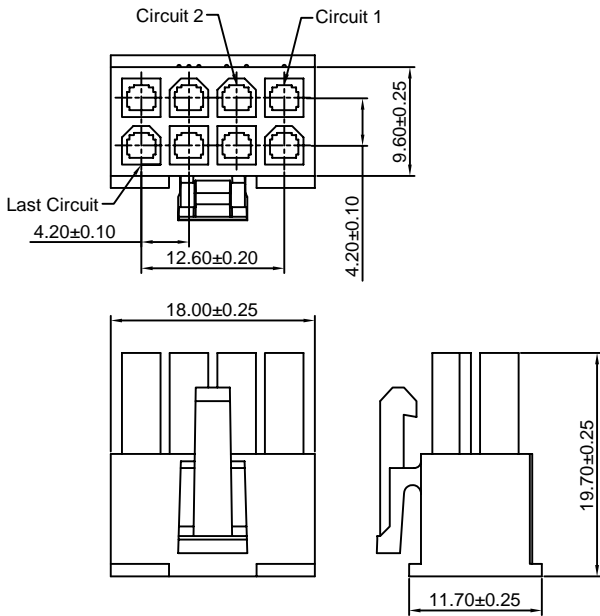
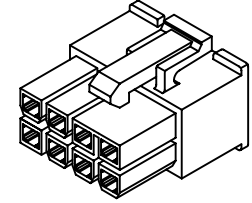
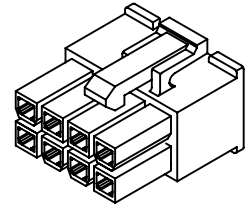

C4201HF-2x4P-A

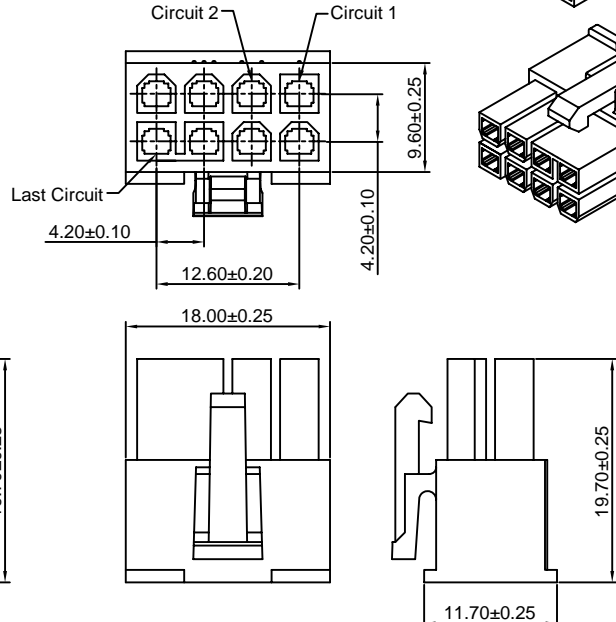

C4201HF-2x4P-B

Unit: mm

### C4201WV-2x3P-B/C

4.20mm pitch Dual Row Housing - Special Type

#### Reference Informations:

- \*Material:Pin:Brass/Tin over Nickel  
Insulator:Nylon 66,UL94V-2 or UL94V-0
- \*Mates with CJT C4201HF special type series dual row Housing
- \*Color:Black

#### Ordering Information:

- C4201WV-2x3P - \*\*  
 1 2  
 1.Part No.  
 2.Material:  
 (blank):UL94V-2/Black  
 V0:UL94V-0/Black

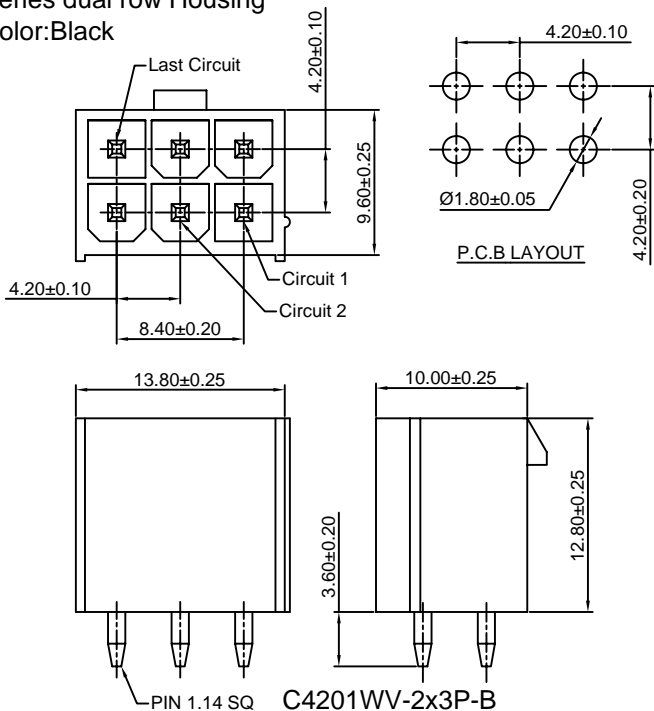
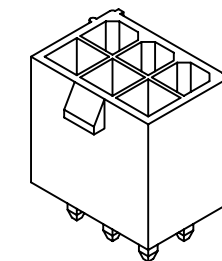
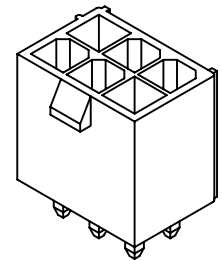

C4201WV-2x3P-B

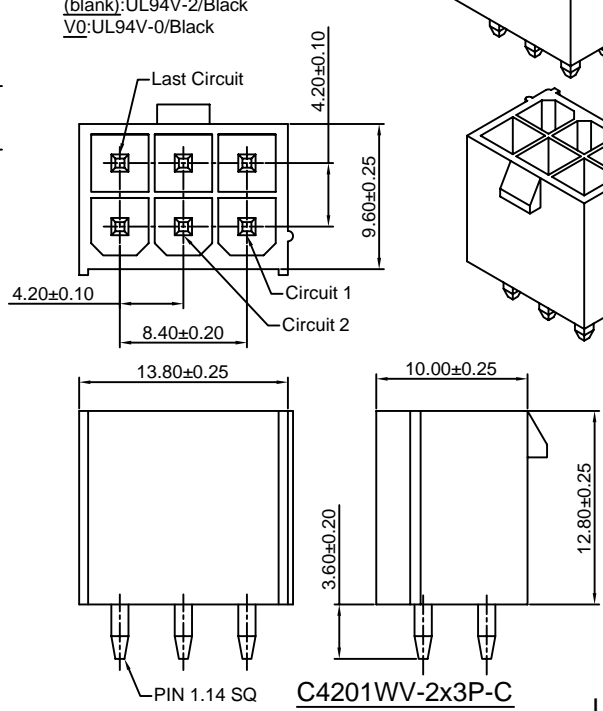

C4201WV-2x3P-C

Unit: mm

## C4201WV-2x4P-A/B

4.20mm pitch Dual Row Housing - Special Type

### Reference Informations:

- \*Material: Pin: Brass/Tin over Nickel  
Insulator: Nylon 66, UL94V-2 or UL94V-0
- \*Mates with CJT C4201HF special type series dual row Housing
- \*Color: Black

### Ordering Information:

- C4201WV-2x4P - \*\*
- |                        |   |
|------------------------|---|
| 1                      | 2 |
| 1. Part No.            |   |
| 2. Material:           |   |
| (blank): UL94V-2/Black |   |
| V0: UL94V-0/Black      |   |

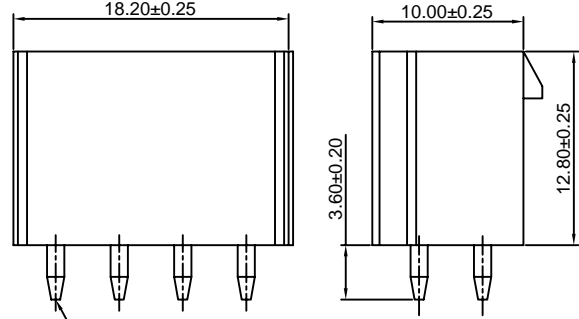
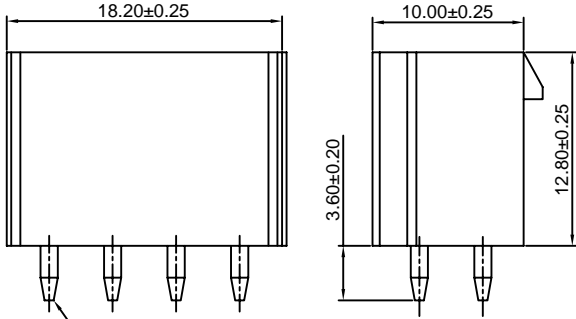
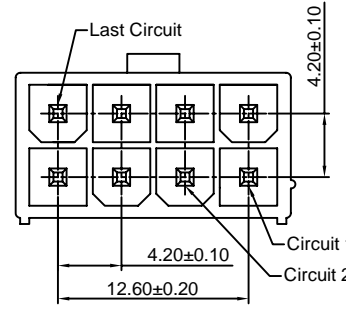
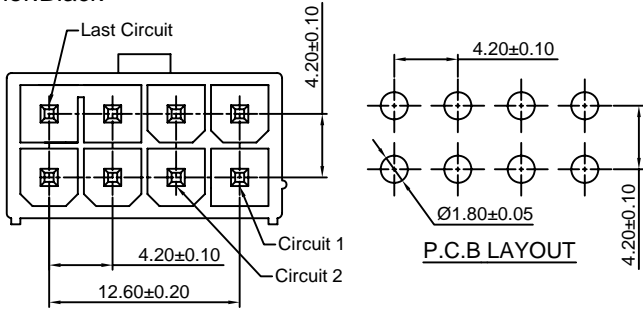
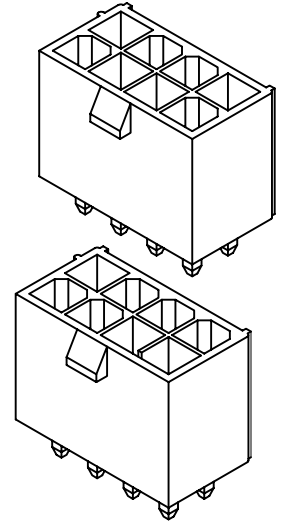

Unit: mm

## C4201WR-F-2x3P-A

4.20mm pitch 90° Dual Row Wafer With Foot - Special TYPE

### Reference Informations:

- \*Material: Pin: Brass/Tin over Nickel  
Insulator: Nylon 66, UL94V-2 or UL94V-0
- \*Mates with CJT C4201HF-2x3P-B special type series dual row Housing
- \*Color: Black

### Ordering Information:

- C4201WR-F-2x3P-A - \*\*
- |                        |   |
|------------------------|---|
| 1                      | 2 |
| 1. Part No.            |   |
| 2. Material:           |   |
| (blank): UL94V-2/Black |   |
| V0: UL94V-0/Black      |   |

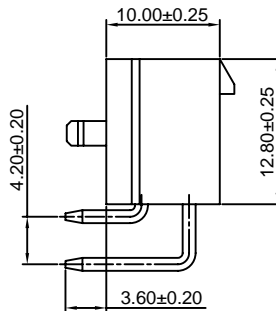
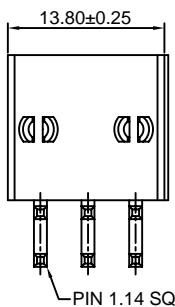
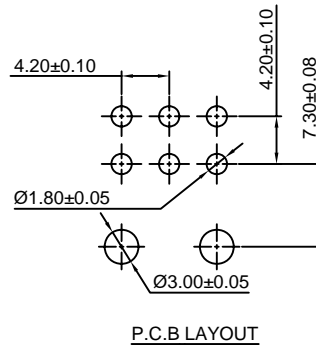
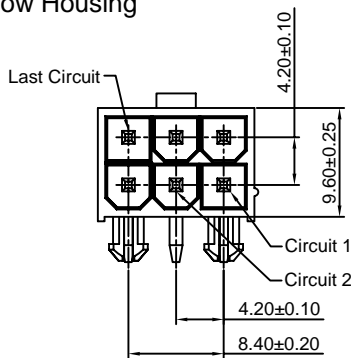
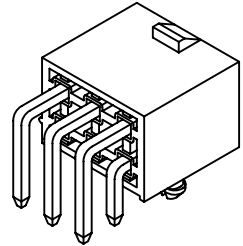

Unit: mm



## C4201HFA-2

4.20mm Pitch Dual Row With Panel Mount Ears Housing

### Reference Informations:

- \*Material:Nylon 66,UL94V-2 or UL94V-0
- \*Suitable CJT C4201F series Terminal
- \*Mates with CJT C4201HMB series dual row Housing or C4201WVA-F1,C4201WR-F1 series dual row Wafer
- \*Color:Natural

### Ordering Information:

C4201HFA-2xXP - \*\*  
1 2

- 1.Part No.
- 2.Material:  
(blank):UL94V-2/Natural  
V0:UL94V-0/White

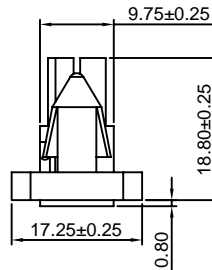
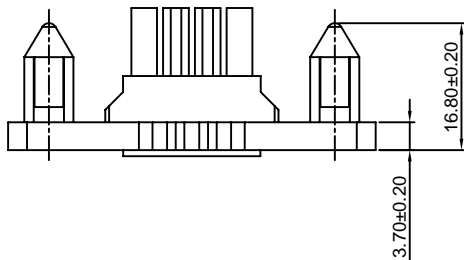
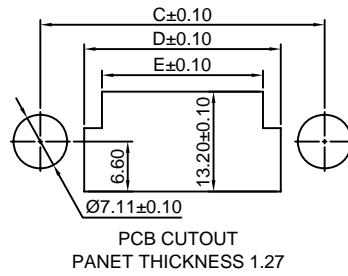
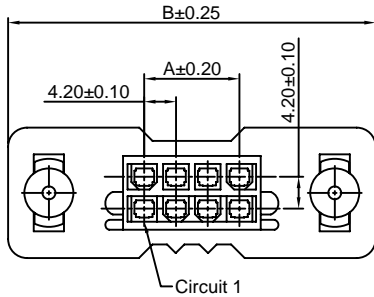
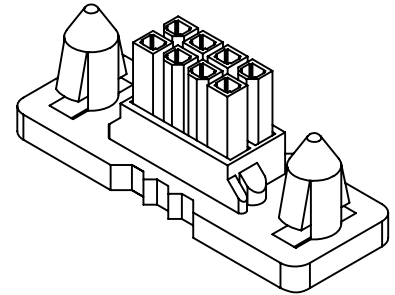

### Ordering Information & Dimensions:

| PART NO.       | Dimensions |        |       |       |       |
|----------------|------------|--------|-------|-------|-------|
|                | A          | B      | C     | D     | E     |
| C4201HFA-2x1P  | -----      | 36.00  | 25.00 | 13.20 | 8.70  |
| C4201HFA-2x2P  | 4.20       | 40.20  | 29.20 | 17.60 | 12.90 |
| C4201HFA-2x3P  | 8.40       | 44.40  | 33.40 | 21.80 | 17.10 |
| C4201HFA-2x4P  | 12.60      | 48.60  | 37.60 | 26.00 | 21.30 |
| C4201HFA-2x5P  | 16.80      | 52.80  | 41.80 | 30.20 | 25.50 |
| C4201HFA-2x6P  | 21.00      | 57.00  | 46.00 | 34.40 | 29.70 |
| C4201HFA-2x7P  | 25.20      | 61.20  | 50.20 | 38.60 | 33.90 |
| C4201HFA-2x8P  | 29.40      | 65.40  | 54.40 | 42.80 | 38.10 |
| C4201HFA-2x9P  | 33.60      | 69.60  | 58.60 | 47.00 | 42.30 |
| C4201HFA-2x10P | 37.80      | 73.80  | 62.80 | 51.20 | 46.50 |
| C4201HFA-2x11P | 42.00      | 78.00  | 67.00 | 55.40 | 50.70 |
| C4201HFA-2x12P | 46.20      | 82.20  | 71.20 | 59.60 | 54.90 |
| C4201HFA-2x18P | 71.40      | 107.40 | 96.40 | 81.50 | 76.78 |

Unit: mm

## C4201HV-2

4.20mm Pitch Vertical Dual Row Receptacle Header

### Reference Informations:

- \*Material:Nylon 66,UL94V-2 or UL94V-0
- \*Mates with CJT C4201HMB series dual row Housing or C4201WVA-F1,C4201WR-F1 series dual row Wafer
- \*Color:Natural

### Ordering Information:

C4201HV-2xXP - \*\*  
1 2

- 1.Part No.
- 2.Material:  
(blank):UL94V-2/Natural  
V0:UL94V-0/White

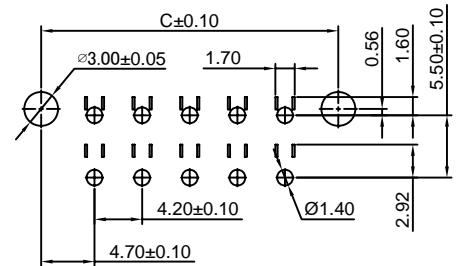

PCB LAYOUT:Component Side  
Recommended PCB Thickness 1.78MAX

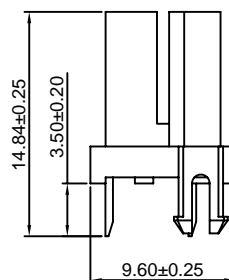
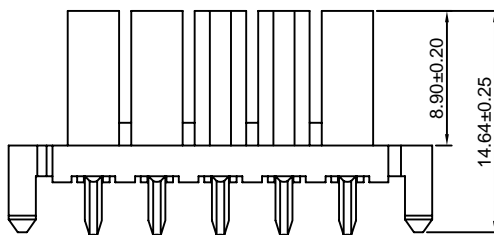
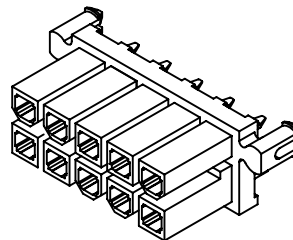
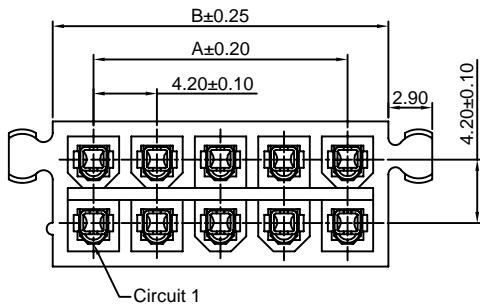

### Ordering Information & Dimensions:

| PART NO.      | Dimensions |       |       |
|---------------|------------|-------|-------|
|               | A          | B     | C     |
| C4201HV-2x1P  | -----      | 5.40  | 9.40  |
| C4201HV-2x2P  | 4.20       | 9.60  | 13.60 |
| C4201HV-2x3P  | 8.40       | 13.80 | 17.80 |
| C4201HV-2x4P  | 12.60      | 18.00 | 22.00 |
| C4201HV-2x5P  | 16.80      | 22.20 | 26.20 |
| C4201HV-2x6P  | 21.00      | 26.40 | 30.40 |
| C4201HV-2x7P  | 25.20      | 30.60 | 34.60 |
| C4201HV-2x8P  | 29.40      | 34.80 | 38.80 |
| C4201HV-2x9P  | 33.60      | 39.00 | 43.00 |
| C4201HV-2x10P | 37.80      | 43.20 | 47.20 |
| C4201HV-2x11P | 42.00      | 47.40 | 51.40 |
| C4201HV-2x12P | 46.20      | 51.60 | 55.60 |
| C4201HV-2x18P | 71.40      | 76.80 | 80.80 |

Unit: mm

### C4201HMB-2

4.20mm Pitch Dual Row Housing With Panel Mount Ears

#### Reference Informations:

- \*Material:Nylon 66,UL94V-2 or UL94V-0
- \*Suitable CJT C4201M series Terminal
- \*Mates with CJT C4201HFA series dual row Housing or C4201HV series dual row Header
- \*Color:Natural

Ordering Information:  
C4201HMB-2xXP - \*\*  
 1  
 2  
 1.Part No.  
 2.Material:  
 (blank):UL94V-2/Natural  
 V0:UL94V-0/White

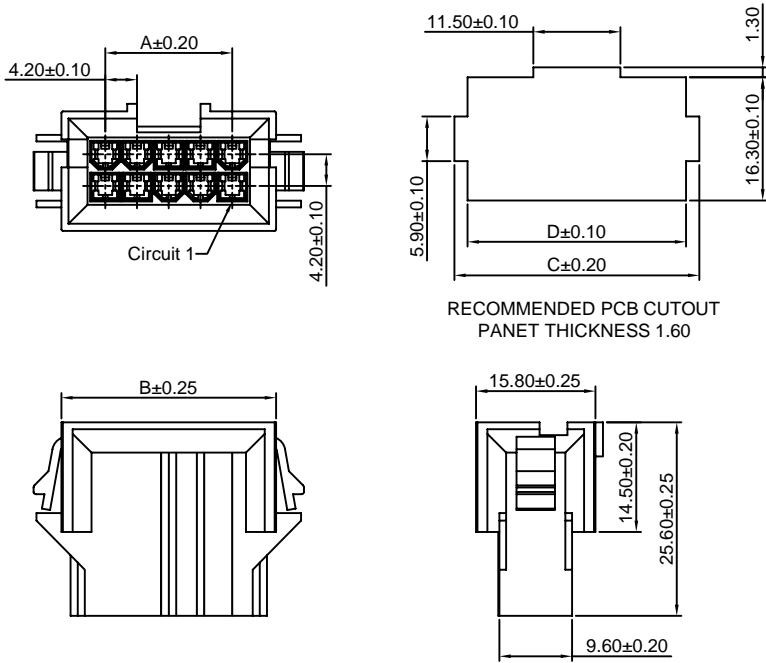
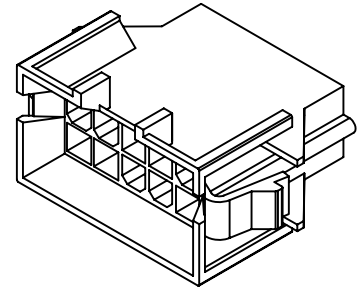

#### Ordering Information & Dimensions:

| PART NO.       | Dimensions |       |       |       |
|----------------|------------|-------|-------|-------|
|                | A          | B     | C     | D     |
| C4201HMB-2x1P  | ----       | 11.60 | 15.60 | 12.10 |
| C4201HMB-2x2P  | 4.20       | 15.80 | 19.80 | 16.30 |
| C4201HMB-2x3P  | 8.40       | 20.00 | 24.00 | 20.50 |
| C4201HMB-2x4P  | 12.60      | 24.20 | 28.20 | 24.70 |
| C4201HMB-2x5P  | 16.80      | 28.40 | 32.40 | 28.90 |
| C4201HMB-2x6P  | 21.00      | 32.60 | 36.60 | 33.10 |
| C4201HMB-2x7P  | 25.20      | 36.80 | 40.80 | 37.30 |
| C4201HMB-2x8P  | 29.40      | 41.00 | 45.00 | 41.50 |
| C4201HMB-2x9P  | 33.60      | 45.20 | 49.20 | 45.70 |
| C4201HMB-2x10P | 37.80      | 49.40 | 53.40 | 49.90 |
| C4201HMB-2x11P | 42.00      | 53.60 | 57.60 | 54.10 |
| C4201HMB-2x12P | 46.20      | 57.80 | 61.80 | 58.30 |
| C4201HMB-2x18P | 71.40      | 83.00 | 87.00 | 83.50 |

Unit: mm

### C4201WVA-F1-2

4.20mm pitch 180° Dual Row Wafer With Foot

#### Reference Informations:

- \*Material:Pin:Brass/Tin over Nickel  
Insulator:Nylon 66,UL94V-2 or UL94V-0
- \*Mates with CJT C4201HFA, C4201HV series dual row Housing
- \*Color:Natural

Ordering Information:  
C4201WVA-F1-2xXP - \*\*  
 1  
 2  
 1.Part No.  
 2.Material:  
 (blank):UL94V-2/Natural  
 V0:UL94V-0/White

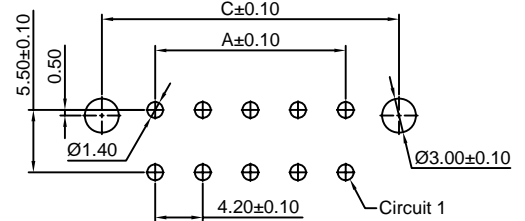

PCB LAYOUT:Component Side  
 Recommended PCB Thickness 1.78MMX

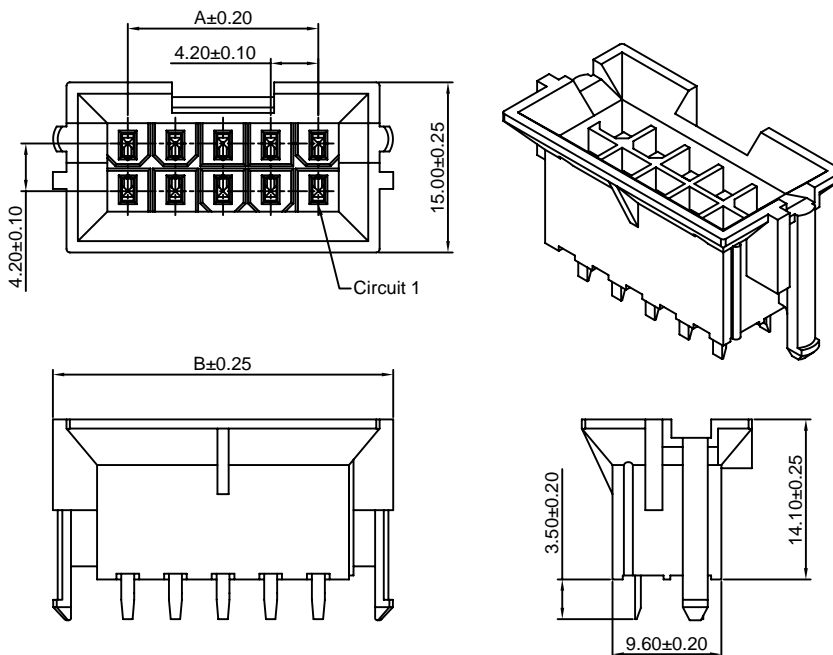

#### Ordering Information & Dimensions:

| PART NO.          | Dimensions |       |       |
|-------------------|------------|-------|-------|
|                   | A          | B     | C     |
| C4201WVA-F1-2x1P  | ----       | 13.20 | 9.40  |
| C4201WVA-F1-2x2P  | 4.20       | 17.40 | 13.60 |
| C4201WVA-F1-2x3P  | 8.40       | 21.60 | 17.80 |
| C4201WVA-F1-2x4P  | 12.60      | 25.80 | 22.00 |
| C4201WVA-F1-2x5P  | 16.80      | 30.00 | 26.20 |
| C4201WVA-F1-2x6P  | 21.00      | 34.20 | 30.40 |
| C4201WVA-F1-2x7P  | 25.20      | 38.40 | 34.60 |
| C4201WVA-F1-2x8P  | 29.40      | 42.60 | 38.80 |
| C4201WVA-F1-2x9P  | 33.60      | 46.80 | 43.00 |
| C4201WVA-F1-2x10P | 37.80      | 51.00 | 47.20 |
| C4201WVA-F1-2x11P | 42.00      | 55.20 | 51.40 |
| C4201WVA-F1-2x12P | 46.20      | 59.40 | 55.60 |
| C4201WVA-F1-2x18P | 71.40      | 84.60 | 80.80 |

Unit: mm

## C4201WR-F1-2

4.20mm pitch 90° Dual Row Wafer With Foot

### Reference Informations:

- \*Material: Pin: Brass/Tin over Nickel  
Insulator: Nylon 66, UL94V-2 or UL94V-0
- \*Mates with CJT C4201HFA, C4201HV series dual row Housing
- \*Color: Natural

### Ordering Information:

C4201WR-F1-2xXP - \*\*  
1 2

- 1. Part No.
- 2. Material:  
(blank): UL94V-2/Natural  
V0: UL94V-0/White

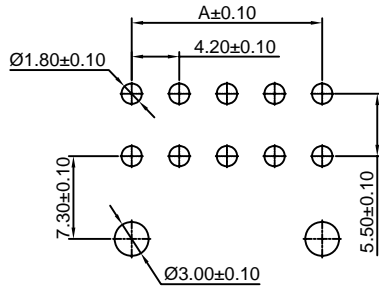
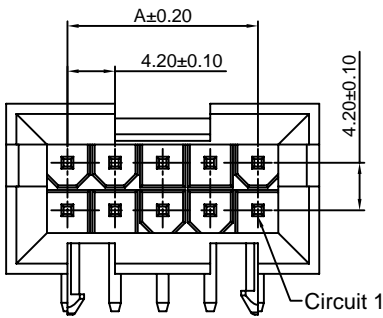
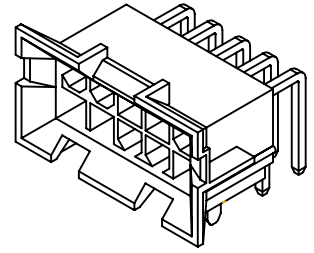

PCB LAYOUT: Component Side  
Recommended PCB Thickness 1.78MAX

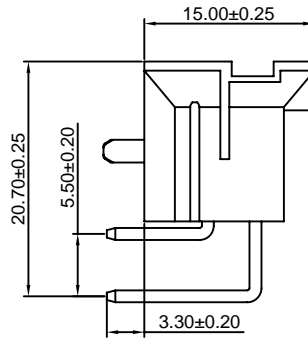
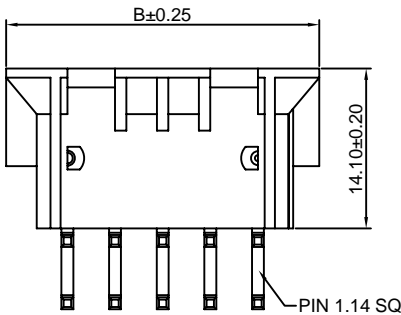

### Ordering Information & Dimensions:

| PART NO.         | Dimensions |       |
|------------------|------------|-------|
|                  | A          | B     |
| C4201WR-F1-2x1P  | -----      | 10.80 |
| C4201WR-F1-2x2P  | 4.20       | 15.00 |
| C4201WR-F1-2x3P  | 8.40       | 19.20 |
| C4201WR-F1-2x4P  | 12.60      | 23.40 |
| C4201WR-F1-2x5P  | 16.80      | 27.60 |
| C4201WR-F1-2x6P  | 21.00      | 31.80 |
| C4201WR-F1-2x7P  | 25.20      | 36.00 |
| C4201WR-F1-2x8P  | 29.40      | 40.20 |
| C4201WR-F1-2x9P  | 33.60      | 44.40 |
| C4201WR-F1-2x10P | 37.80      | 48.60 |
| C4201WR-F1-2x11P | 42.00      | 52.80 |
| C4201WR-F1-2x12P | 46.20      | 57.00 |
| C4201WR-F1-2x18P | 71.40      | 82.20 |

Unit: mm

## C4201WVB-2

4.20mm pitch 180° Dual Row Wafer With Foot

### Reference Informations:

- \*Material: Pin: Phosphor Bronze/Tin over Nickel  
Insulator: Nylon 66, UL94V-0
- \*Mates with CJT C4201HFA, C4201HV series dual row Housing
- \*Color: Black

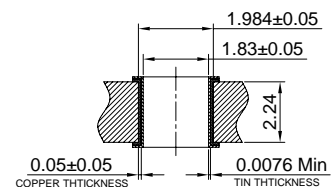
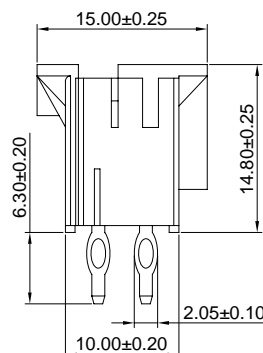
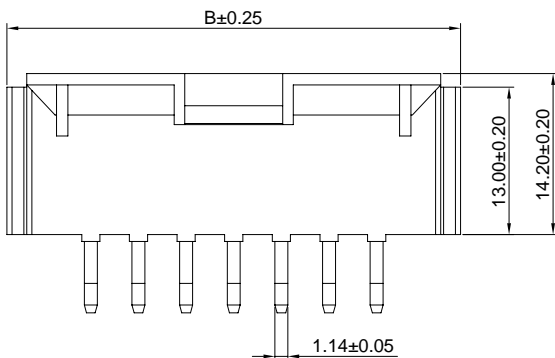
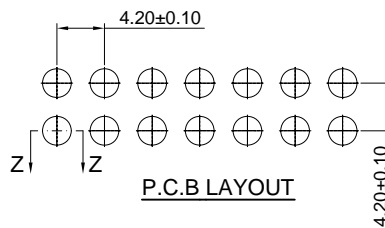
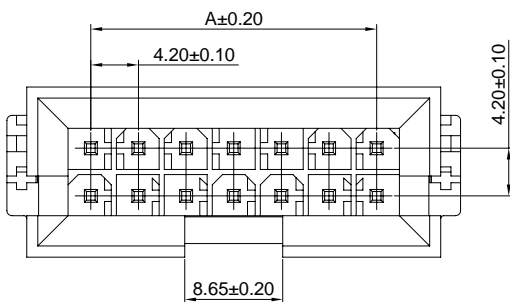
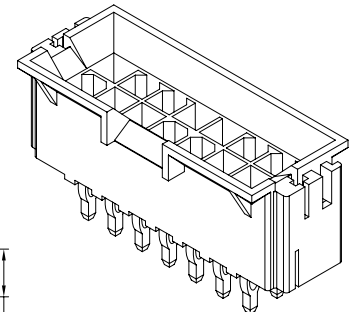

### SEC:Z-Z

### Ordering Information & Dimensions:

| PART NO.       | Dimensions |       |
|----------------|------------|-------|
|                | A          | B     |
| C4201WVB-2x7P  | 25.20      | 40.00 |
| C4201WVB-2x9P  | 33.60      | 48.40 |
| C4201WVB-2x12P | 46.20      | 61.00 |

Unit: mm

## C4201FS-T

4.19mm pitch Crimp Terminal

### Reference Informations:

\*Used in CJT C4201HFS C4201HFSB series Housing

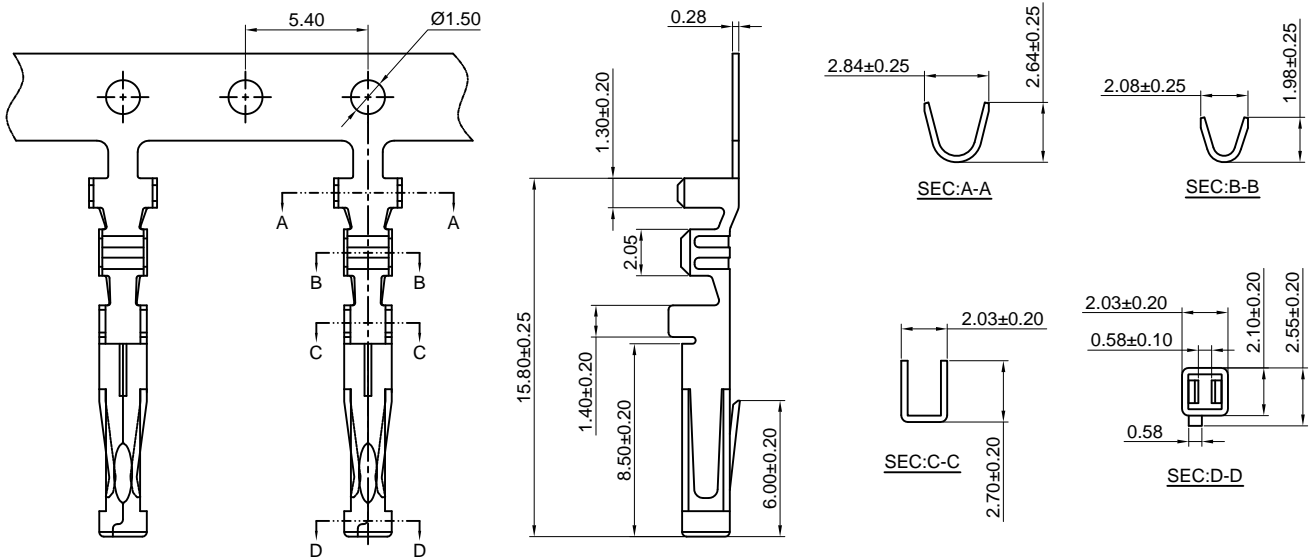

### Ordering information & Specifications:

Unit:mm

| Part NO    | Wire Range | Insulation O.D. | Material        | Finish           | Qty/reel   |
|------------|------------|-----------------|-----------------|------------------|------------|
| C4201FS-TP | AWG#20-#24 | 1.75mm(max)     | Phosphor Bronze | Tin over Nickel  | 10,000 PCS |
| C4201FS-GP | AWG#20-#24 | 1.75mm(max)     | Phosphor Bronze | Gold over Nickel | 10,000 PCS |

Optional Gold plating available but MOQ requested

## C4201FS-T-H

4.19mm pitch Crimp Terminal

### Reference Informations:

\*Used in CJT C4201HFS C4201HFSB series Housing

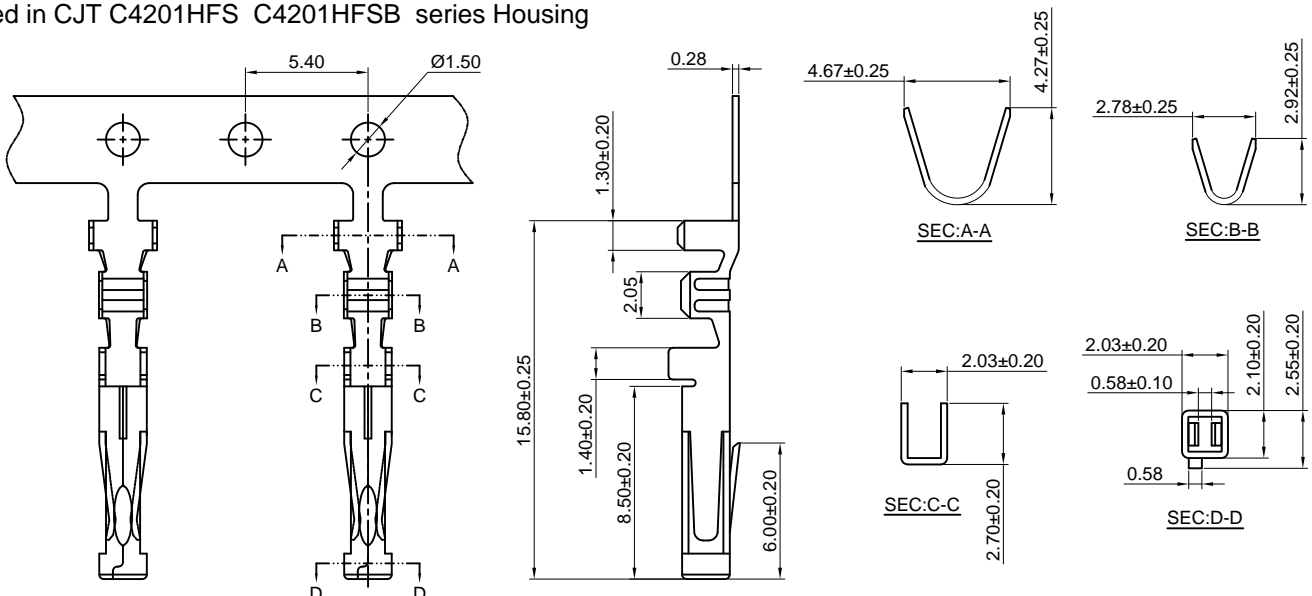

### Ordering information & Specifications:

Unit:mm

| Part NO      | Wire Range | Insulation O.D. | Material        | Finish           | Qty/reel   |
|--------------|------------|-----------------|-----------------|------------------|------------|
| C4201FS-TP-H | AWG#16-#20 | 3.12mm(max)     | Phosphor Bronze | Tin over Nickel  | 10,000 PCS |
| C4201FS-GP-H | AWG#16-#20 | 3.12mm(max)     | Phosphor Bronze | Gold over Nickel | 10,000 PCS |

Optional Gold plating available but MOQ requested

## C4201FS-T-L

4.19mm pitch Crimp Terminal

### Reference Informations:

\*Used in CJT C4201HFS C4201HFSB series Housing

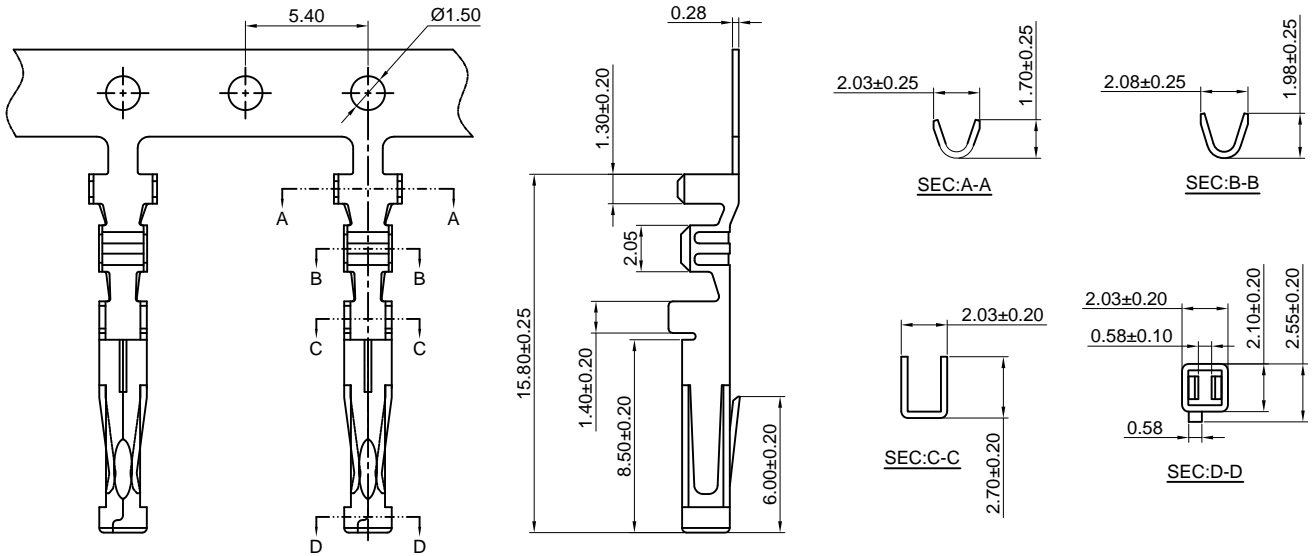

### Ordering information & Specifications:

Unit:mm

| Part NO      | Wire Range | Insulation O.D. | Material        | Finish           | Qty/reel   |
|--------------|------------|-----------------|-----------------|------------------|------------|
| C4201FS-TP-L | AWG#24-#26 | 1.50mm(max)     | Phosphor Bronze | Tin over Nickel  | 10,000 PCS |
| C4201FS-GP-L | AWG#24-#26 | 1.50mm(max)     | Phosphor Bronze | Gold over Nickel | 10,000 PCS |

Optional Gold plating available but MOQ requested

## C4201HFS

4.19mm Pitch Single Row Housing

### Reference Informations:

\*Material:Nylon 66,UL94V-0

\*Suitable CJT C4201FS-T series Terminal

\*Mates with CJT C4201WVS , C4201WRS , C4201WVS-S

, C4201WRS-S series single row Wafer

\*Color:Natural

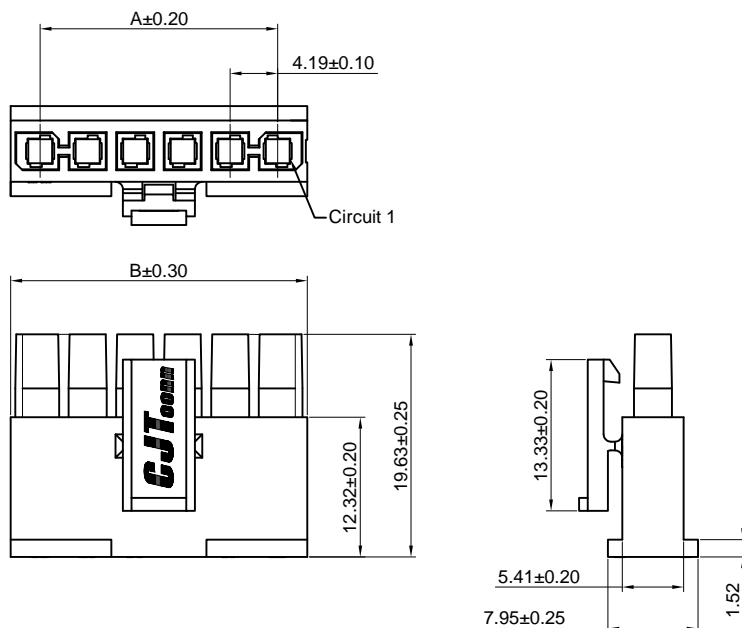

### Ordering Information & Dimensions:

| PART NO.     | Dimensions |       |
|--------------|------------|-------|
|              | A          | B     |
| C4201HFS-2P  | 4.19       | 9.40  |
| C4201HFS-3P  | 8.38       | 13.59 |
| C4201HFS-4P  | 12.57      | 17.78 |
| C4201HFS-5P  | 16.76      | 21.97 |
| C4201HFS-6P  | 21.95      | 26.16 |
| C4201HFS-7P  | 25.14      | 30.35 |
| C4201HFS-8P  | 29.33      | 34.54 |
| C4201HFS-9P  | 33.52      | 38.73 |
| C4201HFS-10P | 37.71      | 42.92 |
| C4201HFS-11P | 41.90      | 47.11 |
| C4201HFS-12P | 46.09      | 51.30 |
| C4201HFS-13P | 50.28      | 55.49 |
| C4201HFS-14P | 54.47      | 59.68 |
| C4201HFS-15P | 58.66      | 63.87 |

Unit: mm

## C4201HFSB

4.19mm Pitch Single Row Housing

### Reference Informations:

- \*Material:Nylon 66,UL94V-0
- \*Suitable CJT C4201FS-T series Terminal
- \*Mates with CJT C4201WVSB , C4201WRSB , C4201WVSB-S , C4201WRSB-S series single row Wafer
- \*Color:Natural

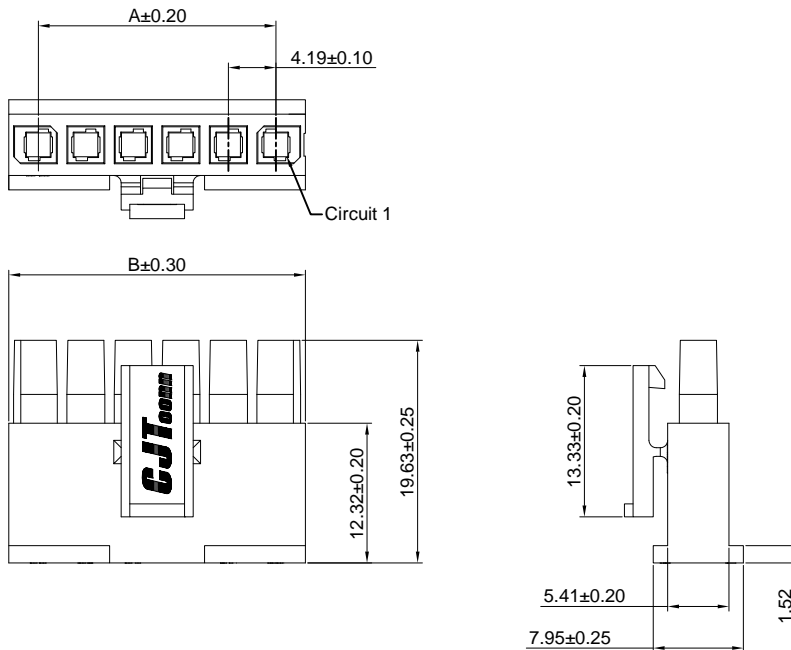

### Ordering Information & Dimensions:

| PART NO.      | Dimensions |       |
|---------------|------------|-------|
|               | A          | B     |
| C4201HFSB-2P  | 4.19       | 9.40  |
| C4201HFSB-3P  | 8.38       | 13.59 |
| C4201HFSB-4P  | 12.57      | 17.78 |
| C4201HFSB-5P  | 16.76      | 21.97 |
| C4201HFSB-6P  | 21.95      | 26.16 |
| C4201HFSB-7P  | 25.14      | 30.35 |
| C4201HFSB-8P  | 29.33      | 34.54 |
| C4201HFSB-9P  | 33.52      | 38.73 |
| C4201HFSB-10P | 37.71      | 42.92 |
| C4201HFSB-11P | 41.90      | 47.11 |
| C4201HFSB-12P | 46.09      | 51.30 |
| C4201HFSB-13P | 50.28      | 55.49 |
| C4201HFSB-14P | 54.47      | 59.68 |
| C4201HFSB-15P | 58.66      | 63.87 |

Unit: mm

## C4201HFS-2

4.19mm Pitch Dual Row Housing

### Reference Informations:

- \*Material:Nylon 66,UL94V-0
- \*Suitable CJT C4201FS-T series Terminal
- \*Mates with CJT C4201WVS , C4201WRS , C4201WVS-S , C4201WRS-S series dual row Wafer
- \*Color:Natural

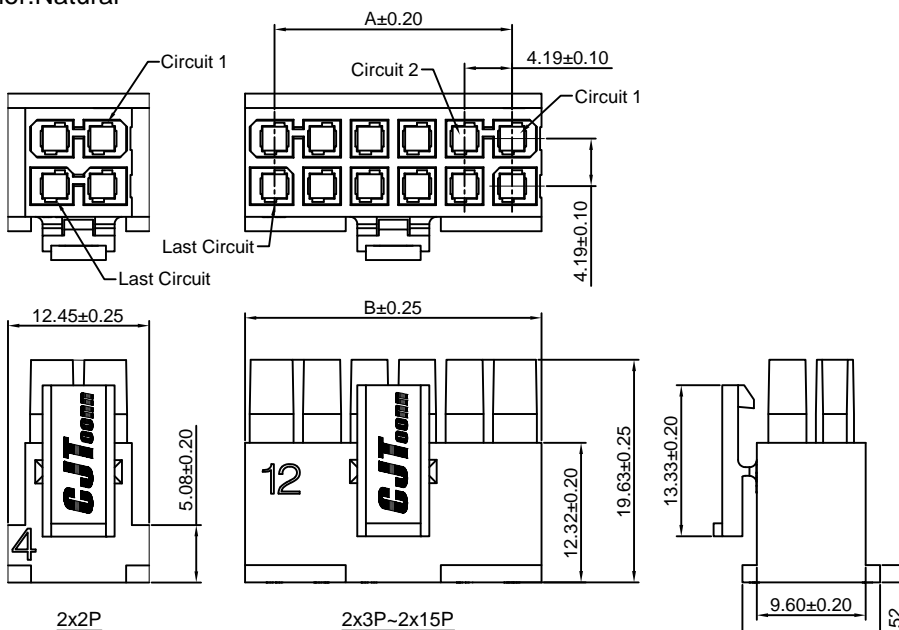

### Ordering Information & Dimensions:

| PART NO.       | Dimensions |       |
|----------------|------------|-------|
|                | A          | B     |
| C4201HFS-2x2P  | 4.19       | 12.45 |
| C4201HFS-2x3P  | 8.38       | 13.59 |
| C4201HFS-2x4P  | 12.57      | 17.78 |
| C4201HFS-2x5P  | 16.76      | 21.97 |
| C4201HFS-2x6P  | 21.95      | 26.16 |
| C4201HFS-2x7P  | 25.14      | 30.35 |
| C4201HFS-2x8P  | 29.33      | 34.54 |
| C4201HFS-2x9P  | 33.52      | 38.73 |
| C4201HFS-2x10P | 37.71      | 42.92 |
| C4201HFS-2x11P | 41.90      | 47.11 |
| C4201HFS-2x12P | 46.09      | 51.30 |
| C4201HFS-2x13P | 50.28      | 55.49 |
| C4201HFS-2x14P | 54.47      | 59.68 |
| C4201HFS-2x15P | 58.66      | 63.87 |

Unit: mm



## C4201HFSB-2

4.19mm Pitch Dual Row Housing

### Reference Informations:

- \*Material:Nylon 66,UL94V-0
- \*Suitable CJT C4201FS-T series Terminal
- \*Mates with CJT C4201WVSB , C4201WRSB ,C4201WVSB-S , C4201WRSB-S series dual row Wafer
- \*Color:Natural

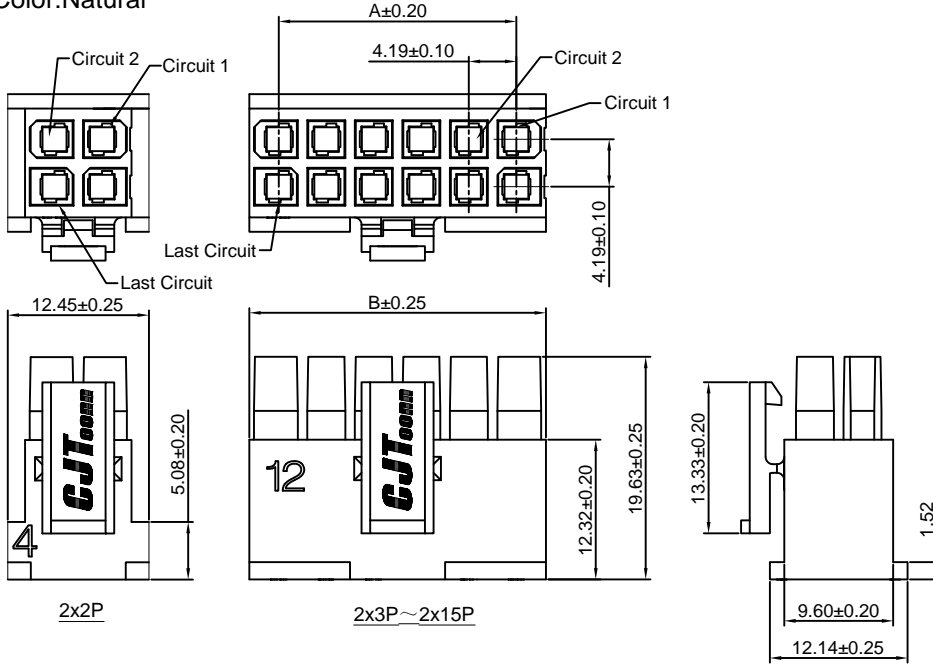

### Ordering Information & Dimensions:

| PART NO.        | Dimensions |       |
|-----------------|------------|-------|
|                 | A          | B     |
| C4201HFSB-2x2P  | 4.19       | 12.45 |
| C4201HFSB-2x3P  | 8.38       | 13.59 |
| C4201HFSB-2x4P  | 12.57      | 17.78 |
| C4201HFSB-2x5P  | 16.76      | 21.97 |
| C4201HFSB-2x6P  | 21.95      | 26.16 |
| C4201HFSB-2x7P  | 25.14      | 30.35 |
| C4201HFSB-2x8P  | 29.33      | 34.54 |
| C4201HFSB-2x9P  | 33.52      | 38.73 |
| C4201HFSB-2x10P | 37.71      | 42.92 |
| C4201HFSB-2x11P | 41.90      | 47.11 |
| C4201HFSB-2x12P | 46.09      | 51.30 |
| C4201HFSB-2x13P | 50.28      | 55.49 |
| C4201HFSB-2x14P | 54.47      | 59.68 |
| C4201HFSB-2x15P | 58.66      | 63.87 |

Unit: mm

## C4201WVS

4.19mm pitch 180° Single Row Wafer

### Reference Informations:

- \*Material:Pin:Brass/Tin over Nickel  
Insulator:LCP , UL94V-0
- \*Suitable CJT C4201FS-T series Terminal
- \*Mates with CJT C4201HFS series single row housing
- \*Color:Black

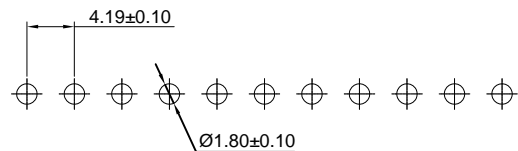

P.C.B LAYOUT

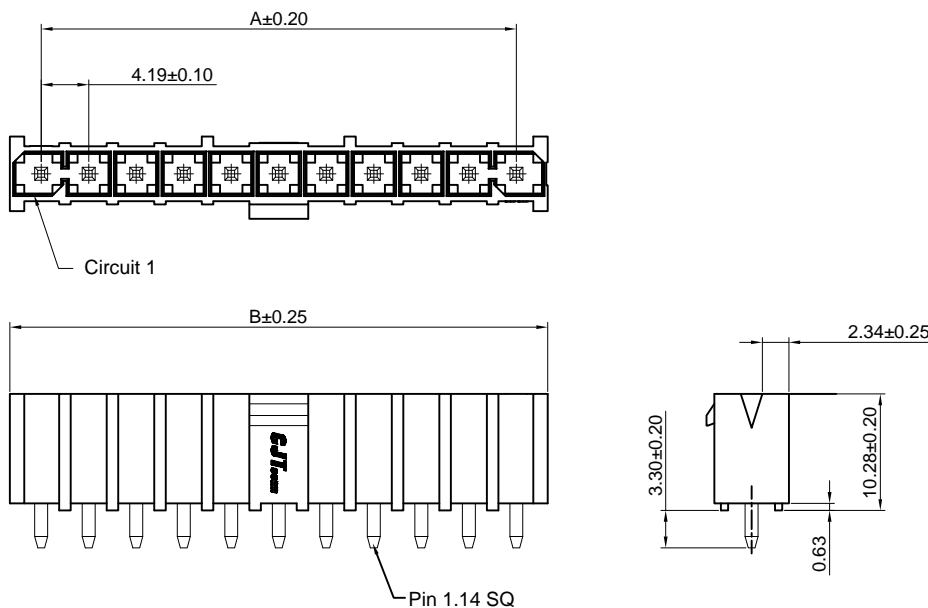

### Ordering Information & Dimensions:

| PART NO.     | Dimensions |       |
|--------------|------------|-------|
|              | A          | B     |
| C4201WVS-2P  | 4.19       | 9.40  |
| C4201WVS-3P  | 8.38       | 13.59 |
| C4201WVS-4P  | 12.57      | 17.78 |
| C4201WVS-5P  | 16.76      | 21.97 |
| C4201WVS-6P  | 21.95      | 26.16 |
| C4201WVS-7P  | 25.14      | 30.35 |
| C4201WVS-8P  | 29.33      | 34.54 |
| C4201WVS-9P  | 33.52      | 38.73 |
| C4201WVS-10P | 37.71      | 42.92 |
| C4201WVS-11P | 41.90      | 47.11 |
| C4201WVS-12P | 46.09      | 51.30 |
| C4201WVS-13P | 50.28      | 55.49 |
| C4201WVS-14P | 54.47      | 59.68 |
| C4201WVS-15P | 58.66      | 63.87 |

Unit: mm

### C4201WVSB

4.19mm pitch 180° Single Row Wafer

#### Reference Informations:

- \*Material: Pin: Brass/Tin over Nickel  
Insulator: LCP, UL94V-0
- \*Suitable CJT C4201FS-T series Terminal
- \*Mates with CJT C4201HFSB series single row housing
- \*Color: Black

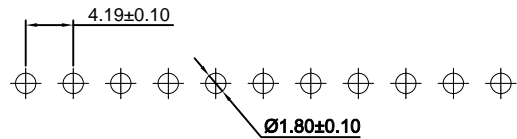
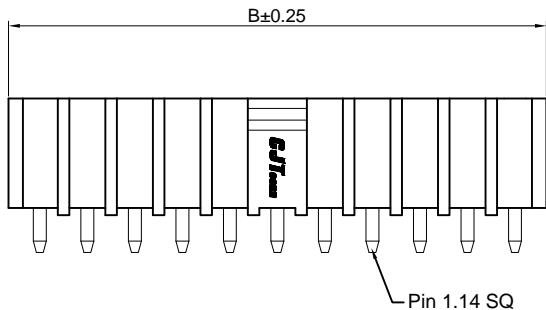
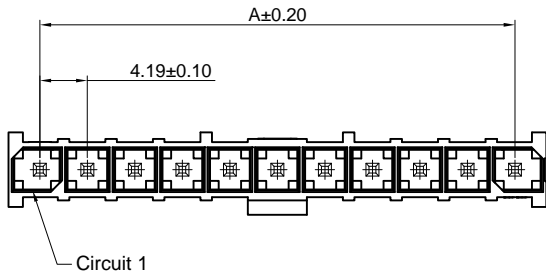

P.C.B LAYOUT

#### Ordering Information & Dimensions:

| PART NO.      | Dimensions |       |
|---------------|------------|-------|
|               | A          | B     |
| C4201WVSB-2P  | 4.19       | 9.40  |
| C4201WVSB-3P  | 8.38       | 13.59 |
| C4201WVSB-4P  | 12.57      | 17.78 |
| C4201WVSB-5P  | 16.76      | 21.97 |
| C4201WVSB-6P  | 21.95      | 26.16 |
| C4201WVSB-7P  | 25.14      | 30.35 |
| C4201WVSB-8P  | 29.33      | 34.54 |
| C4201WVSB-9P  | 33.52      | 38.73 |
| C4201WVSB-10P | 37.71      | 42.92 |
| C4201WVSB-11P | 41.90      | 47.11 |
| C4201WVSB-12P | 46.09      | 51.30 |
| C4201WVSB-13P | 50.28      | 55.49 |
| C4201WVSB-14P | 54.47      | 59.68 |
| C4201WVSB-15P | 58.66      | 63.87 |

Unit: mm

### C4201WVS-S

4.19mm Pitch 180° Single Row Wafer-SMT TYPE

#### Reference Informations:

- \*Material: Pin: Brass/Tin over Nickel  
Insulator: LCP, UL94V-0
- \*Suitable CJT C4201FS-T series Terminal
- \*Mates with CJT C4201HFS series single row housing
- \*Color: Black

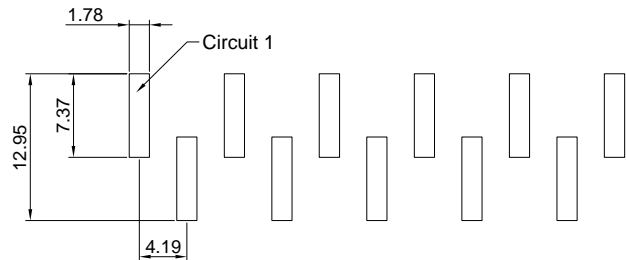
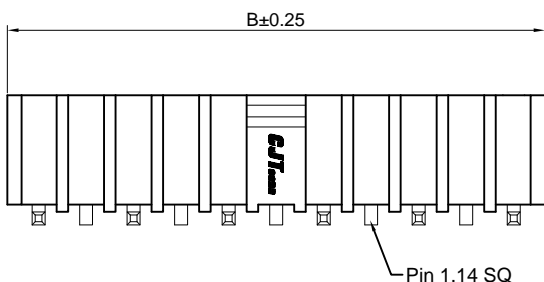
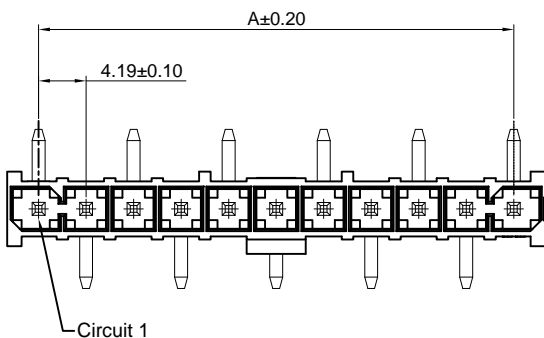

P.C.B LAYOUT

#### Ordering Information & Dimensions:

| PART NO.       | Dimensions |       |
|----------------|------------|-------|
|                | A          | B     |
| C4201WVS-S-2P  | 4.19       | 9.40  |
| C4201WVS-S-3P  | 8.38       | 13.59 |
| C4201WVS-S-4P  | 12.57      | 17.78 |
| C4201WVS-S-5P  | 16.76      | 21.97 |
| C4201WVS-S-6P  | 21.95      | 26.16 |
| C4201WVS-S-7P  | 25.14      | 30.35 |
| C4201WVS-S-8P  | 29.33      | 34.54 |
| C4201WVS-S-9P  | 33.52      | 38.73 |
| C4201WVS-S-10P | 37.71      | 42.92 |
| C4201WVS-S-11P | 41.90      | 47.11 |
| C4201WVS-S-12P | 46.09      | 51.30 |
| C4201WVS-S-13P | 50.28      | 55.49 |
| C4201WVS-S-14P | 54.47      | 59.68 |
| C4201WVS-S-15P | 58.66      | 63.87 |

Unit: mm



### C4201WVSB-S

4.19mm Pitch 180° Single Row Wafer-SMT TYPE

#### Reference Informations:

- \*Material:Pin:Brass/Tin over Nickel  
Insulator:LCP , UL94V-0
- \*Suitable CJT C4201FS-T series Terminal
- \*Mates with CJT C4201HFSB series single row housing
- \*Color:Black

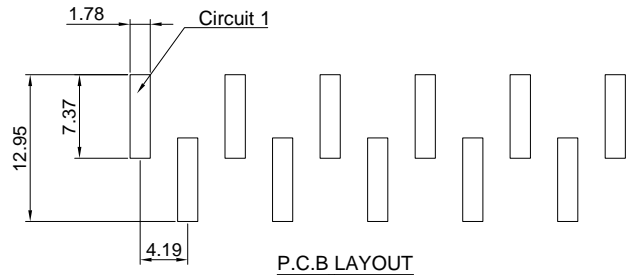
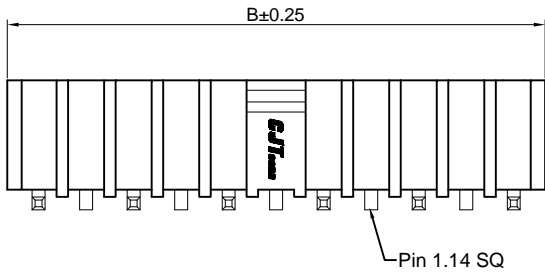
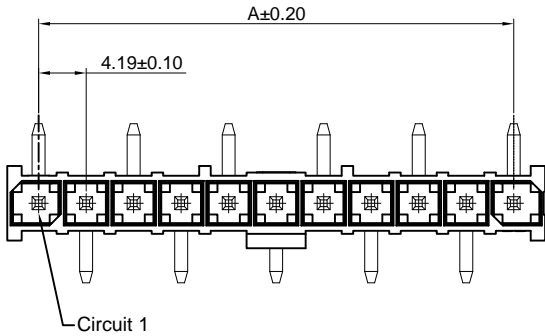

P.C.B LAYOUT

#### Ordering Information & Dimensions:

| PART NO.        | Dimensions |       |
|-----------------|------------|-------|
|                 | A          | B     |
| C4201WVSB-S-2P  | 4.19       | 9.40  |
| C4201WVSB-S-3P  | 8.38       | 13.59 |
| C4201WVSB-S-4P  | 12.57      | 17.78 |
| C4201WVSB-S-5P  | 16.76      | 21.97 |
| C4201WVSB-S-6P  | 21.95      | 26.16 |
| C4201WVSB-S-7P  | 25.14      | 30.35 |
| C4201WVSB-S-8P  | 29.33      | 34.54 |
| C4201WVSB-S-9P  | 33.52      | 38.73 |
| C4201WVSB-S-10P | 37.71      | 42.92 |
| C4201WVSB-S-11P | 41.90      | 47.11 |
| C4201WVSB-S-12P | 46.09      | 51.30 |
| C4201WVSB-S-13P | 50.28      | 55.49 |
| C4201WVSB-S-14P | 54.47      | 59.68 |
| C4201WVSB-S-15P | 58.66      | 63.87 |

Unit: mm

### C4201WRS

4.19mm pitch 90° Single Row Wafer

#### Reference Informations:

- \*Material:Pin:Brass/Tin over Nickel  
Insulator:LCP , UL94V-0
- \*Suitable CJT C4201FS-T series Terminal
- \*Mates with CJT C4201HFS series Single row housing
- \*Color:Black

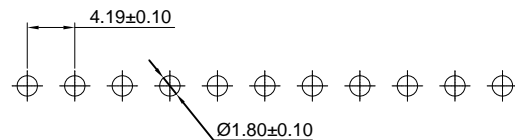
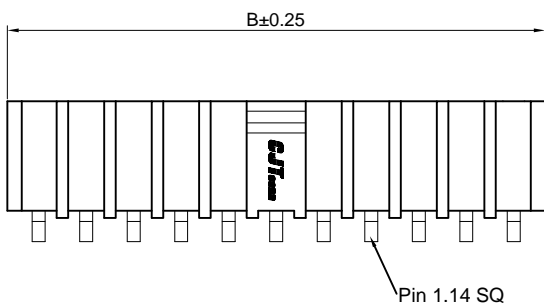
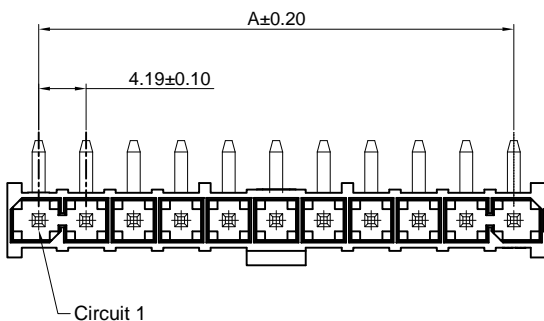

P.C.B LAYOUT

#### Ordering Information & Dimensions:

| PART NO.     | Dimensions |       |
|--------------|------------|-------|
|              | A          | B     |
| C4201WRS-2P  | 4.19       | 9.40  |
| C4201WRS-3P  | 8.38       | 13.59 |
| C4201WRS-4P  | 12.57      | 17.78 |
| C4201WRS-5P  | 16.76      | 21.97 |
| C4201WRS-6P  | 21.95      | 26.16 |
| C4201WRS-7P  | 25.14      | 30.35 |
| C4201WRS-8P  | 29.33      | 34.54 |
| C4201WRS-9P  | 33.52      | 38.73 |
| C4201WRS-10P | 37.71      | 42.92 |
| C4201WRS-11P | 41.90      | 47.11 |
| C4201WRS-12P | 46.09      | 51.30 |
| C4201WRS-13P | 50.28      | 55.49 |
| C4201WRS-14P | 54.47      | 59.68 |
| C4201WRS-15P | 58.66      | 63.87 |

Unit: mm

### C4201WRSB

4.19mm Pitch 90° Single Row Wafer

#### Reference Informations:

- \*Material: Pin: Brass/Tin over Nickel  
Insulator: LCP, UL94V-0
- \*Suitable CJT C4201FS-T series Terminal
- \*Mates with CJT C4201HFSB series single row housing
- \*Color: Black

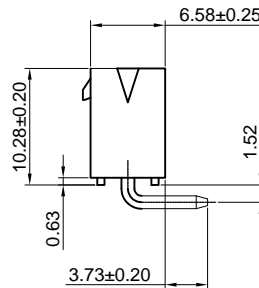
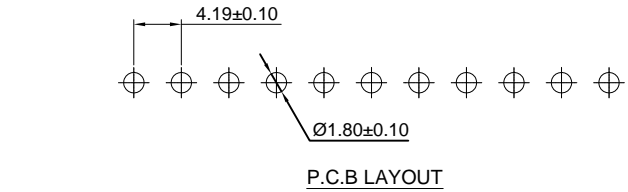
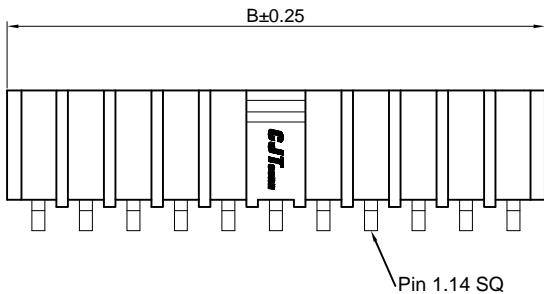
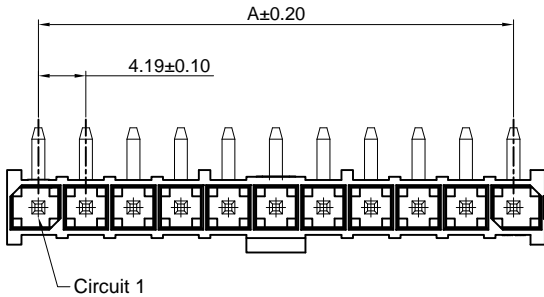

#### Ordering Information & Dimensions:

| PART NO.      | Dimensions |       |
|---------------|------------|-------|
|               | A          | B     |
| C4201WRSB-2P  | 4.19       | 9.40  |
| C4201WRSB-3P  | 8.38       | 13.59 |
| C4201WRSB-4P  | 12.57      | 17.78 |
| C4201WRSB-5P  | 16.76      | 21.97 |
| C4201WRSB-6P  | 21.95      | 26.16 |
| C4201WRSB-7P  | 25.14      | 30.35 |
| C4201WRSB-8P  | 29.33      | 34.54 |
| C4201WRSB-9P  | 33.52      | 38.73 |
| C4201WRSB-10P | 37.71      | 42.92 |
| C4201WRSB-11P | 41.90      | 47.11 |
| C4201WRSB-12P | 46.09      | 51.30 |
| C4201WRSB-13P | 50.28      | 55.49 |
| C4201WRSB-14P | 54.47      | 59.68 |
| C4201WRSB-15P | 58.66      | 63.87 |

Unit: mm

### C4201WVS-2

4.19mm pitch 180° Dual Row Wafer

#### Reference Informations:

- \*Material: Pin: Brass/Tin over Nickel  
Insulator: LCP, UL94V-0
- \*Suitable CJT C4201FS-T series Terminal
- \*Mates with CJT C4201HFS series dual row housing
- \*Color: Black

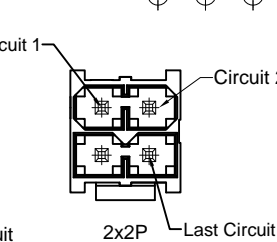
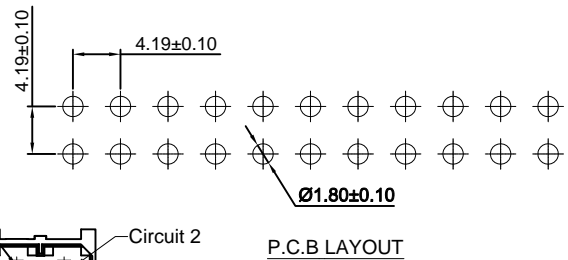
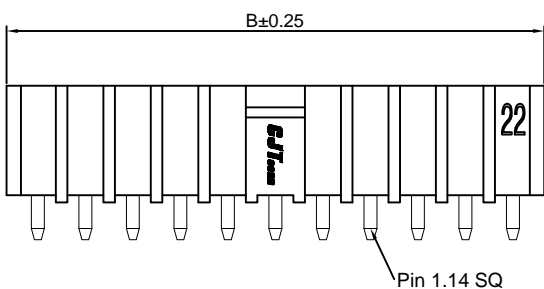
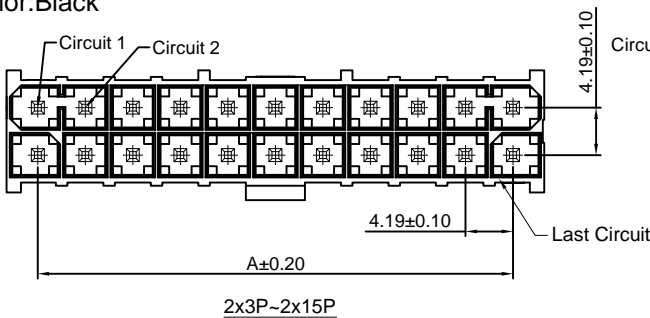

#### Ordering Information & Dimensions:

| PART NO.       | Dimensions |       |
|----------------|------------|-------|
|                | A          | B     |
| C4201WVS-2x2P  | 4.19       | 9.40  |
| C4201WVS-2x3P  | 8.38       | 13.59 |
| C4201WVS-2x4P  | 12.57      | 17.78 |
| C4201WVS-2x5P  | 16.76      | 21.97 |
| C4201WVS-2x6P  | 21.95      | 26.16 |
| C4201WVS-2x7P  | 25.14      | 30.35 |
| C4201WVS-2x8P  | 29.33      | 34.54 |
| C4201WVS-2x9P  | 33.52      | 38.73 |
| C4201WVS-2x10P | 37.71      | 42.92 |
| C4201WVS-2x11P | 41.90      | 47.11 |
| C4201WVS-2x12P | 46.09      | 51.30 |
| C4201WVS-2x13P | 50.28      | 55.49 |
| C4201WVS-2x14P | 54.47      | 59.68 |
| C4201WVS-2x15P | 58.66      | 63.87 |

Unit: mm

## C4201WVSB-2

4.19mm pitch 180° Dual Row Wafer

### Reference Informations:

- \*Material:Pin:Brass/Tin over Nickel  
Insulator:LCP , UL94V-0
- \*Suitable CJT C4201FS-T series Terminal
- \*Mates with CJT C4201HFSB series dual row housing
- \*Color:Black

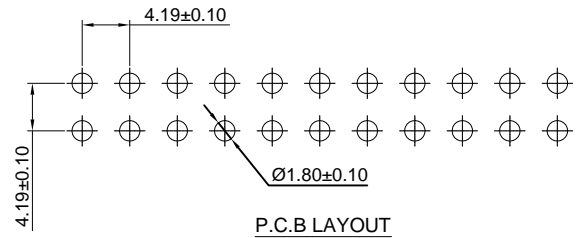
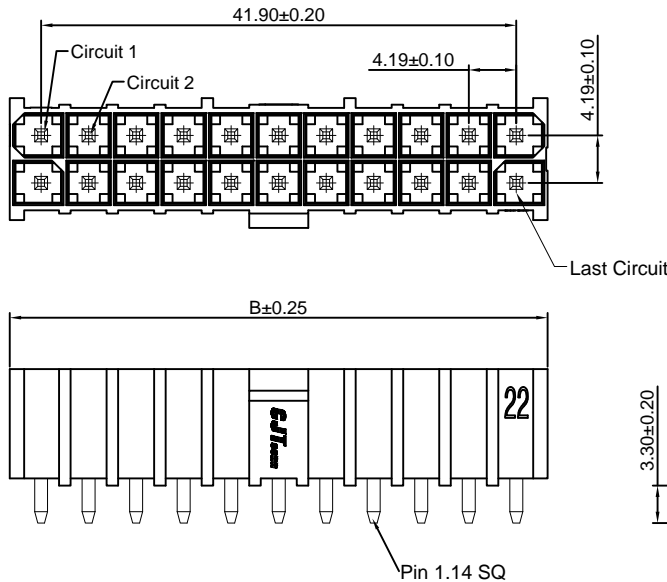

### Ordering Information & Dimensions:

| PART NO.        | Dimensions |       |
|-----------------|------------|-------|
|                 | A          | B     |
| C4201WVSB-2x2P  | 4.19       | 9.40  |
| C4201WVSB-2x3P  | 8.38       | 13.59 |
| C4201WVSB-2x4P  | 12.57      | 17.78 |
| C4201WVSB-2x5P  | 16.76      | 21.97 |
| C4201WVSB-2x6P  | 21.95      | 26.16 |
| C4201WVSB-2x7P  | 25.14      | 30.35 |
| C4201WVSB-2x8P  | 29.33      | 34.54 |
| C4201WVSB-2x9P  | 33.52      | 38.73 |
| C4201WVSB-2x10P | 37.71      | 42.92 |
| C4201WVSB-2x11P | 41.90      | 47.11 |
| C4201WVSB-2x12P | 46.09      | 51.30 |
| C4201WVSB-2x13P | 50.28      | 55.49 |
| C4201WVSB-2x14P | 54.47      | 59.68 |
| C4201WVSB-2x15P | 58.66      | 63.87 |

Unit: mm

## C4201WVS-S-2

4.19mm Pitch 180° Dual Row Wafer-SMT TYPE

### Reference Informations:

- \*Material:Pin:Brass/Tin over Nickel  
Insulator:LCP , UL94V-0
- \*Suitable CJT C4201FS-T series Terminal
- \*Mates with CJT C4201HFS series dual row housing
- \*Color:Black

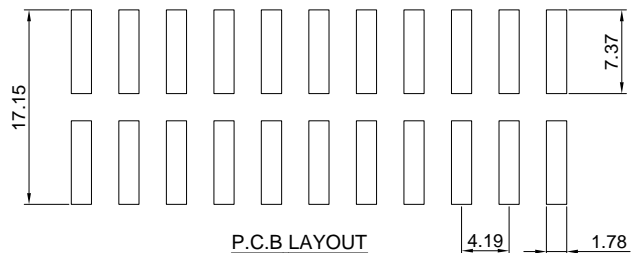
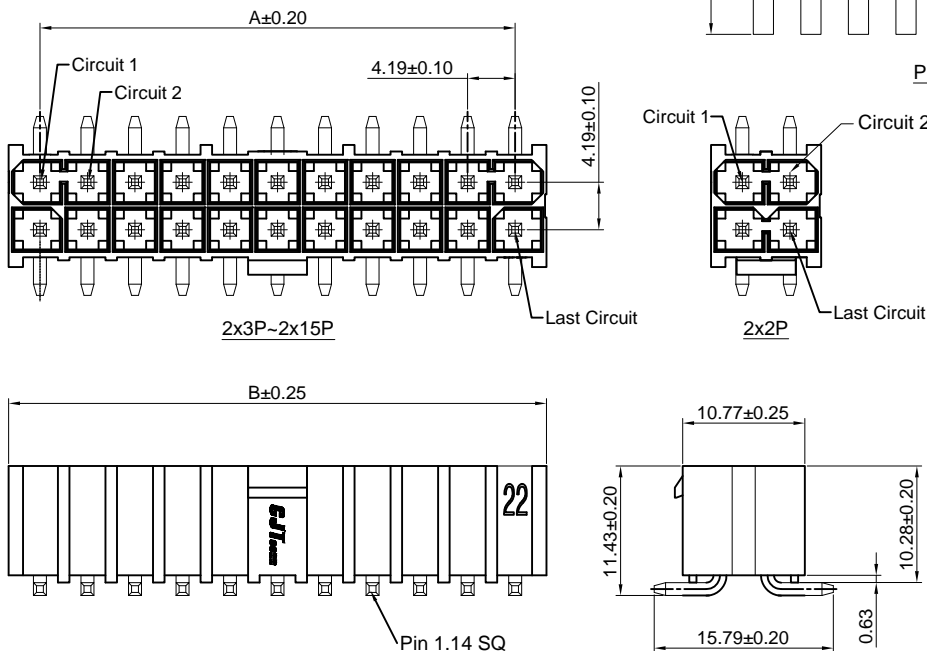

### Ordering Information & Dimensions:

| PART NO.         | Dimensions |       |
|------------------|------------|-------|
|                  | A          | B     |
| C4201WVS-S-2x2P  | 4.19       | 9.40  |
| C4201WVS-S-2x3P  | 8.38       | 13.59 |
| C4201WVS-S-2x4P  | 12.57      | 17.78 |
| C4201WVS-S-2x5P  | 16.76      | 21.97 |
| C4201WVS-S-2x6P  | 21.95      | 26.16 |
| C4201WVS-S-2x7P  | 25.14      | 30.35 |
| C4201WVS-S-2x8P  | 29.33      | 34.54 |
| C4201WVS-S-2x9P  | 33.52      | 38.73 |
| C4201WVS-S-2x10P | 37.71      | 42.92 |
| C4201WVS-S-2x11P | 41.90      | 47.11 |
| C4201WVS-S-2x12P | 46.09      | 51.30 |
| C4201WVS-S-2x13P | 50.28      | 55.49 |
| C4201WVS-S-2x14P | 54.47      | 59.68 |
| C4201WVS-S-2x15P | 58.66      | 63.87 |

Unit: mm

## C4201WVSB-S-2

4.19mm Pitch 180° Dual Row Wafer-SMT TYPE

### Reference Informations:

- \*Material: Pin: Brass/Tin over Nickel  
Insulator: LCP, UL94V-0
- \*Suitable CJT C4201FS-T series Terminal
- \*Mates with CJT C4201HFSB series dual row housing
- \*Color: Black

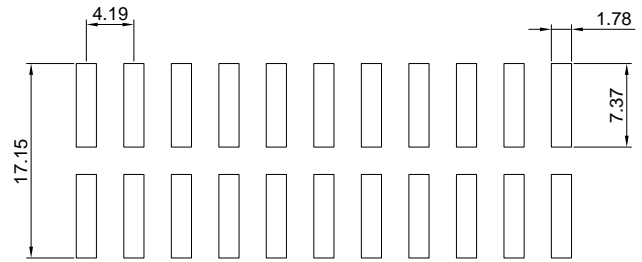
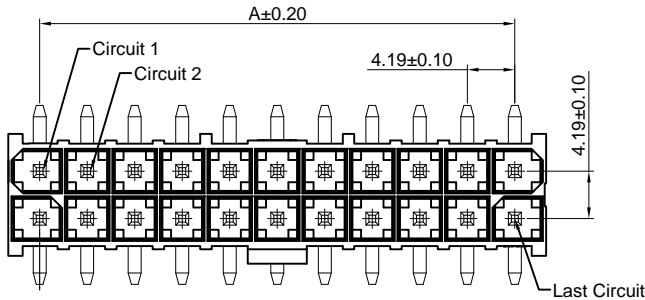

P.C.B LAYOUT

### Ordering Information & Dimensions:

| PART NO.          | Dimensions |       |
|-------------------|------------|-------|
|                   | A          | B     |
| C4201WVSB-S-2x2P  | 4.19       | 9.40  |
| C4201WVSB-S-2x3P  | 8.38       | 13.59 |
| C4201WVSB-S-2x4P  | 12.57      | 17.78 |
| C4201WVSB-S-2x5P  | 16.76      | 21.97 |
| C4201WVSB-S-2x6P  | 21.95      | 26.16 |
| C4201WVSB-S-2x7P  | 25.14      | 30.35 |
| C4201WVSB-S-2x8P  | 29.33      | 34.54 |
| C4201WVSB-S-2x9P  | 33.52      | 38.73 |
| C4201WVSB-S-2x10P | 37.71      | 42.92 |
| C4201WVSB-S-2x11P | 41.90      | 47.11 |
| C4201WVSB-S-2x12P | 46.09      | 51.30 |
| C4201WVSB-S-2x13P | 50.28      | 55.49 |
| C4201WVSB-S-2x14P | 54.47      | 59.68 |
| C4201WVSB-S-2x15P | 58.66      | 63.87 |

Unit: mm

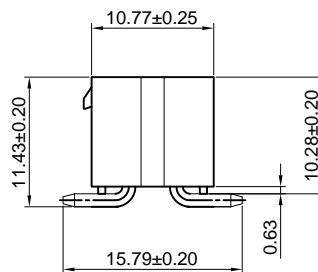
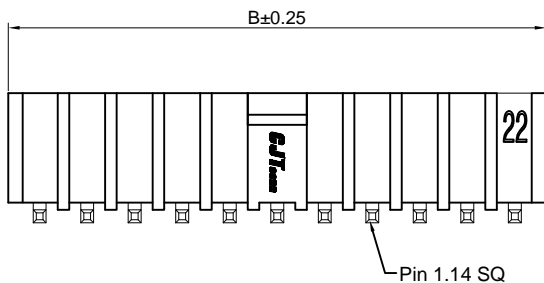

## C4201WRS-2

4.19mm pitch 90° Dual Row Wafer

### Reference Informations:

- \*Material: Pin: Brass/Tin over Nickel  
Insulator: LCP, UL94V-0
- \*Suitable CJT C4201FS-T series Terminal
- \*Mates with CJT C4201HFS series dual row housing
- \*Color: Black

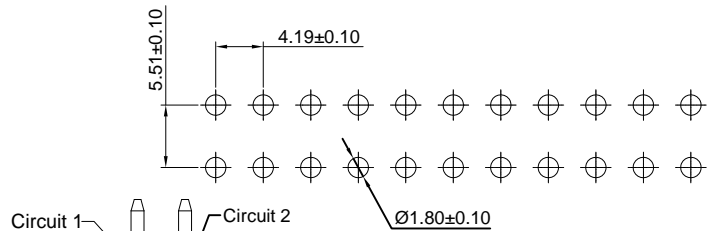
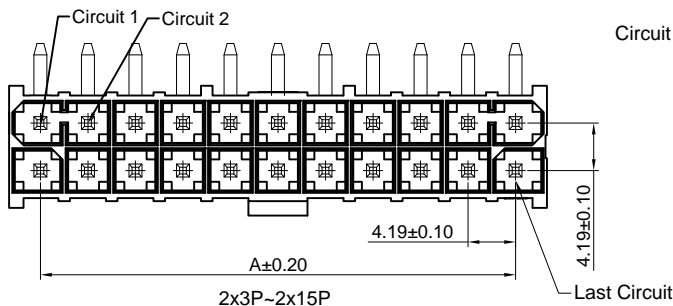

P.C.B LAYOUT

### Ordering Information & Dimensions:

| PART NO.       | Dimensions |       |
|----------------|------------|-------|
|                | A          | B     |
| C4201WRS-2x2P  | 4.19       | 9.40  |
| C4201WRS-2x3P  | 8.38       | 13.59 |
| C4201WRS-2x4P  | 12.57      | 17.78 |
| C4201WRS-2x5P  | 16.76      | 21.97 |
| C4201WRS-2x6P  | 21.95      | 26.16 |
| C4201WRS-2x7P  | 25.14      | 30.35 |
| C4201WRS-2x8P  | 29.33      | 34.54 |
| C4201WRS-2x9P  | 33.52      | 38.73 |
| C4201WRS-2x10P | 37.71      | 42.92 |
| C4201WRS-2x11P | 41.90      | 47.11 |
| C4201WRS-2x12P | 46.09      | 51.30 |
| C4201WRS-2x13P | 50.28      | 55.49 |
| C4201WRS-2x14P | 54.47      | 59.68 |
| C4201WRS-2x15P | 58.66      | 63.87 |

Unit: mm

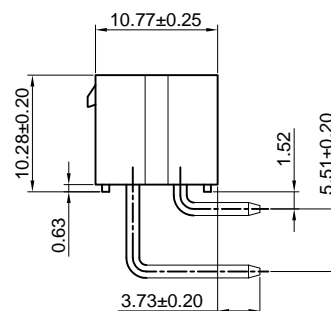
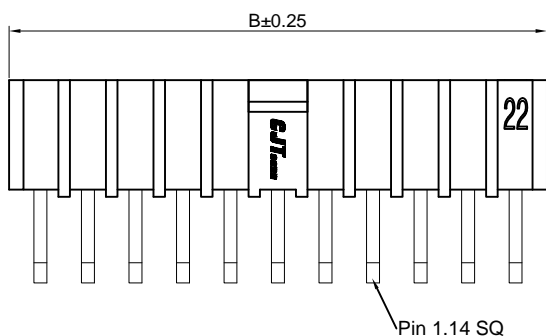

## C4201WRSB-2

4.19mm Pitch 90° Dual Row Wafer

### Reference Informations:

- \*Material: Pin: Brass/Tin over Nickel  
Insulator: LCP, UL94V-0
- \*Suitable CJT C4201FS-T series Terminal
- \*Mates with CJT C4201HFSB series dual row housing
- \*Color: Black

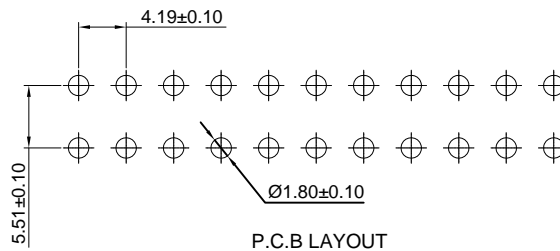
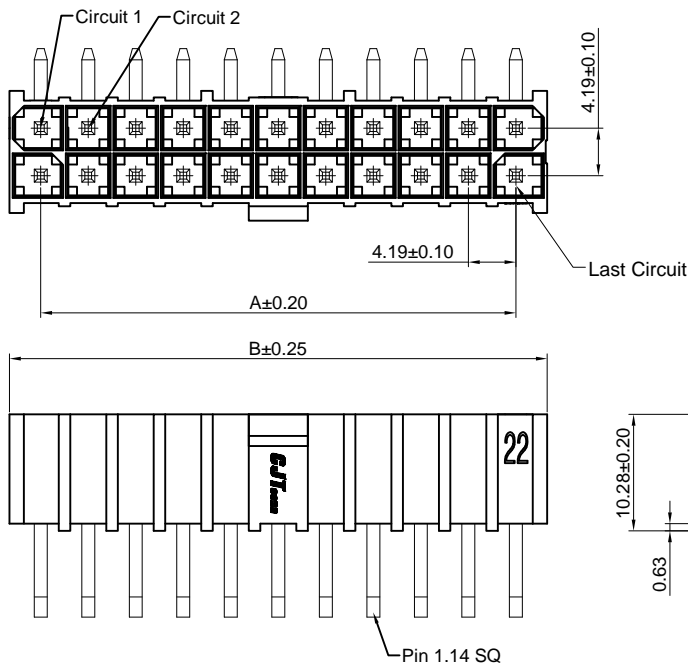

P.C.B LAYOUT

### Ordering Information & Dimensions:

| PART NO.        | Dimensions |       |
|-----------------|------------|-------|
|                 | A          | B     |
| C4201WRSB-2x2P  | 4.19       | 9.40  |
| C4201WRSB-2x3P  | 8.38       | 13.59 |
| C4201WRSB-2x4P  | 12.57      | 17.78 |
| C4201WRSB-2x5P  | 16.76      | 21.97 |
| C4201WRSB-2x6P  | 21.95      | 26.16 |
| C4201WRSB-2x7P  | 25.14      | 30.35 |
| C4201WRSB-2x8P  | 29.33      | 34.54 |
| C4201WRSB-2x9P  | 33.52      | 38.73 |
| C4201WRSB-2x10P | 37.71      | 42.92 |
| C4201WRSB-2x11P | 41.90      | 47.11 |
| C4201WRSB-2x12P | 46.09      | 51.30 |
| C4201WRSB-2x13P | 50.28      | 55.49 |
| C4201WRSB-2x14P | 54.47      | 59.68 |
| C4201WRSB-2x15P | 58.66      | 63.87 |

Unit: mm

## X-ON Electronics

Largest Supplier of Electrical and Electronic Components

*Click to view similar products for [Headers & Wire Housings](#) category:*

*Click to view products by [Changjiang](#) manufacturer:*

Other Similar products are found below :

[57102-F02-18ULF](#) [58102-G61-06LF](#) [0009485154](#) [009176003701906](#) [0050291907](#) [00-9021-0611-00-339](#) [02.125.8002.8](#) [609-3404](#) [61062-3](#)  
[622-0430](#) [622-3653LF](#) [63453-116](#) [636-1030](#) [636-1427](#) [636-3427](#) [636-4007](#) [641938-9](#) [644827-2](#) [65495-038](#) [65692-001LF](#) [65781-018](#)  
[65781-047](#) [65817-010LF](#) [65817-015LF](#) [66207-023LF](#) [67016-026LF](#) [67095-007LF](#) [68631-112](#) [68645-018](#) [68648-049](#) [699319-000](#)  
[70.362.1628.0](#) [70-4210](#) [70-4226B](#) [70-4853B](#) [707-5020](#) [707-5028](#) [71.350.2428.0](#) [71961-016LF](#) [733-134](#) [754199-000](#) [760-3052](#) [787-8014-00](#)  
[FCN-367T-T012/H](#) [80.063.4001.1](#) [800-90-001-10-001000](#) [800-90-010-10-002000](#) [801-43-002-10-013000](#) [801-43-006-10-002000](#)  
[803-41-018-10-001000](#)