

Specifications

- Current rating: 9A AC, DC Max
- Voltage rating: 600V AC, DC
- Temperature range: -40°C ~ +105°C
- Contact resistance: 10mΩ Max.
- Insulation resistance: 1000MΩ Min.
- Withstanding voltage: 1500V AC/minute
- *Compliant with RoHS and REACH*
- *Meet the HF/Halogen Free, GWT/Glow wire Test (IEC60335-1) request, need to customize*
- *Contact CJT for details*

Standards



Panel hole layout

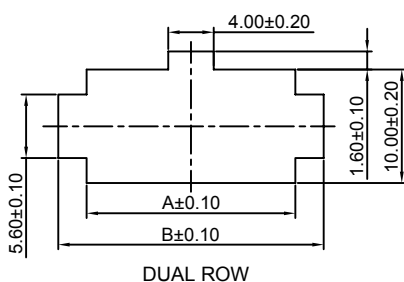

DUAL ROW

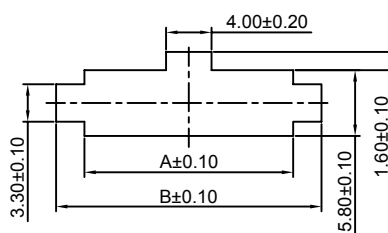

SINGLE ROW

PART NO.		Dimensions	
SINGLE ROW	DUAL ROW	A	B
-----	C4201HM-2x1P	5.80	10.80
C4201HM-2P	C4201HM-2x2P	10.00	15.00
C4201HM-3P	C4201HM-2x3P	14.20	19.20
C4201HM-4P	C4201HM-2x4P	18.40	23.40
C4201HM-5P	C4201HM-2x5P	22.60	27.60
C4201HM-6P	C4201HM-2x6P	26.80	31.80
C4201HM-7P	C4201HM-2x7P	31.00	36.00
C4201HM-8P	C4201HM-2x8P	35.20	40.20
C4201HM-9P	C4201HM-2x9P	39.40	44.40
C4201HM-10P	C4201HM-2x10P	43.60	48.60
C4201HM-11P	C4201HM-2x11P	47.80	52.80
C4201HM-12P	C4201HM-2x12P	52.00	57.00

Unit:mm

Assembly layout

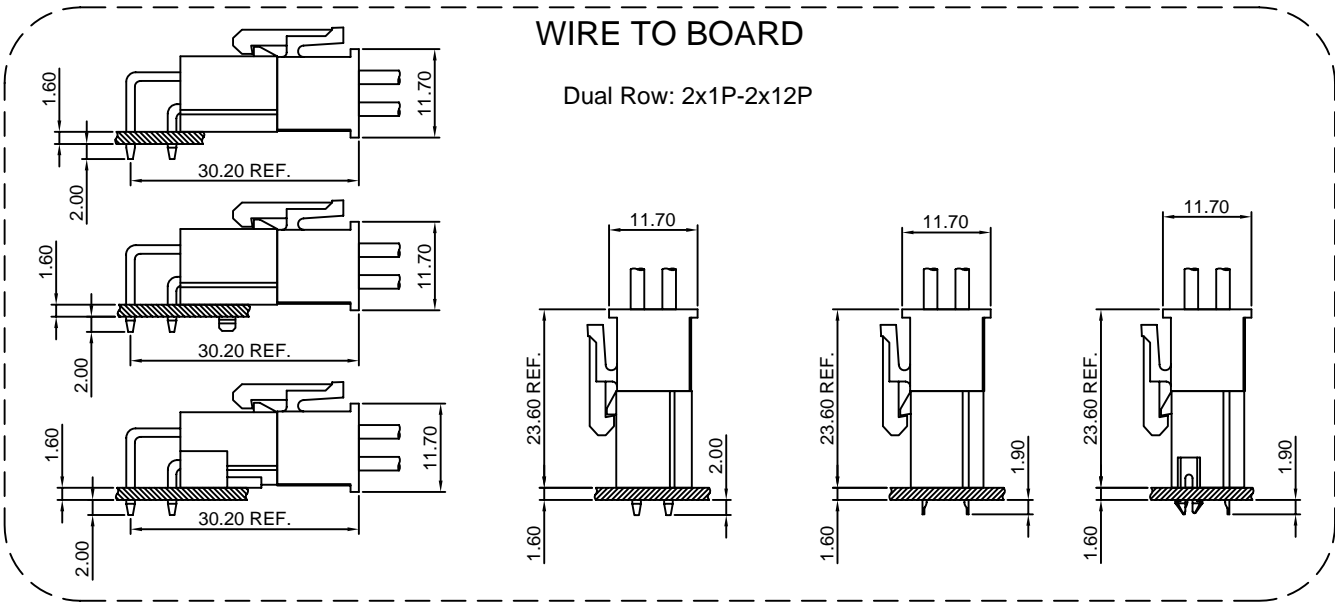
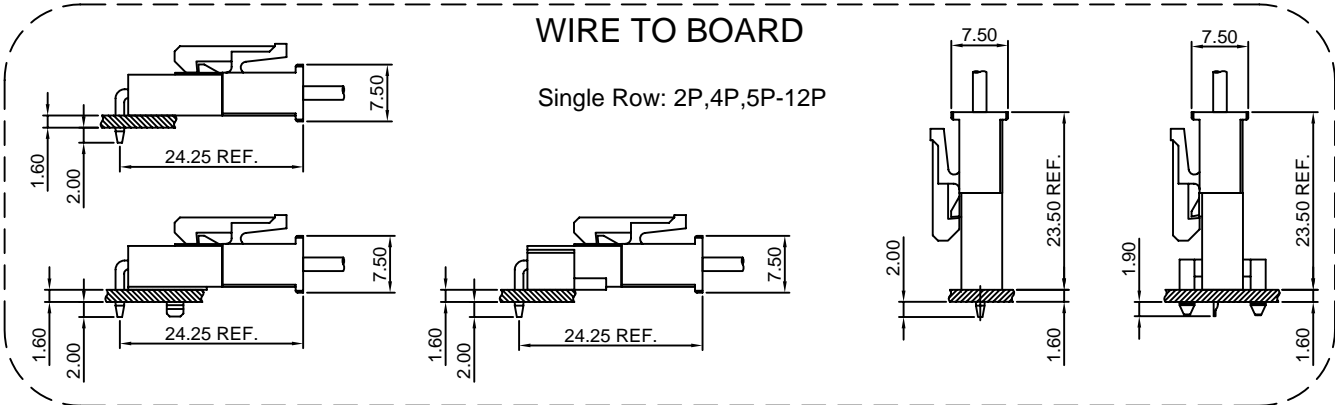
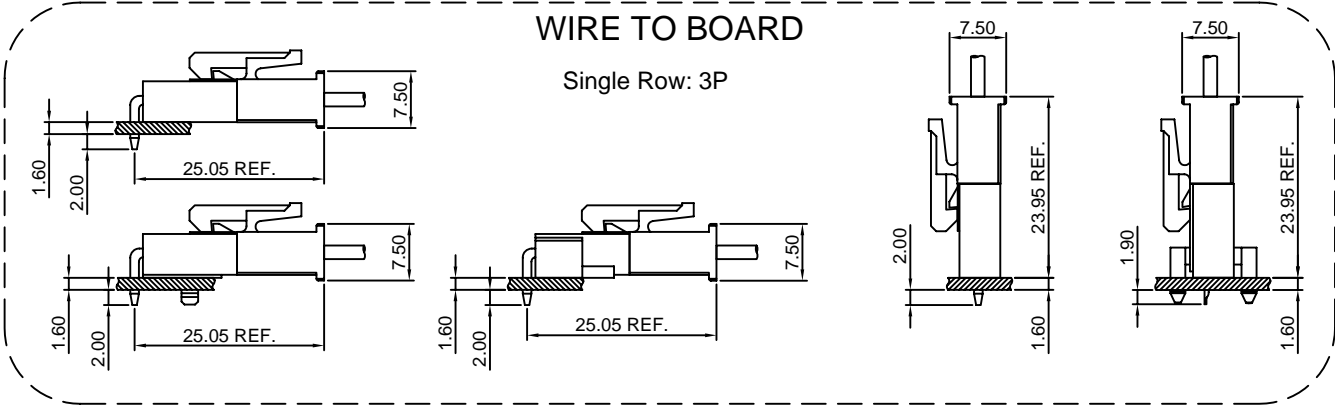
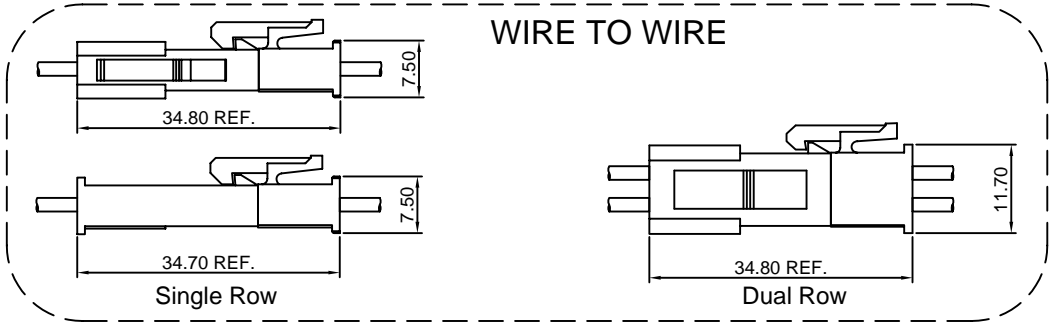

C4201HF



C4201HF

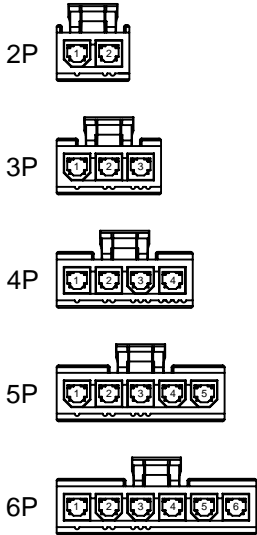

C4201HM

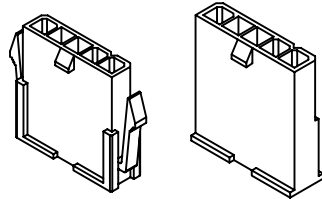

C4201HM C4201HMA

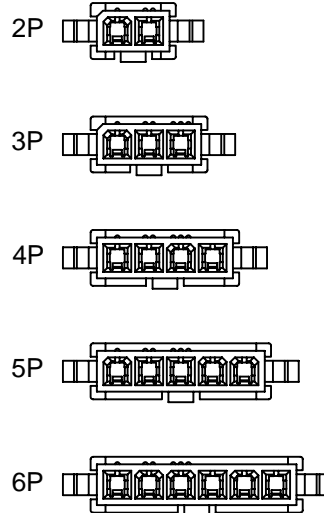

C4201WV C4201WVA-F

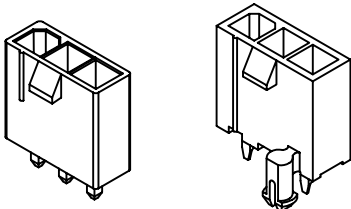

C4201WV C4201WVA-F

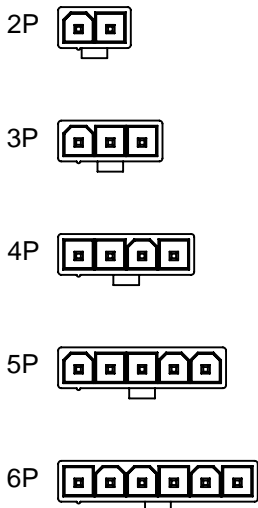

C4201WR C4201WR-E

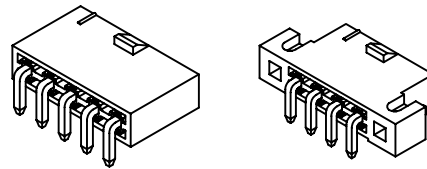

C4201WR C4201WR-E

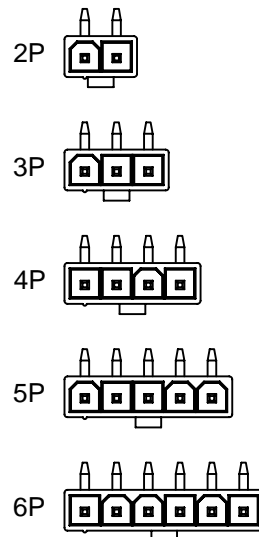

C4201HF-2

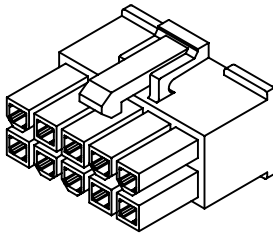

C4201HF-2

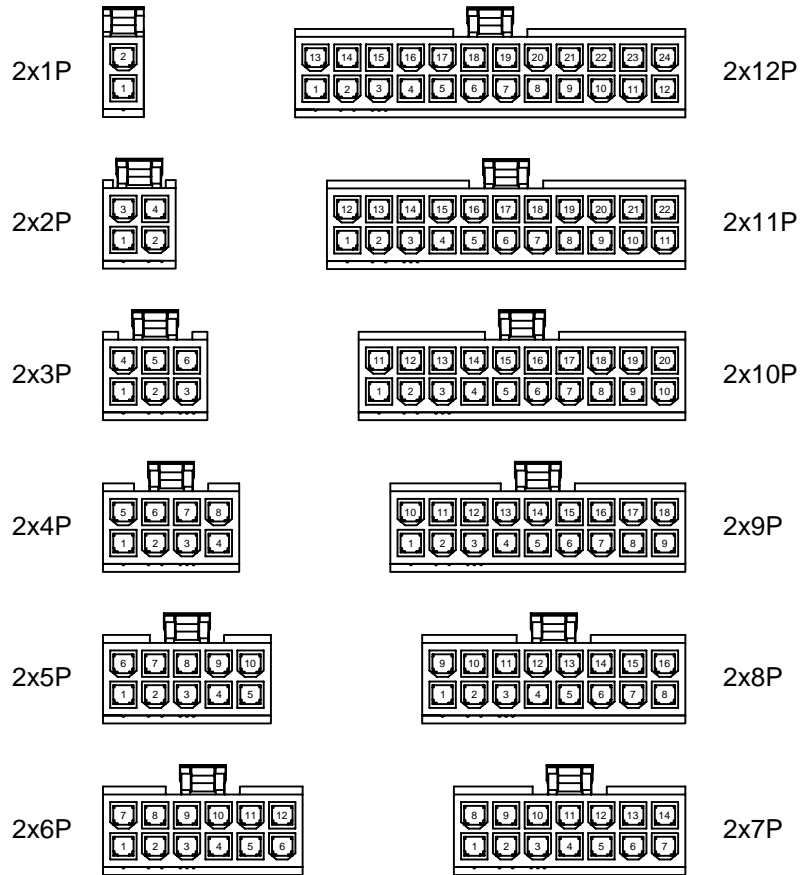

C4201HM-2 C4201HMA-2

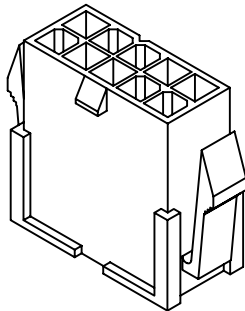

C4201HM-2

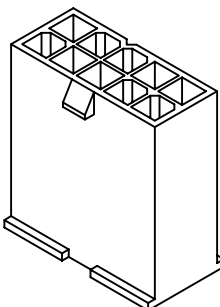

C4201HMA-2

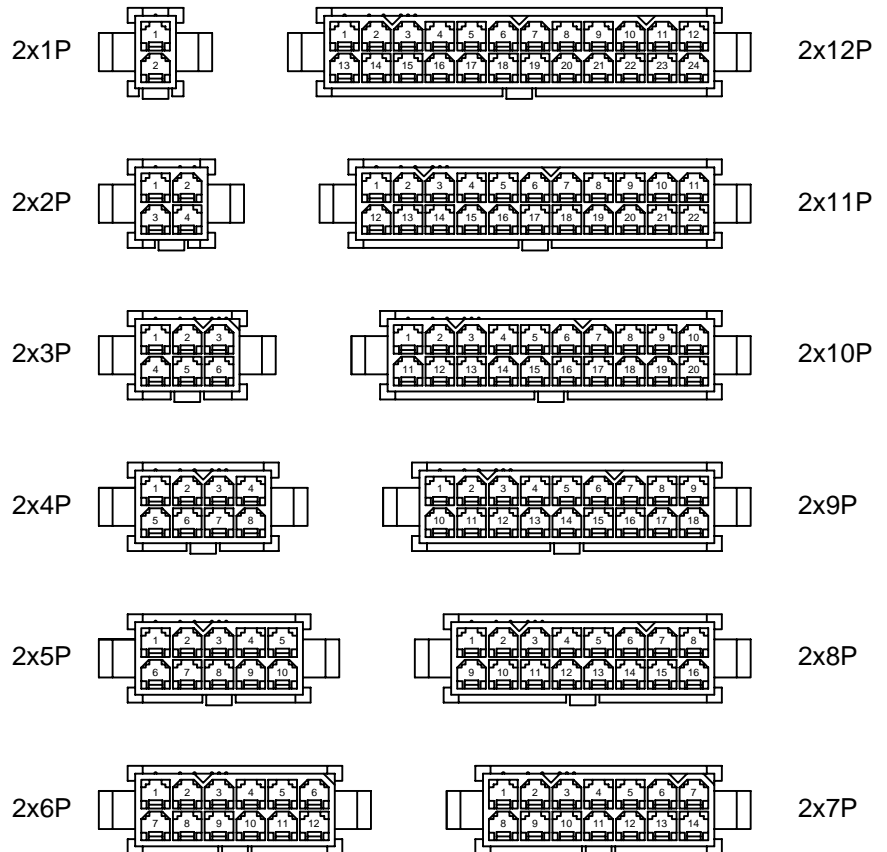

C4201WV-2 C4201WVA-2 C4201WVA-F-2

C4201WV-2		2x1P			2x12P
		2x2P			2x11P
C4201WVA-2		2x3P			2x10P
		2x4P			2x9P
C4201WVA-F-2		2x5P			2x8P
		2x6P			2x7P

C4201WR-2 C4201WR-E-2 C4201WR-F-2

C4201WR-2		2x1P			2x12P
		2x2P			2x11P
C4201WR-E-2		2x3P			2x10P
		2x4P			2x9P
C4201WR-F-2		2x5P			2x8P
		2x6P			2x7P

C4201HFA-2

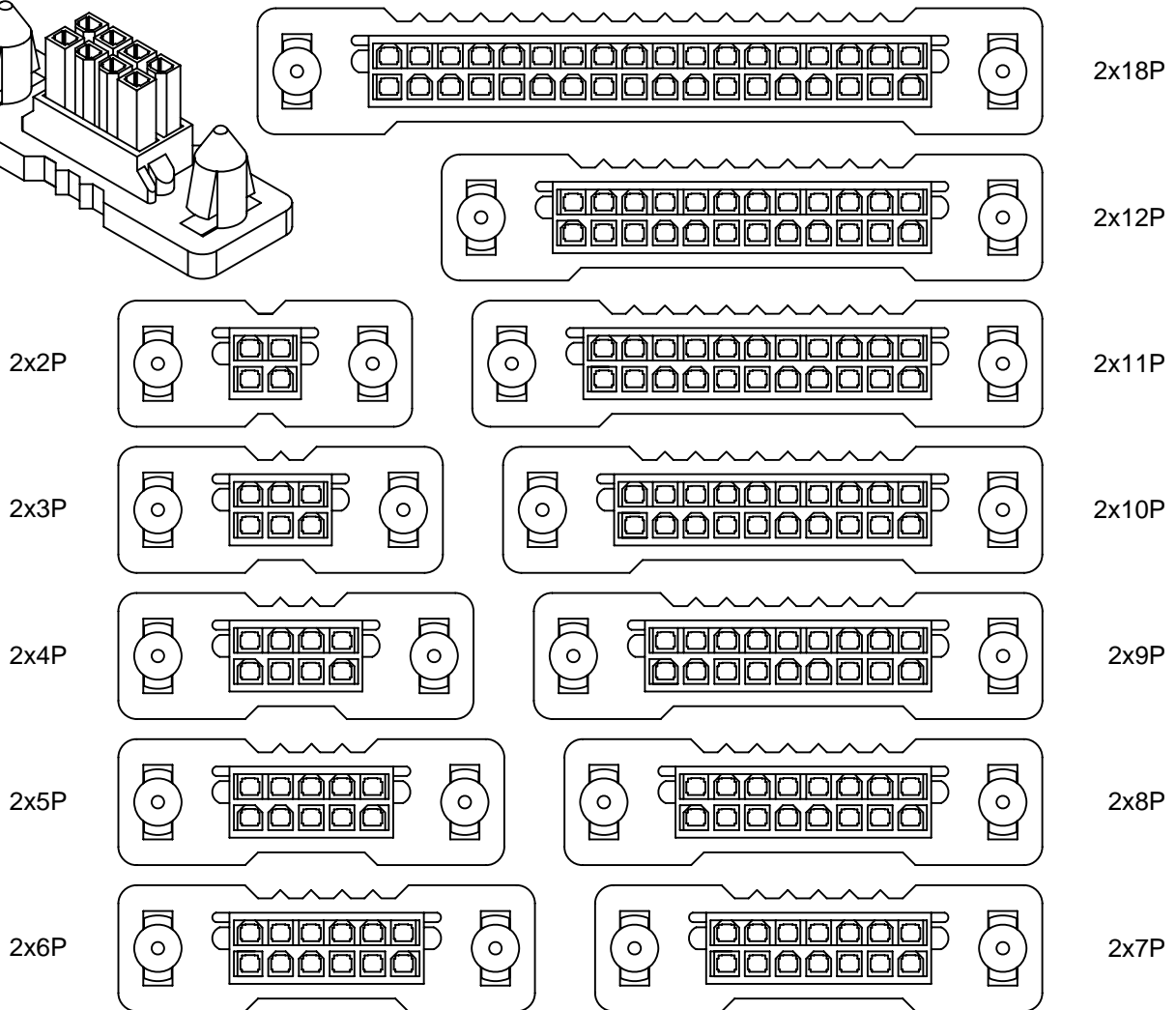

C4201HV-2



C4201HMB-2

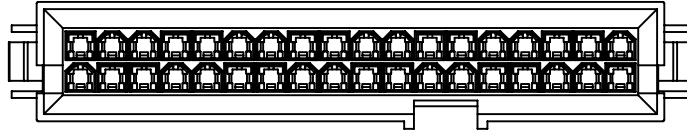
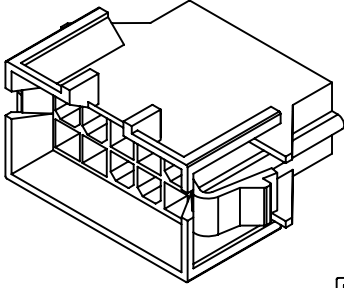

2x18P

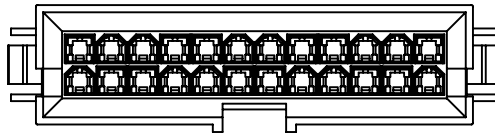

2x12P

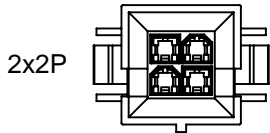

2x2P

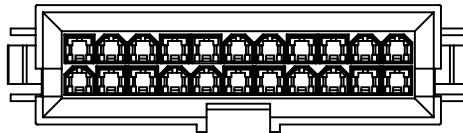

2x11P

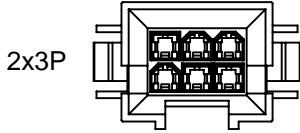

2x3P

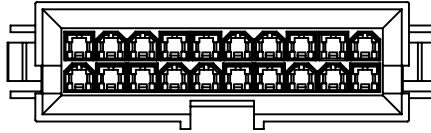

2x10P

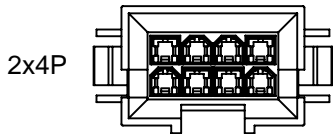

2x4P



2x9P

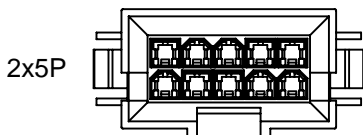

2x5P

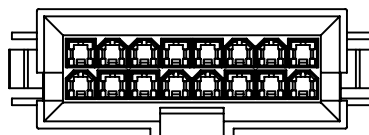

2x8P

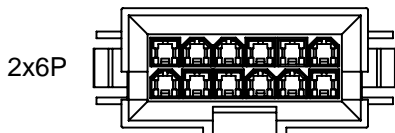

2x6P

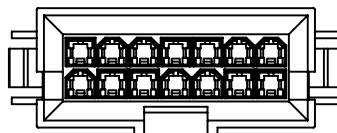

2x7P

C4201WVA-F1-2

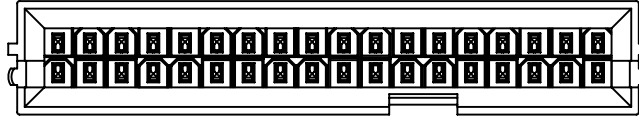
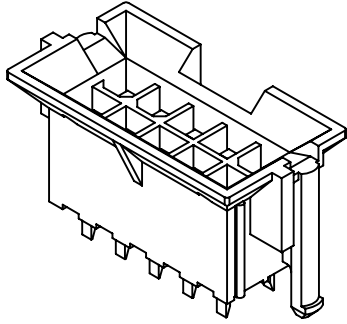

2x18P

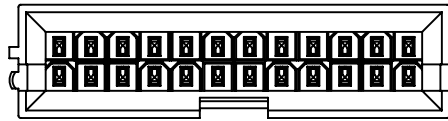

2x12P

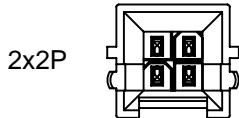

2x2P

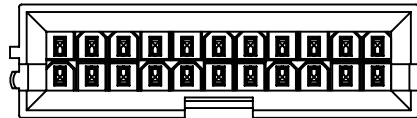

2x11P

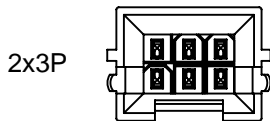

2x3P

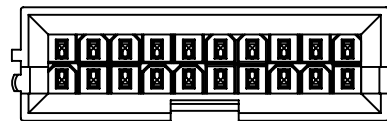

2x10P

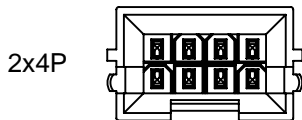

2x4P

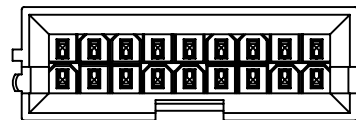

2x9P

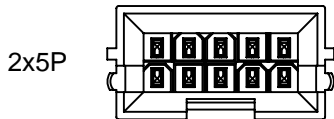

2x5P

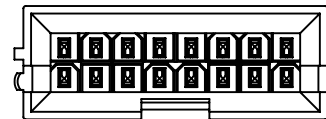

2x8P

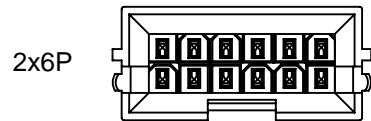

2x6P

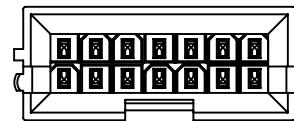

2x7P

C4201WR-F1-2

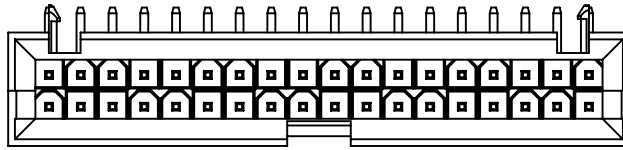
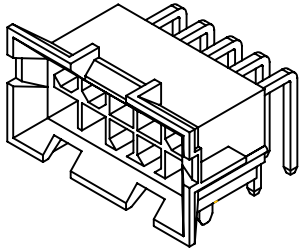

2x18P



2x12P



2x2P



2x11P



2x3P



2x10P



2x4P



2x9P



2x5P



2x8P



2x6P



2x7P

C4201F-T

4.20mm pitch Crimp Terminal

Reference Informations:

*Used in CJT C4201HF series Housing



Ordering information & Specifications:

Unit:mm

Part NO.	Wire Range	Insulation O.D.	Material	Finish	Qty/reel
C4201F-TB	AWG#22-#28	1.80mm(max)	Brass	Tin over Nickel	10,000 PCS
C4201F-TP	AWG#22-#28	1.80mm(max)	Phosphor Bronze	Tin over Nickel	10,000 PCS
C4201F-GB	AWG#22-#28	1.80mm(max)	Brass	Gold over Nickel	10,000 PCS
C4201F-GP	AWG#22-#28	1.80mm(max)	Phosphor Bronze	Gold over Nickel	10,000 PCS

Optional Gold plating available but MOQ requested

C4201M-T

4.20mm pitch Crimp Terminal

Reference Informations:

*Used in CJT C4201HM or C4201HMA series Housing



Ordering information & Specifications:

Unit:mm

Part NO.	Wire Range	Insulation O.D.	Material	Finish	Qty/reel
C4201M-TB	AWG#22-#28	1.80mm(max)	Brass	Tin over Nickel	5,000 PCS
C4201M-TP	AWG#22-#28	1.80mm(max)	Phosphor Bronze	Tin over Nickel	5,000 PCS
C4201M-GB	AWG#22-#28	1.80mm(max)	Brass	Gold over Nickel	5,000 PCS
C4201M-GP	AWG#22-#28	1.80mm(max)	Phosphor Bronze	Gold over Nickel	5,000 PCS

Optional Gold plating available but MOQ requested

C4201F-T-H

4.20mm pitch Crimp Terminal

Reference Informations:

*Used in CJT C4201HF series Housing

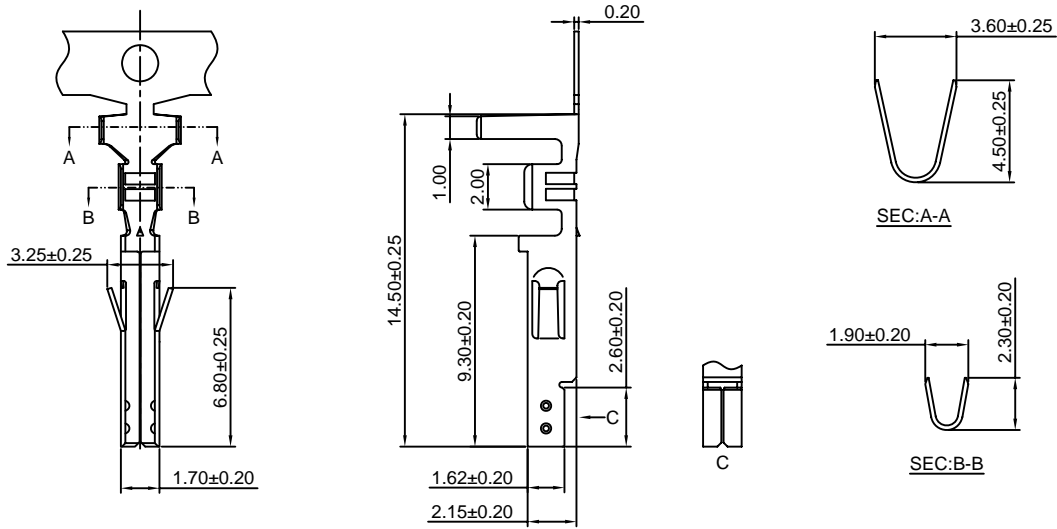

Ordering information & Specifications:

Unit:mm

Part NO.	Wire Range	Insulation O.D.	Material	Finish	Qty/reel
C4201F-TB-H	AWG#18-#24	3.10mm(max)	Brass	Tin over Nickel	4,500 PCS
C4201F-TP-H	AWG#18-#24	3.10mm(max)	Phosphor Bronze	Tin over Nickel	4,500 PCS
C4201F-GB-H	AWG#18-#24	3.10mm(max)	Brass	Gold over Nickel	4,500 PCS
C4201F-GP-H	AWG#18-#24	3.10mm(max)	Phosphor Bronze	Gold over Nickel	4,500 PCS

Optional Gold plating available but MOQ requested

C4201M-T-H

4.20mm pitch Crimp Terminal

Reference Informations:

*Used in CJT C4201HM or C4201HMA series Housing



Ordering information & Specifications:

Unit:mm

Part NO.	Wire Range	Insulation O.D.	Material	Finish	Qty/reel
C4201M-TB-H	AWG#18-#24	3.10mm(max)	Brass	Tin over Nickel	5,000 PCS
C4201M-TP-H	AWG#18-#24	3.10mm(max)	Phosphor Bronze	Tin over Nickel	5,000 PCS
C4201M-GB-H	AWG#18-#24	3.10mm(max)	Brass	Gold over Nickel	5,000 PCS
C4201M-GP-H	AWG#18-#24	3.10mm(max)	Phosphor Bronze	Gold over Nickel	5,000 PCS

Optional Gold plating available but MOQ requested

C4201F-T-HH

4.20mm pitch Crimp Terminal

Reference Informations:

*Used in CJT C4201HF series Housing

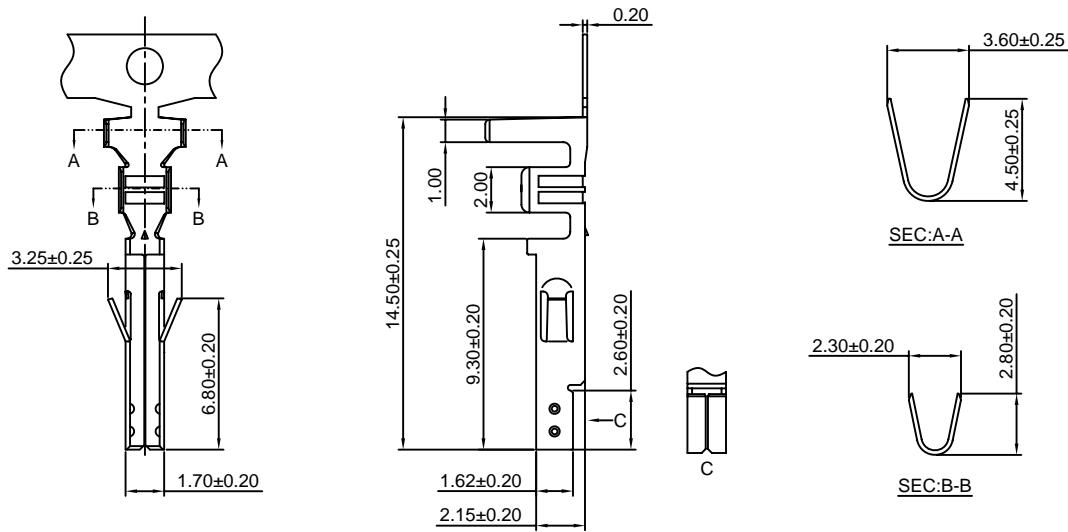

Ordering information & Specifications:

Unit:mm

Part NO.	Wire Range	Insulation O.D.	Material	Finish	Qty/reel
C4201F-TB-HH	AWG#16	4.30mm(max)	Brass	Tin over Nickel	4,500 PCS
C4201F-TP-HH	AWG#16	4.30mm(max)	Phosphor Bronze	Tin over Nickel	4,500 PCS
C4201F-GB-HH	AWG#16	4.30mm(max)	Brass	Gold over Nickel	4,500 PCS
C4201F-GP-HH	AWG#16	4.30mm(max)	Phosphor Bronze	Gold over Nickel	4,500 PCS

Optional Gold plating available but MOQ requested

C4201M-T-HH

4.20mm pitch Crimp Terminal

Reference Informations:

*Used in CJT C4201HM or C4201HMA series Housing

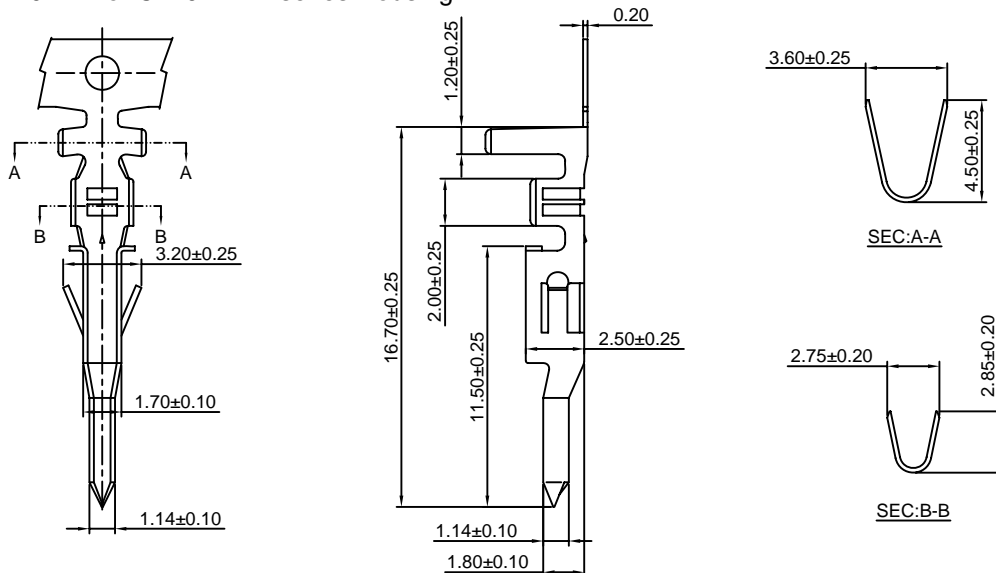

Ordering information & Specifications:

Unit:mm

Part NO.	Wire Range	Insulation O.D.	Material	Finish	Qty/reel
C4201M-TB-HH	AWG#16	4.30mm(max)	Brass	Tin over Nickel	4,000 PCS
C4201M-TP-HH	AWG#16	4.30mm(max)	Phosphor Bronze	Tin over Nickel	4,000 PCS
C4201M-GB-HH	AWG#16	4.30mm(max)	Brass	Gold over Nickel	4,000 PCS
C4201M-GP-HH	AWG#16	4.30mm(max)	Phosphor Bronze	Gold over Nickel	4,000 PCS

Optional Gold plating available but MOQ requested

C4201HF

4.20mm Pitch Single Row Housing

Reference Informations:

- *Material:Nylon 66,UL94V-2 or UL94V-0
- *Suitable CJT C4201F series Terminal
- *Mates with CJT C4201HM,C4201HMA series single row Housing or C4201 series single row Wafer
- *Color:Natural

Ordering Information:

- C4201HF-XP - **
 1 2
 1.Part No.
 2.Material:
 (blank):UL94V-2 /Natural
 V0:UL94V-0/White

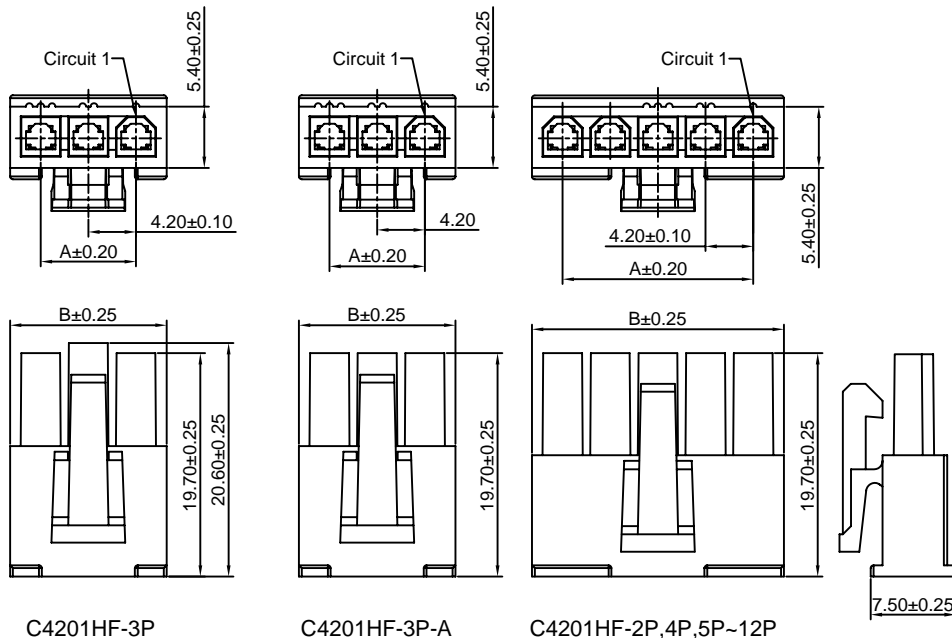
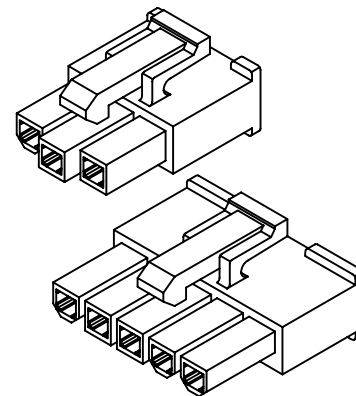

Ordering Information & Dimensions:

PART NO.	Dimensions	
	A	B
C4201HF-2P	4.20	9.60
C4201HF-3P	8.40	13.80
C4201HF-4P	12.60	18.00
C4201HF-5P	16.80	22.20
C4201HF-6P	21.00	26.40
C4201HF-7P	25.20	30.60
C4201HF-8P	29.40	34.80
C4201HF-9P	33.60	39.00
C4201HF-10P	37.80	43.20
C4201HF-11P	42.00	47.40
C4201HF-12P	46.20	51.60

Unit: mm

C4201HM

4.20mm Pitch Single Row Housing

Reference Informations:

- *Material:Nylon 66,UL94V-2 or UL94V-0
- *Suitable CJT C4201M series Terminal
- *Mates with CJT C4201HF series single row Housing
- *Color:Natural

Ordering Information:

- C4201HM-XP - **
 1 2
 1.Part No.
 2.Material:
 (blank):UL94V-2 /Natural
 V0:UL94V-0/White

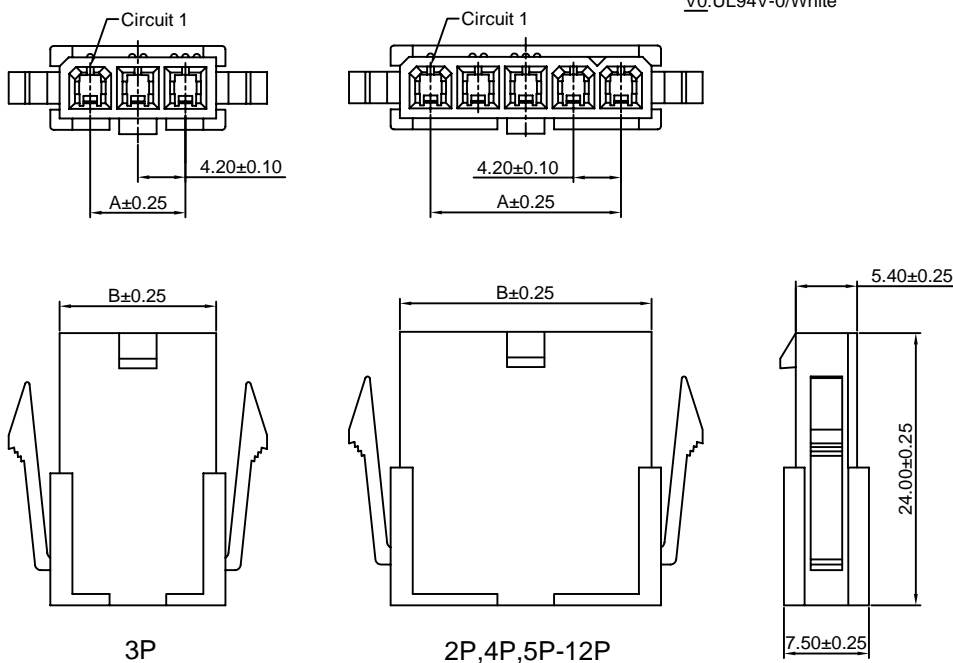
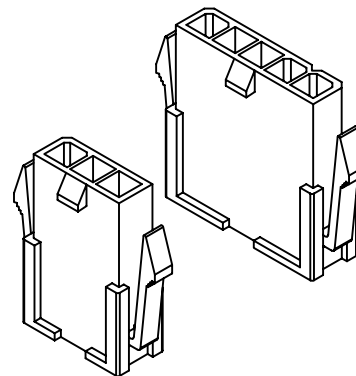

Ordering Information & Dimensions:

PART NO.	Dimensions	
	A	B
C4201HM-2P	4.20	9.60
C4201HM-3P	8.40	13.80
C4201HM-4P	12.60	18.00
C4201HM-5P	16.80	22.20
C4201HM-6P	21.00	26.40
C4201HM-7P	25.20	30.60
C4201HM-8P	29.40	34.80
C4201HM-9P	33.60	39.00
C4201HM-10P	37.80	43.20
C4201HM-11P	42.00	47.40
C4201HM-12P	46.20	51.60

Unit: mm

C4201HMA

4.20mm Pitch Single Row Housing - Without Mounting Ears

Reference Informations:

- *Material: Nylon 66, UL94V-2 or UL94V-0
- *Suitable CJT C4201M series Terminal
- *Mates with CJT C4201HF series single row Housing
- *Color: Natural

Ordering Information:

- C4201HMA-XP - **
- | | |
|---|---|
| 1 | 2 |
|---|---|
- Part No.
 - Material:
(blank): UL94V-2 / Natural
V0: UL94V-0 / White

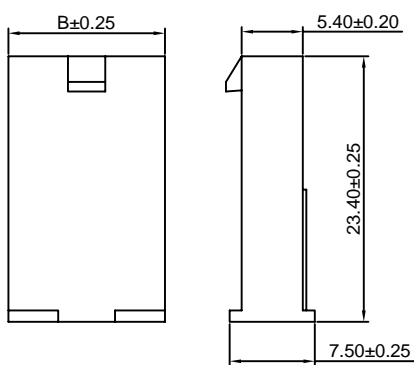
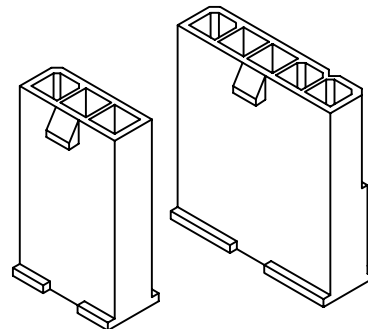
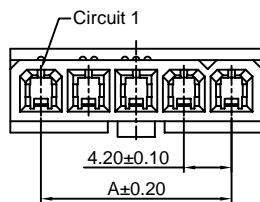
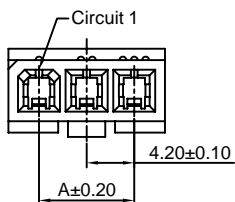

3P

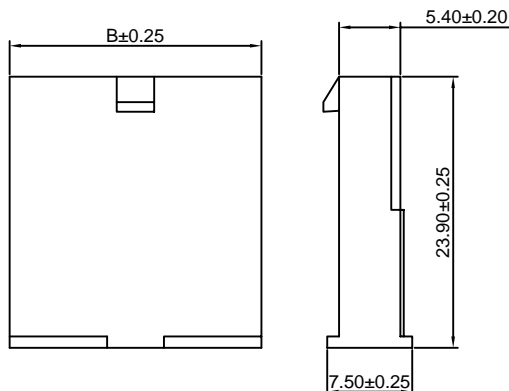

2P, 4P, 5P-12P

Ordering Information & Dimensions:

PART NO.	Dimensions	
	A	B
C4201HMA-2P	4.20	9.60
C4201HMA-3P	8.40	13.80
C4201HMA-4P	12.60	18.00
C4201HMA-5P	16.80	22.20
C4201HMA-6P	21.00	26.40
C4201HMA-7P	25.20	30.60
C4201HMA-8P	29.40	34.80
C4201HMA-9P	33.60	39.00
C4201HMA-10P	37.80	43.20
C4201HMA-11P	42.00	47.40
C4201HMA-12P	46.20	51.60

Unit: mm

C4201HF-2

4.20mm pitch Dual Row Housing

Reference Informations:

- *Material: Nylon 66, UL94V-2 or UL94V-0
- *Suitable CJT C4201F series Terminal
- *Mates with CJT C4201HM, C4201HMA series dual row Housing or C4201 series dual row Wafer
- *Color: Natural

Ordering Information:

- C4201HF-2xXP - **
- | | |
|---|---|
| 1 | 2 |
|---|---|
- Part No.
 - Material:
(blank): UL94V-2 / Natural
V0: UL94V-0 / White

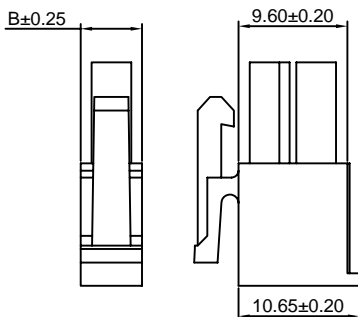
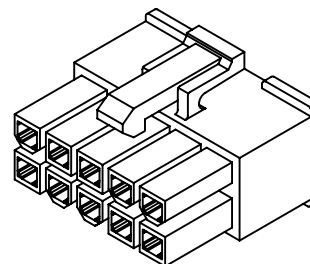
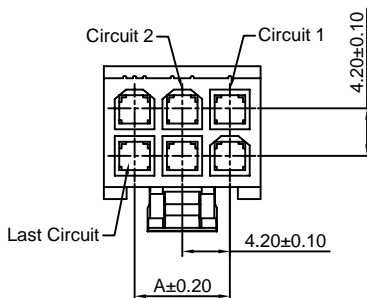
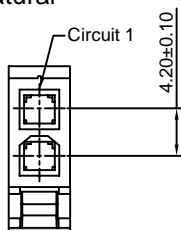

2x1P

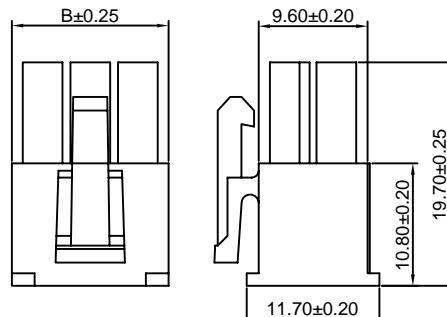

2x2P~2x12P

Ordering Information & Dimensions:

PART NO.	Dimensions	
	A	B
C4201HF-2x1P	-----	5.40
C4201HF-2x2P	4.20	9.60
C4201HF-2x3P	8.40	13.80
C4201HF-2x4P	12.60	18.00
C4201HF-2x5P	16.80	22.20
C4201HF-2x6P	21.00	26.40
C4201HF-2x7P	25.20	30.60
C4201HF-2x8P	29.40	34.80
C4201HF-2x9P	33.60	39.00
C4201HF-2x10P	37.80	43.20
C4201HF-2x11P	42.00	47.40
C4201HF-2x12P	46.20	51.60

Unit: mm

C4201HM-2

4.20mm pitch Dual Row Housing

Reference Informations:

- *Material: Nylon 66, UL94V-2 or UL94V-0
- *Suitable CJT C4201M series Terminal
- *Mates with CJT C4201HF series dual row Housing
- *Color: Natural

Ordering Information:

- C4201HM-2xXP - **
 $\frac{1}{2}$
1. Part No.
 2. Material:
 (blank): UL94V-2 / Natural
 V0: UL94V-0 / White

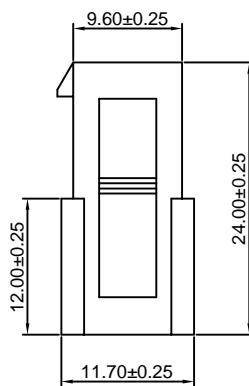
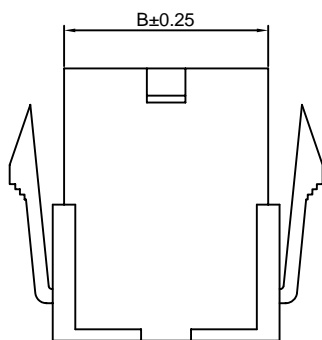
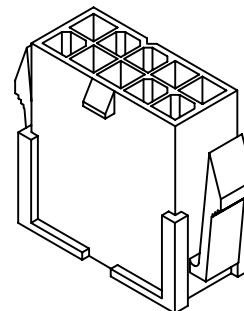
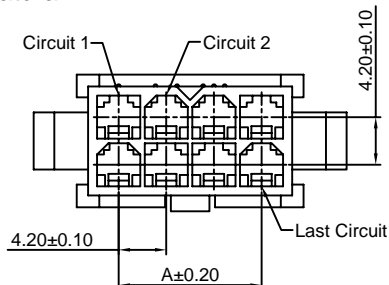

Ordering Information & Dimensions:

PART NO.	Dimensions	
	A	B
C4201HM-2x1P	-----	5.40
C4201HM-2x2P	4.20	9.60
C4201HM-2x3P	8.40	13.80
C4201HM-2x4P	12.60	18.00
C4201HM-2x5P	16.80	22.20
C4201HM-2x6P	21.00	26.40
C4201HM-2x7P	25.20	30.60
C4201HM-2x8P	29.40	34.80
C4201HM-2x9P	33.60	39.00
C4201HM-2x10P	37.80	43.20
C4201HM-2x11P	42.00	47.40
C4201HM-2x12P	46.20	51.60

Unit: mm

C4201HM-2-A

4.20mm pitch Dual Row Housing

Reference Informations:

- *Material: Nylon 66, UL94V-2 or UL94V-0
- *Suitable CJT C4201M series Terminal
- *Mates with CJT C4201HF series dual row Housing
- *Color: Natural

Ordering Information:

- C4201HM-2xXP - **
 $\frac{1}{2}$
1. Part No.
 2. Material:
 (blank): UL94V-2 / Natural
 V0: UL94V-0 / White

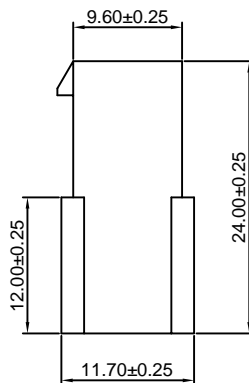
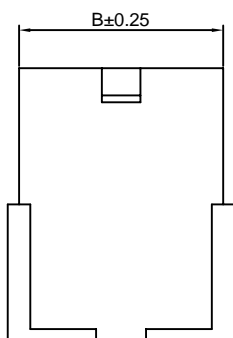
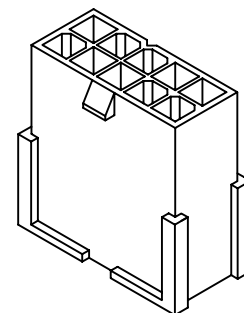
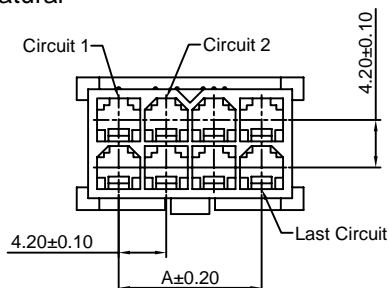

Ordering Information & Dimensions:

PART NO.	Dimensions	
	A	B
C4201HM-2x1P-A	-----	5.40
C4201HM-2x2P-A	4.20	9.60
C4201HM-2x3P-A	8.40	13.80
C4201HM-2x4P-A	12.60	18.00
C4201HM-2x5P-A	16.80	22.20
C4201HM-2x6P-A	21.00	26.40
C4201HM-2x7P-A	25.20	30.60
C4201HM-2x8P-A	29.40	34.80
C4201HM-2x9P-A	33.60	39.00
C4201HM-2x10P-A	37.80	43.20
C4201HM-2x11P-A	42.00	47.40
C4201HM-2x12P-A	46.20	51.60

Unit: mm

C4201HMA-2

4.20mm pitch Dual Row Housing - Without Mounting Ears

Reference Informations:

- *Material:Nylon 66,UL94V-2 or UL94V-0
- *Suitable CJT C4201M series Terminal
- *Mates with CJT C4201HM series dual row Housing
- *Color:Natural

Ordering Information:C4201HMA-2xXP - **

- 1.Part No.
- 2.Material:
(blank):UL94V-2 /Natural
V0:UL94V-0/White

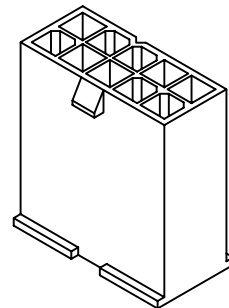
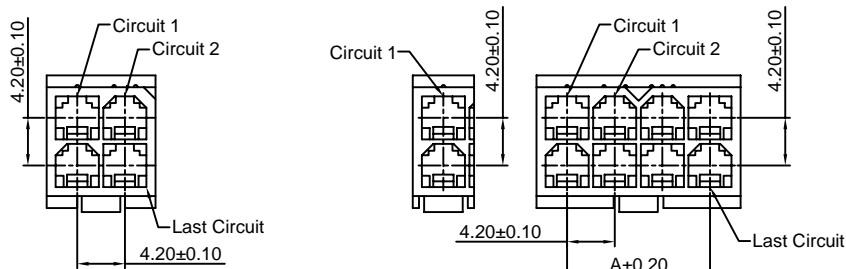
**Ordering Information & Dimensions:**

PART NO.	Dimensions	
	A	B
C4201HMA-2x1P	-----	5.40
C4201HMA-2x2P	4.20	9.60
C4201HMA-2x3P	8.40	13.80
C4201HMA-2x4P	12.60	18.00
C4201HMA-2x5P	16.80	22.20
C4201HMA-2x6P	21.00	26.40
C4201HMA-2x7P	25.20	30.60
C4201HMA-2x8P	29.40	34.80
C4201HMA-2x9P	33.60	39.00
C4201HMA-2x10P	37.80	43.20
C4201HMA-2x11P	42.00	47.40
C4201HMA-2x12P	46.20	51.60

Unit: mm

C4201WV

4.20mm pitch 180° Single Row Wafer

Reference Informations:

- *Material:Pin:Brass/Tin over Nickel
Insulator:Nylon 66,UL94V-2 or UL94V-0
- *Mates with CJT C4201 series single row Housing
- *Color:Natural

Ordering Information:C4201WV-XP - **

- 1.Part No.
- 2.Material:
(blank):UL94V-2 /Natural
V0:UL94V-0/White

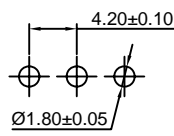
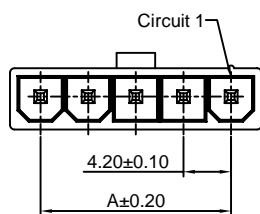
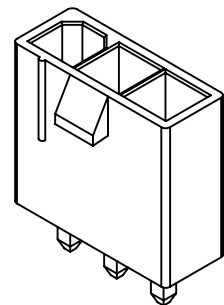
P.C.B LAYOUT**Ordering Information & Dimensions:**

PART NO.	Dimensions	
	A	B
C4201WV-2P	4.20	9.60
C4201WV-3P	8.40	13.80
C4201WV-4P	12.60	18.00
C4201WV-5P	16.80	22.20
C4201WV-6P	21.00	26.40
C4201WV-7P	25.20	30.60
C4201WV-8P	29.40	34.80
C4201WV-9P	33.60	39.00
C4201WV-10P	37.80	43.20
C4201WV-11P	42.00	47.40
C4201WV-12P	46.20	51.60

Unit: mm

C4201WVA

4.20mm pitch 180° Single Row Wafer With Pegs

Reference Informations:

- *Material: Pin: Brass/Tin over Nickel
Insulator: Nylon 66, UL94V-2 or UL94V-0
- *Mates with CJT C4201HF series single row Housing
- *Color: Natural

Ordering Information:
C4201WVA-F-XP - **
1 2

- 1. Part No.
- 2. Material:
(blank): UL94V-2 / Natural
V0: UL94V-0 / White

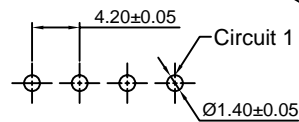
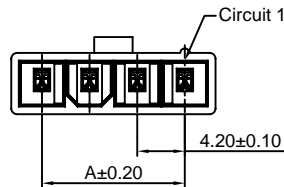
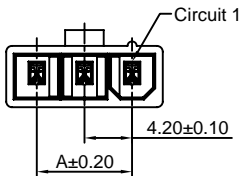
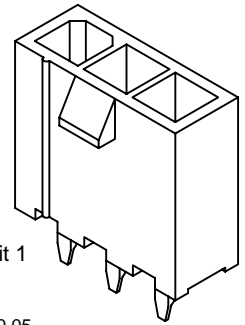

P.C.B LAYOUT

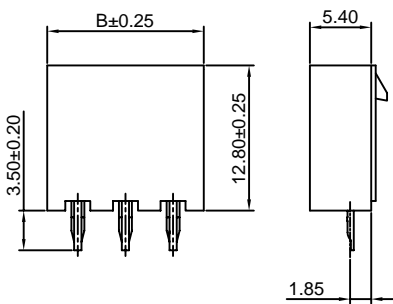

3P

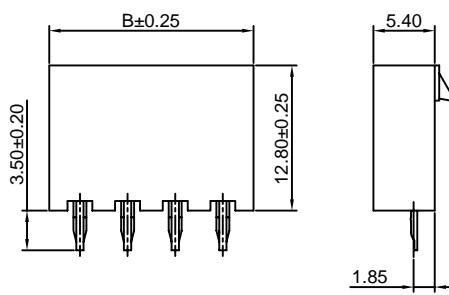

2P, 4P~12P

Ordering Information & Dimensions:

PART NO.	Dimensions	
	A	B
C4201WVA-2P	4.20	9.60
C4201WVA-3P	8.40	13.80
C4201WVA-4P	12.60	18.00
C4201WVA-5P	16.80	22.20
C4201WVA-6P	21.00	26.40
C4201WVA-7P	25.20	30.60
C4201WVA-8P	29.40	34.80
C4201WVA-9P	33.60	39.00
C4201WVA-10P	37.80	43.20
C4201WVA-11P	42.00	47.40
C4201WVA-12P	46.20	51.60

Unit: mm

C4201WVA-F

4.20mm pitch 180° Single Row Wafer With Pegs

Reference Informations:

- *Material: Pin: Brass/Tin over Nickel
Insulator: Nylon 66, UL94V-2 or UL94V-0
- *Mates with CJT C4201HF series single row Housing
- *Color: Natural

Ordering Information:
C4201WVA-F-XP - **
1 2

- 1. Part No.
- 2. Material:
(blank): UL94V-2 / Natural
V0: UL94V-0 / White

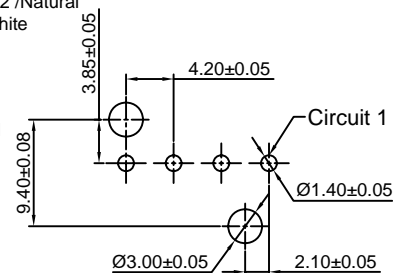
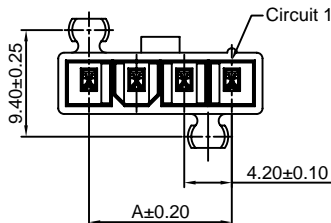
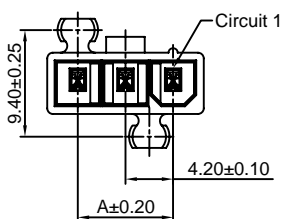
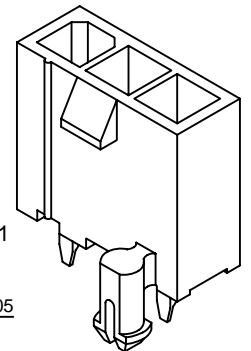

P.C.B LAYOUT

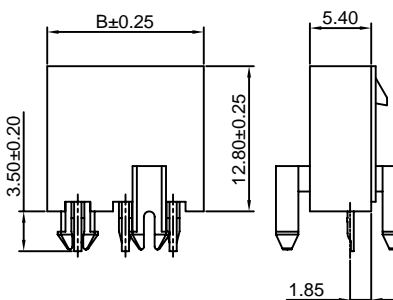

3P

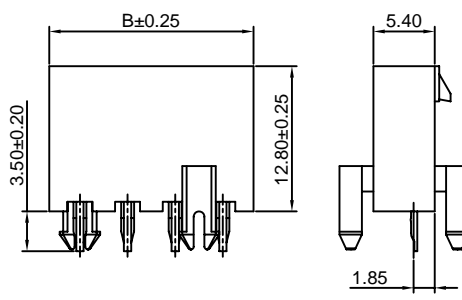

2P, 4P~12P

Ordering Information & Dimensions:

PART NO.	Dimensions	
	A	B
C4201WVA-F-2P	4.20	9.60
C4201WVA-F-3P	8.40	13.80
C4201WVA-F-4P	12.60	18.00
C4201WVA-F-5P	16.80	22.20
C4201WVA-F-6P	21.00	26.40
C4201WVA-F-7P	25.20	30.60
C4201WVA-F-8P	29.40	34.80
C4201WVA-F-9P	33.60	39.00
C4201WVA-F-10P	37.80	43.20
C4201WVA-F-11P	42.00	47.40
C4201WVA-F-12P	46.20	51.60

Unit: mm

C4201WR

4.20mm pitch 90° Single Row Wafer

Reference Informations:

- *Material:Pin:Brass/Tin over Nickel
Insulator:Nylon 66,UL94V-2 or UL94V-0
- *Mates with CJT C4201HF series single row Housing
- *Color:Natural

Ordering Information:

- C4201WR-XP - **
 $\frac{1}{2}$
- 1.Part No.
 - 2.Material:
(blank):UL94V-2 /Natural
V0:UL94V-0/White

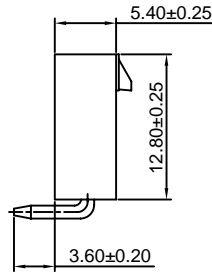
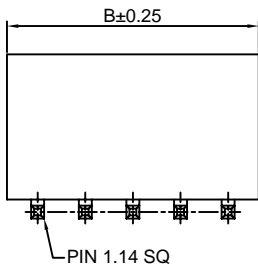
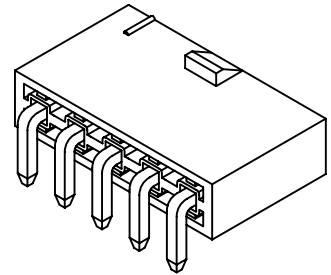
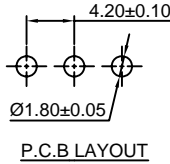
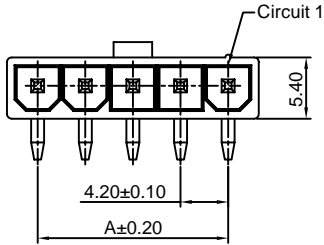

Ordering Information & Dimensions:

PART NO.	Dimensions	
	A	B
C4201WR-2P	4.20	9.60
C4201WR-3P	8.40	13.80
C4201WR-4P	12.60	18.00
C4201WR-5P	16.80	22.20
C4201WR-6P	21.00	26.40
C4201WR-7P	25.20	30.60
C4201WR-8P	29.40	34.80
C4201WR-9P	33.60	39.00
C4201WR-10P	37.80	43.20
C4201WR-11P	42.00	47.40
C4201WR-12P	46.20	51.60

Unit: mm

C4201WR-E

4.20mm pitch 90° Single Row Wafer With Ear

Reference Informations:

- *Material:Pin:Brass/Tin over Nickel
Insulator:Nylon 66,UL94V-2 or UL94V-0
- *Mates with CJT C4201HF series single row Housing
- *Color:Natural

Ordering Information:

- C4201WR-E-XP - **
 $\frac{1}{2}$
- 1.Part No.
 - 2.Material:
(blank):UL94V-2 /Natural
V0:UL94V-0/White

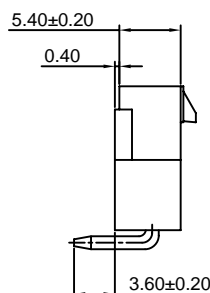
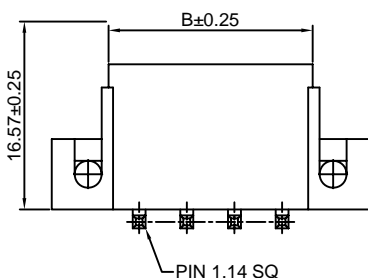
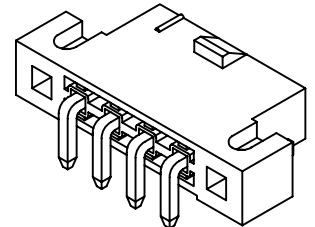
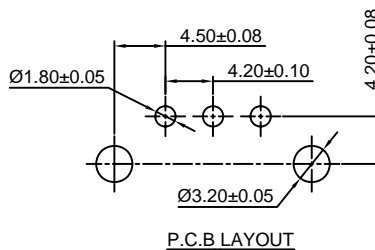
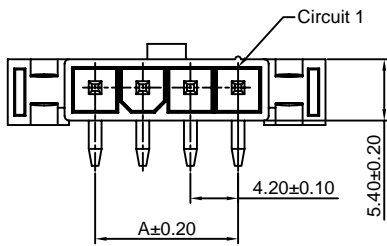

Ordering Information & Dimensions:

PART NO.	Dimensions	
	A	B
C4201WR-E-2P	4.20	9.60
C4201WR-E-3P	8.40	13.80
C4201WR-E-4P	12.60	18.00
C4201WR-E-5P	16.80	22.20
C4201WR-E-6P	21.00	26.40
C4201WR-E-7P	25.20	30.60
C4201WR-E-8P	29.40	34.80
C4201WR-E-9P	33.60	39.00
C4201WR-E-10P	37.80	43.20
C4201WR-E-11P	42.00	47.40
C4201WR-E-12P	46.20	51.60

Unit: mm

C4201WR-F

4.20mm pitch 90° Single Row Wafer With Pegs

Reference Informations:

- *Material: Pin: Brass/Tin over Nickel
Insulator: Nylon 66, UL94V-2 or UL94V-0
- *Mates with CJT C4201HF series single row Housing
- *Color: Natural

Ordering Information:
C4201WR-F-XP - **

1. Part No.
2. Material:
(blank): UL94V-2 / Natural
V0: UL94V-0 / White

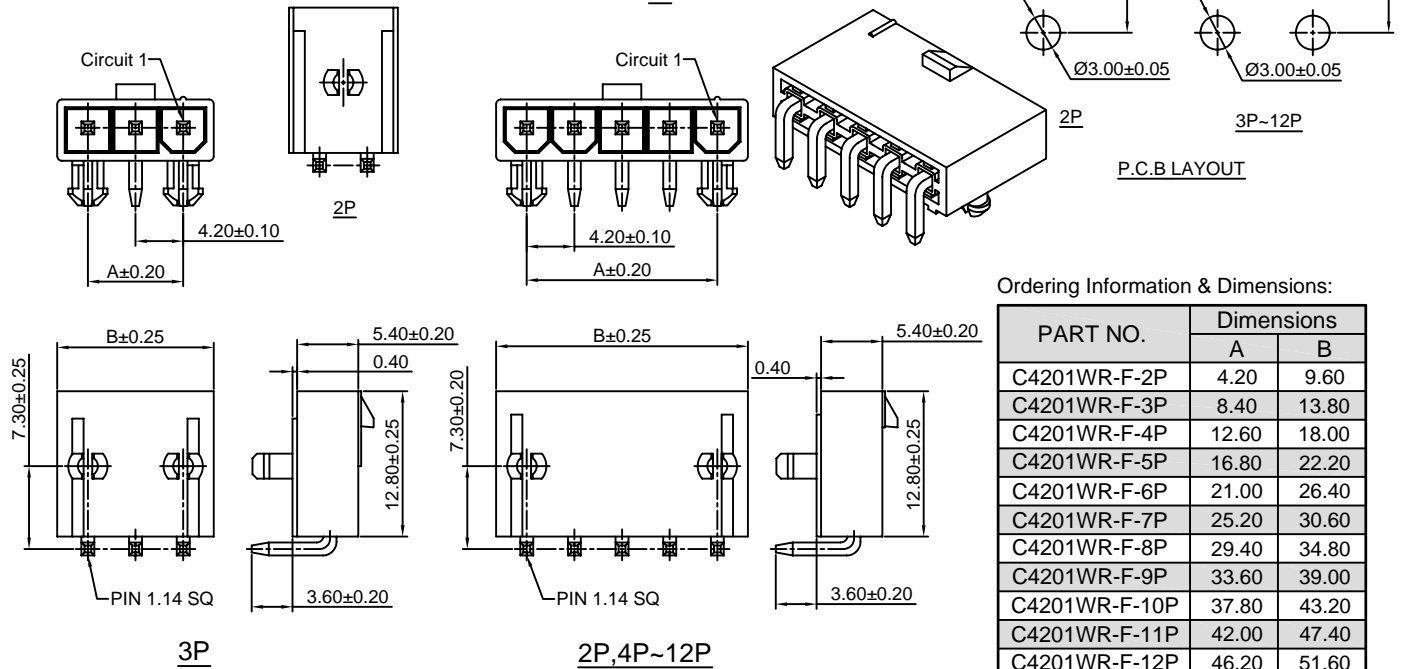

C4201WV-2

4.20mm pitch 180° Dual Row Wafer

Reference Informations:

- *Material: Pin: Brass/Tin over Nickel
Insulator: Nylon 66, UL94V-2 or UL94V-0
- *Mates with CJT C4201HF series dual row Housing
- *Color: Natural

Ordering Information:
C4201WV-2xXP - **

1. Part No.
2. Material:
(blank): UL94V-2 / Natural
V0: UL94V-0 / White

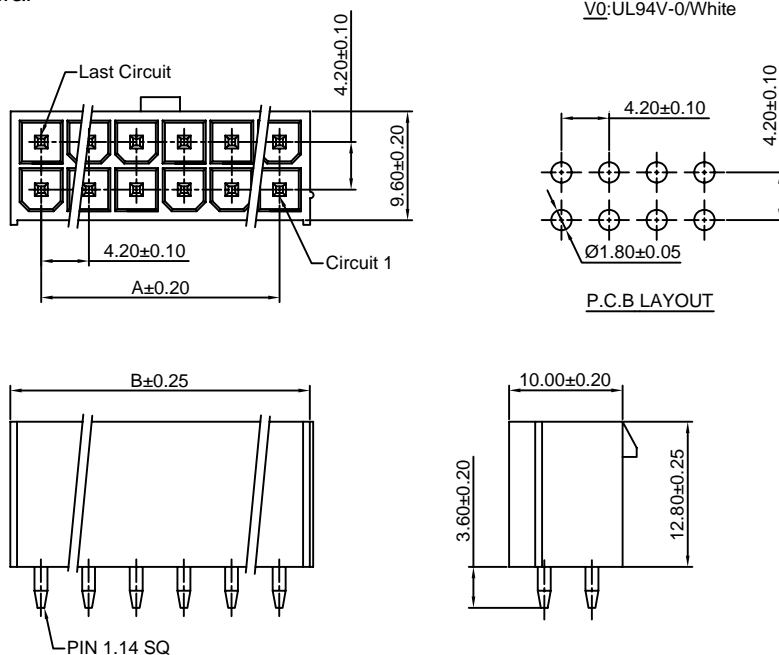

C4201WVA-2

4.20mm pitch 180° Dual Row Wafer

Reference Informations:

- *Material: Pin: Brass/Tin over Nickel
Insulator: Nylon 66, UL94V-2 or UL94V-0
- *Mates with CJT C4201HF series dual row Housing
- *Color: Natural

Ordering Information:

- C4201WVA-2xXP - **
- | | |
|---|---|
| 1 | 2 |
|---|---|
1. Part No.
 2. Material:
(blank): UL94V-2/Natural
V0: UL94V-0/White

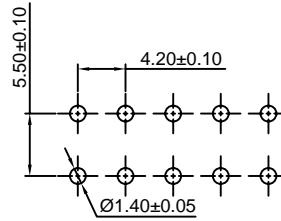
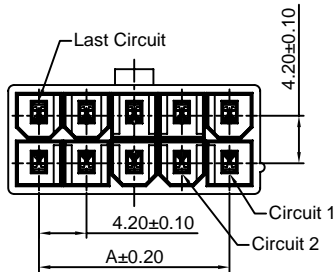

P.C.B LAYOUT

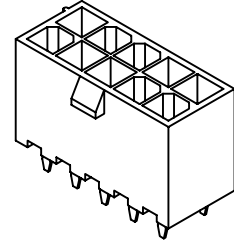

Ordering Information & Dimensions:

PART NO.	Dimensions	
	A	B
C4201WVA-2x1P	-----	5.40
C4201WVA-2x2P	4.20	9.60
C4201WVA-2x3P	8.40	13.80
C4201WVA-2x4P	12.60	18.00
C4201WVA-2x5P	16.80	22.20
C4201WVA-2x6P	21.00	26.40
C4201WVA-2x7P	25.20	30.60
C4201WVA-2x8P	29.40	34.80
C4201WVA-2x9P	33.60	39.00
C4201WVA-2x10P	37.80	43.20
C4201WVA-2x11P	42.00	47.40
C4201WVA-2x12P	46.20	51.60

Unit: mm

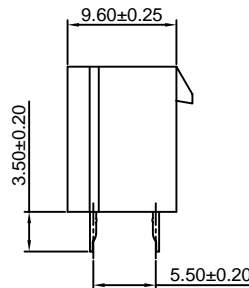
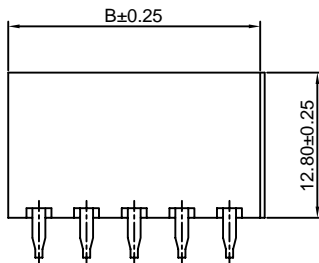

C4201WVA-F-2

4.20mm pitch 180° Dual Row Wafer With Foot

Reference Informations:

- *Material: Pin: Brass/Tin over Nickel
Insulator: Nylon 66, UL94V-2 or UL94V-0
- *Mates with CJT C4201HF series dual row Housing
- *Color: Natural

Ordering Information:

- C4201WVA-F-2xXP - **
- | | |
|---|---|
| 1 | 2 |
|---|---|
1. Part No.
 2. Material:
(blank): UL94V-2/Natural
V0: UL94V-0/White

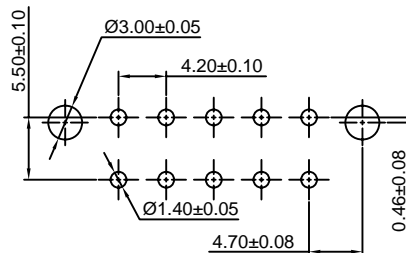

P.C.B LAYOUT

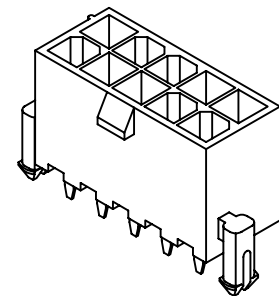

Ordering Information & Dimensions:

PART NO.	Dimensions	
	A	B
C4201WVA-F-2x1P	-----	5.40
C4201WVA-F-2x2P	4.20	9.60
C4201WVA-F-2x3P	8.40	13.80
C4201WVA-F-2x4P	12.60	18.00
C4201WVA-F-2x5P	16.80	22.20
C4201WVA-F-2x6P	21.00	26.40
C4201WVA-F-2x7P	25.20	30.60
C4201WVA-F-2x8P	29.40	34.80
C4201WVA-F-2x9P	33.60	39.00
C4201WVA-F-2x10P	37.80	43.20
C4201WVA-F-2x11P	42.00	47.40
C4201WVA-F-2x12P	46.20	51.60

Unit: mm

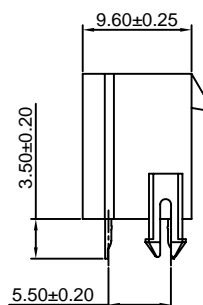
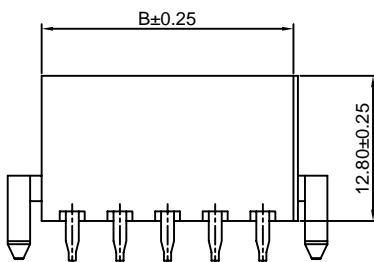

C4201WR-2

4.20mm pitch 90° Dual Row Wafer

Reference Informations:

- *Material: Pin: Brass/Tin over Nickel
Insulator: Nylon 66, UL94V-2 or UL94V-0
- *Mates with CJT C4201HF series dual row Housing
- *Color: Natural

Ordering Information:

- C4201WR-2xXP - **
- | | |
|---|---|
| 1 | 2 |
|---|---|
- Part No.
 - Material:
(blank): UL94V-2/Natural
V0: UL94V-0/White

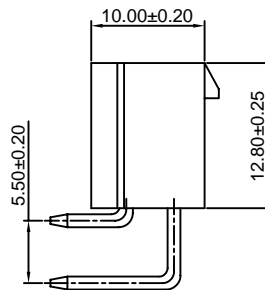
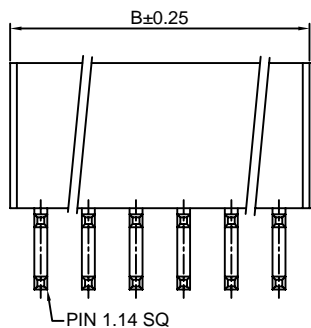
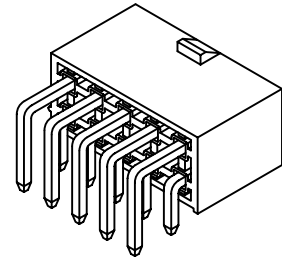
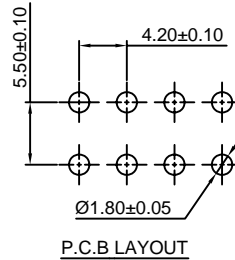
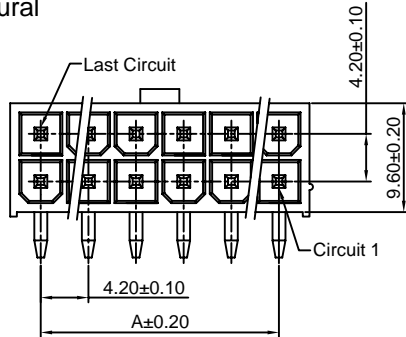

Ordering Information & Dimensions:

PART NO.	Dimensions	
	A	B
C4201WR-2x1P	-----	5.40
C4201WR-2x2P	4.20	9.60
C4201WR-2x3P	8.40	13.80
C4201WR-2x4P	12.60	18.00
C4201WR-2x5P	16.80	22.20
C4201WR-2x6P	21.00	26.40
C4201WR-2x7P	25.20	30.60
C4201WR-2x8P	29.40	34.80
C4201WR-2x9P	33.60	39.00
C4201WR-2x10P	37.80	43.20
C4201WR-2x11P	42.00	47.40
C4201WR-2x12P	46.20	51.60

Unit: mm

C4201WR-E-2

4.20mm pitch 180° Dual Row Wafer With Ear

Reference Informations:

- *Material: Pin: Brass/Tin over Nickel
Insulator: Nylon 66, UL94V-2 or UL94V-0
- *Mates with CJT C4201HF series dual row Housing
- *Color: Natural

Ordering Information:

- C4201WR-E-2xXP - **
- | | |
|---|---|
| 1 | 2 |
|---|---|
- Part No.
 - Material:
(blank): UL94V-2/Natural
V0: UL94V-0/White

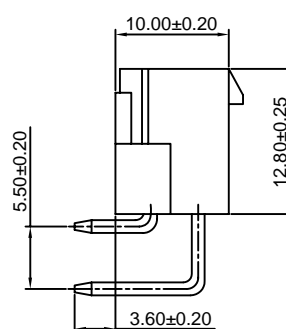
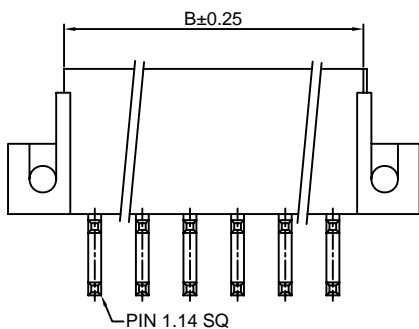
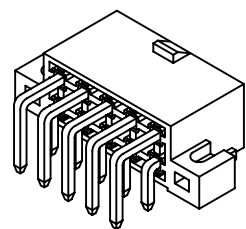
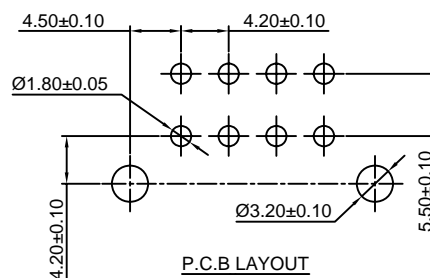
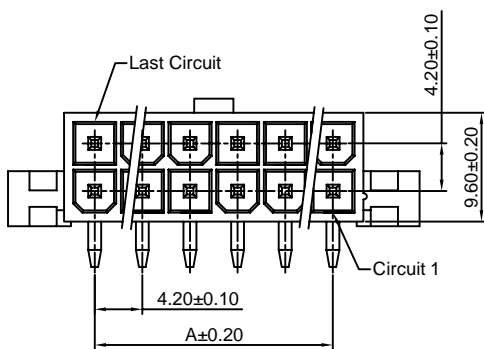

Ordering Information & Dimensions:

PART NO.	Dimensions	
	A	B
C4201WR-E-2x1P	-----	5.40
C4201WR-E-2x2P	4.20	9.60
C4201WR-E-2x3P	8.40	13.80
C4201WR-E-2x4P	12.60	18.00
C4201WR-E-2x5P	16.80	22.20
C4201WR-E-2x6P	21.00	26.40
C4201WR-E-2x7P	25.20	30.60
C4201WR-E-2x8P	29.40	34.80
C4201WR-E-2x9P	33.60	39.00
C4201WR-E-2x10P	37.80	43.20
C4201WR-E-2x11P	42.00	47.40
C4201WR-E-2x12P	46.20	51.60

Unit: mm

C4201WR-F-2

4.20mm pitch 90° Dual Row Wafer With Foot

Reference Informations:

- *Material: Pin: Brass/Tin over Nickel
Insulator: Nylon 66, UL94V-2 or UL94V-0
- *Mates with CJT C4201HF series dual row Housing
- *Color: Natural

Ordering Information:
C4201WR-F-2xXP - **
1 2

1. Part No.
2. Material:
(blank): UL94V-2/Natural
V0: UL94V-0/White

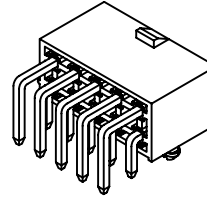
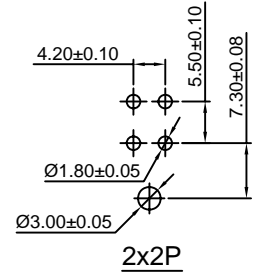
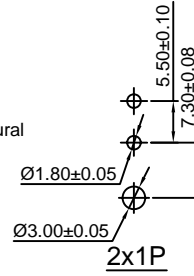
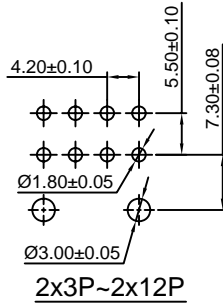
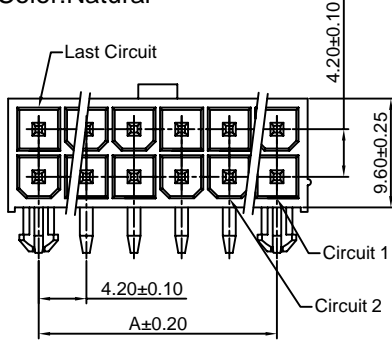

Ordering Information & Dimensions:

PART NO.	Dimensions	
	A	B
C4201WR-F-2x1P	-----	5.40
C4201WR-F-2x2P	4.20	9.60
C4201WR-F-2x3P	8.40	13.80
C4201WR-F-2x4P	12.60	18.00
C4201WR-F-2x5P	16.80	22.20
C4201WR-F-2x6P	21.00	26.40
C4201WR-F-2x7P	25.20	30.60
C4201WR-F-2x8P	29.40	34.80
C4201WR-F-2x9P	33.60	39.00
C4201WR-F-2x10P	37.80	43.20
C4201WR-F-2x11P	42.00	47.40
C4201WR-F-2x12P	46.20	51.60

Unit: mm

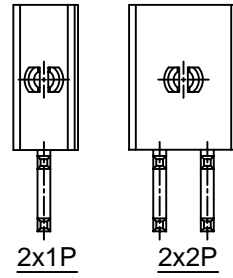
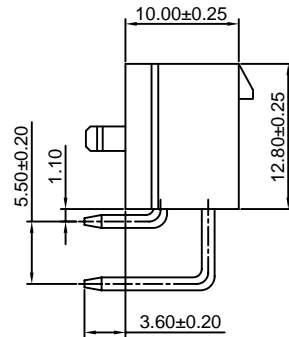
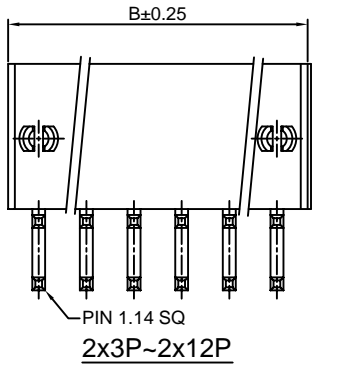

C4201HF-2x3P-A/B

4.20mm pitch Dual Row Housing - Special Type

Reference Informations:

- *Material: Nylon 66, UL94V-2 or UL94V-0
- *Suitable CJT C4201F series Terminal
- *Mates with CJT C4201HM or C4201WV special type series dual row Housing or Wafer
- *Color: Black

Ordering Information:
C4201HF-2x3P - **
1 2

1. Part No.
2. Material:
(blank): UL94V-2/Black
V0: UL94V-0/Black

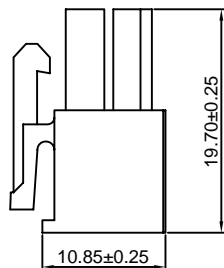
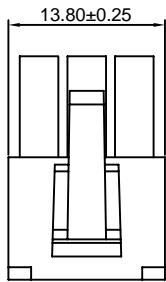
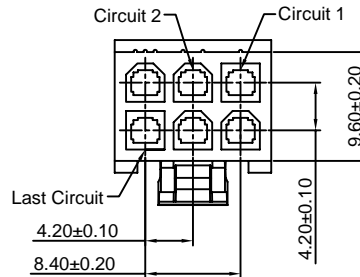
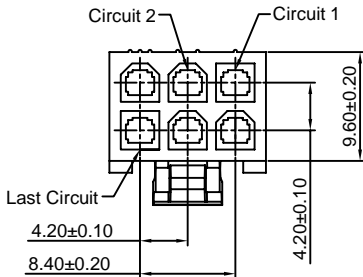
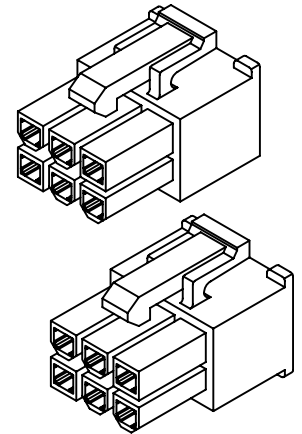

C4201HF-2x3P-A

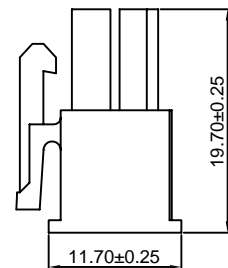
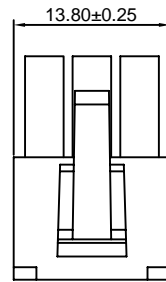

C4201HF-2x3P-B

Unit: mm

C4201HF-2x4P-A/B

4.20mm pitch Dual Row Housing - Special Type

Reference Informations:

- *Material:Nylon 66,UL94V-2 or UL94V-0
- *Suitable CJT C4201F series Terminal
- *Mates with CJT C4201HM or C4201WV special type series dual row Housing or Wafer
- *Color:Black

Ordering Information:

- C4201HF-2x4P - **
- | | |
|-----------------------|---|
| 1 | 2 |
| 1.Part No. | |
| 2.Material: | |
| (blank):UL94V-2/Black | |
| V0:UL94V-0/Black | |

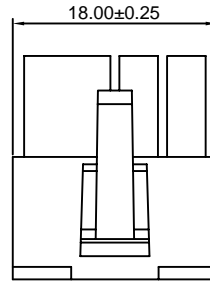
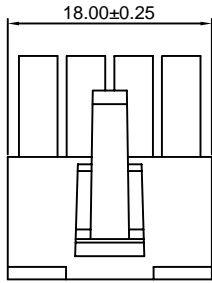
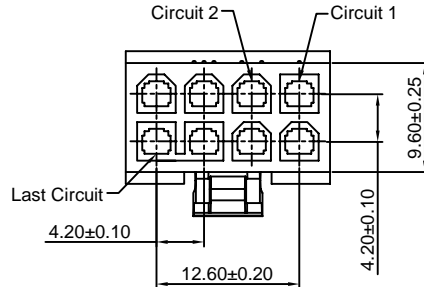
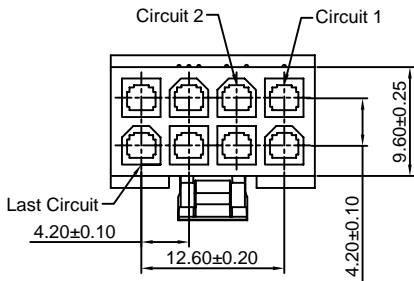
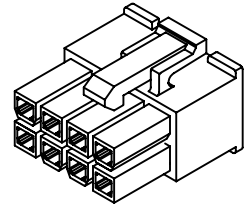

C4201HF-2x4P-A

C4201HF-2x4P-B

Unit: mm

C4201WV-2x3P-B/C

4.20mm pitch Dual Row Housing - Special Type

Reference Informations:

- *Material:Pin:Brass/Tin over Nickel
Insulator:Nylon 66,UL94V-2 or UL94V-0
- *Mates with CJT C4201HF special type series dual row Housing
- *Color:Black

Ordering Information:

- C4201WV-2x3P - **
- | | |
|-----------------------|---|
| 1 | 2 |
| 1.Part No. | |
| 2.Material: | |
| (blank):UL94V-2/Black | |
| V0:UL94V-0/Black | |

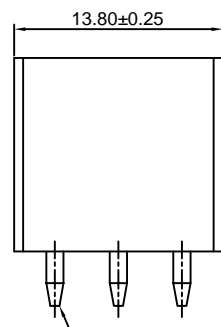
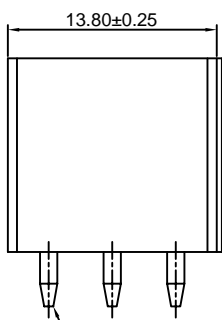
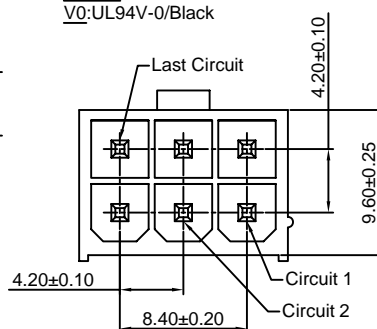
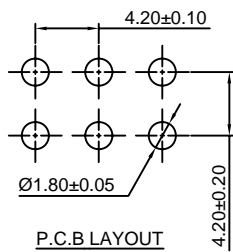
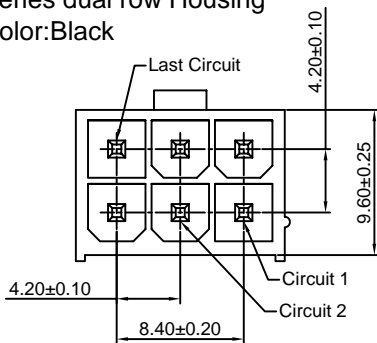
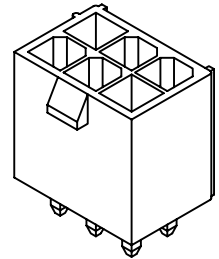

C4201WV-2x3P-B

C4201WV-2x3P-C

Unit: mm

C4201WV-2x4P-A/B

4.20mm pitch Dual Row Housing - Special Type

Reference Informations:

- *Material: Pin: Brass/Tin over Nickel
Insulator: Nylon 66, UL94V-2 or UL94V-0
- *Mates with CJT C4201HF special type series dual row Housing
- *Color: Black

Ordering Information:

- C4201WV-2x4P - **
- | | |
|------------------------|---|
| 1 | 2 |
| 1. Part No. | |
| 2. Material: | |
| (blank): UL94V-2/Black | |
| V0: UL94V-0/Black | |

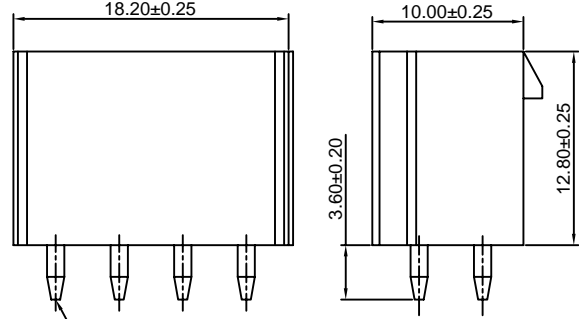
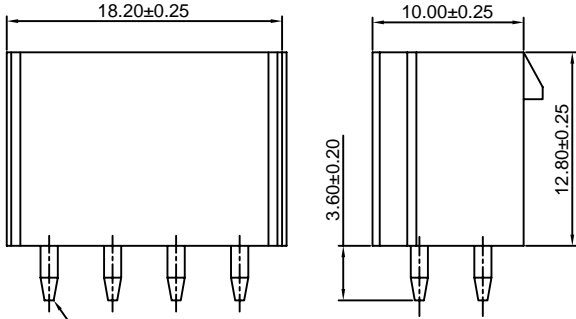
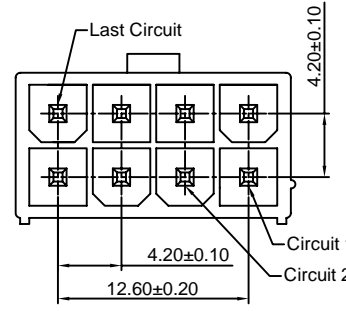

Unit: mm

C4201WR-F-2x3P-A

4.20mm pitch 90° Dual Row Wafer With Foot - Special TYPE

Reference Informations:

- *Material: Pin: Brass/Tin over Nickel
Insulator: Nylon 66, UL94V-2 or UL94V-0
- *Mates with CJT C4201HF-2x3P-B special type series dual row Housing
- *Color: Black

Ordering Information:

- C4201WR-F-2x3P-A - **
- | | |
|------------------------|---|
| 1 | 2 |
| 1. Part No. | |
| 2. Material: | |
| (blank): UL94V-2/Black | |
| V0: UL94V-0/Black | |

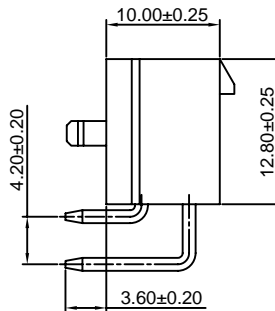
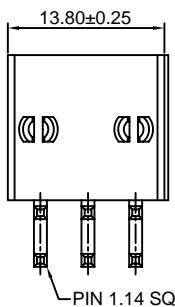
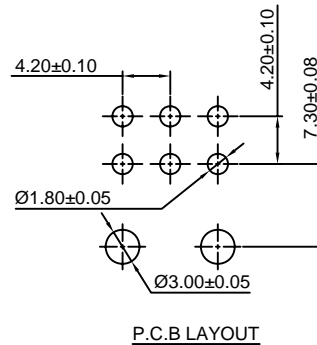
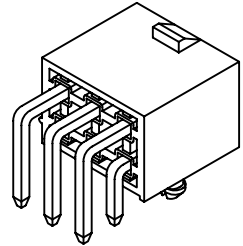

Unit: mm

C4201HFA-2

4.20mm Pitch Dual Row With Panel Mount Ears Housing

Reference Informations:

- *Material: Nylon 66, UL94V-2 or UL94V-0
- *Suitable CJT C4201F series Terminal
- *Mates with CJT C4201HMB series dual row Housing or C4201WVA-F1, C4201WR-F1 series dual row Wafer
- *Color: Natural

Ordering Information:

C4201HFA-2xXP - **
1 2

1. Part No.

2. Material:

(blank): UL94V-2/Natural
V0: UL94V-0/White

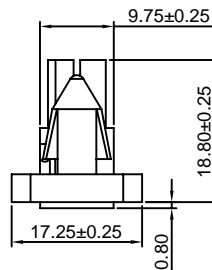
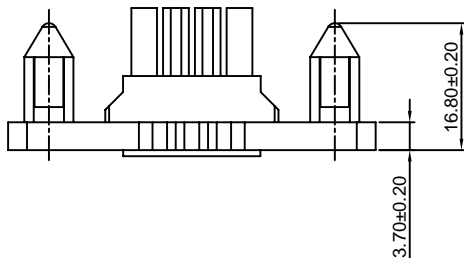
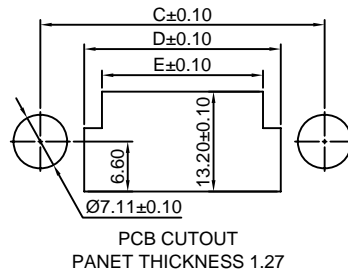
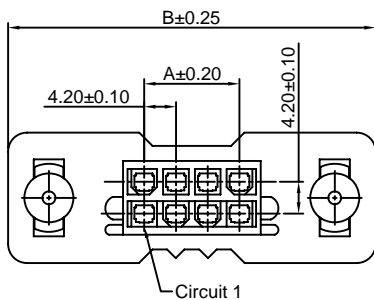
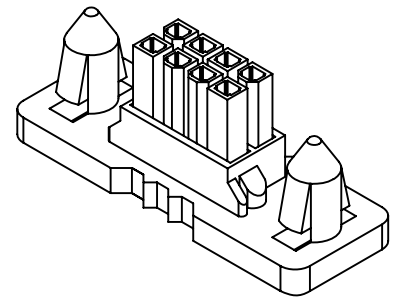

Ordering Information & Dimensions:

PART NO.	Dimensions				
	A	B	C	D	E
C4201HFA-2x1P	-----	36.00	25.00	13.20	8.70
C4201HFA-2x2P	4.20	40.20	29.20	17.60	12.90
C4201HFA-2x3P	8.40	44.40	33.40	21.80	17.10
C4201HFA-2x4P	12.60	48.60	37.60	26.00	21.30
C4201HFA-2x5P	16.80	52.80	41.80	30.20	25.50
C4201HFA-2x6P	21.00	57.00	46.00	34.40	29.70
C4201HFA-2x7P	25.20	61.20	50.20	38.60	33.90
C4201HFA-2x8P	29.40	65.40	54.40	42.80	38.10
C4201HFA-2x9P	33.60	69.60	58.60	47.00	42.30
C4201HFA-2x10P	37.80	73.80	62.80	51.20	46.50
C4201HFA-2x11P	42.00	78.00	67.00	55.40	50.70
C4201HFA-2x12P	46.20	82.20	71.20	59.60	54.90
C4201HFA-2x18P	71.40	107.40	96.40	81.50	76.78

Unit: mm

C4201HV-2

4.20mm Pitch Vertical Dual Row Receptacle Header

Reference Informations:

- *Material: Nylon 66, UL94V-2 or UL94V-0
- *Mates with CJT C4201HMB series dual row Housing or C4201WVA-F1, C4201WR-F1 series dual row Wafer
- *Color: Natural

Ordering Information:

C4201HV-2xXP - **
1 2

1. Part No.

2. Material:

(blank): UL94V-2/Natural
V0: UL94V-0/White

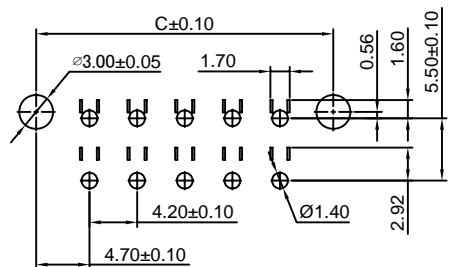

PCB LAYOUT: Component Side
Recommended PCB Thickness 1.78MAX

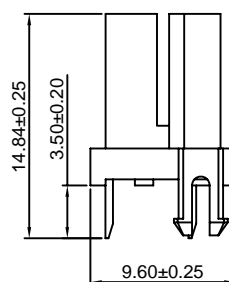
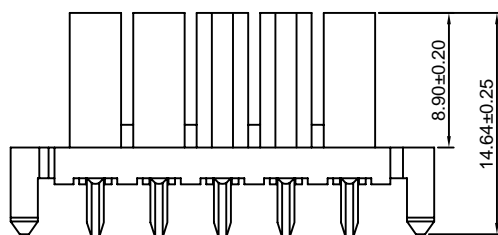
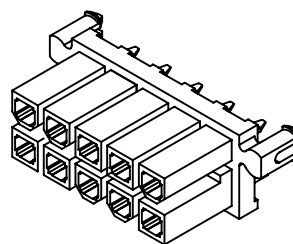
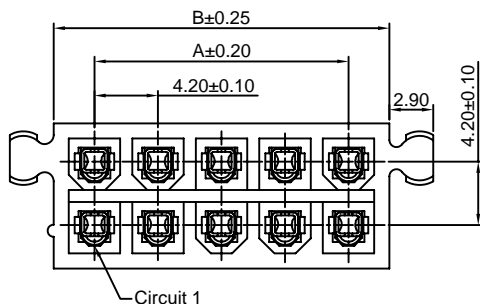

Ordering Information & Dimensions:

PART NO.	Dimensions		
	A	B	C
C4201HV-2x1P	-----	5.40	9.40
C4201HV-2x2P	4.20	9.60	13.60
C4201HV-2x3P	8.40	13.80	17.80
C4201HV-2x4P	12.60	18.00	22.00
C4201HV-2x5P	16.80	22.20	26.20
C4201HV-2x6P	21.00	26.40	30.40
C4201HV-2x7P	25.20	30.60	34.60
C4201HV-2x8P	29.40	34.80	38.80
C4201HV-2x9P	33.60	39.00	43.00
C4201HV-2x10P	37.80	43.20	47.20
C4201HV-2x11P	42.00	47.40	51.40
C4201HV-2x12P	46.20	51.60	55.60
C4201HV-2x18P	71.40	76.80	80.80

Unit: mm

C4201HMB-2

4.20mm Pitch Dual Row Housing With Panel Mount Ears

Reference Informations:

- *Material:Nylon 66,UL94V-2 or UL94V-0
- *Suitable CJT C4201M series Terminal
- *Mates with CJT C4201HFA series dual row Housing or C4201HV series dual row Header
- *Color:Natural

Ordering Information:
C4201HMB-2xXP - **
 1
 2
 1.Part No.
 2.Material:
 (blank):UL94V-2/Natural
 V0:UL94V-0/White

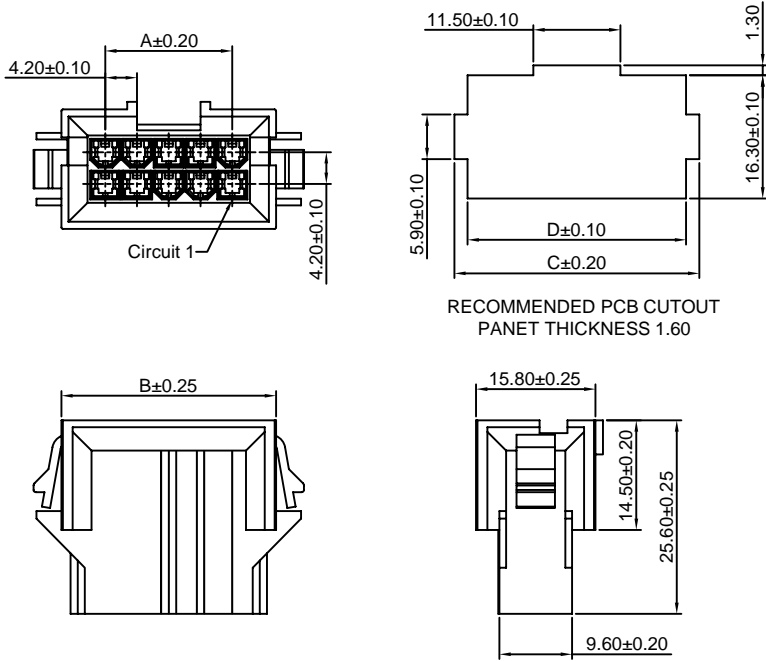
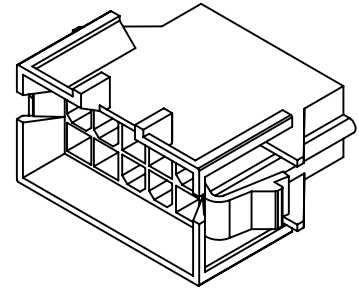

Ordering Information & Dimensions:

PART NO.	Dimensions			
	A	B	C	D
C4201HMB-2x1P	----	11.60	15.60	12.10
C4201HMB-2x2P	4.20	15.80	19.80	16.30
C4201HMB-2x3P	8.40	20.00	24.00	20.50
C4201HMB-2x4P	12.60	24.20	28.20	24.70
C4201HMB-2x5P	16.80	28.40	32.40	28.90
C4201HMB-2x6P	21.00	32.60	36.60	33.10
C4201HMB-2x7P	25.20	36.80	40.80	37.30
C4201HMB-2x8P	29.40	41.00	45.00	41.50
C4201HMB-2x9P	33.60	45.20	49.20	45.70
C4201HMB-2x10P	37.80	49.40	53.40	49.90
C4201HMB-2x11P	42.00	53.60	57.60	54.10
C4201HMB-2x12P	46.20	57.80	61.80	58.30
C4201HMB-2x18P	71.40	83.00	87.00	83.50

Unit: mm

C4201WVA-F1-2

4.20mm pitch 180° Dual Row Wafer With Foot

Reference Informations:

- *Material:Pin:Brass/Tin over Nickel
Insulator:Nylon 66,UL94V-2 or UL94V-0
- *Mates with CJT C4201HFA, C4201HV series dual row Housing
- *Color:Natural

Ordering Information:
C4201WVA-F1-2xXP - **
 1
 2
 1.Part No.
 2.Material:
 (blank):UL94V-2/Natural
 V0:UL94V-0/White

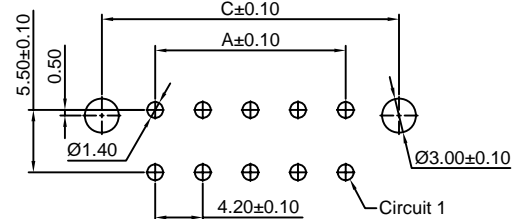

PCB LAYOUT:Component Side
 Recommended PCB Thickness 1.78MMX

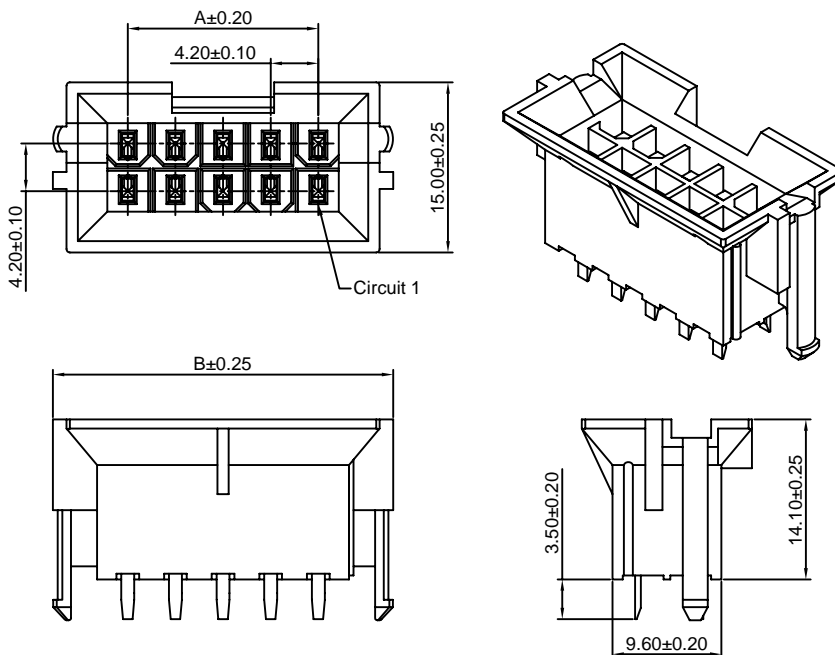

Ordering Information & Dimensions:

PART NO.	Dimensions		
	A	B	C
C4201WVA-F1-2x1P	----	13.20	9.40
C4201WVA-F1-2x2P	4.20	17.40	13.60
C4201WVA-F1-2x3P	8.40	21.60	17.80
C4201WVA-F1-2x4P	12.60	25.80	22.00
C4201WVA-F1-2x5P	16.80	30.00	26.20
C4201WVA-F1-2x6P	21.00	34.20	30.40
C4201WVA-F1-2x7P	25.20	38.40	34.60
C4201WVA-F1-2x8P	29.40	42.60	38.80
C4201WVA-F1-2x9P	33.60	46.80	43.00
C4201WVA-F1-2x10P	37.80	51.00	47.20
C4201WVA-F1-2x11P	42.00	55.20	51.40
C4201WVA-F1-2x12P	46.20	59.40	55.60
C4201WVA-F1-2x18P	71.40	84.60	80.80

Unit: mm

C4201WR-F1-2

4.20mm pitch 90° Dual Row Wafer With Foot

Reference Informations:

- *Material:Pin:Brass/Tin over Nickel
Insulator:Nylon 66,UL94V-2 or UL94V-0
- *Mates with CJT C4201HFA,C4201HV series dual row Housing
- *Color:Natural

Ordering Information:

C4201WR-F1-2xXP - **
1 2

1.Part No.

2.Material:

(blank):UL94V-2/Natural
V0:UL94V-0/White

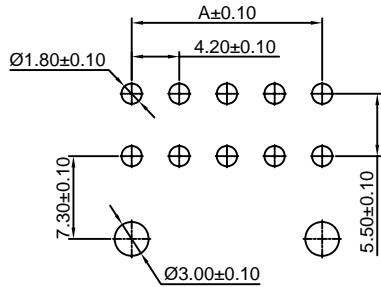
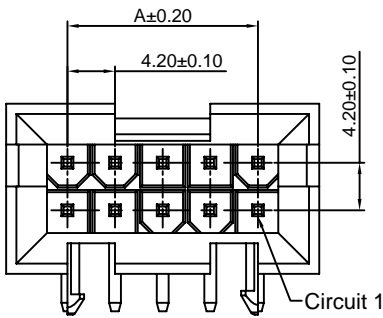
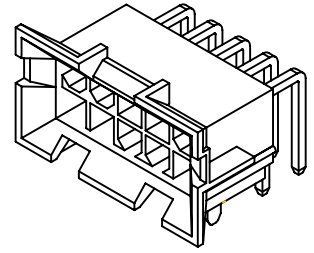

PCB LAYOUT:Component Side
Recommended PCB Thickness 1.78MAX

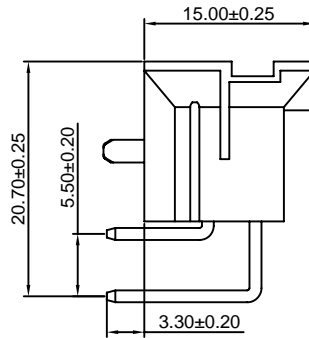
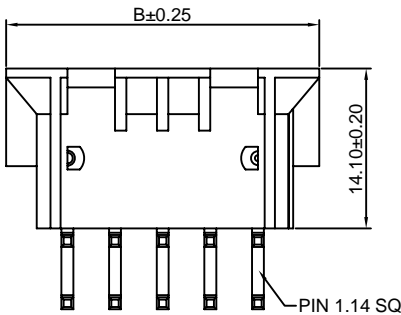

Ordering Information & Dimensions:

PART NO.	Dimensions	
	A	B
C4201WR-F1-2x1P	-----	10.80
C4201WR-F1-2x2P	4.20	15.00
C4201WR-F1-2x3P	8.40	19.20
C4201WR-F1-2x4P	12.60	23.40
C4201WR-F1-2x5P	16.80	27.60
C4201WR-F1-2x6P	21.00	31.80
C4201WR-F1-2x7P	25.20	36.00
C4201WR-F1-2x8P	29.40	40.20
C4201WR-F1-2x9P	33.60	44.40
C4201WR-F1-2x10P	37.80	48.60
C4201WR-F1-2x11P	42.00	52.80
C4201WR-F1-2x12P	46.20	57.00
C4201WR-F1-2x18P	71.40	82.20

Unit: mm

C4201WVB-2

4.20mm pitch 180° Dual Row Wafer With Foot

Reference Informations:

- *Material:Pin:Phosphor Bronze/Tin over Nickel
Insulator:Nylon 66,UL94V-0
- *Mates with CJT C4201HFA,C4201HV series dual row Housing
- *Color:Black

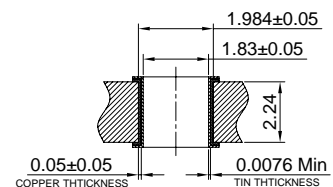
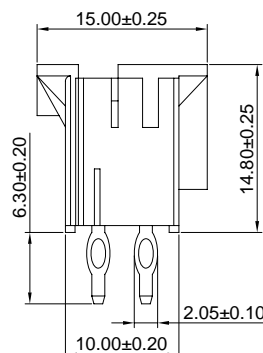
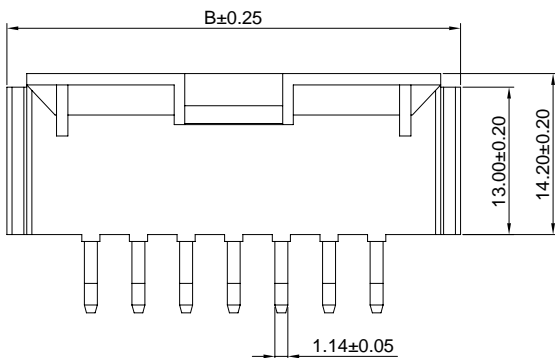
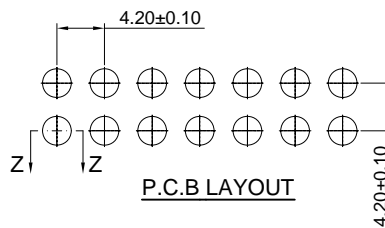
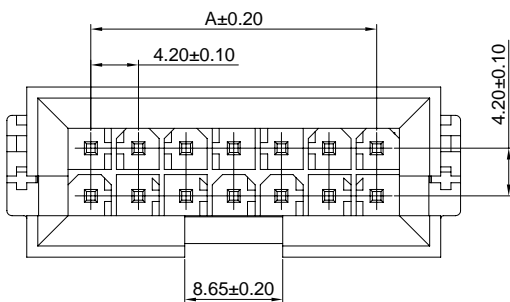
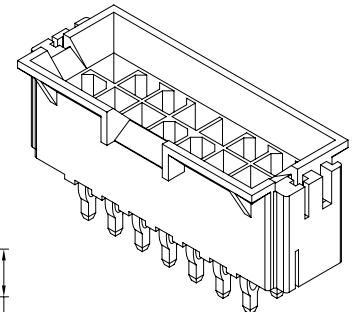

SEC:Z-Z

Ordering Information & Dimensions:

PART NO.	Dimensions	
	A	B
C4201WVB-2x7P	25.20	40.00
C4201WVB-2x9P	33.60	48.40
C4201WVB-2x12P	46.20	61.00

Unit: mm

C4201FS-T

4.19mm pitch Crimp Terminal

Reference Informations:

*Used in CJT C4201HFS C4201HFSB series Housing



Ordering information & Specifications:

Unit:mm

Part NO	Wire Range	Insulation O.D.	Material	Finish	Qty/reel
C4201FS-TP	AWG#20-#24	1.75mm(max)	Phosphor Bronze	Tin over Nickel	10,000 PCS
C4201FS-GP	AWG#20-#24	1.75mm(max)	Phosphor Bronze	Gold over Nickel	10,000 PCS

Optional Gold plating available but MOQ requested

C4201FS-T-H

4.19mm pitch Crimp Terminal

Reference Informations:

*Used in CJT C4201HFS C4201HFSB series Housing

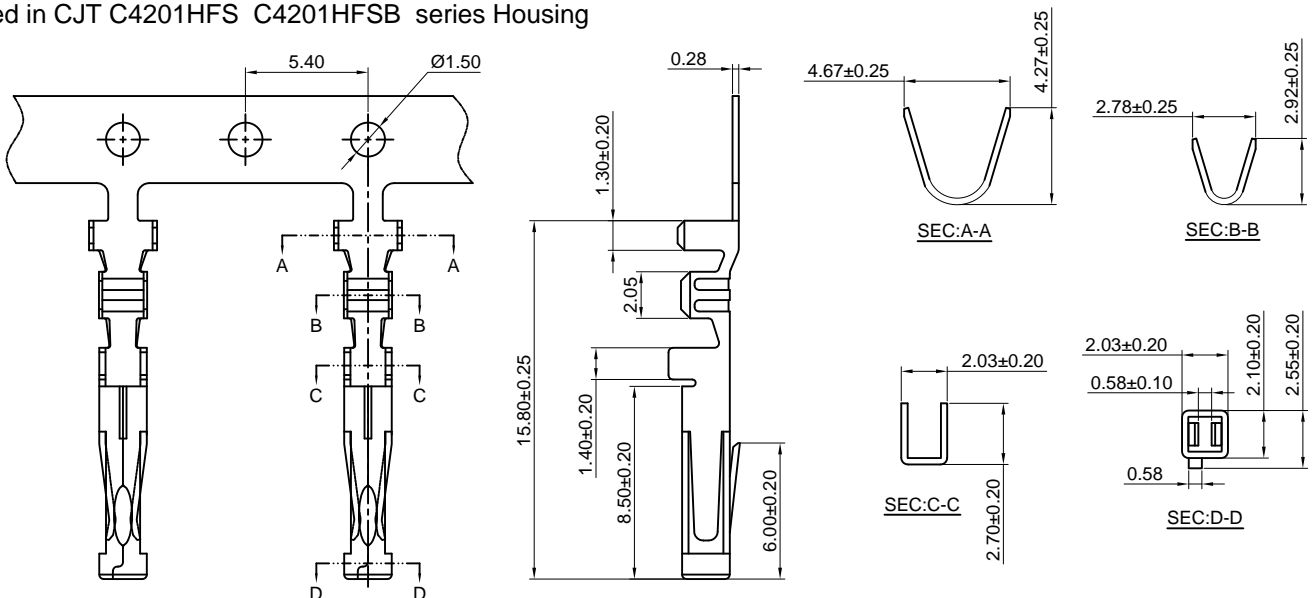

Ordering information & Specifications:

Unit:mm

Part NO	Wire Range	Insulation O.D.	Material	Finish	Qty/reel
C4201FS-TP-H	AWG#16-#20	3.12mm(max)	Phosphor Bronze	Tin over Nickel	10,000 PCS
C4201FS-GP-H	AWG#16-#20	3.12mm(max)	Phosphor Bronze	Gold over Nickel	10,000 PCS

Optional Gold plating available but MOQ requested

C4201FS-T-L

4.19mm pitch Crimp Terminal

Reference Informations:

*Used in CJT C4201HFS C4201HFSB series Housing

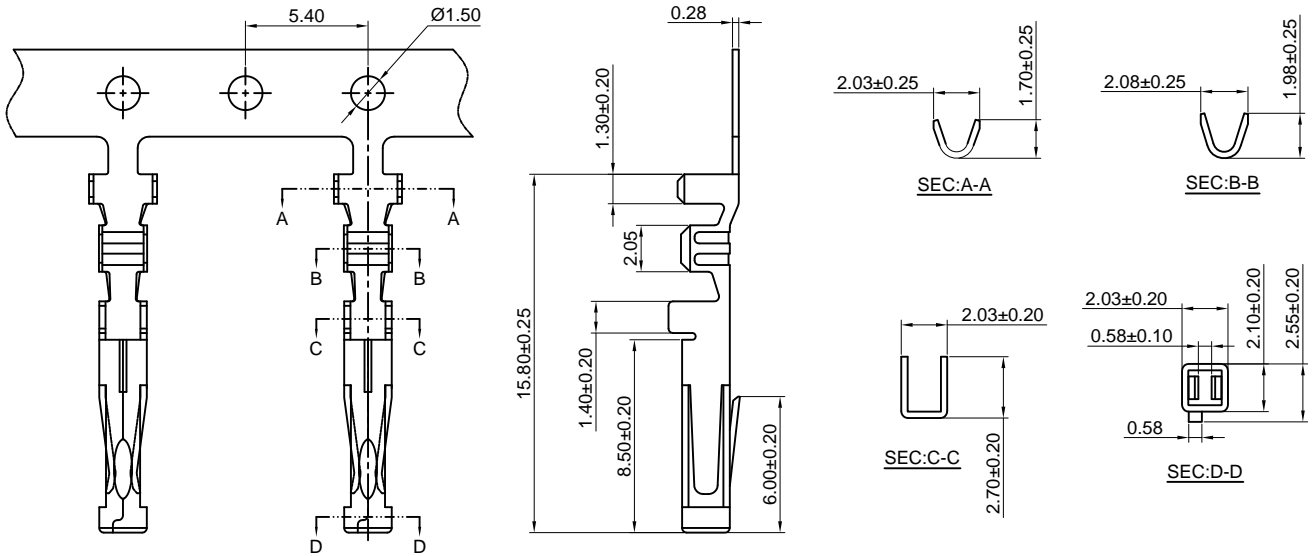

Ordering information & Specifications:

Unit:mm

Part NO	Wire Range	Insulation O.D.	Material	Finish	Qty/reel
C4201FS-TP-L	AWG#24-#26	1.50mm(max)	Phosphor Bronze	Tin over Nickel	10,000 PCS
C4201FS-GP-L	AWG#24-#26	1.50mm(max)	Phosphor Bronze	Gold over Nickel	10,000 PCS

Optional Gold plating available but MOQ requested

C4201HFS

4.19mm Pitch Single Row Housing

Reference Informations:

- *Material:Nylon 66,UL94V-0
- *Suitable CJT C4201FS-T series Terminal
- *Mates with CJT C4201WVS , C4201WRS , C4201WVS-S , C4201WRS-S series single row Wafer
- *Color:Natural

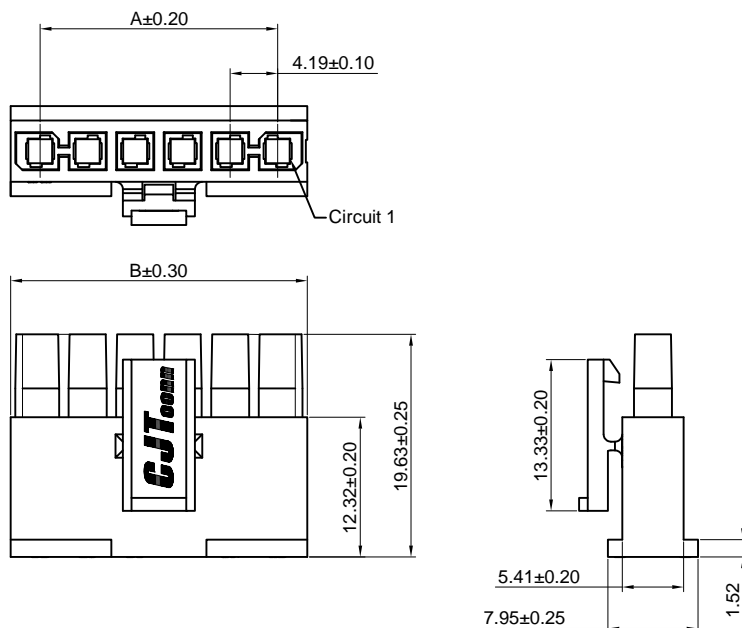

Ordering Information & Dimensions:

PART NO.	Dimensions	
	A	B
C4201HFS-2P	4.19	9.40
C4201HFS-3P	8.38	13.59
C4201HFS-4P	12.57	17.78
C4201HFS-5P	16.76	21.97
C4201HFS-6P	21.95	26.16
C4201HFS-7P	25.14	30.35
C4201HFS-8P	29.33	34.54
C4201HFS-9P	33.52	38.73
C4201HFS-10P	37.71	42.92
C4201HFS-11P	41.90	47.11
C4201HFS-12P	46.09	51.30
C4201HFS-13P	50.28	55.49
C4201HFS-14P	54.47	59.68
C4201HFS-15P	58.66	63.87

Unit: mm

C4201HFSB

4.19mm Pitch Single Row Housing

Reference Informations:

- *Material:Nylon 66,UL94V-0
- *Suitable CJT C4201FS-T series Terminal
- *Mates with CJT C4201WVSB , C4201WRSB , C4201WVSB-S , C4201WRSB-S series single row Wafer
- *Color:Natural

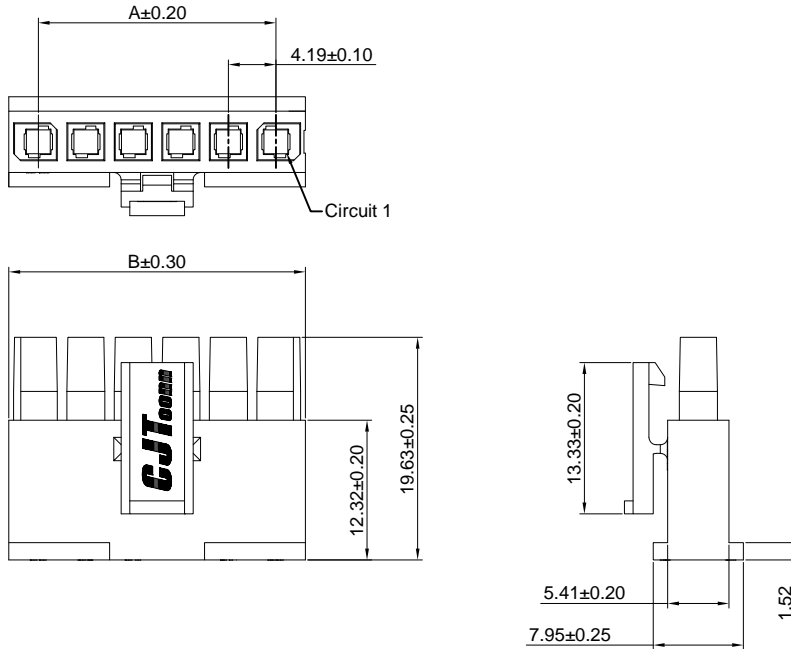

Ordering Information & Dimensions:

PART NO.	Dimensions	
	A	B
C4201HFSB-2P	4.19	9.40
C4201HFSB-3P	8.38	13.59
C4201HFSB-4P	12.57	17.78
C4201HFSB-5P	16.76	21.97
C4201HFSB-6P	21.95	26.16
C4201HFSB-7P	25.14	30.35
C4201HFSB-8P	29.33	34.54
C4201HFSB-9P	33.52	38.73
C4201HFSB-10P	37.71	42.92
C4201HFSB-11P	41.90	47.11
C4201HFSB-12P	46.09	51.30
C4201HFSB-13P	50.28	55.49
C4201HFSB-14P	54.47	59.68
C4201HFSB-15P	58.66	63.87

Unit: mm

C4201HFS-2

4.19mm Pitch Dual Row Housing

Reference Informations:

- *Material:Nylon 66,UL94V-0
- *Suitable CJT C4201FS-T series Terminal
- *Mates with CJT C4201WVS , C4201WRS , C4201WVS-S , C4201WRS-S series dual row Wafer
- *Color:Natural

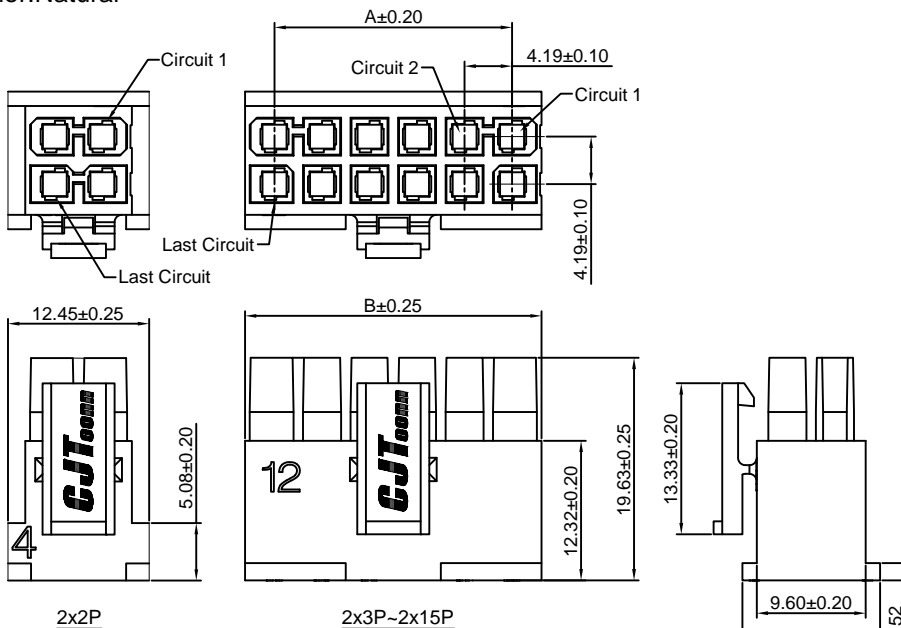

Ordering Information & Dimensions:

PART NO.	Dimensions	
	A	B
C4201HFS-2x2P	4.19	12.45
C4201HFS-2x3P	8.38	13.59
C4201HFS-2x4P	12.57	17.78
C4201HFS-2x5P	16.76	21.97
C4201HFS-2x6P	21.95	26.16
C4201HFS-2x7P	25.14	30.35
C4201HFS-2x8P	29.33	34.54
C4201HFS-2x9P	33.52	38.73
C4201HFS-2x10P	37.71	42.92
C4201HFS-2x11P	41.90	47.11
C4201HFS-2x12P	46.09	51.30
C4201HFS-2x13P	50.28	55.49
C4201HFS-2x14P	54.47	59.68
C4201HFS-2x15P	58.66	63.87

Unit: mm

C4201HFSB-2

4.19mm Pitch Dual Row Housing

Reference Informations:

- *Material:Nylon 66,UL94V-0
- *Suitable CJT C4201FS-T series Terminal
- *Mates with CJT C4201WVSB , C4201WRSB ,C4201WVSB-S , C4201WRSB-S series dual row Wafer
- *Color:Natural

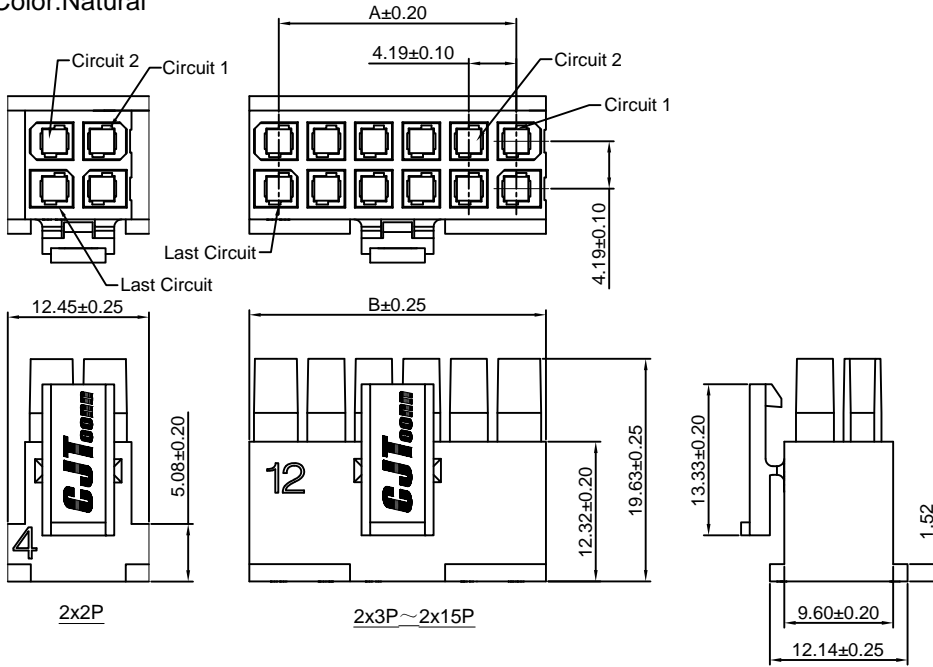

Ordering Information & Dimensions:

PART NO.	Dimensions	
	A	B
C4201HFSB-2x2P	4.19	12.45
C4201HFSB-2x3P	8.38	13.59
C4201HFSB-2x4P	12.57	17.78
C4201HFSB-2x5P	16.76	21.97
C4201HFSB-2x6P	21.95	26.16
C4201HFSB-2x7P	25.14	30.35
C4201HFSB-2x8P	29.33	34.54
C4201HFSB-2x9P	33.52	38.73
C4201HFSB-2x10P	37.71	42.92
C4201HFSB-2x11P	41.90	47.11
C4201HFSB-2x12P	46.09	51.30
C4201HFSB-2x13P	50.28	55.49
C4201HFSB-2x14P	54.47	59.68
C4201HFSB-2x15P	58.66	63.87

Unit: mm

C4201WVS

4.19mm pitch 180° Single Row Wafer

Reference Informations:

- *Material:Pin:Brass/Tin over Nickel
Insulator:LCP , UL94V-0
- *Suitable CJT C4201FS-T series Terminal
- *Mates with CJT C4201HFS series single row housing
- *Color:Black

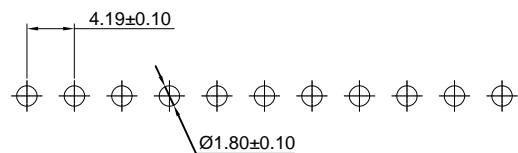

P.C.B LAYOUT

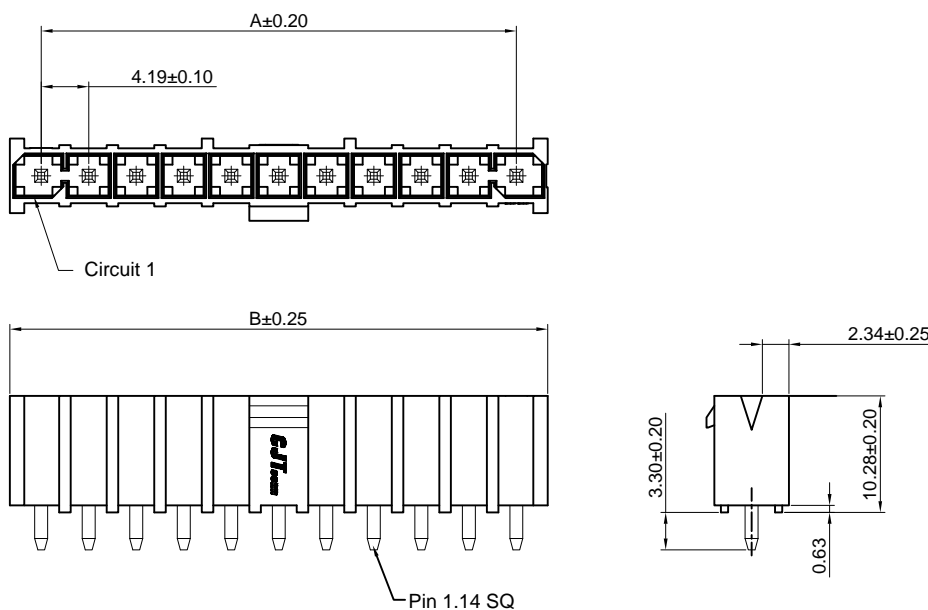

Ordering Information & Dimensions:

PART NO.	Dimensions	
	A	B
C4201WVS-2P	4.19	9.40
C4201WVS-3P	8.38	13.59
C4201WVS-4P	12.57	17.78
C4201WVS-5P	16.76	21.97
C4201WVS-6P	21.95	26.16
C4201WVS-7P	25.14	30.35
C4201WVS-8P	29.33	34.54
C4201WVS-9P	33.52	38.73
C4201WVS-10P	37.71	42.92
C4201WVS-11P	41.90	47.11
C4201WVS-12P	46.09	51.30
C4201WVS-13P	50.28	55.49
C4201WVS-14P	54.47	59.68
C4201WVS-15P	58.66	63.87

Unit: mm

C4201WVSB

4.19mm pitch 180° Single Row Wafer

Reference Informations:

- *Material:Pin:Brass/Tin over Nickel
Insulator:LCP , UL94V-0
- *Suitable CJT C4201FS-T series Terminal
- *Mates with CJT C4201HFSB series single row housing
- *Color:Black

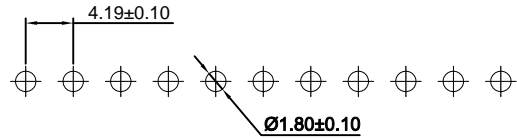
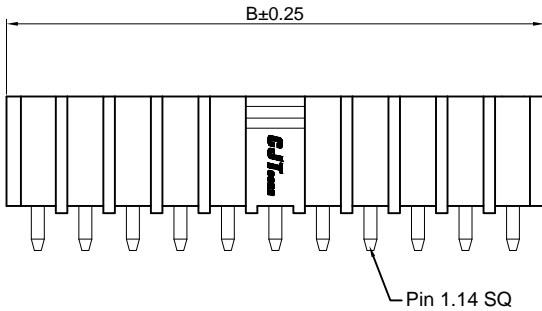
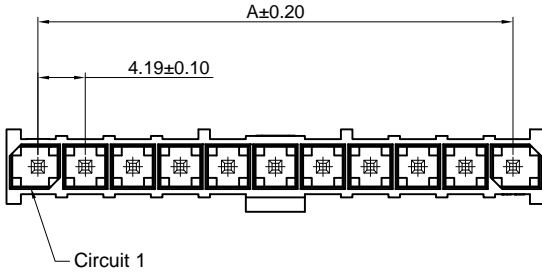

P.C.B LAYOUT

Ordering Information & Dimensions:

PART NO.	Dimensions	
	A	B
C4201WVSB-2P	4.19	9.40
C4201WVSB-3P	8.38	13.59
C4201WVSB-4P	12.57	17.78
C4201WVSB-5P	16.76	21.97
C4201WVSB-6P	21.95	26.16
C4201WVSB-7P	25.14	30.35
C4201WVSB-8P	29.33	34.54
C4201WVSB-9P	33.52	38.73
C4201WVSB-10P	37.71	42.92
C4201WVSB-11P	41.90	47.11
C4201WVSB-12P	46.09	51.30
C4201WVSB-13P	50.28	55.49
C4201WVSB-14P	54.47	59.68
C4201WVSB-15P	58.66	63.87

Unit: mm

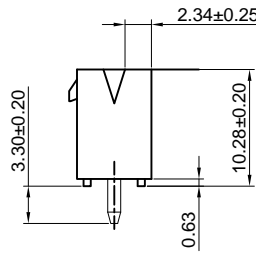

C4201WVS-S

4.19mm Pitch 180° Single Row Wafer-SMT TYPE

Reference Informations:

- *Material:Pin:Brass/Tin over Nickel
Insulator:LCP , UL94V-0
- *Suitable CJT C4201FS-T series Terminal
- *Mates with CJT C4201HFS series single row housing
- *Color:Black

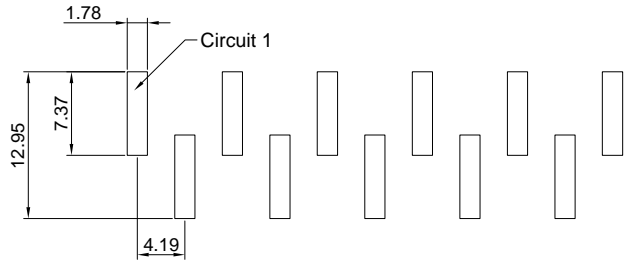
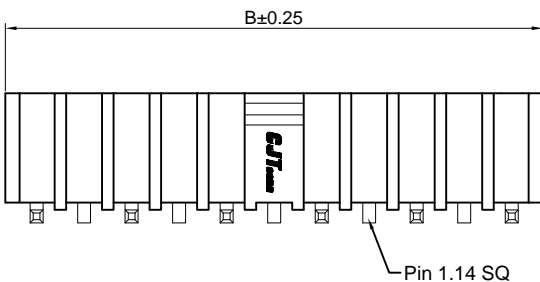
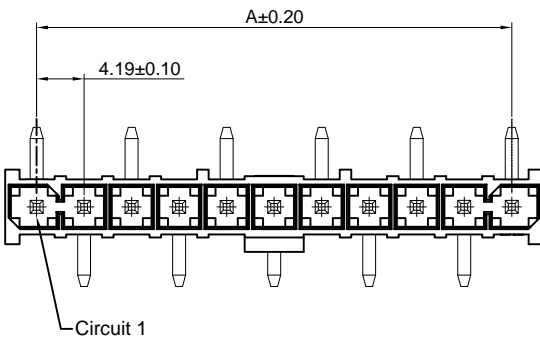

P.C.B LAYOUT

Ordering Information & Dimensions:

PART NO.	Dimensions	
	A	B
C4201WVS-S-2P	4.19	9.40
C4201WVS-S-3P	8.38	13.59
C4201WVS-S-4P	12.57	17.78
C4201WVS-S-5P	16.76	21.97
C4201WVS-S-6P	21.95	26.16
C4201WVS-S-7P	25.14	30.35
C4201WVS-S-8P	29.33	34.54
C4201WVS-S-9P	33.52	38.73
C4201WVS-S-10P	37.71	42.92
C4201WVS-S-11P	41.90	47.11
C4201WVS-S-12P	46.09	51.30
C4201WVS-S-13P	50.28	55.49
C4201WVS-S-14P	54.47	59.68
C4201WVS-S-15P	58.66	63.87

Unit: mm

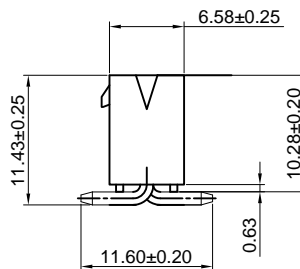

C4201WVSB-S

4.19mm Pitch 180° Single Row Wafer-SMT TYPE

Reference Informations:

- *Material: Pin: Brass/Tin over Nickel
Insulator: LCP, UL94V-0
- *Suitable CJT C4201FS-T series Terminal
- *Mates with CJT C4201HFSB series single row housing
- *Color: Black

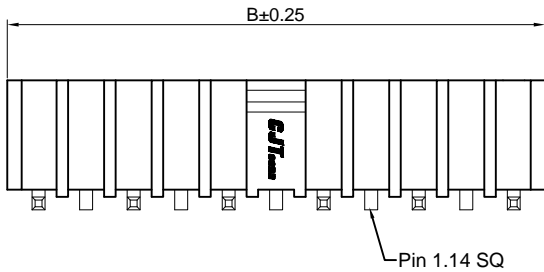
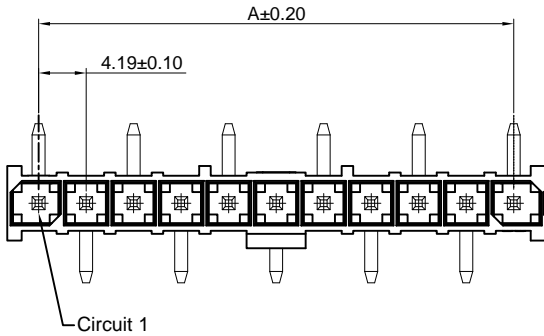

P.C.B LAYOUT

Ordering Information & Dimensions:

PART NO.	Dimensions	
	A	B
C4201WVSB-S-2P	4.19	9.40
C4201WVSB-S-3P	8.38	13.59
C4201WVSB-S-4P	12.57	17.78
C4201WVSB-S-5P	16.76	21.97
C4201WVSB-S-6P	21.95	26.16
C4201WVSB-S-7P	25.14	30.35
C4201WVSB-S-8P	29.33	34.54
C4201WVSB-S-9P	33.52	38.73
C4201WVSB-S-10P	37.71	42.92
C4201WVSB-S-11P	41.90	47.11
C4201WVSB-S-12P	46.09	51.30
C4201WVSB-S-13P	50.28	55.49
C4201WVSB-S-14P	54.47	59.68
C4201WVSB-S-15P	58.66	63.87

Unit: mm

C4201WRS

4.19mm pitch 90° Single Row Wafer

Reference Informations:

- *Material: Pin: Brass/Tin over Nickel
Insulator: LCP, UL94V-0
- *Suitable CJT C4201FS-T series Terminal
- *Mates with CJT C4201HFS series Single row housing
- *Color: Black

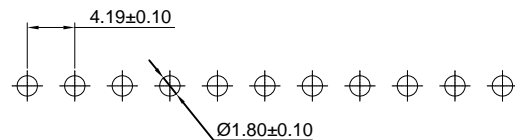
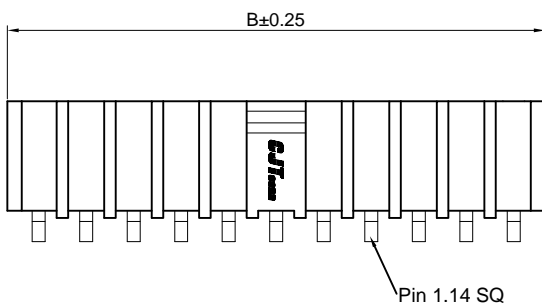
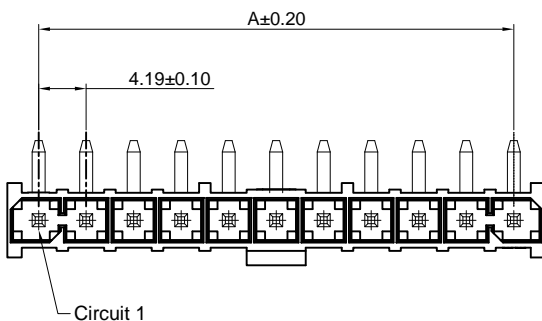

P.C.B LAYOUT

Ordering Information & Dimensions:

PART NO.	Dimensions	
	A	B
C4201WRS-2P	4.19	9.40
C4201WRS-3P	8.38	13.59
C4201WRS-4P	12.57	17.78
C4201WRS-5P	16.76	21.97
C4201WRS-6P	21.95	26.16
C4201WRS-7P	25.14	30.35
C4201WRS-8P	29.33	34.54
C4201WRS-9P	33.52	38.73
C4201WRS-10P	37.71	42.92
C4201WRS-11P	41.90	47.11
C4201WRS-12P	46.09	51.30
C4201WRS-13P	50.28	55.49
C4201WRS-14P	54.47	59.68
C4201WRS-15P	58.66	63.87

Unit: mm

C4201WRSB

4.19mm Pitch 90° Single Row Wafer

Reference Informations:

- *Material: Pin: Brass/Tin over Nickel
Insulator: LCP, UL94V-0
- *Suitable CJT C4201FS-T series Terminal
- *Mates with CJT C4201HFSB series single row housing
- *Color: Black

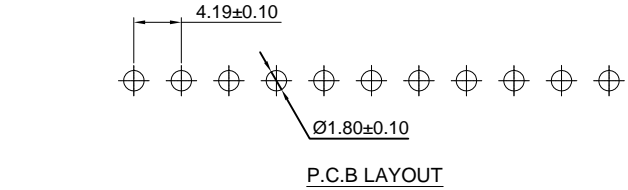
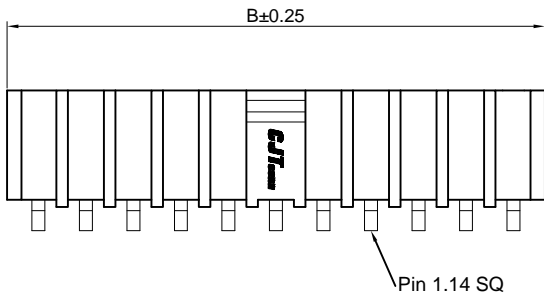
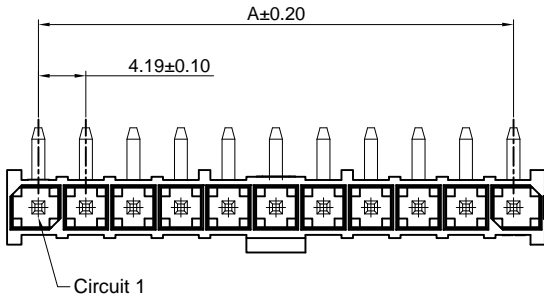

Ordering Information & Dimensions:

PART NO.	Dimensions	
	A	B
C4201WRSB-2P	4.19	9.40
C4201WRSB-3P	8.38	13.59
C4201WRSB-4P	12.57	17.78
C4201WRSB-5P	16.76	21.97
C4201WRSB-6P	21.95	26.16
C4201WRSB-7P	25.14	30.35
C4201WRSB-8P	29.33	34.54
C4201WRSB-9P	33.52	38.73
C4201WRSB-10P	37.71	42.92
C4201WRSB-11P	41.90	47.11
C4201WRSB-12P	46.09	51.30
C4201WRSB-13P	50.28	55.49
C4201WRSB-14P	54.47	59.68
C4201WRSB-15P	58.66	63.87

Unit: mm

C4201WVS-2

4.19mm pitch 180° Dual Row Wafer

Reference Informations:

- *Material: Pin: Brass/Tin over Nickel
Insulator: LCP, UL94V-0
- *Suitable CJT C4201FS-T series Terminal
- *Mates with CJT C4201HFS series dual row housing
- *Color: Black

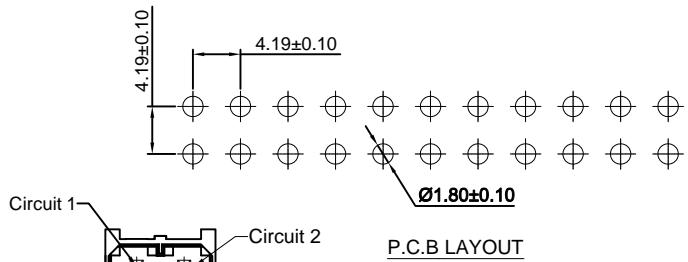
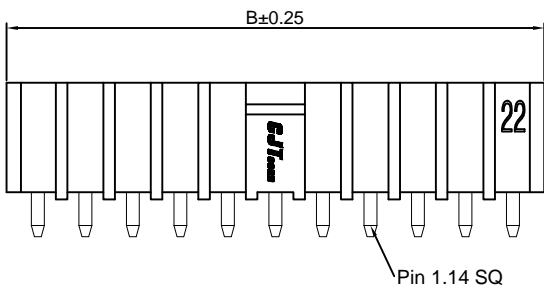
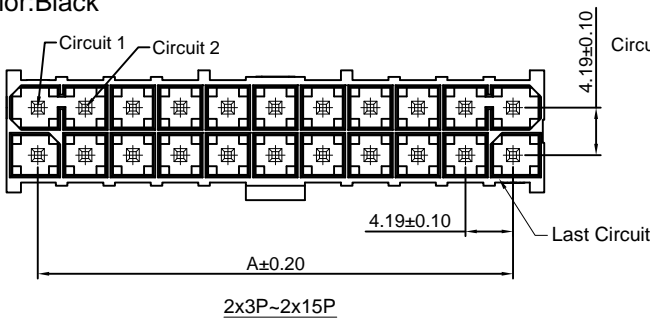

Ordering Information & Dimensions:

PART NO.	Dimensions	
	A	B
C4201WVS-2x2P	4.19	9.40
C4201WVS-2x3P	8.38	13.59
C4201WVS-2x4P	12.57	17.78
C4201WVS-2x5P	16.76	21.97
C4201WVS-2x6P	21.95	26.16
C4201WVS-2x7P	25.14	30.35
C4201WVS-2x8P	29.33	34.54
C4201WVS-2x9P	33.52	38.73
C4201WVS-2x10P	37.71	42.92
C4201WVS-2x11P	41.90	47.11
C4201WVS-2x12P	46.09	51.30
C4201WVS-2x13P	50.28	55.49
C4201WVS-2x14P	54.47	59.68
C4201WVS-2x15P	58.66	63.87

Unit: mm

C4201WVSB-2

4.19mm pitch 180° Dual Row Wafer

Reference Informations:

- *Material: Pin: Brass/Tin over Nickel
Insulator: LCP, UL94V-0
- *Suitable CJT C4201FS-T series Terminal
- *Mates with CJT C4201HFSB series dual row housing
- *Color: Black

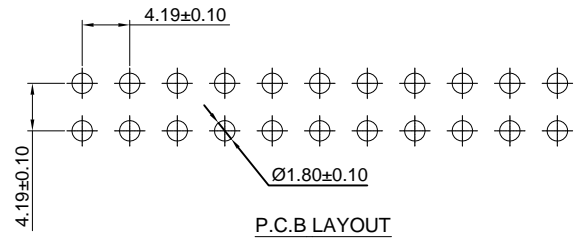
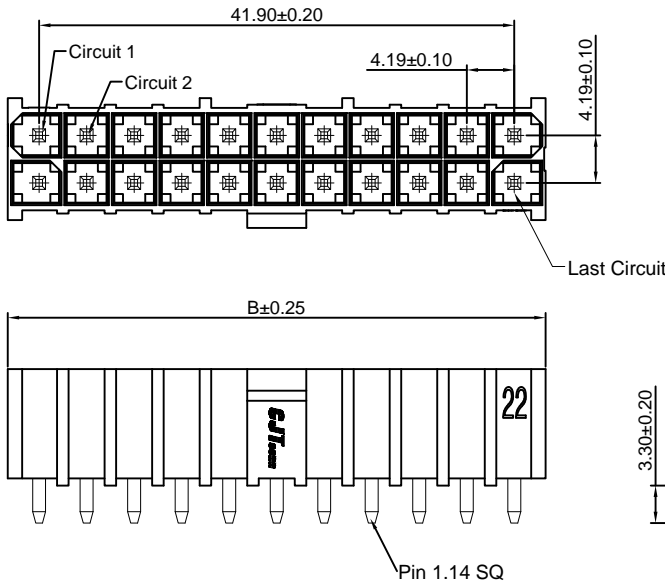

Ordering Information & Dimensions:

PART NO.	Dimensions	
	A	B
C4201WVSB-2x2P	4.19	9.40
C4201WVSB-2x3P	8.38	13.59
C4201WVSB-2x4P	12.57	17.78
C4201WVSB-2x5P	16.76	21.97
C4201WVSB-2x6P	21.95	26.16
C4201WVSB-2x7P	25.14	30.35
C4201WVSB-2x8P	29.33	34.54
C4201WVSB-2x9P	33.52	38.73
C4201WVSB-2x10P	37.71	42.92
C4201WVSB-2x11P	41.90	47.11
C4201WVSB-2x12P	46.09	51.30
C4201WVSB-2x13P	50.28	55.49
C4201WVSB-2x14P	54.47	59.68
C4201WVSB-2x15P	58.66	63.87

Unit: mm

C4201WVS-S-2

4.19mm Pitch 180° Dual Row Wafer-SMT TYPE

Reference Informations:

- *Material: Pin: Brass/Tin over Nickel
Insulator: LCP, UL94V-0
- *Suitable CJT C4201FS-T series Terminal
- *Mates with CJT C4201HFS series dual row housing
- *Color: Black

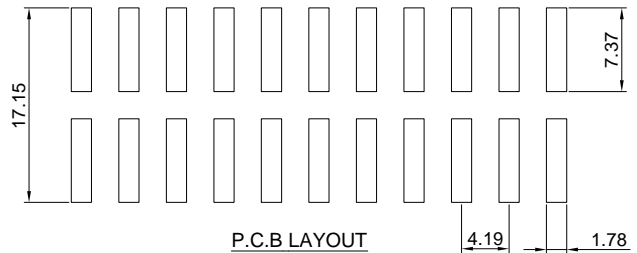
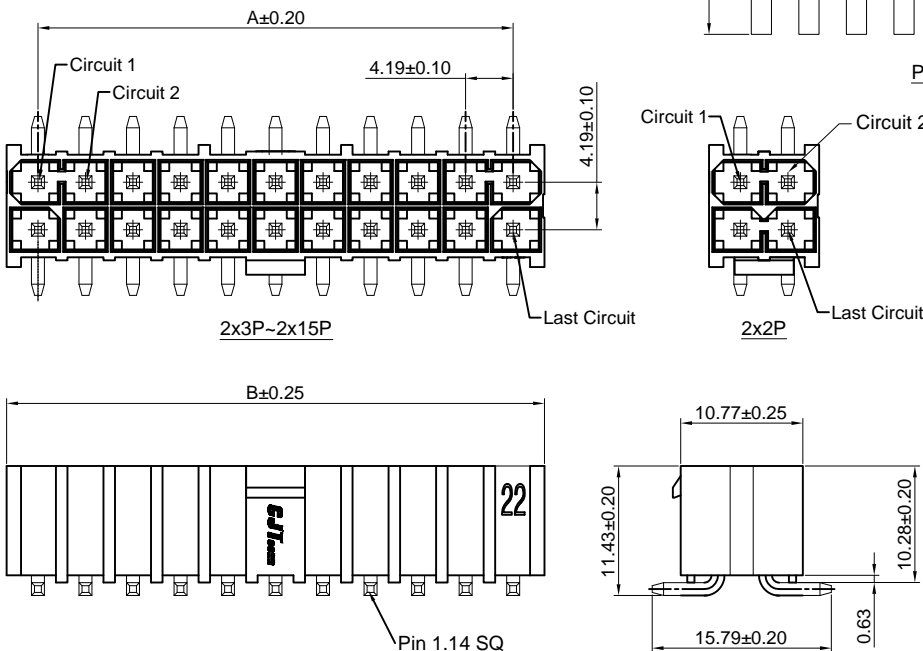

Ordering Information & Dimensions:

PART NO.	Dimensions	
	A	B
C4201WVS-S-2x2P	4.19	9.40
C4201WVS-S-2x3P	8.38	13.59
C4201WVS-S-2x4P	12.57	17.78
C4201WVS-S-2x5P	16.76	21.97
C4201WVS-S-2x6P	21.95	26.16
C4201WVS-S-2x7P	25.14	30.35
C4201WVS-S-2x8P	29.33	34.54
C4201WVS-S-2x9P	33.52	38.73
C4201WVS-S-2x10P	37.71	42.92
C4201WVS-S-2x11P	41.90	47.11
C4201WVS-S-2x12P	46.09	51.30
C4201WVS-S-2x13P	50.28	55.49
C4201WVS-S-2x14P	54.47	59.68
C4201WVS-S-2x15P	58.66	63.87

Unit: mm

C4201WVSB-S-2

4.19mm Pitch 180° Dual Row Wafer-SMT TYPE

Reference Informations:

- *Material: Pin: Brass/Tin over Nickel
Insulator: LCP, UL94V-0
- *Suitable CJT C4201FS-T series Terminal
- *Mates with CJT C4201HFSB series dual row housing
- *Color: Black

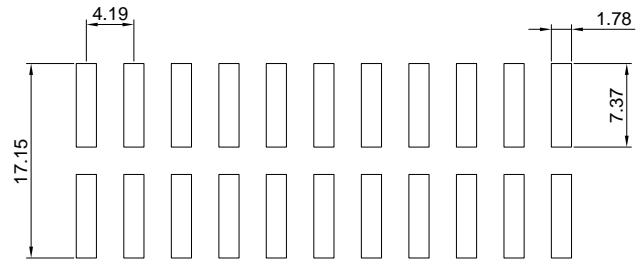
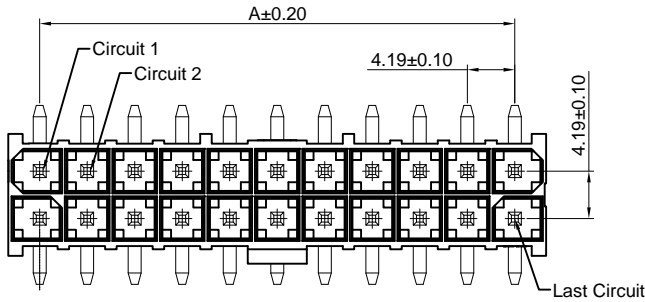

P.C.B LAYOUT

Ordering Information & Dimensions:

PART NO.	Dimensions	
	A	B
C4201WVSB-S-2x2P	4.19	9.40
C4201WVSB-S-2x3P	8.38	13.59
C4201WVSB-S-2x4P	12.57	17.78
C4201WVSB-S-2x5P	16.76	21.97
C4201WVSB-S-2x6P	21.95	26.16
C4201WVSB-S-2x7P	25.14	30.35
C4201WVSB-S-2x8P	29.33	34.54
C4201WVSB-S-2x9P	33.52	38.73
C4201WVSB-S-2x10P	37.71	42.92
C4201WVSB-S-2x11P	41.90	47.11
C4201WVSB-S-2x12P	46.09	51.30
C4201WVSB-S-2x13P	50.28	55.49
C4201WVSB-S-2x14P	54.47	59.68
C4201WVSB-S-2x15P	58.66	63.87

Unit: mm

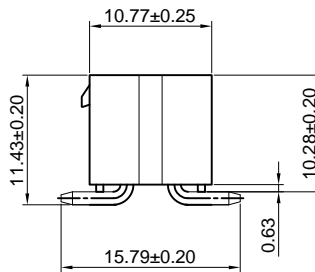
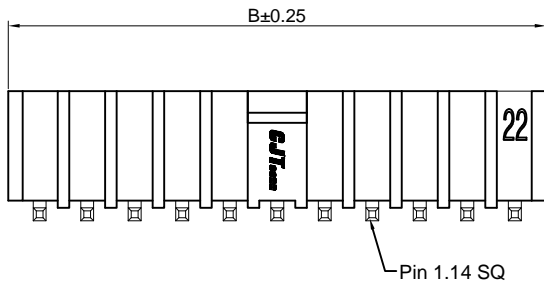

C4201WRS-2

4.19mm pitch 90° Dual Row Wafer

Reference Informations:

- *Material: Pin: Brass/Tin over Nickel
Insulator: LCP, UL94V-0
- *Suitable CJT C4201FS-T series Terminal
- *Mates with CJT C4201HFS series dual row housing
- *Color: Black

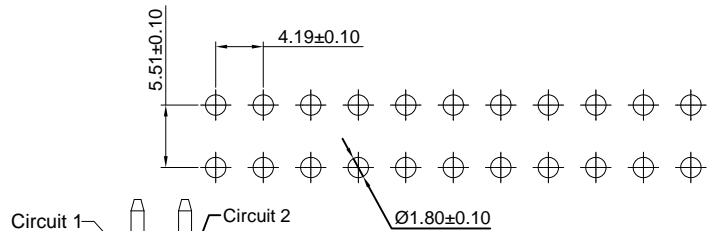
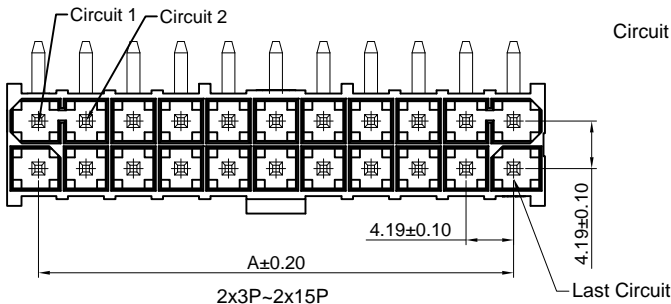

P.C.B LAYOUT

Ordering Information & Dimensions:

PART NO.	Dimensions	
	A	B
C4201WRS-2x2P	4.19	9.40
C4201WRS-2x3P	8.38	13.59
C4201WRS-2x4P	12.57	17.78
C4201WRS-2x5P	16.76	21.97
C4201WRS-2x6P	21.95	26.16
C4201WRS-2x7P	25.14	30.35
C4201WRS-2x8P	29.33	34.54
C4201WRS-2x9P	33.52	38.73
C4201WRS-2x10P	37.71	42.92
C4201WRS-2x11P	41.90	47.11
C4201WRS-2x12P	46.09	51.30
C4201WRS-2x13P	50.28	55.49
C4201WRS-2x14P	54.47	59.68
C4201WRS-2x15P	58.66	63.87

Unit: mm

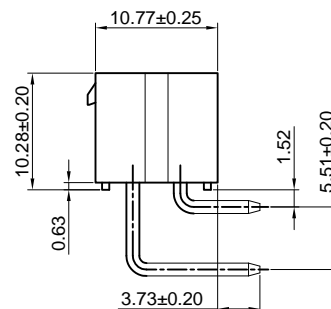
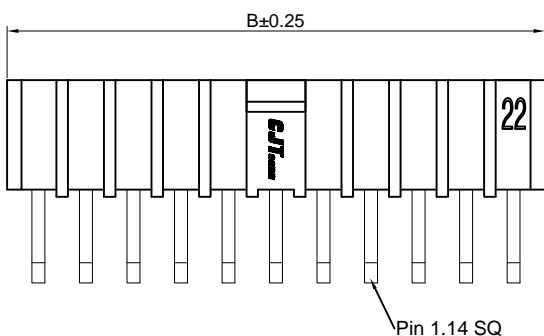

C4201WRSB-2

4.19mm Pitch 90° Dual Row Wafer

Reference Informations:

- *Material: Pin: Brass/Tin over Nickel
Insulator: LCP, UL94V-0
- *Suitable CJT C4201FS-T series Terminal
- *Mates with CJT C4201HFSB series dual row housing
- *Color: Black

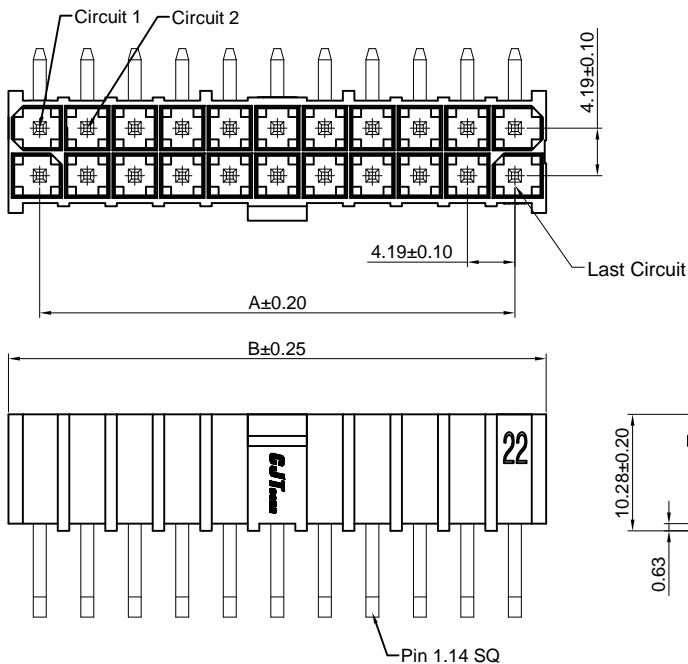

Ordering Information & Dimensions:

PART NO.	Dimensions	
	A	B
C4201WRSB-2x2P	4.19	9.40
C4201WRSB-2x3P	8.38	13.59
C4201WRSB-2x4P	12.57	17.78
C4201WRSB-2x5P	16.76	21.97
C4201WRSB-2x6P	21.95	26.16
C4201WRSB-2x7P	25.14	30.35
C4201WRSB-2x8P	29.33	34.54
C4201WRSB-2x9P	33.52	38.73
C4201WRSB-2x10P	37.71	42.92
C4201WRSB-2x11P	41.90	47.11
C4201WRSB-2x12P	46.09	51.30
C4201WRSB-2x13P	50.28	55.49
C4201WRSB-2x14P	54.47	59.68
C4201WRSB-2x15P	58.66	63.87

Unit: mm

X-ON Electronics

Largest Supplier of Electrical and Electronic Components

Click to view similar products for [Headers & Wire Housings](#) category:

Click to view products by [Changjiang](#) manufacturer:

Other Similar products are found below :

[57102-F02-18ULF](#) [58102-G61-06LF](#) [0009485154](#) [009176003701906](#) [0050291907](#) [00-9021-0611-00-339](#) [02.125.8002.8](#) [609-3404](#) [61062-3](#)
[622-0430](#) [622-3653LF](#) [63453-116](#) [636-1030](#) [636-1427](#) [636-3427](#) [636-4007](#) [641938-9](#) [644827-2](#) [65495-038](#) [65692-001LF](#) [65781-018](#)
[65781-047](#) [65817-010LF](#) [65817-015LF](#) [66207-023LF](#) [67016-026LF](#) [67095-007LF](#) [68631-112](#) [68645-018](#) [68648-049](#) [699319-000](#)
[70.362.1628.0](#) [70-4210](#) [70-4226B](#) [70-4853B](#) [707-5020](#) [707-5028](#) [71.350.2428.0](#) [71961-016LF](#) [733-134](#) [754199-000](#) [760-3052](#) [787-8014-00](#)
[FCN-367T-T012/H](#) [80.063.4001.1](#) [800-90-001-10-001000](#) [800-90-010-10-002000](#) [801-43-002-10-013000](#) [801-43-006-10-002000](#)
[803-41-018-10-001000](#)