

GCH& Plastic-Encapsulate MOSFETS

CJ& ' ' D-channel MOSFET

V _{(BR)DSS}	R _{DS(on)MAX}	I _D
-12V	28mΩ@-4.5V	-6A
	32mΩ@-3.7V	
	40mΩ@-2.5V	
	63mΩ@-1.8V	
	150mΩ@-1.5V	

SOT-23



1. GATE
2. SOURCE
3. DRAIN

FEATURE

- TrenchFET Power MOSFET
- Excellent R_{DS(on)} and Low Gate Charge

APPLICATION

- DC/DC Converter
- Load Switch for Portable Devices
- Battery Switch

MARKING

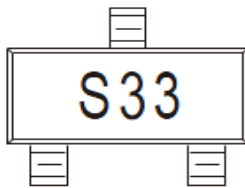

Equivalent Circuit

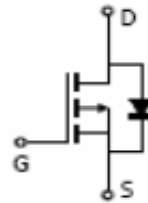

ABSOLUTE MAXIMUM RATINGS (T_a=25°C unless otherwise noted)

Parameter	Symbol	Value	Unit
Drain-Source Voltage	V _{DS}	-12	V
Gate-Source Voltage	V _{GS}	±8	V
Continuous Drain Current	I _D	-6 ^a	A
Pulsed Drain Current (t=300μs)	I _{DM}	-20	A
Power Dissipation	P _D	0.35 ^b	W
		1.1 ^a	W
Thermal Resistance from Junction to Ambient	R _{θJA}	357 ^b	°C/W
		113 ^a	°C/W
Junction Temperature	T _J	150	°C
Storage Temperature	T _{STG}	-55~ +150	°C

a. Device mounted on FR-4 substrate board, with minimum recommended pad layout, single side.

b. Device mounted on no heat sink.

MOSFET ELECTRICAL CHARACTERISTICS

$T_a=25^\circ\text{C}$ unless otherwise specified

Parameter	Symbol	Test Condition	Min	Typ	Max	Unit
Static Characteristics						
Drain-source breakdown voltage	$V_{(BR)DSS}$	$V_{GS} = 0V, I_D = -250\mu A$	-12			V
Zero gate voltage drain current	I_{DSS}	$V_{DS} = -12V, V_{GS} = 0V$			-1	μA
Gate-body leakage current	I_{GSS}	$V_{GS} = \pm 8V, V_{DS} = 0V$			± 0.1	μA
Gate threshold voltage (note 1)	$V_{GS(th)}$	$V_{DS} = V_{GS}, I_D = -250\mu A$	-0.4		-1	V
Drain-source on-resistance (note 1)	$R_{DS(on)}$	$V_{GS} = -4.5V, I_D = -5A$			28	m Ω
		$V_{GS} = -3.7V, I_D = -4.6A$			32	
		$V_{GS} = -2.5V, I_D = -4.3A$			40	
		$V_{GS} = -1.8V, I_D = -1A$			63	
		$V_{GS} = -1.5V, I_D = -0.5A$			150	
Forward transconductance (note 1)	g_{FS}	$V_{DS} = -5V, I_D = -5A$		18		S
Dynamic characteristics (note 2)						
Input Capacitance	C_{iss}	$V_{DS} = -6V, V_{GS} = 0V, f = 1MHz$		1275		pF
Output Capacitance	C_{oss}			255		pF
Reverse Transfer Capacitance	C_{rss}			236		pF
Gate resistance	R_g	$f = 1MHz$	1.9		19	Ω
Total Gate Charge	Q_g	$V_{DS} = -6V, V_{GS} = -4.5V, I_D = -5A$		14	21	nC
Gate-Source Charge	Q_{gs}			2.3		nC
Gate-Drain Charge	Q_{gd}			3.6		nC
Turn-on delay time	$t_{d(on)}$	$V_{DD} = -6V, V_{GEN} = -4.5V, I_D = -4A$ $R_L = 6\Omega, R_{GEN} = 1\Omega$		26	40	ns
Turn-on rise time	t_r			24	40	ns
Turn-off delay time	$t_{d(off)}$			45	70	ns
Turn-off fall time	t_f			20	35	ns
Source-Drain Diode characteristics						
Diode forward current	I_S	$T_C = 25^\circ C$			-1.4	A
Diode pulsed forward current	I_{SM}				-20	A
Diode Forward voltage (note 1)	V_{DS}	$V_{GS} = 0V, I_S = -4A$			-1.2	V
Diode reverse recovery time (note 2)	t_{rr}	$I_F = -4A, di/dt = 100A/\mu s$		24	48	ns
Diode reverse recovery charge (note 2)	Q_{rr}			8	16	nC

- Notes :**
1. Pulse test; pulse width $\leq 300\mu s$, duty cycle $\leq 2\%$.
 2. Guaranteed by design, not subject to production testing.

Typical Characteristics

Output Characteristics

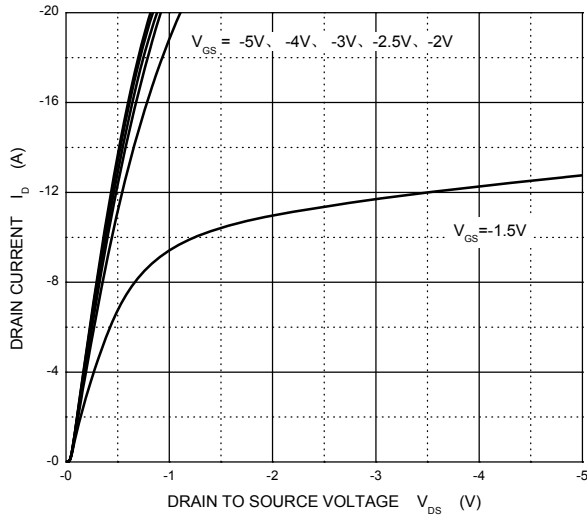

Transfer Characteristics

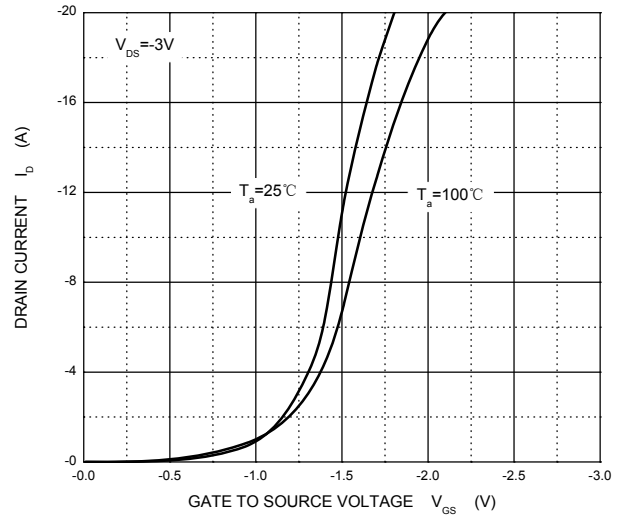

$R_{DS(ON)}$ — I_D

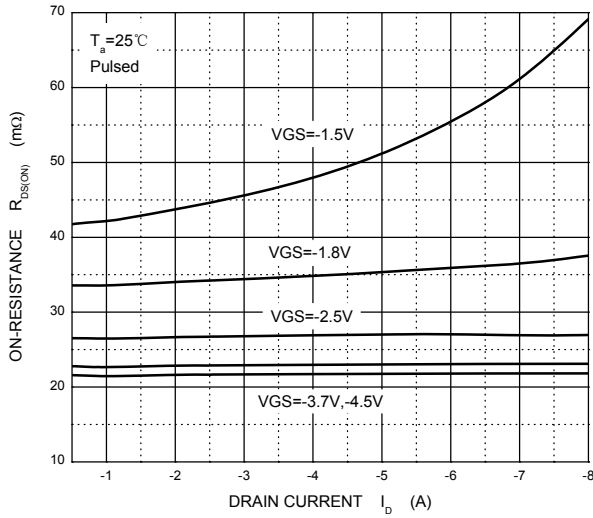

$R_{DS(ON)}$ — V_{GS}

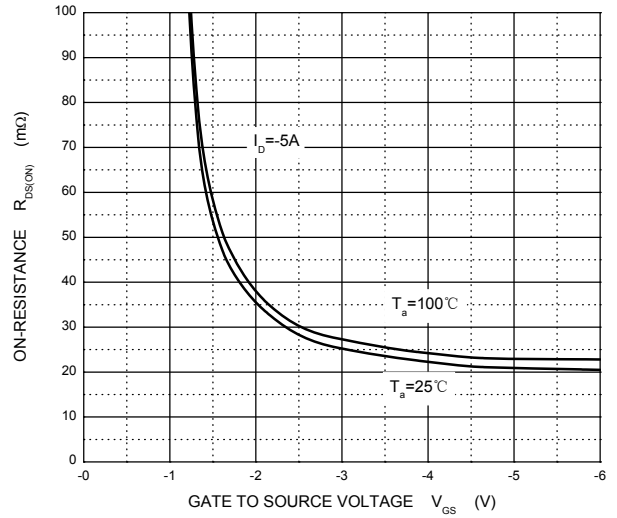

I_S — V_{SD}

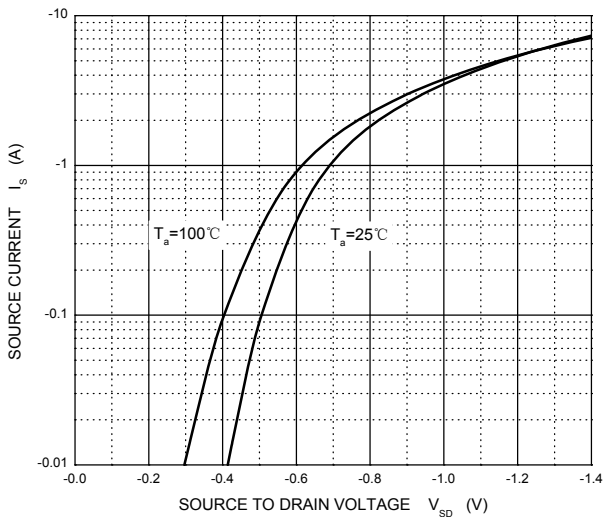

Threshold Voltage

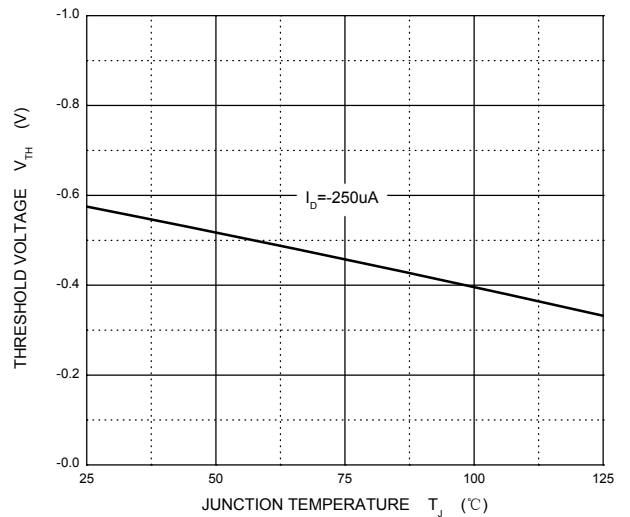

SOT-23 Package Outline Dimensions



Symbol	Dimensions In Millimeters		Dimensions In Inches	
	Min	Max	Min	Max
A	0.900	1.150	0.035	0.045
A1	0.000	0.100	0.000	0.004
A2	0.900	1.050	0.035	0.041
b	0.300	0.500	0.012	0.020
c	0.080	0.150	0.003	0.006
D	2.800	3.000	0.110	0.118
E	1.200	1.400	0.047	0.055
E1	2.250	2.550	0.089	0.100
e	0.950 TYP		0.037 TYP	
e1	1.800	2.000	0.071	0.079
L	0.550 REF		0.022 REF	
L1	0.300	0.500	0.012	0.020
θ	0°	8°	0°	8°

SOT-23 Suggested Pad Layout



- Note:
1. Controlling dimension: in millimeters.
 2. General tolerance: $\pm 0.05\text{mm}$.
 3. The pad layout is for reference purposes only.

NOTICE

JCET reserve the right to make modifications, enhancements, improvements, corrections or other changes without further notice to any product herein. JCET does not assume any liability arising out of the application or use of any product described herein.

SOT-23 Tape and reel

SOT-23 Embossed Carrier Tape

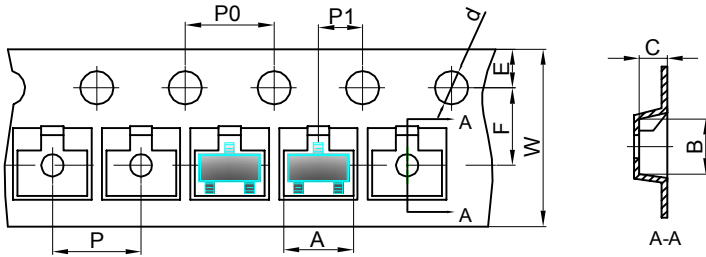

Packaging Description:

SOT-23 parts are shipped in tape. The carrier tape is made from a dissipative (carbon filled) polycarbonate resin. The cover tape is a multilayer film (Heat Activated Adhesive in nature) primarily composed of polyester film, adhesive layer, sealant, and anti-static sprayed agent. These reeled parts in standard option are shipped with 3,000 units per 7" or 17.8cm diameter reel. The reels are clear in color and is made of polystyrene plastic (anti-static coated).

Dimensions are in millimeter										
Pkg type	A	B	C	d	E	F	P0	P	P1	W
SOT-23	3.15	2.77	1.22	Ø1.50	1.75	3.50	4.00	4.00	2.00	8.00

SOT-23 Tape Leader and Trailer

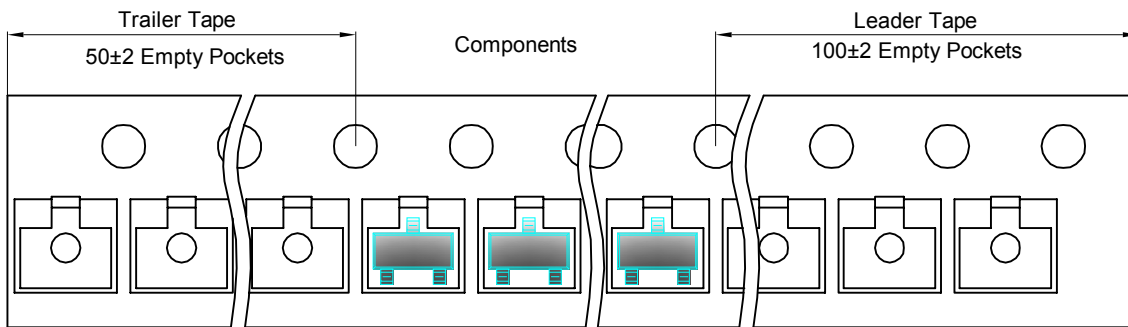

SOT-23 Reel

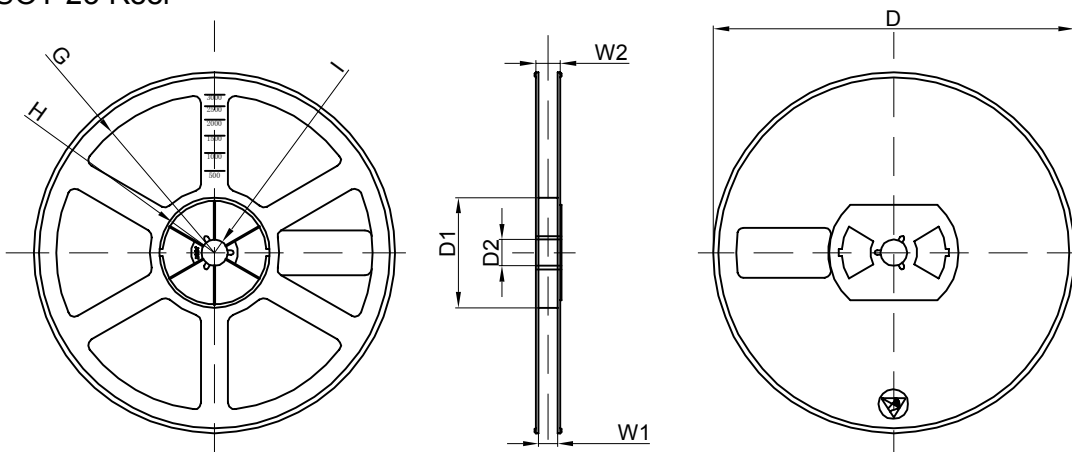

Dimensions are in millimeter								
Reel Option	D	D1	D2	G	H	I	W1	W2
7" Dia	Ø178.00	54.40	13.00	R78.00	R25.60	R6.50	9.50	12.30

REEL	Reel Size	Box	Box Size(mm)	Carton	Carton Size(mm)	G.W.(kg)
3000 pcs	7 inch	30,000 pcs	203×203×195	120,000 pcs	438×438×220	

X-ON Electronics

Largest Supplier of Electrical and Electronic Components

Click to view similar products for [MOSFET](#) category:

Click to view products by [Changjiang](#) manufacturer:

Other Similar products are found below :

[614233C](#) [648584F](#) [FDPF9N50NZ](#) [IRFD120](#) [IRFF430](#) [JANTX2N5237](#) [2N7000](#) [FCA20N60_F109](#) [FDZ595PZ](#) [2SK2267\(Q\)](#) [2SK2545\(Q,T\)](#)
[405094E](#) [423220D](#) [MIC4420CM-TR](#) [VN1206L](#) [614234A](#) [715780A](#) [SSM6J414TU,LF\(T](#) [751625C](#) [PSMN4R2-30MLD](#)
[TK31J60W5,S1VQ\(O](#) [2SK2614\(TE16L1,Q\)](#) [DMN1017UCP3-7](#) [EFC2J004NUZTDG](#) [FCAB21350L1](#) [P85W28HP2F-7071](#) [DMN1053UCP4-7](#)
[NTE2384](#) [NTE2969](#) [NTE6400A](#) [DMN61D9UWQ-13](#) [US6M2GTR](#) [DMN31D5UDJ-7](#) [SSM6P54TU,LF](#) [DMP22D4UFO-7B](#)
[IPS60R3K4CEAKMA1](#) [DMN1006UCA6-7](#) [DMN16M9UCA6-7](#) [STF5N65M6](#) [STU5N65M6](#) [C3M0021120D](#) [DMN13M9UCA6-7](#)
[BSS340NWH6327XTSA1](#) [MCM3400A-TP](#) [DMTH10H4M6SPS-13](#) [IPS60R1K0PFD7SAKMA1](#) [IPS60R360PFD7SAKMA1](#)
[IPS60R600PFD7SAKMA1](#) [IPS60R210PFD7SAKMA1](#) [DMN2990UFB-7B](#)