



## Digital Transistors (Built-in Resistors)

### DTC143ZM/DTC143ZE/DTC143ZUA DTC143ZKA /DTC143ZCA/DTC143ZSA

DIGITAL TRANSISTOR (NPN)



#### FEATURES

- Built-in bias resistors enable the configuration of an inverter circuit without connecting external input resistors(see equivalent circuit)
- The bias resistors consist of thin-film resistors with complete isolation to allow negative biasing of the input.They also have the advantage of almost completely eliminating parasitic effects
- Only the on/off conditions need to be set for operation, making device design easy

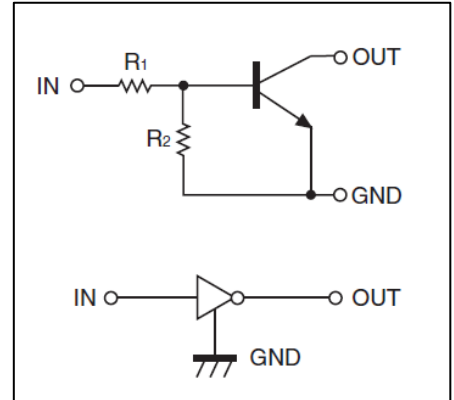
#### • Equivalent Circuit

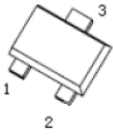
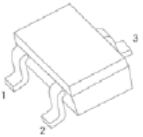
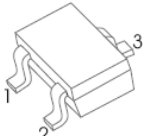
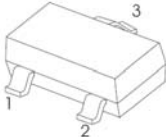
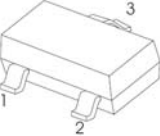

#### PIN CONNENCTIONS and MARKING

<p><b>DTC143ZM</b></p>  <p><b>SOT-723</b></p> <p>1. IN 2. GND 3. OUT</p> <p><b>MARKING: E23</b></p>	<p><b>DTC143ZE</b></p>  <p><b>SOT-523</b></p> <p>1. IN 2. GND 3. OUT</p> <p><b>MARKING: E23</b></p>
<p><b>DTC143ZUA</b></p>  <p><b>SOT-323</b></p> <p>1. IN 2. GND 3. OUT</p> <p><b>MARKING: E23</b></p>	<p><b>DTC143ZKA</b></p>  <p><b>SOT-23-3L</b></p> <p>1. IN 2. GND 3. OUT</p> <p><b>MARKING: E23</b></p>
<p><b>DTC143ZCA</b></p>  <p><b>SOT-23</b></p> <p>1. IN 2. GND 3. OUT</p> <p><b>MARKING: E23</b></p>	<p><b>DTC143ZSA</b></p>  <p><b>TO-92S</b></p> <p>1. GND 2. OUT 3. IN</p>

**MAXIMUM RATINGS(Ta=25°C unless otherwise noted)**

Symbol	Parameter	Limits(DTC143Z□)						Unit
		M	E	UA	CA	KA	SA	
V <sub>CC</sub>	Supply Voltage	50						V
V <sub>IN</sub>	Input Voltage	-5~+30						V
I <sub>O</sub>	Output Current	100						mA
P <sub>D</sub>	Power Dissipation	100	150	200	200	200	300	mW
T <sub>J</sub>	Junction Temperature	150						°C
T <sub>stg</sub>	Storage Temperature	-55~+150						°C

**ELECTRICAL CHARACTERISTICS (Ta=25°C unless otherwise specified)**

Parameter	Symbol	Conditions	Min	Typ	Max	Unit
Input voltage	V <sub>I(off)</sub>	V <sub>CC</sub> =5V, I <sub>O</sub> =100μA	0.5			V
	V <sub>I(on)</sub>	V <sub>O</sub> =0.3V, I <sub>O</sub> =5mA			1.3	V
Output voltage	V <sub>O(on)</sub>	I <sub>O</sub> /I <sub>I</sub> =5mA/0.25mA		0.1	0.3	V
Input current	I <sub>I</sub>	V <sub>I</sub> =5V			1.8	mA
Output current	I <sub>O(off)</sub>	V <sub>CC</sub> =50V, V <sub>I</sub> =0			0.5	μA
DC current gain	G <sub>I</sub>	V <sub>O</sub> =5V, I <sub>O</sub> =10mA	80			
Input resistance	R <sub>1</sub>		3.29	4.7	6.11	kΩ
Resistance ratio	R <sub>2</sub> /R <sub>1</sub>		8	10	12	
Transition frequency	f <sub>T</sub>	V <sub>O</sub> =10V, I <sub>O</sub> =5mA, f=100MHz		250		MHz

# Typical Characteristics

# DTC143ZXX

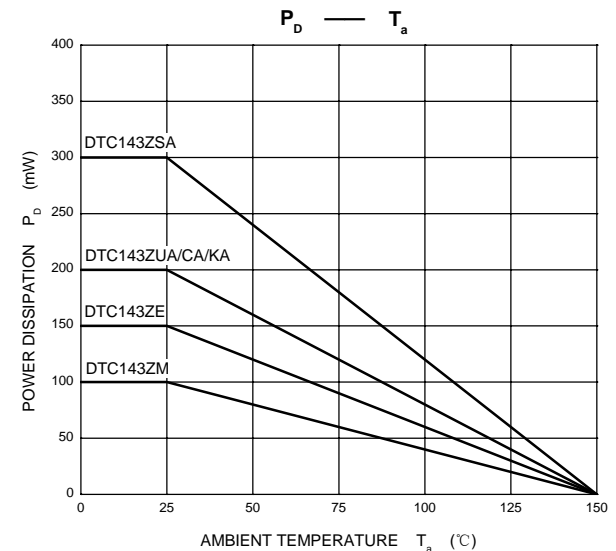
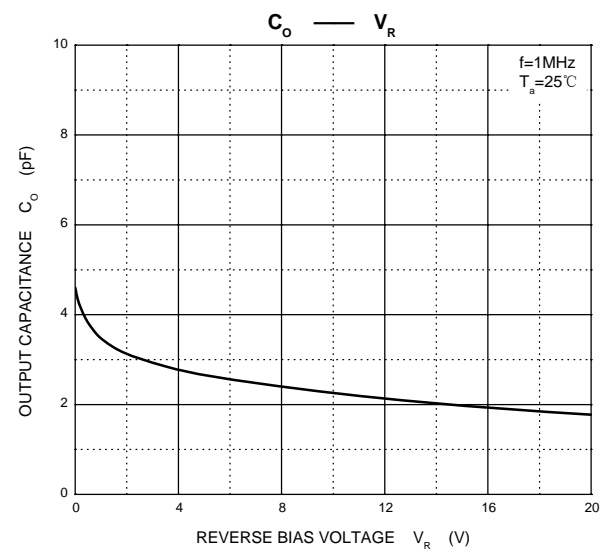
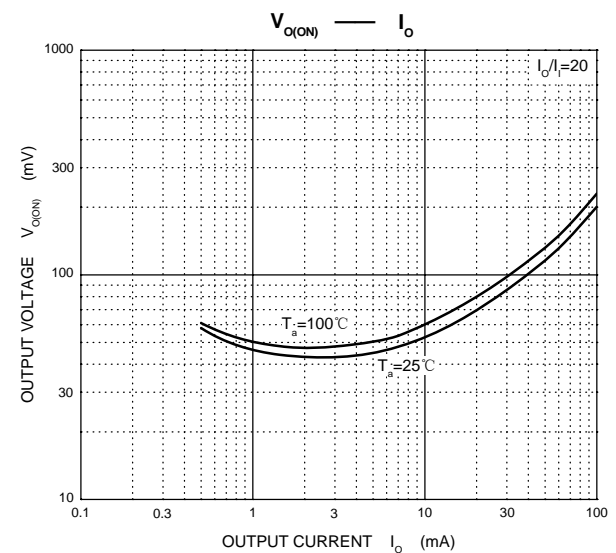
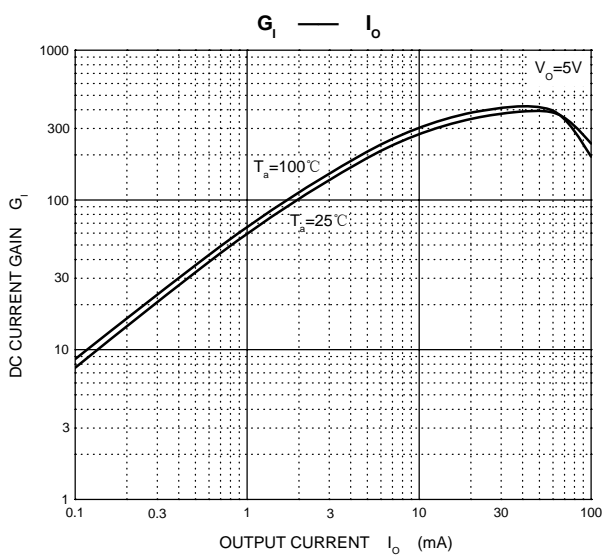
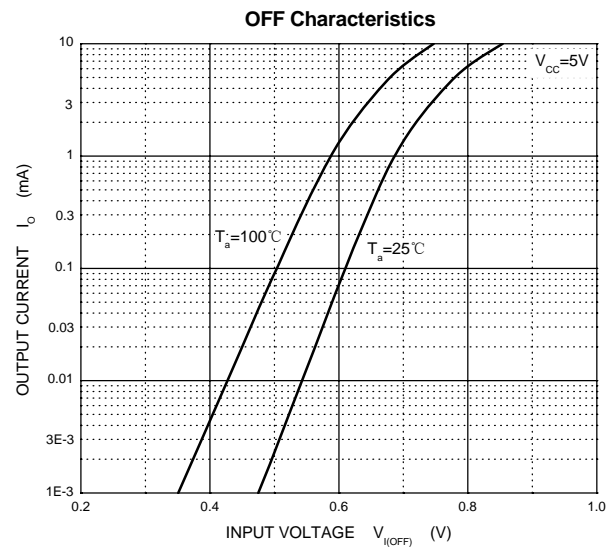
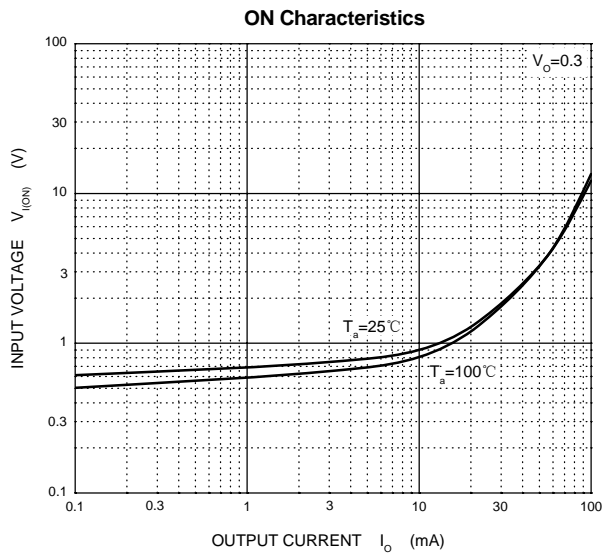

## X-ON Electronics

Largest Supplier of Electrical and Electronic Components

*Click to view similar products for [Bipolar Transistors - Pre-Biased](#) category:*

*Click to view products by [Changjiang](#) manufacturer:*

Other Similar products are found below :

[RN1607\(TE85L,F\)](#) [DRC9A14E0L](#) [DTA124GKAT146](#) [DTA144WETL](#) [DTA144WKAT146](#) [DTC113EET1G](#) [DTC115TETL](#)  
[DTC115TKAT146](#) [DTC124TETL](#) [DTC144VUAT106](#) [MUN5241T1G](#) [NSBA114TDP6T5G](#) [SMUN5330DW1T1G](#) [SSVMUN5312DW1T2G](#)  
[RN1303\(TE85L,F\)](#) [RN1306\(TE85L,F\)](#) [RN4605\(TE85L,F\)](#) [TTEPROTOTYPE79](#) [EMH15T2R](#) [SMUN2214T3G](#) [SMUN5335DW1T1G](#)  
[NSBC143ZPDP6T5G](#) [NSVMUN5113DW1T3G](#) [SMUN5230DW1T1G](#) [SMUN2214T1G](#) [FMA7AT148](#) [DTC114EUA-TP](#)  
[NSVDTA114EET1G](#) [SMUN5237DW1T1G](#) [SMUN5213DW1T1G](#) [SMUN5114DW1T1G](#) [SMUN2111T1G](#) [DTC124ECA-TP](#)  
[DTC123TM3T5G](#) [DTA114ECA-TP](#) [DTA113EM3T5G](#) [DTC113EM3T5G](#) [NSVMUN5135DW1T1G](#) [NSVMUN2237T1G](#)  
[NSVDTC143ZM3T5G](#) [SMUN5335DW1T2G](#) [SMUN5216DW1T1G](#) [NSVMUN5316DW1T1G](#) [NSVMUN5215DW1T1G](#)  
[NSVMUN5213DW1T3G](#) [NSVMUN2112T1G](#) [NSVIMD10AMT1G](#) [NSVEMC2DXV5T1G](#) [NSVDTC144WET1G](#) [NSVDTC123JET1G](#)