



SOT-23 Plastic-Encapsulate Transistors

FMMT491 TRANSISTOR (NPN)

FEATURES

Low equivalent on-resistance

Marking :491

MAXIMUM RATINGS($T_a=25^{\circ}\text{C}$ unless otherwise noted)

Symbol	Parameter	Value	Unit
V_{CB0}	Collector-Base Voltage	80	V
V_{CE0}	Collector-Emitter Voltage	60	V
V_{EB0}	Emitter-Base Voltage	5	V
I_C	Continuous Collector Current	1	A
I_{CM}	Peak Pulse Current	2	A
P_C	Collector Power Dissipation	250	mW
T_j	Junction Temperature	150	$^{\circ}\text{C}$
T_{stg}	Storage Temperature	-55~150	$^{\circ}\text{C}$

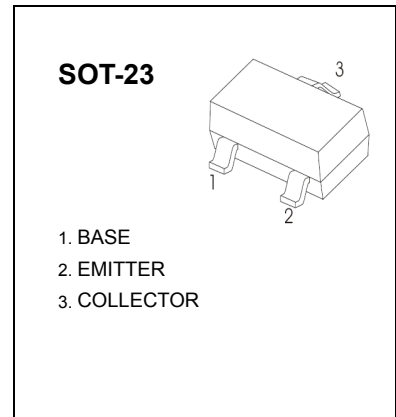

ELECTRICAL CHARACTERISTICS ($T_a=25^{\circ}\text{C}$ unless otherwise specified)

Parameter	Symbol	Test conditions	Min	Typ	Max	Unit
Collector-base breakdown voltage	$V_{(BR)CBO}$	$I_C=100\mu\text{A}, I_E=0$	80			V
Collector-emitter breakdown voltage	$V_{(BR)CEO}^1$	$I_C=10\text{mA}, I_B=0$	60			V
Emitter-base breakdown voltage	$V_{(BR)EBO}$	$I_E=100\mu\text{A}, I_C=0$	5			V
Collector cut-off current	I_{CBO}	$V_{CB}=60\text{V}, I_E=0$			0.1	μA
Emitter cut-off current	I_{EBO}	$V_{EB}=4\text{V}, I_C=0$			0.1	μA
DC current gain	$h_{FE(1)}$	$V_{CE}=5\text{V}, I_C=1\text{mA}$	100			
	$h_{FE(2)}^1$	$V_{CE}=5\text{V}, I_C=500\text{mA}$	100		300	
	$h_{FE(3)}^1$	$V_{CE}=5\text{V}, I_C=1\text{A}$	80			
	$h_{FE(4)}^1$	$V_{CE}=5\text{V}, I_C=2\text{A}$	30			
Collector-emitter saturation voltage	$V_{CE(sat)1}^1$	$I_C=500\text{mA}, I_B=50\text{mA}$			0.25	V
	$V_{CE(sat)2}^1$	$I_C=1\text{A}, I_B=100\text{mA}$			0.5	V
Base-emitter saturation voltage	$V_{BE(sat)}^1$	$I_C=1\text{A}, I_B=100\text{mA}$			1.1	V
Base-emitter voltage	V_{BE}^1	$V_{CE}=5\text{V}, I_C=1\text{A}$			1	V
Transition frequency	f_T	$V_{CE}=10\text{V}, I_C=50\text{mA}, f=100\text{MHz}$	150			MHz
Collector output capacitance	C_{ob}	$V_{CB}=10\text{V}, f=1\text{MHz}$			10	pF

¹Measured under pulsed conditions, Pulse width=300 μs , Duty cycle \leq 2%.

Typical Characteristics

FMMT491

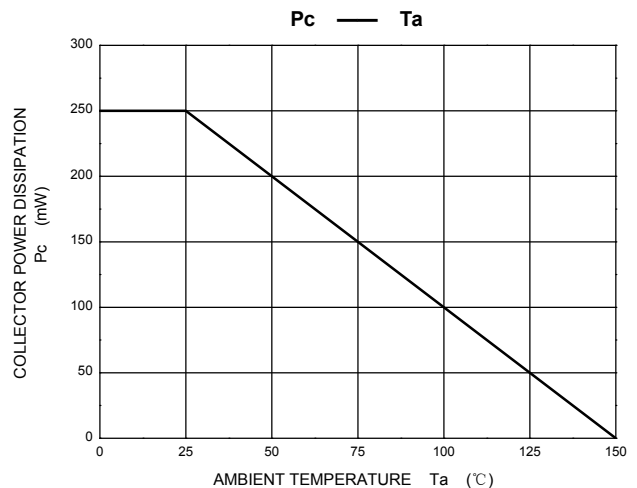
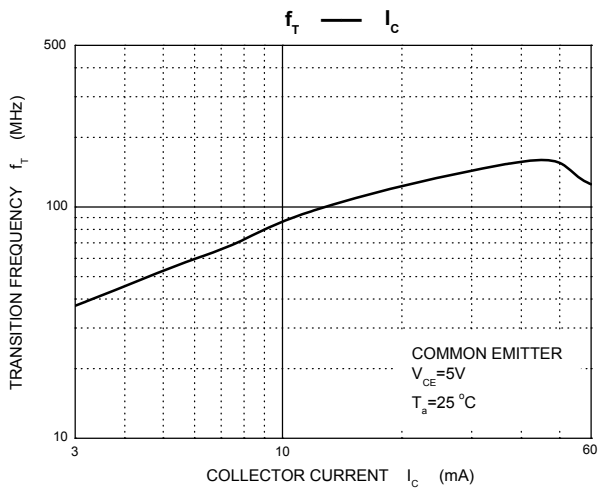
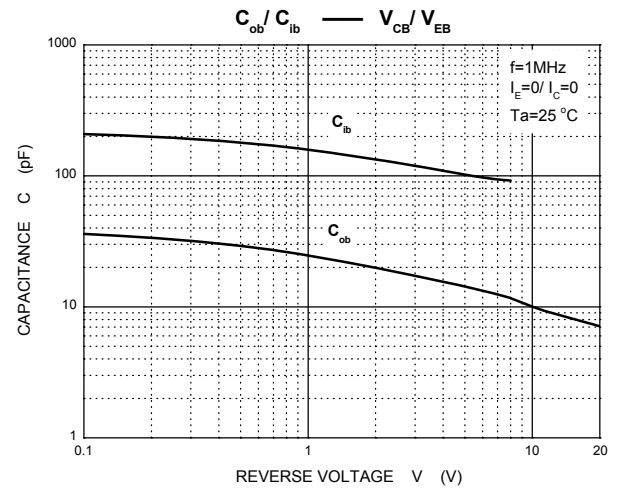
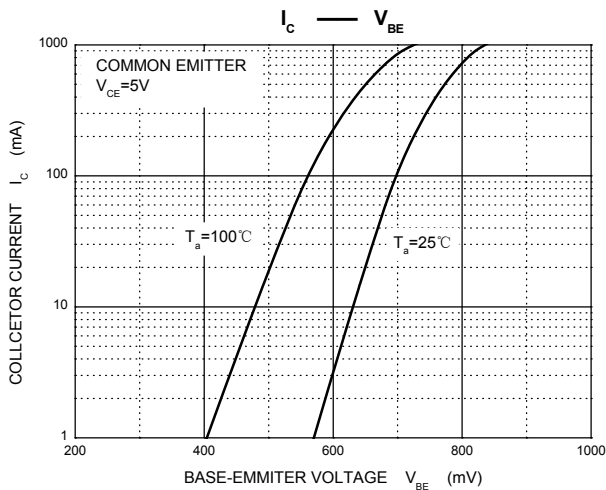
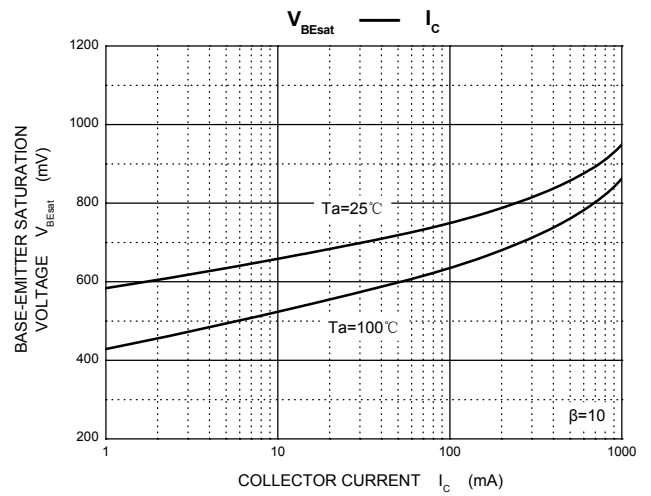
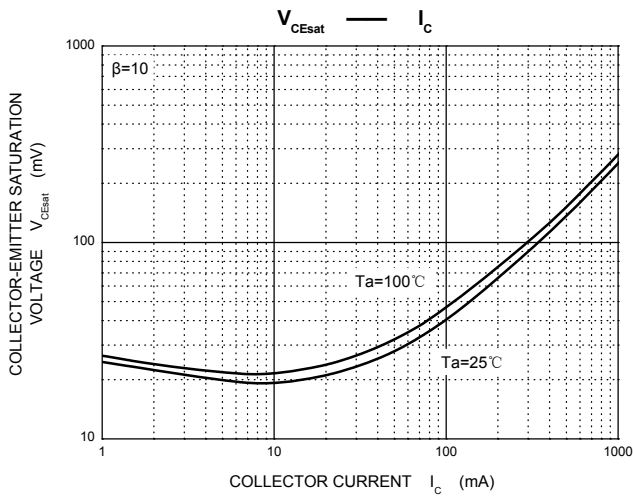
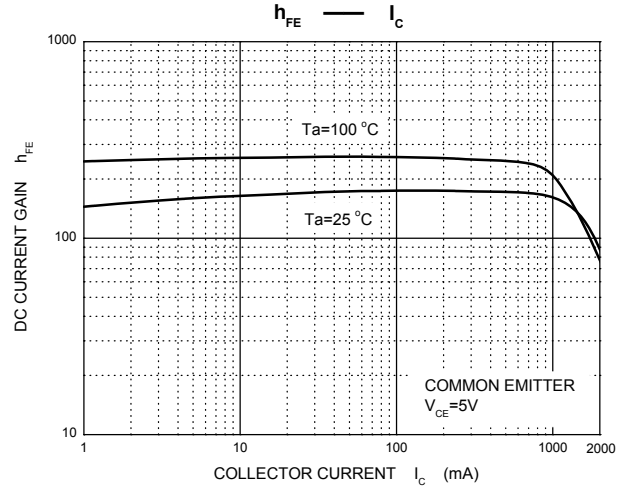
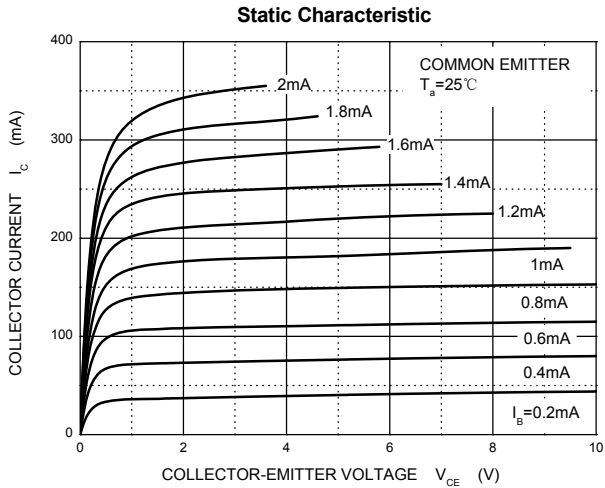

X-ON Electronics

Largest Supplier of Electrical and Electronic Components

Click to view similar products for [Bipolar Transistors - BJT category](#):

Click to view products by [Changjiang manufacturer](#):

Other Similar products are found below :

[619691C](#) [MCH4017-TL-H](#) [MMBT-2369-TR](#) [BC546/116](#) [BC557/116](#) [BSW67A](#) [NJVMJD148T4G](#) [NTE123AP-10](#) [NTE153MCP](#) [NTE16](#)
[NTE195A](#) [NTE92](#) [C4460](#) [2N4401-A](#) [2N6728](#) [2SA1419T-TD-H](#) [2SA2126-E](#) [2SB1204S-TL-E](#) [2SC2712S-GR,LF](#) [2SC5488A-TL-H](#)
[2SD2150T100R](#) [SP000011176](#) [2N2907A](#) [2N3904-NS](#) [2N5769](#) [2SC2412KT146S](#) [2SD1816S-TL-E](#) [CPH6501-TL-E](#) [MCH4021-TL-E](#)
[MJE340](#) [US6T6TR](#) [NJL0281DG](#) [732314D](#) [CPH3121-TL-E](#) [CPH6021-TL-H](#) [873787E](#) [IMZ2AT108](#) [UMX21NTR](#) [MCH6102-TL-E](#)
[NJL0302DG](#) [2N3583](#) [30A02MH-TL-E](#) [NSV40301MZ4T1G](#) [NTE13](#) [NTE26](#) [NTE282](#) [NTE323](#) [NTE350](#) [NTE81](#) [STX83003-AP](#)