

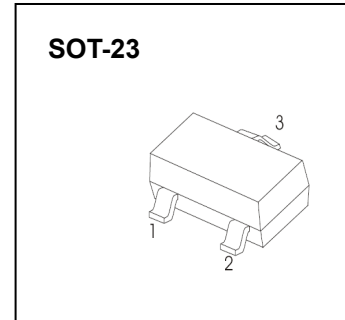

SOT-23 Plastic-Encapsulate Diodes

MMBD4148A/SE/CC/CA SWITCHING DIODE



FEATURES

- Fast Switching Speed
- For General Purpose Switching Applications
- High Conductance

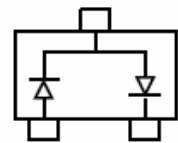
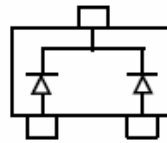
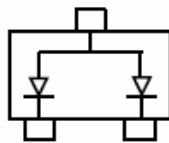
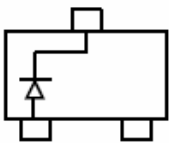

MARKING:

MMBD4148A:5H

MMBD4148CA :D6

MMBD4148CC :D5

MMBD4148SE :D4

Maximum Ratings @Ta=25°C

Parameter	Symbol	Limit	Unit
Non-Repetitive Peak Reverse Voltage	V_{RM}	100	V
Peak Repetitive Peak Reverse Voltage	V_{RRM}	100	V
Working Peak Reverse Voltage	V_{RWM}		
DC Blocking Voltage	V_R		
RMS Reverse Voltage	$V_{R(RMS)}$	53	V
Forward Continuous Current	I_{FM}	300	mA
Average Rectified Output Current	I_O	200	mA
Peak Forward Surge Current @t=1.0µs	I_{FSM}	2.0	A
@ t=1.0s		1.0	
Power Dissipation	P_D	350	mW
Thermal Resistance Junction to Ambient	$R_{\theta JA}$	357	°C/W
Junction Temperature	T_j	150	°C
Storage Temperature	T_{STG}	-55~+150	°C

Electrical Ratings @Ta=25°C

Parameter	Symbol	Min	Typ	Max	Unit	Conditions
Reverse breakdown voltage	$V_{(BR)1}$	100			V	$I_R=100\mu A$
	$V_{(BR)2}$	75			V	$I_R=5\mu A$
Forward voltage	V_F			1	V	$I_F=10mA$
Reverse current	I_{R1}			5	µA	$V_R=75V$
	I_{R2}			25	nA	$V_R=25V$
Capacitance between terminals	C_T			4	pF	$V_R=0V, f=1MHz$
Reverse recovery time	t_{rr}			4	ns	$I_F=I_R=10mA, V_R=6V, I_{rr}=0.1 \times I_R, R_L=100\Omega$

Typical Characteristics

MMBD4148CC

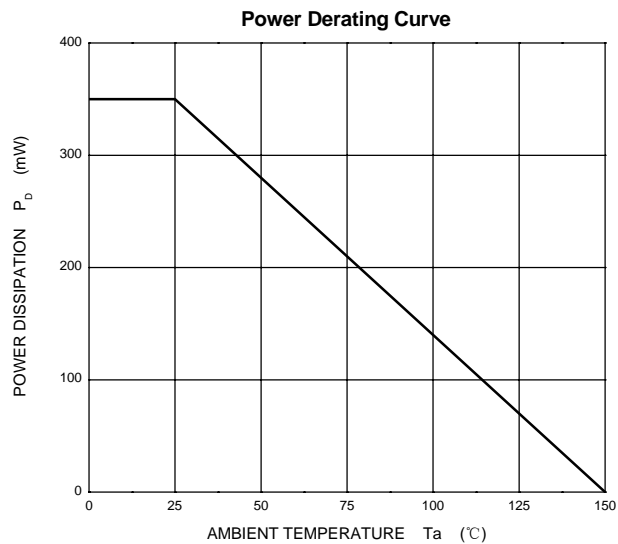
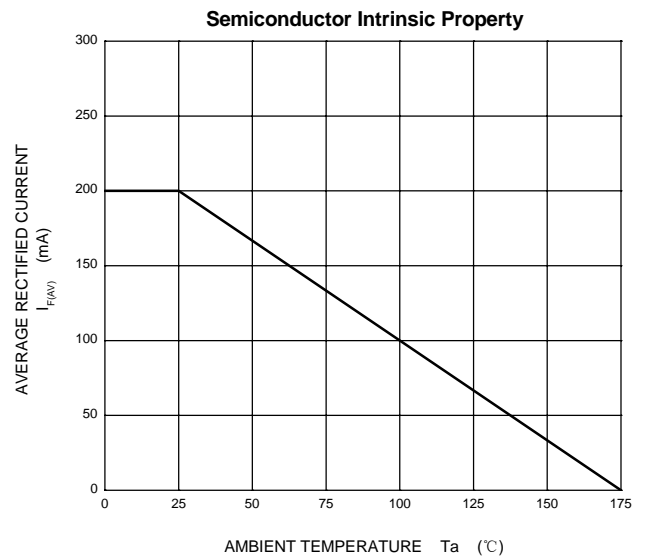
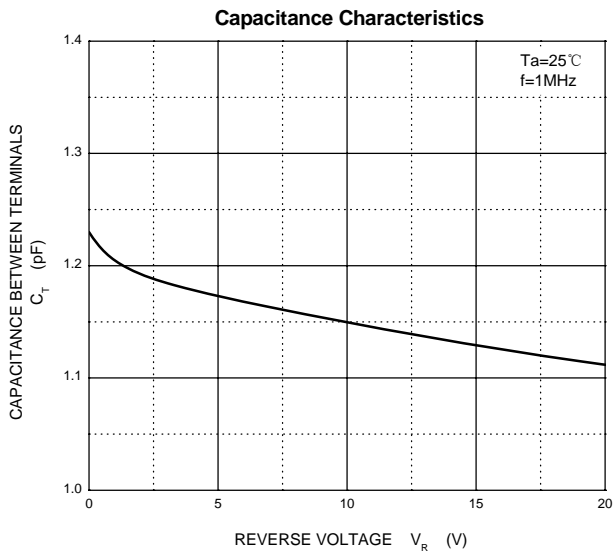
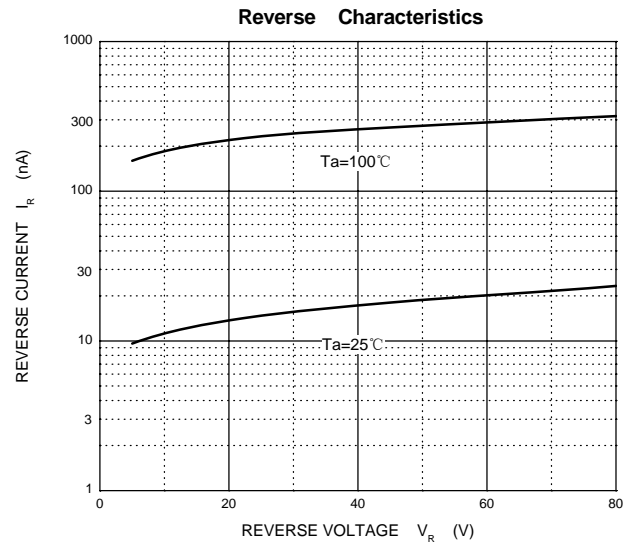
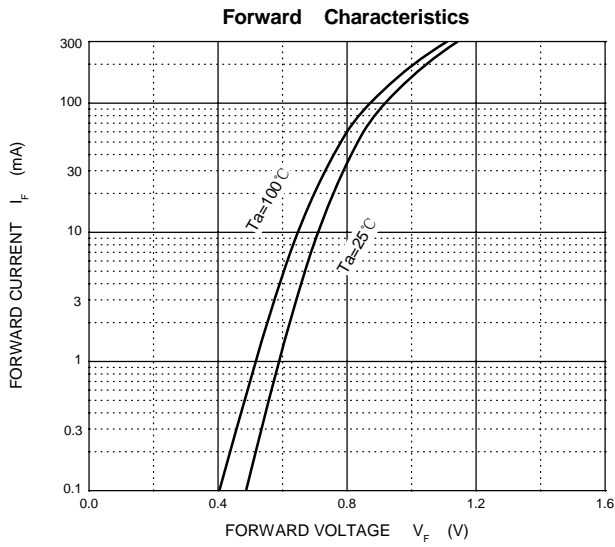

X-ON Electronics

Largest Supplier of Electrical and Electronic Components

Click to view similar products for [Diodes - General Purpose, Power, Switching category:](#)

Click to view products by [Changjiang manufacturer:](#)

Other Similar products are found below :

[MMBD3004S-13-F](#) [RD0306T-H](#) [DSE010-TR-E](#) [BAV17-TR](#) [BAV19-TR](#) [1N3611](#) [NTE156A](#) [NTE574](#) [NTE6244](#) [1SS181-TP](#) [1SS193,LF](#)
[1SS400CST2RA](#) [SDAA13](#) [SHN2D02FUTW1T1G](#) [LS4151GS08](#) [FC903-TR-E](#) [1N4449](#) [1N456A](#) [1N4934-E3/73](#) [1N914B](#) [1N914BTR](#)
[1SS226-TP](#) [RFUH20TB3S](#) [D291S45T](#) [BAV300-TR](#) [BAW56DWQ-7-F](#) [BAW75-TAP](#) [MM230L-CAA](#) [IDW40E65D1](#) [JAN1N3600](#) [LL4151-](#)
[GS18](#) [053684A](#) [SMMSD4148T3G](#) [707803H](#) [NSVDAN222T1G](#) [CDSZC01100-HF](#) [LL4150-M-08](#) [BAV199E6433HTMA1](#) [BAS28-7](#)
[BAW56HDW-13](#) [BAS28 TR](#) [VS-HFA04SD60STR-M3](#) [NSVM1MA152WKT1G](#) [RGP30D-E3/73](#) [BAV99TQ-13-F](#) [BAS21DWA-7](#) [NTE6250](#)
[NTE582-4](#) [NTE582-6](#) [MMDB30-E28X](#)