



SOT-23 Plastic-Encapsulate Transistors

MMBTA14 TRANSISTOR (NPN)

FEATURES

Darlington Amplifier

Marking : K3D

MAXIMUM RATINGS (T_a=25°C unless otherwise noted)

Symbol	Parameter	Value	Unit
V _{CBO}	Collector-Base Voltage	30	V
V _{CEO}	Collector-Emitter Voltage	30	V
V _{EBO}	Emitter-Base Voltage	10	V
I _C	Collector Current -Continuous	0.3	A
P _C	Collector Power Dissipation	300	mW
R _{θJA}	Thermal Resistance from Junction to Ambient	417	°C/W
T _J	Junction Temperature	150	°C
T _{stg}	Storage Temperature	-55~+150	°C

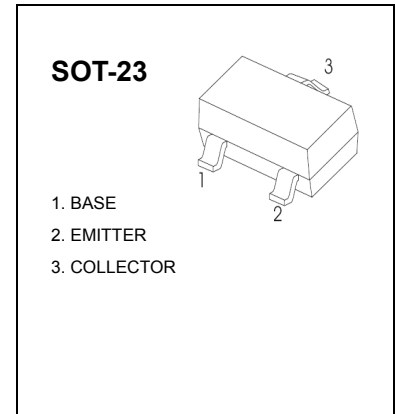

ELECTRICAL CHARACTERISTICS (T_a=25°C unless otherwise specified)

Parameter	Symbol	Test conditions	Min	Max	Unit
Collector-base breakdown voltage	V _{(BR)CBO}	I _C = 100μA, I _E =0	30		V
Collector-emitter breakdown voltage	V _{(BR)CEO}	I _C = 100μA, I _B =0	30		V
Emitter-base breakdown voltage	V _{(BR)EBO}	I _E = 100μA, I _C =0	10		V
Collector cut-off current	I _{CBO} *	V _{CB} =30 V, I _E =0		0.1	μA
Emitter cut-off current	I _{EBO} *	V _{EB} = 10V, I _C =0		0.1	μA
DC current gain	h _{FE(1)} *	V _{CE} =5V, I _C = 10mA	10000		
	h _{FE(2)} *	V _{CE} =5V, I _C = 100mA	20000		
Collector-emitter saturation voltage	V _{CE(sat)} *	I _C =100mA, I _B =0.1mA		1.5	V
Base-emitter saturation voltage	V _{BE(sat)} *	I _C =100mA, I _B =0.1mA		2	V
Base-emitter voltage	V _{BE} *	V _{CE} =5V, I _C = 100mA		2.0	V
Transition frequency	f _T	V _{CE} =5V, I _C = 10mA f=100MHz	125		MHz
Collector output capacitance	C _{ob}	V _{CB} =10V, I _E =0, f=1MHz		12	pF

* Pulse Test : pulse width≤300μs, duty cycles≤2%.

Typical Characteristics

MMBTA14

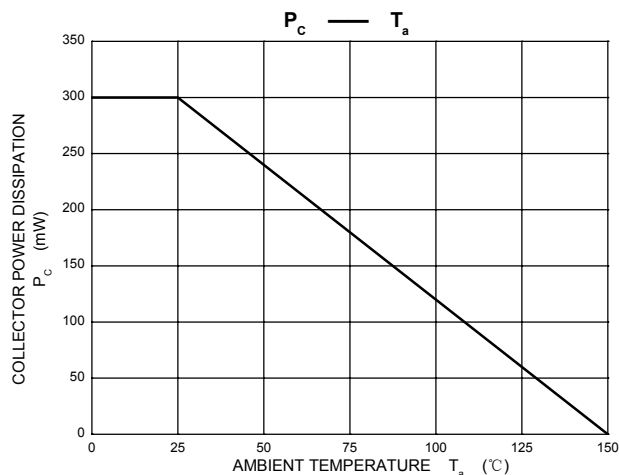
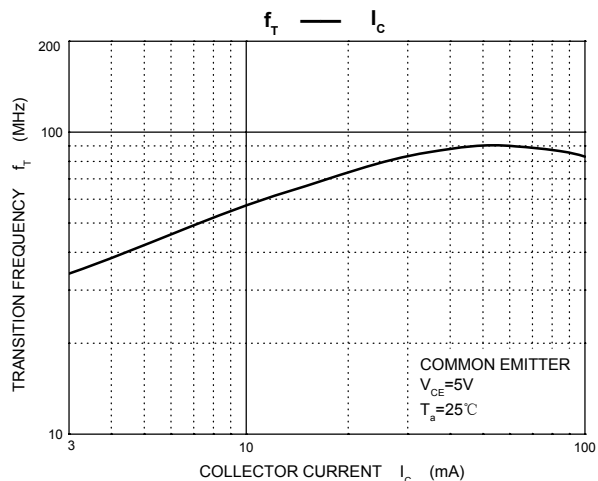
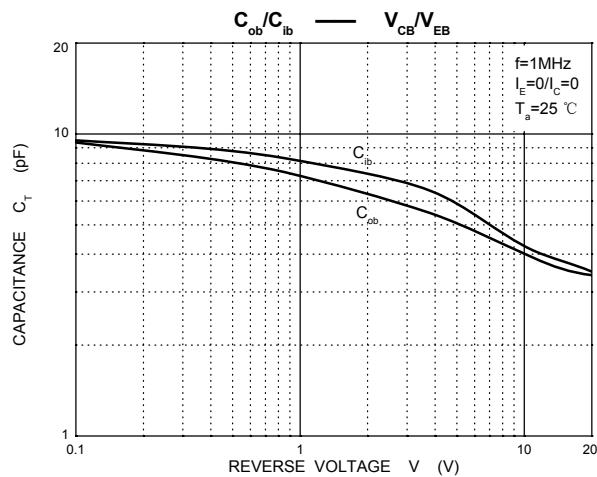
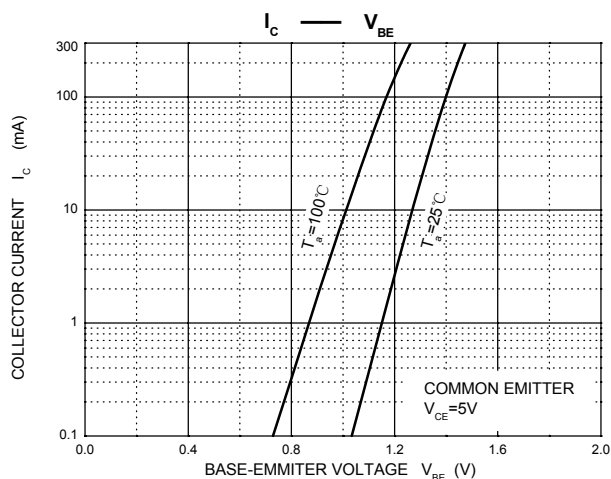
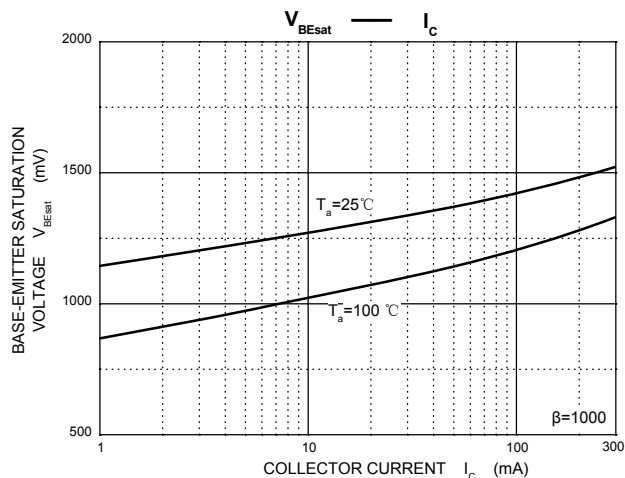
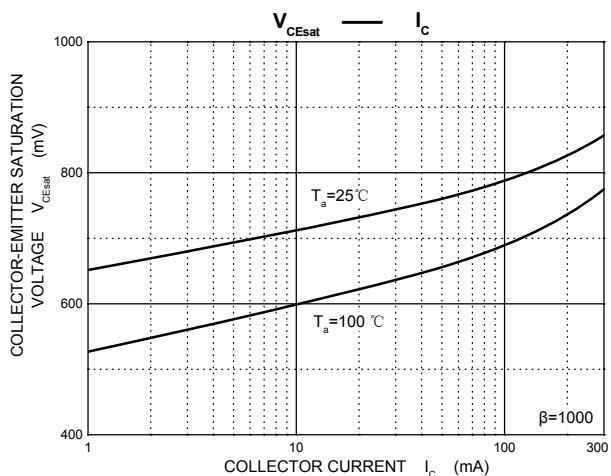
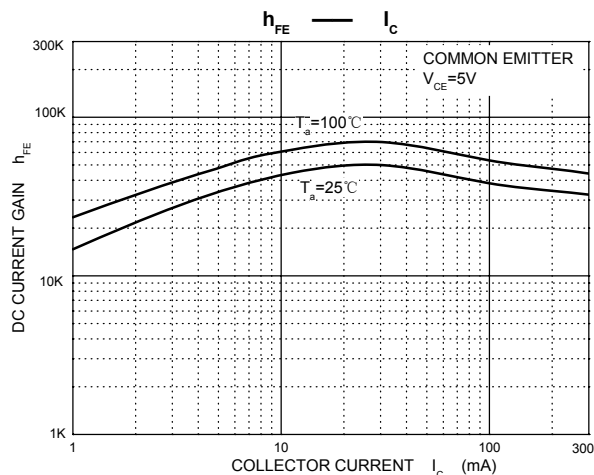
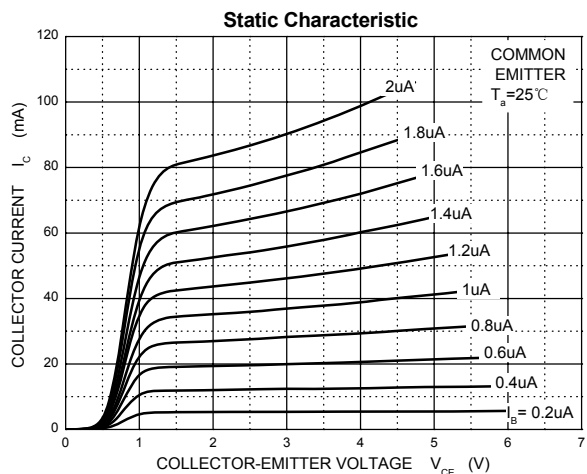

X-ON Electronics

Largest Supplier of Electrical and Electronic Components

Click to view similar products for [Darlington Transistors](#) category:

Click to view products by [Changjiang](#) manufacturer:

Other Similar products are found below :

[281287X](#) [SMMBT6427LT1G](#) [2N7371](#) [BDV64B](#) [JANTXV2N6287](#) [028710A](#) [SMMBTA64LT1G](#) [2N6350](#) [2SB1214-TL-E](#)
[SMMBTA14LT1G](#) [SBSP52T1G](#) [NJVMJD117T4G](#) [Jantx2N6058](#) [2N6353](#) [LB1205-L-E](#) [500-00005](#) [2N6053](#) [NJVMJD112G](#) [Jan2N6350](#)
[Jantx2N6352](#) [Jantx2N6350](#) [BULN2803LVS](#) [ULN2001N](#) [2SB1383](#) [2SB1560](#) [2SB852KT146B](#) [TIP112TU](#) [TIP122TU](#) [BCV27](#) [MMBTA13-](#)
[TP](#) [MMBTA14-TP](#) [MMSTA28T146](#) [BSP50H6327XTSA1](#) [KSH122TF](#) [NTE2557](#) [NJVNJD35N04T4G](#) [TIP115](#) [MPSA29-D26Z](#) [MJD127T4](#)
[FJB102TM](#) [BCV26E6327HTSA1](#) [BCV46E6327HTSA1](#) [BCV47E6327HTSA1](#) [BSP61H6327XTSA1](#) [BU941ZPFI](#) [2SB1316TL](#) [2SD1980TL](#)
[NTE2350](#) [NTE245](#) [NTE246](#)