

SOD-123 Plastic-Encapsulate Diodes

MMSZ4678-MMSZ4717 ZENER DIODE

SOD-123

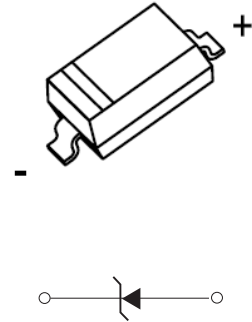

Features

- Pb-Free Packages are Available
- Wide Zener Reverse Voltage Range
- Small Package Size for High Density Applications
- ESD Rating of Class 3 (>16 kV) per Human Body Model

Maximum Ratings (T_a =25°C unless otherwise specified)

| Characteristic | Symbol | Value | Unit |
|---------------------------------------------|------------------|------------|------|
| Forward voltage @I _F =10mA | V _F | 0.9 | V |
| Power Dissipation | P _D | 350 | mW |
| Thermal Resistance, Junction to Ambient Air | R _{θJA} | 357 | °C/W |
| Junction Temperature | T _j | 150 | °C |
| Storage Temperature Range | T _{stg} | -55 ~ +150 | °C |

Notes: Device mounted on ceramic PCB;5.0mm×7.0mm with pad areas 35 mm²

ELECTRICAL CHARACTERISTICS (T_a=25°C unless otherwise noted)

| symbol | Parameter |
|-----------------|------------------------------------------|
| V _Z | Reverse zener voltage @ I _{ZT} |
| I _{ZT} | Reverse current |
| I _R | Reverse leakage current @ V _R |
| V _R | Reverse voltage |
| I _F | Forward current |
| V _F | Forward voltage @ I _F |

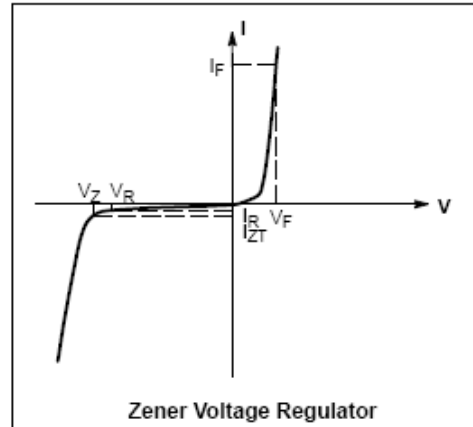

ELECTRICAL CHARACTERISTICS

T_a=25°C unless otherwise specified

| Device | Device Marking | Zener Voltage (Notes 1) | | | | Leakage Current | |
|-----------------|----------------|-------------------------|------------|-------------|-------------------|---------------------------------|----------|
| | | V _Z (Volts) | | | @ I _{ZT} | I _R @ V _R | |
| | | Min | Nom | Max | μA | μA | Volts |
| MMSZ4678 | CC | 1.71 | 1.8 | 1.89 | 50 | 7.5 | 1 |
| MMSZ4679 | CD | 1.90 | 2.0 | 2.10 | 50 | 5 | 1 |
| MMSZ4680 | CE | 2.09 | 2.2 | 2.31 | 50 | 4 | 1 |
| MMSZ4681 | CF | 2.28 | 2.4 | 2.52 | 50 | 2 | 1 |
| MMSZ4682 | CH | 2.565 | 2.7 | 2.835 | 50 | 1 | 1 |
| MMSZ4683 | CJ | 2.85 | 3.0 | 3.15 | 50 | 0.8 | 1 |
| MMSZ4684 | CK | 3.13 | 3.3 | 3.47 | 50 | 7.5 | 1.5 |
| MMSZ4685 | CM | 3.42 | 3.6 | 3.78 | 50 | 7.5 | 2 |
| MMSZ4686 | CN | 3.70 | 3.9 | 4.10 | 50 | 5 | 2 |
| MMSZ4687 | CP | 4.09 | 4.3 | 4.52 | 50 | 4 | 2 |
| MMSZ4688 | CT | 4.47 | 4.7 | 4.94 | 50 | 10 | 3 |
| MMSZ4689 | CU | 4.85 | 5.1 | 5.36 | 50 | 10 | 3 |
| MMSZ4690 | CV | 5.32 | 5.6 | 5.88 | 50 | 10 | 4 |
| MMSZ4691 | CA | 5.89 | 6.2 | 6.51 | 50 | 10 | 5 |
| MMSZ4692 | CX | 6.46 | 6.8 | 7.14 | 50 | 10 | 5.1 |
| MMSZ4693 | CY | 7.13 | 7.5 | 7.88 | 50 | 10 | 5.7 |
| MMSZ4694 | CZ | 7.79 | 8.2 | 8.61 | 50 | 1 | 6.2 |
| MMSZ4695 | DC | 8.27 | 8.7 | 9.14 | 50 | 1 | 6.6 |
| MMSZ4696 | DD | 8.65 | 9.1 | 9.56 | 50 | 1 | 6.9 |
| MMSZ4697 | DE | 9.50 | 10 | 10.50 | 50 | 1 | 7.6 |
| MMSZ4698 | DF | 10.45 | 11 | 11.55 | 50 | 0.05 | 8.4 |
| MMSZ4699 | DH | 11.40 | 12 | 12.60 | 50 | 0.05 | 9.1 |
| MMSZ4700 | DJ | 12.35 | 13 | 13.65 | 50 | 0.05 | 9.8 |
| MMSZ4701 | DK | 13.30 | 14 | 14.70 | 50 | 0.05 | 10.6 |
| MMSZ4702 | DM | 14.25 | 15 | 15.75 | 50 | 0.05 | 11.4 |
| MMSZ4703* | DN | 15.20 | 16 | 16.80 | 50 | 0.05 | 12.1 |
| MMSZ4704 | DP | 16.15 | 17 | 17.85 | 50 | 0.05 | 12.9 |
| MMSZ4705 | DT | 17.10 | 18 | 18.90 | 50 | 0.05 | 13.6 |
| MMSZ4706 | DU | 18.05 | 19 | 19.95 | 50 | 0.05 | 14.4 |
| MMSZ4707 | DV | 19.00 | 20 | 21.00 | 50 | 0.01 | 15.2 |
| MMSZ4708 | DA | 20.90 | 22 | 23.10 | 50 | 0.01 | 16.7 |
| MMSZ4709 | DX | 22.80 | 24 | 25.20 | 50 | 0.01 | 18.2 |
| MMSZ4710 | DY | 23.75 | 25 | 26.25 | 50 | 0.01 | 19.0 |
| MMSZ4711* | EA | 25.65 | 27 | 28.35 | 50 | 0.01 | 20.4 |
| MMSZ4712 | EC | 26.60 | 28 | 29.40 | 50 | 0.01 | 21.2 |
| MMSZ4713 | ED | 28.50 | 30 | 31.50 | 50 | 0.01 | 22.8 |
| MMSZ4714 | EE | 31.35 | 33 | 34.65 | 50 | 0.01 | 25.0 |
| MMSZ4715 | EF | 34.20 | 36 | 37.80 | 50 | 0.01 | 27.3 |
| MMSZ4716 | EH | 37.05 | 39 | 40.95 | 50 | 0.01 | 29.6 |
| MMSZ4717 | EJ | 40.85 | 43 | 45.15 | 50 | 0.01 | 32.6 |

1. Nominal Zener voltage is measured with the device junction in thermal equilibrium at T_L = 30°C ±1°C

SOD-123 Package Outline Dimensions

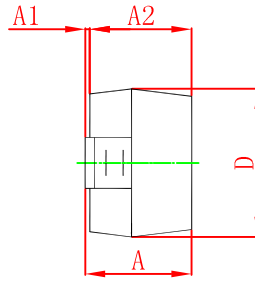
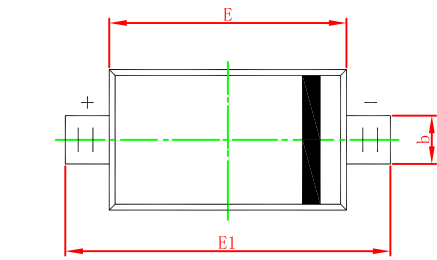

| Symbol | Dimensions In Millimeters | | Dimensions In Inches | |
|----------|---------------------------|-------|----------------------|-------|
| | Min | Max | Min | Max |
| A | 1.050 | 1.250 | 0.041 | 0.049 |
| A1 | 0.000 | 0.100 | 0.000 | 0.004 |
| A2 | 1.050 | 1.150 | 0.041 | 0.045 |
| b | 0.450 | 0.650 | 0.018 | 0.026 |
| c | 0.080 | 0.150 | 0.003 | 0.006 |
| D | 1.500 | 1.700 | 0.059 | 0.067 |
| E | 2.600 | 2.800 | 0.102 | 0.110 |
| E1 | 3.550 | 3.850 | 0.140 | 0.152 |
| L | 0.500 REF | | 0.020 REF | |
| L1 | 0.250 | 0.450 | 0.010 | 0.018 |
| θ | 0° | 8° | 0° | 8° |

SOD-123 Suggested Pad Layout



Note:

1. Controlling dimension: in millimeters.
2. General tolerance: $\pm 0.05\text{mm}$.
3. The pad layout is for reference purposes only.

NOTICE

JCET reserve the right to make modifications, enhancements, improvements, corrections or other changes without further notice to any product herein. JCET does not assume any liability arising out of the application or use of any product described herein.

SOD-123 Tape and Reel

SOD-123 Embossed Carrier Tape

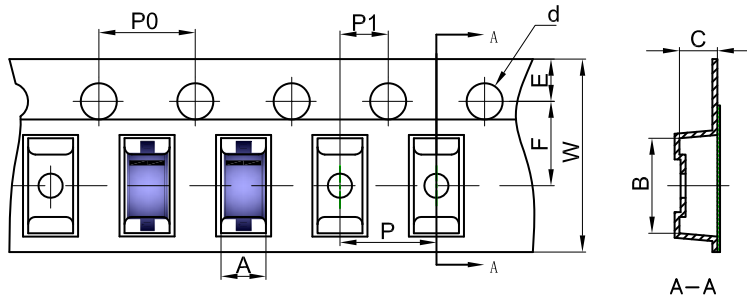

Packaging Description:

SOD-123 parts are shipped in tape. The carrier tape is made from a dissipative (carbon filled) polycarbonate resin. The cover tape is a multilayer film (Heat Activated Adhesive in nature) primarily composed of polyester film, adhesive layer, sealant, and anti-static sprayed agent. These reeled parts in standard option are shipped with 3,000 units per 7" or 17.8cm diameter reel. The reels are clear in color and is made of polystyrene plastic (anti-static coated).

Dimensions are in millimeter

| Pkg type | A | B | C | d | E | F | P0 | P | P1 | W |
|----------|------|------|------|-------|------|------|------|------|------|------|
| SOD-123 | 1.85 | 3.95 | 1.57 | Ø1.55 | 1.75 | 3.50 | 4.00 | 4.00 | 2.00 | 8.00 |

SOD-123 Tape Leader and Trailer

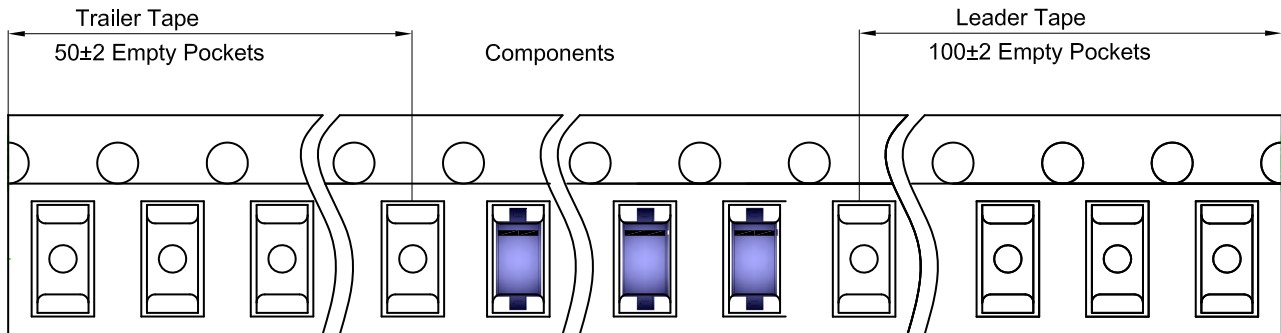

SOD-123 Reel

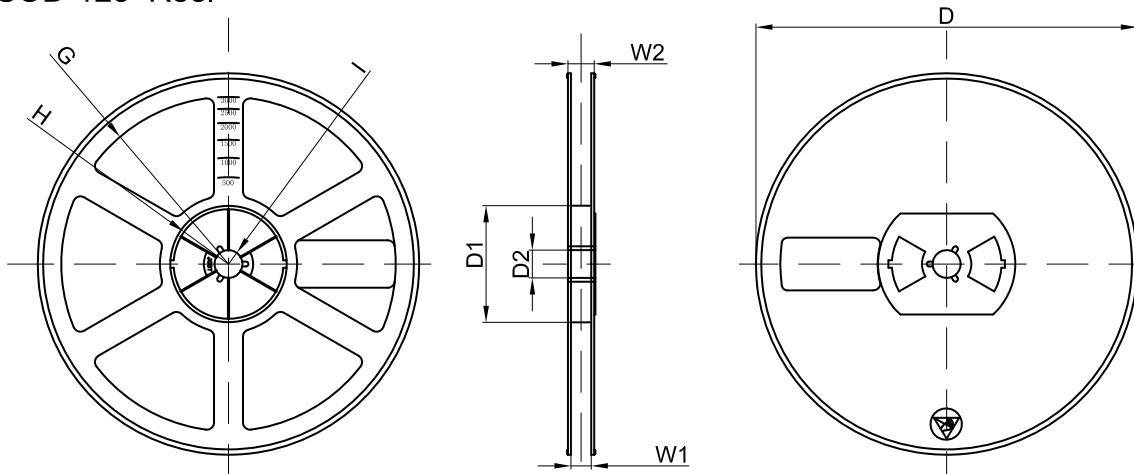

Dimensions are in millimeter

| Reel Option | D | D1 | D2 | G | H | I | W1 | W2 |
|-------------|---------|-------|-------|--------|--------|-------|------|-------|
| 7" Dia | Ø178.00 | 54.40 | 13.00 | R78.00 | R25.60 | R6.50 | 9.50 | 12.30 |

| REEL | Reel Size | Box | Box Size(mm) | Carton | Carton Size(mm) | G.W.(kg) |
|----------|-----------|------------|--------------|-------------|-----------------|----------|
| 3000 pcs | 7 inch | 45,000 pcs | 203×203×195 | 180,000 pcs | 438×438×220 | |

X-ON Electronics

Largest Supplier of Electrical and Electronic Components

Click to view similar products for [Zener Diodes](#) category:

Click to view products by [Changjiang](#) manufacturer:

Other Similar products are found below :

[RKZ13B2KG#P1](#) [DL5234B](#) [EDZTE6113B](#) [1N4682](#) [1N4691](#) [1N4693](#) [1N4732A](#) [1N4736A](#) [1N4750A](#) [1N4759ARL](#) [1N5241B](#) [1N5365B](#)
[1N5369B](#) [1N747A](#) [1N959B](#) [1N964B](#) [1N966B](#) [1N968B](#) [1N972B](#) [NTE5121A](#) [NTE5147A](#) [NTE5152A](#) [NTE5155A](#) [NTE5164A](#)
[JANS1N4974US](#) [1N4692](#) [1N4700](#) [1N4702](#) [1N4704](#) [1N4711](#) [1N4714](#) [1N4737A](#) [1N4745ARL](#) [1N4752A](#) [1N4752ARL](#) [1N4760ARL](#)
[1N5221B](#) [1N5236B](#) [1N5241BTR](#) [1N5242BTR](#) [1N5350B](#) [1N5352B](#) [1N961BRR1](#) [1N964BRL](#) [RKZ5.1BKU#P6](#) [3SMAJ5946B-TP](#)
[3SMAJ5950B-TP](#) [3SMBJ5925B-TP](#) [441774C](#) [BZX84C3V9](#)