

Specification for Approval

Customer	
Product Name	Wire Wound Molded SMD Power Inductors
Customer P/N:	
Cjiang P/N:	FAUL Series

[New Released, Revised]

SPEC No.:

REMARK:		
Customer Approval Feedback		

● 深圳市长江微电科技有限公司
 SZ CJIANG TECHNOLOGY CO.,LTD
 ADD: 11F, International Science and Technology Building, Fuhong Road, Futian District, Shenzhen
 Factory ADD:No. shanyang RD CJIANG Industrial Park HUIAi'AN Section HUIAi'AN City Jiangsu Province
 TEL: 0755-82529562 FAX:0755-83977004
<http://www.CJING.COM.CN>
 E-mail: BOND@cjiang.com.cn; ann@cjiang.com.cn

Version change history

Rev	Date	Description	APPROVED	CHECKED	DRAWN
1.0	2022/8/9	文件制定	Bond	Charles	王云燕

Introduction

- ROHS, Halogen Free and REACH compliance
- High rated current
- Low core loss
- Ultra low buzz noise due to molding construction
- AEC-Q200 qualified



AEC-Q200



Electrical Characteristics

Operating temperature range (Including self-heating): $-55^{\circ}\text{C} \sim +155^{\circ}\text{C}$.

Storage temperature and humidity range (product with tapping): $-10^{\circ}\text{C} \sim +40^{\circ}\text{C}$, RH 70% Max

Applications

- Automotive applications

Product Identification

FAUL 1040 -1R5 MT
① ② ③ ④

- ① FAUL ----- Series name
- ② 1040 ----- Dimension
- ③ 1R5 ----- Inductance Value (1R5 = $1.5\mu\text{H}$)
- ④ M ----- Inductance Tolerance (M= $\pm 20\%$)

Dimension-mm



Series	A	B	C	D	E	I Typ.	J Typ.	H Typ.
FAUL0412	4.2±0.25	4.4±0.35	1.0±0.2	0.8±0.3	2.0±0.3	1.5	2.2	2.5
FAUL0420	4.2±0.25	4.4±0.35	1.8±0.2	0.8±0.3	2.0±0.3	1.5	2.2	2.5
FAUL0518	5.2±0.2	5.4±0.35	1.6±0.2	1.20±0.2	2.2±0.3	1.9	2.2	2.5
FAUL0530	5.2±0.2	5.4±0.35	2.8±0.2	1.20±0.2	2.2±0.3	1.9	2.2	2.5
FAUL0618	6.6±0.2	7.0±0.3	1.6±0.2	1.60±0.3	3.0±0.3	2.35	3.7	3.5
FAUL0620	6.6±0.2	7.0±0.3	1.8±0.2	1.60±0.3	3.0±0.3	2.35	3.7	3.5
FAUL0624	6.6±0.2	7.0±0.3	2.2±0.2	1.60±0.3	3.0±0.3	2.35	3.7	3.5
FAUL0630	6.6±0.2	7.0±0.3	2.8±0.2	1.60±0.3	3.0±0.3	2.35	3.7	3.5
FAUL0640	6.6±0.2	7.0±0.3	3.8±0.2	1.60±0.3	3.0±0.3	2.35	3.7	3.5
FAUL0650	6.6±0.2	7.0±0.3	4.8±0.2	1.60±0.3	3.0±0.3	2.35	3.7	3.5
FAUL0754	7.2±0.2	7.9±0.3	5.2±0.2	2.0±0.3	3.0±0.3	3.2	2.6	3.5
FAUL1030	10.0±0.3	11.5 Max	2.8±0.2	2.0±0.5	3.0±0.3	4.1	5.4	4.1
FAUL1040	10.0±0.3	11.0±0.5	3.8±0.2	2.0±0.5	3.0±0.5	4.1	5.4	4.1
FAUL1050	10.0±0.3	11.5 Max	4.8±0.2	2.0±0.5	3.0±0.5	4.1	5.4	4.1
FAUL1340	12.8±0.5	13.45±0.35	4.0Max.	2.0±0.5	See Remarks	3.25	8.0	5.5
FAUL1350	12.6±0.3	13.45±0.35	4.8±0.2	2.0±0.5	See Remarks	3.25	8.0	5.5
FAUL1360	12.6±0.3	13.45±0.35	5.8±0.2	2.0±0.5	See Remarks	3.25	8.0	5.5
FAUL1365	12.6±0.3	13.45±0.35	6.5Max.	2.0±0.5	5.0±0.3	3.25	8.0	5.5
FAUL1770	17.15Max	17.15±0.35	7.0Max	2.5±0.5	12.0±0.3	3.50	11.2	12.8

Remarks:

Series	E(mm)	Dimensions
FAUL1340	3.85±0.5	R22/R47
	5.0±0.3	R68/R82/1R0/1R5/2R2/3R3/4R7/6R8/ 100/150/220
FAUL1350	3.85±0.5	R22/R36/R50/R68/R82/ 1R0/ 1R5/2R2
	5.0±0.3	3R3/4R7/6R8/100/ 150/220/330/470
FAUL1360	3.85±0.5	1R5/2R2
	5.0±0.3	3R3/4R7/5R6/6R8/8R2/ 100/ 120/150/ 180/220/270/330/470/680/ 101/121/ 151

Marking

The inductor is marked with a 3-digit code

Nominal Inductance	
Example	Nominal Value
1R0	1.0 μH
100	10 μH
101	100 μH

Note : Using Ink for marking



Structure and Components

Symbol	Components	Material
a	MARKING	Ink(black)
b	CORE	Alloy Sponge Powder
c	WIRE	Polyurethane copper wire
d	Terminal	Copper plated with Sn



Appendix A: Electrical Characteristics

FAUL0412-XXX Series

Part Number	Inductance	DC Resistance	Saturation Current *3		Heat Rating Current ⁴	
	@100KHZ,1V	Max.	Max.	Typ.	Max.	Typ.
Units	uH	mΩ	A		A	
Symbol	L	DCR	Isat		Irms	
FAUL0412-R15MT	0.15±20%	9	12.00	15.00	6.80	7.50
FAUL0412-R22MT	0.22±20%	11	8.80	11.00	6.50	7.00
FAUL0412-R33MT	0.33±20%	19	6.70	8.40	5.70	6.50
FAUL0412-R47MT	0.47±20%	21	5.40	6.80	5.20	6.00
FAUL0412-R68MT	0.68±20%	36	4.80	6.00	4.20	4.70
FAUL0412-1R0MT	1.0±20%	47	4.40	5.50	3.80	4.50
FAUL0412-1R5MT	1.5±20%	75	3.20	4.00	2.70	3.25
FAUL0412-2R2MT	2.2±20%	83.5	2.40	3.00	2.20	2.75
FAUL0412-3R3MT	3.3±20%	160	2.38	2.7	1.77	2.00
FAUL0412-4R7MT	4.7±20%	195	1.80	2.20	1.45	1.80

FAUL0420 -XXX Series

Part Number	Inductance	DC Resistance	Saturation Current *3		Heat Rating Current ⁴	
	@100KHZ,1V	Max.	Max.	Typ.	Max.	Typ.
Units	uH	mΩ	A		A	
Symbol	L	DCR	Isat		Irms	
FAUL0420-R10MT	0.10±20%	4	17.60	22.00	11.20	13.00
FAUL0420-R22MT	0.22±20%	6.6	10.00	12.50	8.20	9.50
FAUL0420-R33MT	0.33±20%	11	9.60	12.00	8.60	10.00
FAUL0420-R47MT	0.47±20%	14	7.60	9.50	6.65	7.50
FAUL0420-R56MT	0.56±20%	16	7.20	9.00	6.10	7.00

FAUL0420-R68MT	0.68±20%	18	6.40	8.00	6.15	7.00
FAUL0420-1R0MT	1.0±20%	27	5.60	7.00	5.40	6.00
FAUL0420-1R2MT	1.2±20%	27	5.20	6.50	5.40	6.00
FAUL0420-1R5MT	1.5±20%	46	4.40	5.50	4.30	5.00
FAUL0420-2R2MT	2.2±20%	58	4.00	5.00	3.80	4.50
FAUL0420-3R3MT	3.3±20%	87	2.80	3.50	2.80	3.30
FAUL0420-4R7MT	4.7±20%	105	2.40	3.00	2.20	2.80
FAUL0420-6R8MT	6.8±20%	175	2.00	2.50	1.90	2.40
FAUL0420-100MT	10±20%	282	1.60	2.00	1.30	1.60
FAUL0420-220MT	22±20%	363	1.12	1.40	0.90	1.20

FAUL0518 -XXX Series

Part Number	Inductance	DC Resistance	Saturation Current ^{*3}		Heat Rating Current ^{*4}	
	@100KHZ, 1V	Max.	Max.	Typ.	Max.	Typ.
Units	uH	mΩ	A		A	
Symbol	L	DCR	Isat		Irms	
FAUL0518-R47MT	0.47±20%	9	9.60	12.00	9.50	10.50
FAUL0518-R56MT	0.56±20%	10	8.80	11.00	8.20	9.50
FAUL0518-1R0MT	1.0±20%	17	7.20	9.00	7.20	8.00
FAUL0518-1R5MT	1.5±20%	26	6.40	8.00	6.60	7.50
FAUL0518-2R2MT	2.2±20%	35	4.80	6.00	4.20	5.00
FAUL0518-3R3MT	3.3±20%	58	3.84	4.80	3.80	4.50
FAUL0518-4R7MT	4.7±20%	85	3.20	4.00	3.00	3.50
FAUL0518-6R8MT	6.8±20%	120	2.72	3.40	2.40	2.80
FAUL0518-100MT	10±20%	155	2.00	2.50	2.20	2.50

FAUL0530 -XXX Series

Part Number	Inductance	DC Resistance	Saturation Current ³		Heat Rating Current ⁴	
	@100KHZ,1V	Max.	Max.	Typ.	Max.	Typ.
Units	uH	mΩ	A		A	
Symbol	L	DCR	Isat		Irms	
FAUL0530-R10MT	0.10±20%	3.0	24.00	30.00	23.00	25.00
FAUL0530-R20MT	0.20±20%	3.9	16.00	20.00	13.00	14.00
FAUL0530-R33MT	0.33±20%	5.5	14.40	18.00	13.10	14.00
FAUL0530-R47MT	0.47±20%	8.5	12.00	15.00	10.00	11.00
FAUL0530-R68MT	0.68±20%	12	9.20	11.50	8.20	9.00
FAUL0530-R82MT	0.82±20%	10.4	9.20	10.50	9.0	10.5
FAUL0530-1R0MT	1.0±20%	14	8.00	10.00	7.80	8.50
FAUL0530-1R2MT	1.2±20%	16	7.60	9.50	7.85	8.50
FAUL0530-1R5MT	1.5±20%	25	7.20	9.00	7.60	8.20
FAUL0530-2R2MT	2.2±20%	29	5.60	7.00	6.40	7.00
FAUL0530-3R3MT	3.3±20%	38	4.80	6.00	5.00	5.50
FAUL0530-4R7MT	4.7±20%	60	3.68	4.60	4.00	4.50
FAUL0530-6R8MT	6.8±20%	90	2.88	3.60	2.90	3.50
FAUL0530-100MT	10±20%	125	2.80	3.50	2.80	3.20
FAUL0530-150MT	15±20%	170	2.00	2.20	1.60	1.80

FAUL0618 -XXX Series

Part Number	Inductance	DC Resistance	Saturation Current ³		Heat Rating Current ⁴	
	@100KHZ,1V	Max.	Max.	Typ.	Max.	Typ.
Units	uH	mΩ	A		A	
Symbol	L	DCR	Isat		Irms	
FAUL0618-R10MT	0.10±20%	2.3	30.40	38.00	23.00	25.00
FAUL0618-R22MT	0.22±20%	3.5	19.20	24.00	20.00	22.00

FAUL0618-R47MT	0.47±20%	8.4	14.40	18.00	10.00	11.50
FAUL0618-R68MT	0.68±20%	12	13.20	16.50	8.40	9.50
FAUL0618-1R0MT	1.0±20%	16	9.60	12.00	7.60	8.50
FAUL0618-1R5MT	1.5±20%	26	7.36	9.20	7.10	8.00
FAUL0618-2R2MT	2.2±20%	35	6.40	8.00	6.20	7.00
FAUL0618-3R3MT	3.3±20%	50	4.80	6.00	3.80	4.50
FAUL0618-4R7MT	4.7±20%	62	4.00	5.00	3.50	4.00
FAUL0618-6R8MT	6.8±20%	110	3.60	4.50	2.40	3.00
FAUL0618-8R2MT	8.2±20%	135	2.90	3.60	2.10	2.40
FAUL0618-100MT	10±20%	155	3.20	4.00	1.95	2.30
FAUL0618-220MT	22±20%	350	1.84	2.30	1.40	1.80

FAUL0620-XXX Series

Part Number	Inductance	DC Resistance	Saturation Current ^{*3}		Heat Rating Current ^{*4}	
	@100KHZ,1V	Max.	Max.	Typ.	Max.	Typ.
Units	uH	mΩ	A		A	
Symbol	L	DCR	Isat		Irms	
FAUL0620-1R5MT	1.5±20%	18	10	12	7.0	8.0
FAUL0620-4R7MT	4.7±20%	60	-	5.5	-	4.3
FAUL0620-100MT	10±20%	145	-	4.0	-	2.8

FAUL0624 -XXX Series

Part Number	Inductance	DC Resistance	Saturation Current ^{*3}		Heat Rating Current ^{*4}	
	@100KHZ,1V	Max.	Max.	Typ.	Max.	Typ.
Units	uH	mΩ	A		A	
Symbol	L	DCR	Isat		Irms	
FAUL0624-R22MT	0.22±20%	3	24.00	30.00	19.00	21.00

FAUL0624-R33MT	0.33±20%	4.1	19.60	24.50	16.00	18.00
FAUL0624-R47MT	0.47±20%	5.1	16.00	20.00	13.50	15.00
FAUL0624-R56MT	0.56±20%	6.5	13.60	17.00	11.50	13.00
FAUL0624-R68MT	0.68±20%	7	12.80	16.00	10.50	12.00
FAUL0624-1R0MT	1.0±20%	13.5	12.00	15.00	8.00	9.00
FAUL0624-1R5MT	1.5±20%	20	10.80	13.50	7.00	8.20
FAUL0624-2R2MT	2.2±20%	28	8.00	10.00	6.20	7.00
FAUL0624-3R3MT	3.3±20%	39	6.40	8.00	4.80	5.50
FAUL0624-4R7MT	4.7±20%	50	5.20	6.50	4.30	5.00
FAUL0624-6R8MT	6.8±20%	70	4.80	6.00	3.20	4.00
FAUL0624-100MT	10±20%	101	3.20	4.00	2.40	3.10
FAUL0624-150MT	15±20%	160	2.64	3.30	2.00	2.50
FAUL0624-220MT	22±20%	230	2.00	2.50	1.60	2.00

FAUL0630 -XXX Series

Part Number	Inductance	DC Resistance	Saturation Current ³		Heat Rating Current ⁴	
	@100KHZ,1V	Max.	Max.	Typ.	Max.	Typ.
Units	uH	mΩ	A		A	
Symbol	L	DCR	Isat		Irms	
FAUL0630-R22MT	0.22±20%	3	27.20	34.00	21.00	24.00
FAUL0630-R24MT	0.24±20%	3.1	22.40	28.00	18.40	23.00
FAUL0630-R33MT	0.33±20%	3.5	20.00	25.00	19.00	21.00
FAUL0630-R47MT	0.47±20%	4.1	16.00	20.00	16.50	18.00
FAUL0630-R56MT	0.56±20%	4.5	14.40	18.00	15.00	16.50
FAUL0630-R68MT	0.68±20%	5.3	13.60	17.00	14.50	16.00
FAUL0630-R82MT	0.82±20%	6.0	12.80	16.00	12.50	14.00

FAUL0630-1R0MT	1.0±20%	7.4	12.00	15.00	10.50	12.00
FAUL0630-1R5MT	1.5±20%	12.1	9.60	12.00	10.50	12.00
FAUL0630-1R8MT	1.8±20%	15	14.0	15.5	8.7	9.5
FAUL0630-2R2MT	2.2±20%	15	8.00	10.00	8.50	9.50
FAUL0630-3R3MT	3.3±20%	22	7.60	9.50	7.50	8.50
FAUL0630-4R7MT	4.7±20%	33	7.20	9.00	5.00	6.00
FAUL0630-5R6MT	5.6±20%	42	5.20	6.50	4.80	5.50
FAUL0630-6R8MT	6.8±20%	48	4.80	6.00	4.20	5.00
FAUL0630-8R2MT	8.2±20%	60	4.40	5.50	4.20	5.00
FAUL0630-100MT	10±20%	68	4.40	5.50	3.80	4.50
FAUL0630-150MT	15±20%	113	3.20	4.00	2.30	3.00
FAUL0630-220MT	22±20%	170	2.40	3.00	2.00	2.50
FAUL0630-330MT	33±20%	270	2.00	2.50	1.60	2.00
FAUL0630-470MT	47±20%	385	1.60	2.00	1.20	1.50

FAUL0640 -XXX Series

Part Number	Inductance	DC Resistance	Saturation Current ^{*3}		Heat Rating Current ^{*4}	
	@100KHZ,1V	Max.	Max.	Typ.	Max.	Typ.
Units	uH	mΩ	A		A	
Symbol	L	DCR	Isat		Irms	
FAUL0640-R68MT	0.68±20%	4.8	15.0	19.0	13.6	17.0
FAUL0640-1R0MT	1.0±20%	6.6	12.6	16.0	10.8	13.5
FAUL0640-1R5MT	1.5±20%	10	10	12.5	9.92	12.4
FAUL0640-2R2MT	2.2±20%	14	8.80	11.00	7.80	10.0
FAUL0640-3R3MT	3.3±20%	20	7.6	9.5	6.8	8.5
FAUL0640-4R7MT	4.7±20%	30	7.20	9.00	6.00	6.50
FAUL0640-6R8MT	6.8±20%	45	5.2	6.5	4.5	5.5
FAUL0640-100MT	10±20%	65	4.8	6.0	4	4.8

FAUL0640-150MT	15±20%	95	3.60	4.50	2.80	3.70
FAUL0640-220MT	22±20%	125	3.2	4.0	2.7	3.3
FAUL0640-330MT	33±20%	240	2.4	3.0	1.8	2.2
FAUL0640-470MT	47±20%	320	2	2.5	1.5	1.8

FAUL0650 -XXX Series

Part Number	Inductance	DC Resistance	Saturation Current ³		Heat Rating Current ⁴	
	@100KHZ,1V	Max.	Max.	Typ.	Max.	Typ.
Units	uH	mΩ	A		A	
Symbol	L	DCR	Isat		Irms	
FAUL0650-R47MT	0.47±20%	3.9	16.80	21.00	17.00	20.00
FAUL0650-R68MT	0.68±20%	4.5	14.40	18.00	14.50	16.50
FAUL0650-1R0MT	1.0±20%	6.6	12.80	16.00	10.00	12.00
FAUL0650-1R5MT	1.5±20%	10	10.40	13.00	8.20	9.50
FAUL0650-2R2MT	2.2±20%	12.5	8.80	11.00	8.00	9.00
FAUL0650-3R3MT	3.3±20%	22	8.00	10.00	7.60	8.50
FAUL0650-4R7MT	4.7±20%	29	6.40	8.00	5.00	6.00
FAUL0650-6R8MT	6.8±20%	41	5.04	6.30	4.00	5.80
FAUL0650-8R2MT	8.2±20%	48	4.40	5.50	4.80	5.50
FAUL0650-100MT	10±20%	60	4.24	5.30	3.80	4.50
FAUL0650-150MT	15±20%	90	3.20	4.00	2.60	3.10
FAUL0650-220MT	22±20%	140	2.80	3.50	2.00	2.60
FAUL0650-330MT	33±20%	190	2.40	3.00	1.80	2.30
FAUL0650-470MT	47±20%	230	2.08	2.60	1.50	2.00

FAUL0754- XXX Series

Part Number	Inductance	DC Resistance	Saturation Current ^{*3}		Heat Rating Current ^{*4}	
	@100KHZ,1V	Max.	Max.	Typ.	Max.	Typ.
Units	uH	mΩ	A		A	
Symbol	L	DCR	Isat		Irms	
FAUL0754-1R5MT	1.5±20%	7.3	14.00	16.30	10.30	11.40
FAUL0754-2R2MT	2.2 ± 20%	11.4	12.70	14.80	8.70	9.70
FAUL0754-3R3MT	3.3 ±20%	15.4	11.60	13.50	7.20	8.00
FAUL0754-4R7MT	4.7 ±20%	20.9	11.20	13.10	6.30	7.00
FAUL0754-6R8MT	6.8 ±20%	26.6	8.70	10.20	5.50	6.10
FAUL0754-8R2MT	8.2 ±20%	31.9	7.70	9.00	5.00	5.60
FAUL0754- 100MT	10± 20%	38	6.90	8.00	4.70	5.20
FAUL0754- 150MT	15± 20%	66	5.90	6.90	3.40	3.80
FAUL0754-220MT	22± 20%	93.5	5.40	6.30	3.00	3.30
FAUL0754-330MT	33±20%	127.6	4.20	4.90	2.80	3.20
FAUL0754-470MT	47±20%	171.6	3.50	4.10	2.20	2.40
FAUL0754-560MT	56±20%	209.3	2.80	3.30	2.00	2.20
FAUL0754-680MT	68±20%	255	2.40	2.80	1.80	2.00
FAUL0754- 101MT	100±20%	348	2.00	2.40	1.60	1.80

FAUL1030 -XXX Series

Part Number	Inductance	DC Resistance	Saturation Current ^{*3}		Heat Rating Current ^{*4}	
	@100KHZ,1V	Max.	Max.	Typ.	Max.	Typ.
Units	uH	mΩ	A		A	
Symbol	L	DCR	Isat		Irms	
FAUL1030-R22MT	0.22±20%	1.2	44.24	50.00	29.20	33.00
FAUL1030-R33MT	0.33±20%	1.6	28.30	32.00	20.35	23.00

FAUL1030-R36MT	0.36±20%	1.6	24.80	28.00	20.35	23.00
FAUL1030-R47MT	0.47±20%	2.5	23.00	26.00	19.47	22.00
FAUL1030-R82MT	0.82±20%	3.7	20.35	23.00	15.93	18.00
FAUL1030-1R0MT	1.0±20%	6.0	18.58	21.00	13.27	15.00
FAUL1030-1R5MT	1.5±20%	7.5	17.69	20.00	11.50	13.00
FAUL1030-2R2MT	2.2±20%	9.0	12.38	14.00	9.73	11.00
FAUL1030-3R3MT	3.3±20%	16.0	10.61	12.00	7.96	9.00
FAUL1030-4R7MT	4.7±20%	22.5	8.84	10.00	6.19	7.00
FAUL1030-8R2MT	8.2±20%	45.0	6.20	7.00	4.42	5.00
FAUL1030-100MT	10±20%	55.0	5.75	6.50	3.98	4.50
FAUL1030-330MT	33±20%	160.0	3.53	4.00	2.30	2.60

FAUL1040 -XXX Serie

Part Number	Inductance	DC Resistance	Saturation Current ³		Heat Rating Current ⁴	
	@100KHZ,1V	Max.	Max.	Typ.	Max.	Typ.
Units	uH	mΩ	A		A	
Symbol	L	DCR	Isat		Irms	
FAUL1040-R15MT	0.15±20%	0.65	60.00	75.00	40.00	45.00
FAUL1040-R22MT	0.22±20%	1	48.00	60.00	30.00	35.00
FAUL1040-R30MT	0.30±20%	1.1	36.00	45.00	30.00	35.00
FAUL1040-R36MT	0.36±20%	1.2	36.00	45.00	25.00	30.00
FAUL1040-R45MT	0.45±20%	1.5	34.00	43.00	25.00	30.00
FAUL1040-R47MT	0.47±20%	1.7	32.00	40.00	25.00	30.00
FAUL1040-R56MT	0.56±20%	1.8	26.40	33.00	20.00	25.00
FAUL1040-R68MT	0.68±20%	2.4	24.00	30.00	19.00	23.00
FAUL1040-R80MT	0.80±20%	2.7	23.20	29.00	19.00	23.00
FAUL1040-1R0MT	1.0±20%	3.3	22.40	28.00	16.00	19.00

FAUL1040-1R5MT	1.5±20%	4.2	19.20	24.00	14.00	16.00
FAUL1040-2R2MT	2.2±20%	7	13.20	16.50	10.00	12.00
FAUL1040-3R3MT	3.3±20%	11.8	12.80	16.00	9.50	11.00
FAUL1040-4R7MT	4.7±20%	20	10.40	13.00	7.50	9.00
FAUL1040-6R8MT	6.8±20%	25	9.60	12.00	7.00	8.50
FAUL1040-8R2MT	8.2±20%	27	7.20	9.00	6.80	8.00
FAUL1040-100MT	10±20%	30	6.80	8.50	6.90	7.80
FAUL1040-150MT	15±20%	45	5.60	7.00	5.60	6.50
FAUL1040-220MT	22±20%	66	4.40	5.50	4.20	5.00
FAUL1040-330MT	33±20%	92	3.84	4.80	3.80	4.40
FAUL1040-470MT	47±20%	145	3.10	3.50	2.80	3.30
FAUL1040-680MT	68±20%	195	2.40	3.00	2.00	2.50
FAUL1040-820MT	82±20%	285	2.3	2.8	2.1	2.3
FAUL1040-101MT	100±20%	340	2.1	2.3	1.8	2

FAUL1050-XXX Series

Part Number	Inductance	DC Resistance	Saturation Current ^{*3}		Heat Rating Current ^{*4}	
	@100KHZ,1V	Max.	Max.	Typ.	Max.	Typ.
Units	uH	mΩ	A		A	
Symbol	L	DCR	Isat		Irms	
FAUL1050-R22MT	0.22±20%	0.8	57.5	65	32.5	37
FAUL1050-1R0MT	1.0±20%	3.0	28.0	30	20.3	23
FAUL1050-1R5MT	1.5±20%	3.8	22.0	25	18.5	21
FAUL1050-2R2MT	2.2±20%	6.0	16.8	19	13.2	15
FAUL1050-3R3MT	3.3±20%	10	14.0	16	11.5	13
FAUL1050-4R7MT	4.7±20%	14	13.2	15	9.7	11
FAUL1050-5R6MT	5.6±20%	17	12.3	14	8.5	9.5

FAUL1050-6R8MT	6.8±20%	18.5	12.3	14	8.0	9.0
FAUL1050-100MT	10±20%	28	8.8	10	7.0	8.0
FAUL1050-150MT	15±20%	42	6.5	7.5	5.7	6.5
FAUL1050-220MT	22±20%	50	5.3	6.0	5.0	5.5
FAUL1050-330MT	33±20%	86	4.6	5.2	4.2	4.8
FAUL1050-470MT	47±20%	127	4.0	4.5	3.2	3.7
FAUL1050-101MT	100±20%	290	2.5	2.8	1.8	2.1

FAUL1340-XXX Series

Part Number	Inductance	DC Resistance	Saturation Current ³		Heat Rating Current ⁴	
	@100KHZ,1V	Max.	Max.	Typ.	Max.	Typ.
Units	uH	mΩ	A		A	
Symbol	L	DCR	Isat		Irms	
FAUL1340-R22MT	0.22±20%	0.9	40.00	50.00	38.00	42.00
FAUL1340-R47MT	0.47±20%	2.0	38.40	48.00	29.00	33.00
FAUL1340-R68MT	0.68±20%	3.5	37.60	47.00	24.00	28.00
FAUL1340-R82MT	0.82±20%	4.5	32.00	40.00	24.00	28.00
FAUL1340-1R0MT	1.0±20%	7.5	28.00	35.00	20.00	24.00
FAUL1340-1R5MT	1.5±20%	9.5	24.40	30.50	17.00	20.00
FAUL1340-2R2MT	2.2±20%	11.5	20.80	26.00	15.00	18.00
FAUL1340-3R3MT	3.3±20%	13.0	16.80	21.00	13.00	15.00
FAUL1340-4R7MT	4.7±20%	14.5	14.40	18.00	11.00	13.00
FAUL1340-6R8MT	6.8±20%	20.0	11.20	14.00	8.00	9.00
FAUL1340-100MT	10±20%	25.0	8.00	10.00	7.00	8.00
FAUL1340-150MT	15±20%	39.0	6.00	7.50	5.80	6.50
FAUL1340-220MT	22±20%	51.0	4.80	6.00	3.80	4.50

FAUL1350-XXX Series

Part Number	Inductance	DC Resistance	Saturation Current ³		Heat Rating Current ⁴	
	@100KHZ,1V	Max.	Max.	Typ.	Max.	Typ.
Units	uH	mΩ	A		A	
Symbol	L	DCR	Isat		Irms	
FAUL1350-R22MT	0.22±20%	0.7	60.00	75.00	45.00	50.00
FAUL1350-R36MT	0.36±20%	0.85	40.00	50.00	37.00	42.00
FAUL1350-R50MT	0.50±20%	1.15	38.40	48.00	33.00	38.00
FAUL1350-R68MT	0.68±20%	1.55	36.80	46.00	29.00	33.00
FAUL1350-R82MT	0.82±20%	1.67	31.20	39.00	26.00	30.00
FAUL1350-1R0MT	1.0±20%	2.2	28.00	35.00	22.00	26.00
FAUL1350-1R5MT	1.5±20%	3.2	26.40	33.00	19.00	23.00
FAUL1350-2R2MT	2.2±20%	5.0	19.20	24.00	13.00	15.00
FAUL1350-3R3MT	3.3±20%	7	17.60	22.00	12.00	14.00
FAUL1350-4R7MT	4.7±20%	9	16.00	20.00	11.00	13.00
FAUL1350-6R8MT	6.8±20%	18	12.80	16.00	10.00	12.00
FAUL1350-100MT	10±20%	22	9.60	12.00	8.00	9.00
FAUL1350-150MT	15±20%	30	8.00	10.00	7.00	8.00
FAUL1350-220MT	22±20%	58	5.20	6.50	3.80	4.50
FAUL1350-330MT	33±20%	84	4.80	6.00	2.80	3.50
FAUL1350-470MT	47±20%	130	4.00	5.00	2.60	3.00

FAUL1360-XXX Series

Part Number	Inductance	DC Resistance	Saturation Current ^{*3}		Heat Rating Current ^{*4}	
	@100KHZ, 1V	Max.	Max.	Typ.	Max.	Typ.
Units	uH	mΩ	A		A	
Symbol	L	DCR	Isat		Irms	
FAUL1360-1R5MT	1.5±20%	2.9	27	30	23	27
FAUL1360-2R2MT	2.2±20%	4.2	24	28	18	22
FAUL1360-3R3MT	3.3±20%	6.8	21	25	14	17
FAUL1360-4R7MT	4.7±20%	9	19.20	24.00	12.00	15.00
FAUL1360-5R6MT	5.6±20%	11	18.00	22.50	11.00	13.00
FAUL1360-6R8MT	6.8±20%	13.5	15.20	19.00	10.00	12.00
FAUL1360-8R2MT	8.2±20%	16	10.80	13.50	9.00	11.00
FAUL1360-100MT	10±20%	20.7	11.10	12.50	8.50	10.00
FAUL1360-120MT	12±20%	23	8.00	10.00	7.80	9.00
FAUL1360-150MT	15±20%	29	7.20	9.00	7.50	8.50
FAUL1360-180MT	18±20%	35	6.40	8.00	6.50	7.50
FAUL1360-220MT	22±20%	39.5	6.00	7.50	6.00	7.00
FAUL1360-270MT	27±20%	56	5.20	6.50	5.00	6.00
FAUL1360-330MT	33±20%	75	4.80	6.00	4.80	5.50
FAUL1360-470MT	47±20%	90	4.40	5.50	4.20	5.00
FAUL1360-680MT	68±20%	140	3.60	4.50	3.20	4.00
FAUL1360-101MT	100±20%	200	2.80	3.50	2.50	3.00
FAUL1360-121MT	120±20%	235	2.56	3.20	1.70	2.00
FAUL1360-151MT	150±20%	350	2.16	2.70	1.20	1.50

FAUL1365-XXX Series

Part Number	Inductance	DC Resistance	Saturation Current ³		Heat Rating Current ⁴	
	@100KHZ,1V	Max.	Max.	Typ.	Max.	Typ.
Units	uH	mΩ	A		A	
Symbol	L	DCR	Isat		Irms	
FAUL1365-4R7MT	4.7±20%	8.5	-	24	-	16
FAUL1365-5R6MT	5.6±20%	10.5	-	22.5	-	14
FAUL1365-6R8MT	6.8±20%	12	-	19	-	13
FAUL1365-8R2MT	8.2±20%	14	-	16	-	12
FAUL1365-100MT	10±20%	16.5	-	15	-	11
FAUL1365-150MT	15±20%	26	-	11	-	9.5
FAUL1365-220MT	22±20%	36	-	9	-	8
FAUL1365-330MT	33±20%	65	-	8	-	6.5
FAUL1365-470MT	47±20%	70	-	6.8	-	5.5
FAUL1365-680MT	68±20%	120	-	5.2	-	4.8
FAUL1365-820MT	82±20%	135	-	4.5	-	4.0
FAUL1365-101MT	100±20%	170	-	4.0	-	3.5

FAUL1770-XXX Series

Part Number	Inductance	DC Resistance	Saturation Current ³		Heat Rating Current ⁴	
	@100KHZ,1V	Max.	Max.	Typ.	Max.	Typ.
Units	uH	mΩ	A		A	
Symbol	L	DCR	Isat		Irms	
FAUL1770-2R2MT	2.2±20%	2.5	-	34	-	29
FAUL1770-3R3MT	3.3±20%	3.95	-	30	-	24
FAUL1770-4R7MT	4.7±20%	4.75	-	24	-	21
FAUL1770-6R8MT	6.8±20%	7.5	-	22	-	17
FAUL1770-8R2MT	8.2±20%	8.7	-	20	-	13
FAUL1770-100MT	10±20%	9.9	-	19	-	12

FAUL1770-150MT	15±20%	17	-	14.5	-	11
FAUL1770-220MT	22±20%	23	-	11.5	-	8.5
FAUL1770-330MT	33±20%	37	-	10	-	8.0
FAUL1770-470MT	47±20%	47	-	7.5	-	6.0
FAUL1770-680MT	68±20%	85	-	6.5	-	5.2
FAUL1770-101MT	100±20%	130	-	5.0	-	3.7

※1: All test data is referenced to 20°C ambient;

※2: Rated current: Isat or Irms, whichever is smaller;

※3: Isat(Typ): DC current at which the inductance drops approximate 30% from its value without current;

※4: Isat(Max): DC current at which the inductance drops approximate 20% from its value without current;

※5: Irms(Typ): DC current that causes the temperature rise ($\Delta T = 40^{\circ}\text{C}$) from 20°C ambient.

※6: Irms(Max): DC current that causes the temperature rise ($\Delta T = 20^{\circ}\text{C}$) from 20°C ambient.

※7: Absolute maximum voltage 30VDC

Test and Measurement Procedures

Test Conditions

1 Unless otherwise specified, the standard atmospheric conditions for measurement/test as:

- a. Ambient Temperature: $20\pm 15^{\circ}\text{C}$
- b. Relative Humidity: $65\pm 20\%$
- c. Air Pressure: 86 KPa to 106 KPa

2 If any doubt on the results, measurements/tests should be made within the following limits:

- a. Ambient Temperature: 20 ± 2
- b. Relative Humidity: $65\pm 5\%$
- c. Air Pressure: 86KPa to 106 KPa

3 Visual Examination

- a. Inspection Equipment: 10 X magnifier

4 Electrical Test

DC Resistance (DCR)

- a. Refer to **Appendix A**.
- b. Test equipment (Analyzer): HIOKI3540 or equivalent.

Inductance (L)

- a. Refer to **Appendix A**.
- b. Test equipment: Wayne kerr3260+3265B or equivalent.

Rated Current

- a. Refer to **Appendix A**.
- b. Test equipment: Wayne kerr3260+3265B, Agilent E3633A, R2M-2H3 or equivalent.
- c. Definition of Rated Current (I_r): With the condition of the DC current pass, the inductance decrease approximate 30% of the standard value, compare to the temperature rise approximate 40°C , the smaller is Rated Current.(reference environment temperature: 20°C)

Mechanical Reliability		
Item	Specification and Requirement	Test Method
Solderability	1. No case deformation or change in appearance 2. New solder coverage More than 95%	1. Preheat: 155°C ± 5°C , 60S ± 2S 2. Tin: lead-free. 3. Temperature: 240°C ± 5°C , flux 3.0S ± 0.5S.
Mechanical shock	1. No case deformation or change in appearance 2. $\Delta L/L_0 \leq \pm 10\%$	1. Peak value: 100G 2. Pulse time: 6ms 3. 3 times in each positive and negative direction of 3 mutual perpendicular directions
Mechanical vibration	1. No case deformation or change in appearance 2. $\Delta L/L_0 \leq \pm 10\%$	1. Reflow: 2 times 2. Frequency: 10HZ ~ 2000HZ ~ 10HZ, 20 Min/Cycles 3. Amplitude: 1.52 mm 4. Directions: X,Y,Z 5. Time: 12 cycle / direction
Endurance Reliability		
Item	Specification and Requirement	Test Method
Thermal Shock	Inductance change: Within $\pm 10\%$ Without distinct damage in appearance	1. Repeat 100 cycles as follow: (-55 ± 2 °C; 30 ± 3 min) → (Room temp., 5 min) → (+155 ± 2 °C, 30 ± 3 min) → (Room temp., 5 min) 2. Recovery: 48 + 4 / -0 hours of recovery under the standard condition after the test.
Humidity Resistance	Inductance change: Within $\pm 10\%$ Without distinct damage in appearance	1. Reflow 2 times, 2. 85°C, 85%RH, 1000 hours 3. Measured at room temperature after placing for 24 ± 2 hours
Low temperature storage	Inductance change: Within $\pm 10\%$ Without distinct damage in appearance	1. Temperature: -55 ± 2°C 2. Time: 1000 hours 3. Measured at room temperature after placing for 24 ± 2 hours
High temperature storage	Inductance change: Within $\pm 10\%$ Without distinct damage in appearance	1. Temperature: +155 ± 2°C 2. Time: 1000 hours 3. Measured at room temperature after placing for 24 ± 2 hours

Recommended Soldering Technologies

(1) Re-flowing Profile

Preheat condition: 150 ~200°C/60~120sec.

Allowed time above 217°C: 60~90sec.

Max temp: 260°C

Max time at max temp: 10 sec.

Solder paste: Sn/3.0Ag/0.5Cu

Allowed Reflow time: 2x max



(2) Iron Soldering Profile

Iron soldering power: Max. 30W

Pre-heating: 150°C/60sec.

Soldering Tip temperature: 350°C Max.

Soldering time: 3sec. Max.

Solder paste: Sn/3.0Ag/0.5Cu

Max.1 times for iron soldering



Packaging, Storage and Transportation

Tape Carrier Packaging:

Packaging code: T

Tape carrier packaging are specified in attached figure Fig: a1、a2

Tape carrier packaging quantity:

Type	Standard Quantity (pcs/reel)	Type	Standard Quantity (pcs/reel)
FAUL0412	3000	FAUL0630	1500
FAUL0420	3000	FAUL0640	1000
FAUL0518	2000	FAUL0650	1000
FAUL0530	2000	FAUL1040	500
FAUL0618	1500	FAUL1340	500
FAUL0620	1500	FAUL1350	500
FAUL0624	1500	FAUL1360	500
FAUL1365	500	FAUL1770	200
FAUL1030	800	FAUL1050	500
FAUL0754	500		

Taping Drawings (Unit: mm) Fig:a1

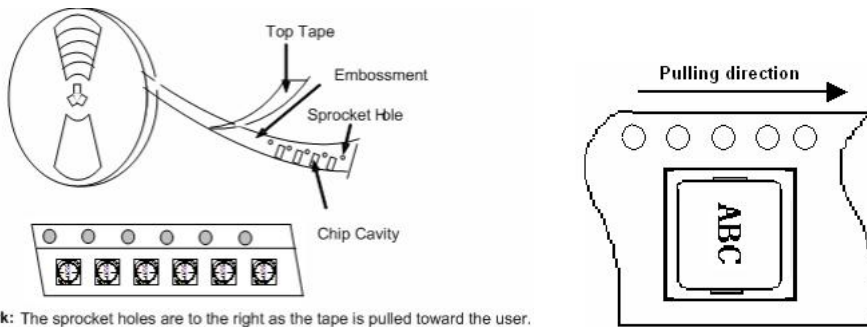

Remark: The sprocket holes are to the right as the tape is pulled toward the user.

Reel and Taping Dimensions (Unit: mm) Fig:a2

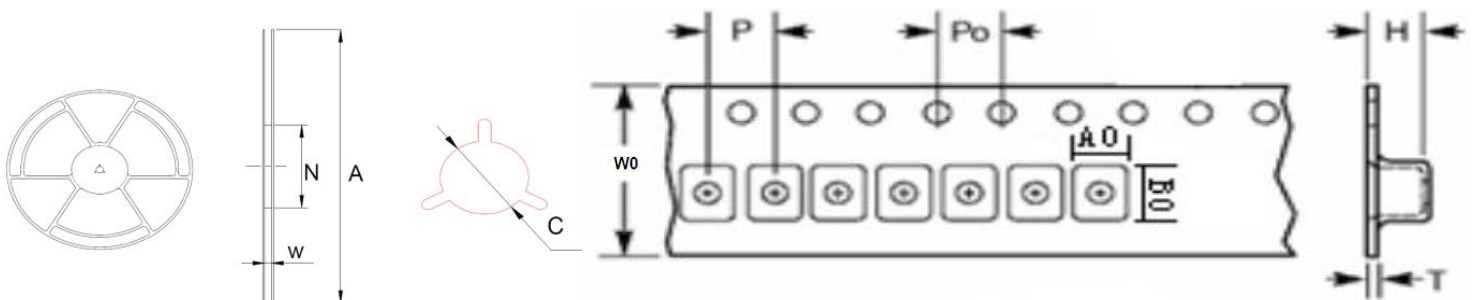

更多资讯,请点击长江微电官网 more information,Please click: WWW.CJIANG.COM.CN

Remark: (FAUL0412- FAUL1770)

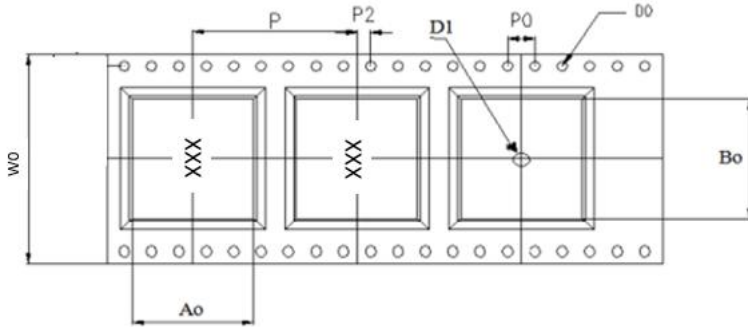

Type	Reel dimensions (mm)				Tape dimensions (mm)							
	A	N	C	W	W0	P	P0	H	T	A0	B0	
FAUL0412	330±2.0	100±2.0	13±1.0	12.4± 2.0	12±0.3	8±0.1	4±0.1	1.5± 0.05	0.30± 0.05	4.4±0.1	4.9±0.1	
FAUL0420	330±2.0	100±2.0	13±1.0	12.4± 2.0	12±0.3	8±0.1	4±0.1	2.3± 0.05	0.35± 0.05	4.4±0.1	4.9±0.1	
FAUL0518	330±2.0	100±2.0	13±1.0	12.4± 2.0	12±0.3	8±0.1	4±0.1	2.1 ± 0.05	0.35± 0.05	5.4±0.1	5.9±0.1	
FAUL0530	330±2.0	100±2.0	13±1.0	12.4± 2.0	12±0.3	8±0.1	4±0.1	3.3± 0.05	0.35± 0.05	5.4±0.1	5.9±0.1	
FAUL0618	330±2.0	100±2.0	13±1.0	16.4± 2.0	16±0.3	12±0.1	4±0.1	2.1 ± 0.05	0.35± 0.05	6.9±0.1	7.5±0.1	
FAUL0620	330±2.0	100±2.0	13±1.0	16.4± 2.0	16±0.3	12±0.1	4±0.1	2.2±0.1	0.35± 0.05	6.9±0.1	7.5±0.1	
FAUL0624	330±2.0	100±2.0	13±1.0	16.4± 2.0	16±0.3	12±0.1	4±0.1	2.7± 0.05	0.35± 0.05	6.9±0.1	7.5±0.1	
FAUL0630	330±2.0	100±2.0	13±1.0	16.4± 2.0	16±0.3	12±0.1	4±0.1	3.3± 0.05	0.35± 0.05	6.9±0.1	7.5±0.1	
FAUL0640	330±2.0	97±0.5	13.2± 0.2	16.8± 2.0	16±0.3	12±0.1	4±0.1	4.2± 0.10	0.35± 0.05	6.9±0.1	7.5±0.1	
FAUL0650	330±2.0	100±2.0	13±1.0	16.4± 2.0	16±0.3	12±0.1	4±0.1	5.2± 0.10	0.4± 0.05	6.9±0.1	7.5±0.1	
FAUL0754	330±2.0	97±0.5	13.2± 0.2	16.8± 2.0	16±0.3	12±0.1	4±0.1	5.7± 0.10	0.4± 0.05	7.6±0.1	8.1±0.1	

FAUL1030	330±2.0	100±2.0	13±1.0	24.4± 2.0	24±0.3	16±0.1	4±0.1	3.3± 0.10	0.35± 0.05	10.4± 0.1	11.6± 0.1
FAUL1040	330±2.0	100±2.0	13±1.0	24.4± 2.0	24±0.3	16±0.1	4±0.1	4.3± 0.10	0.35± 0.05	10.4± 0.1	11.5± 0.1
FAUL1340	330±2.0	100±2.0	13±1.0	24.4± 2.0	24±0.3	16±0.1	4±0.1	4.3± 0.10	0.5± 0.05	13.4± 0.1	14.4± 0.1
FAUL1050	330±2.0	100±2.0	13±1.0	24.4± 2.0	24±0.3	16±0.1	4±0.1	5.4± 0.10	0.5± 0.05	10.4± 0.1	11.6± 0.1
FAUL1350	330±2.0	100±2.0	13±1.0	24.4± 2.0	24±0.3	16±0.1	4±0.1	5.3± 0.10	0.5± 0.05	13.2± 0.1	14.4± 0.1
FAUL1360	330±2.0	100±2.0	13±1.0	24.4± 2.0	24±0.3	16±0.1	4±0.1	6.3± 0.10	0.5± 0.05	13.2± 0.1	14.4± 0.1
FAUL1365	330±2.0	97±0.5	13±0.2	24.0± 0.5	24±0.3	16±0.1	4±0.1	6.8± 0.10	0.5± 0.05	13.1 ± 0.1	14.0± 0.1
FAUL1770	330±2.0	97±0.5	13±0.2	24.4± 2.0	32±0.3	24±0.1	4±0.1	7.3± 0.10	0.5± 0.05	17.5± 0.1	18.1 ± 0.1

Peeling off force: 10gf to 130gf in the direction show below. Fig:C1

Top tape or cover tape



Storage

- (1) The solderability of the external electrodes may deteriorate if packages are stored in high humidity. Besides, to ensure packing material's good state, packages must be stored at -10℃ to 40℃ and 70% RH Max.
- (2) The solderability of the external electrodes may deteriorate if packages are exposed to dust of harmful gas (e.g. HCl, sulfurous gas of H₂S).
- (3) Packaging materials may deform if packages are exposed directly to sunlight.
- (4) Minimum packages, such as polyvinyl heat-seal packages shall not be opened until they are used. If opened, use the reels as soon as possible.
- (5) Solderability shall be guaranteed for a period of time from the date of delivery on condition that they are stored at the specified environment.
For those parts, which passed more than the time shall be checked solderability before using.
- (6) For magnetic products, keep clear of anything that may generate magnetic fields to avoid change of products performance.
- (7) To avoid any damage to products, do not load mechanic force on products or place heavy goods on products, and exclude strong vibration or drop.
- (8)** In case of storage over 12 months, solderability shall be checked before actual usage.

Warning and Attentions

Precautions on Use

- (1) Always wear static control bands to protect against ESD.
- (2) Any devices used with the products (soldering irons, measuring instruments) should be properly grounded.
- (3) Keep bare hands and metal conductors (i.e., metal desk) away from electrodes or conductive areas that lead to electrodes.
- (4) Preheat when soldering.
- (5) Don't apply current in excess of the rated current value. It may reduce the impedance or inductance, or cause damage to components due to over-current.
- (6) For magnetic products, keep clear of anything that may generate magnetic fields such as speakers and coils. Use non-magnetic tweezers when handing the chips.
- (7) When soldering, the electrical characteristics may be varied due to hot energy and mechanical stress.
- (8) When coating products with resin, the relatively high resin curing stress may change the electrical characteristics. For exterior coating, select resin carefully so that electrical and mechanical performance of the product is not affected. Before using, please evaluate reliability with the product mounted in your application set.
- (9) When mount chips with adhesive in preliminary assembly, do appropriate check before the soldering stage, i.e., the size of land pattern, type of adhesive, amount applied, hardening of the adhesive on proper usage and amounts of adhesive to use.
- (10) Mounting density: Add special attention to radiating heat of products when mounting other components nearby. The excessive heat by other products may cause deterioration at joint of this product with substrate.
- (11) Since some products are constructed like an open magnetic circuit, narrow spacing between components may cause magnetic coupling.
- (12) Please do not give the product any excessive mechanical shocks in transportation.
- (13) Please do not touch wires by sharp terminals such as tweezers to avoid causing any damage to wires.
- (14) Please do not add any shock and power to the soldered product to avoid causing any damage to chip body.
- (15) Please do not touch the electrodes by naked hand as the solderability of the external electrodes may deteriorate by grease or oil on the skin.

PCB Bending Design

The following shall be considered when designing and laying out PCB's.

- (1) PCB shall be designed so that products are not subjected to the mechanical stress from board warp or deflection.

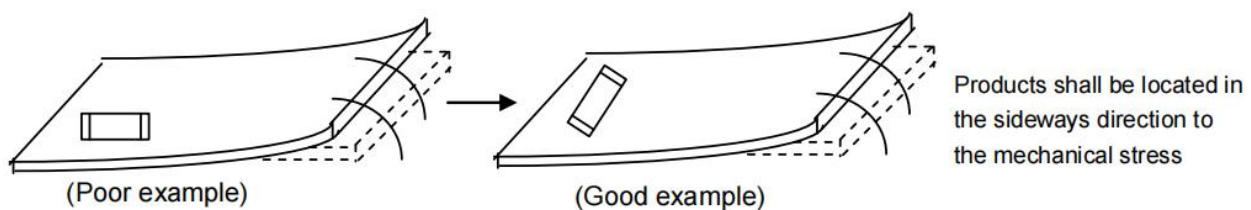

- (2) Products location on PCB separation.

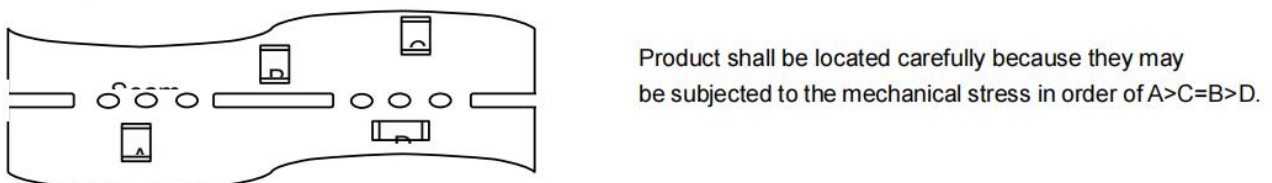

- (3) When splitting the PCB board, or insert (remove) connector, or fasten thread after mounting components, care is required so as not to give any stress of deflection or twisting to the board. Because mechanical force may cause deterioration of the bonding strength of electrode and solder, even crack of product body. Board separation should not be done manually, but by using appropriate device

Recommended PCB Design for SMT Land-Patterns

When chips are mounted on a PCB, the amount of solder used (size of fillet) can directly affect chip performance. Therefore, the following items must be carefully considered in the design of solder land patterns:

- (1) The amount of solder applied can affect the ability of chips to withstand mechanical stresses which may lead to breaking or cracking. Therefore, when designing land-patterns it is necessary to consider the appropriate size and configuration of the solder pads which in turn determines the amount of solder necessary to form the fillets.
- (2) When more than one part is jointly soldered onto the same land or pad, the pad must be designed that each component's soldering Point is separated by solder-resist
Recommended land dimensions please refer to product specification.

Inner Box

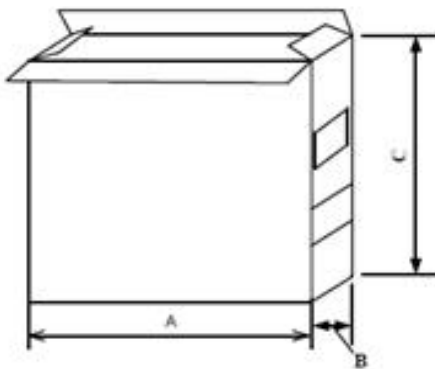

Packaging type	A (mm)	B (mm)	C (mm)
Inner box	335	70	340

Carton

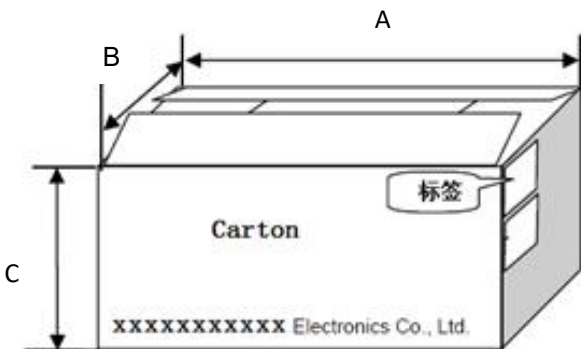

Packaging type	A (mm)	B (mm)	C (mm)
type	360	360	360

X-ON Electronics

Largest Supplier of Electrical and Electronic Components

Click to view similar products for [Fixed Inductors](#) category:

Click to view products by [Changjiang Microelectronics](#) manufacturer:

Other Similar products are found below :

[CR32NP-100KC](#) [70F224AI](#) [MHQ1005P10NJ](#) [MHQ1005P1N0S](#) [MHQ1005P2N4S](#) [MHQ1005P3N6S](#) [MHQ1005P5N1S](#) [MHQ1005P8N2J](#)
[PE-53601NL](#) [PE-53602NL](#) [PG0936.113NLT](#) [9220-20](#) [9310-16](#) [PM06-2N7](#) [PM06-39NJ](#) [A01TK](#) [1206CS-471XJ](#) [HC2-R47-R](#) [HC8-1R2-R](#)
[HCF1305-3R3-R](#) [1206CS-151XG](#) [RCH664NP-4R7M](#) [RCP1317NP-391L](#) [DH2280-4R7M](#) [DS1608C-106](#) [B10TJ](#) [B82498B3101J000](#) [ELJ-](#)
[RE27NJF2](#) [1812CS-153XJ](#) [1812CS-183XJ](#) [1812CS-223XJ](#) [1812LS-104XJ](#) [1812LS-105XJ](#) [1812LS-124XJ](#) [1812LS-154XJ](#) [1812LS-223XJ](#)
[1812LS-224XJ](#) [1812LS-563XJ](#) [1812LS-683XJ](#) [1812LS-824XJ](#) [NIN-FB101JTR110F](#) [NIN-FB471JTR62F](#) [NIN-FC1R5JTR220F](#) [NIN-](#)
[HCR15JTRF](#) [NIN-HCR33JTRF](#) [NIN-HDR22JTRF](#) [NIN-HDR82JTRF](#) [NIN-HK2N7STRF](#) [NIN-PA150KTR370F](#) [NIN-PB100KTR550F](#)