

1. Features

- High common mode impedance at high frequency effects excellent noise suppression performance.
- FDCW2012series realizes small size and low profile 2.0*1.2*1.2 mm.
- 100% Lead (Pb) & Halogen-Free and RoHS compliant.



2. Applications

- Power switch and servers.
- USB communication.
- Telecommunication applications.
- Panel link for LCD panels.
- Countering common mode noise affecting signals in high-speed lines.

3. Product Identification

FDCW 2012 -2 -900 T F
 ① ② ③ ④ ⑤ ⑥

- ① FDCW ----- Series name
- ② 2012 ----- Dimension
- ③ 2 ----- 2 lines
- ④ 900 ----- Common Mode Impedance (Ω)
- ⑤ T ----- Packing (Tape & Reel)
- ⑥ F ----- HSF Products (Hazardous Substance Free Products)

4. Dimensions

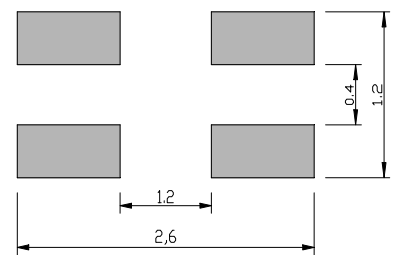
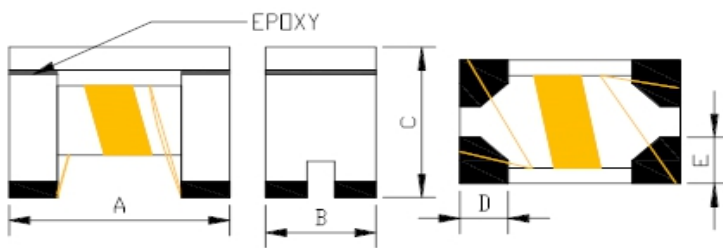

Recommend Land Patter

Unit:mm

A	B	C	D	E
2.00±0.20	1.20±0.20	1.20±0.20	0.5TYP	0.5TYP

5. Structure and Components

No	Part Name	Material Name
①	Lid	Ni-Zn Ferrite
②	Epoxy	Epoxy resin
③	Wire	Enameled copper wire
④	Core	Ni-Zn Ferrite
⑤	Electrode structure	Ag+Ni+Sn plating

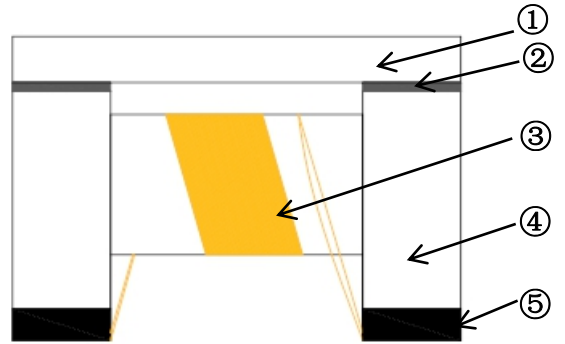

6. Schematic Diagram

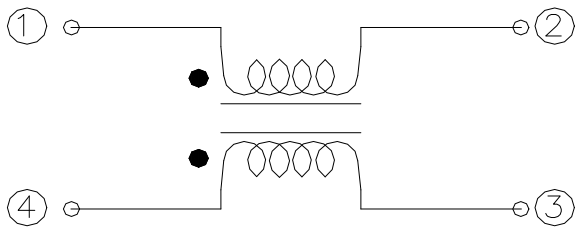

7. MEASURING CIRCUITS 2LINE

1) Common mode:

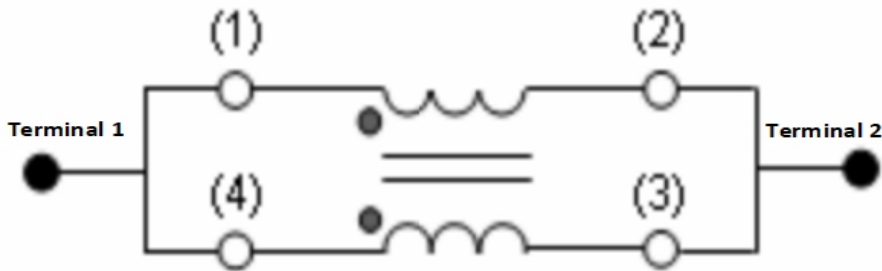

2) Differential mode:

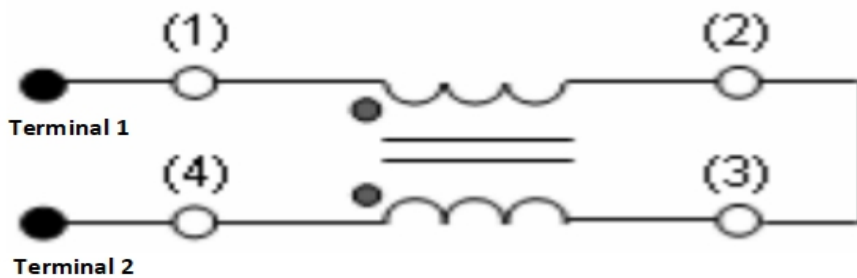

8. Electrical Characteristics

Part No.	Z (共模阻抗) @100MHZ	DCR	IR	Rated Voltage (Vdc)	Rated Current
	Ω	mΩ	MΩ	V	mA
	±25%	MAX	MIN	/	MAX
FDCW2012-2-300TF	30	200	10	50	450
FDCW2012-2-500TF	50	250	10	50	550
FDCW2012-2-750TF	75	250	10	50	400
FDCW2012-2-900TF	90	300	10	50	400
FDCW2012-2-121TF	120	300	10	50	400
FDCW2012-2-161TF	160	350	10	50	350
FDCW2012-2-181TF	180	350	10	50	350
FDCW2012-2-201TF	200	350	10	50	300
FDCW2012-2-221TF	220	350	10	50	300
FDCW2012-2-251TF	250	400	10	50	300
FDCW2012-2-261TF	260	400	10	50	300
FDCW2012-2-301TF	300	400	10	50	290
FDCW2012-2-361TF	360	400	10	50	300
FDCW2012-2-371TF	370	450	10	50	280
FDCW2012-2-481TF	480	550	10	50	200
FDCW2012-2-501TF	500	550	10	50	200
FDCW2012-2-601TF	600	550	10	50	300
FDCW2012-2-671TF	670	600	10	50	180
FDCW2012-2-681TF	680	700	10	50	180
FDCW2012-2-751TF	750	800	10	50	150
FDCW2012-2-801TF	800	1000	10	50	300
FDCW2012-2-901TF	900	1000	10	50	100
FDCW2012-2-102TF	1000	1000	10	50	100

Notes

1. All test data is referenced to 25 °C ambient.
2. Operating temperature range - 40 °C to + 85 °C.
3. I_{rms} (A):DC current (A) that will cause an approximate ΔT of 40 °C(reference ambient temperature is 25 °C).
4. The part temperature (ambient + temp rise) should not exceed 125 °C under worst case operating conditions.
Circuit design, component placement, PWB trace size and thickness, airflow and other cooling provisions.
all affect the part temperature. Part temperature should be verified in the end application.

9. Typical impedance vs. frequency

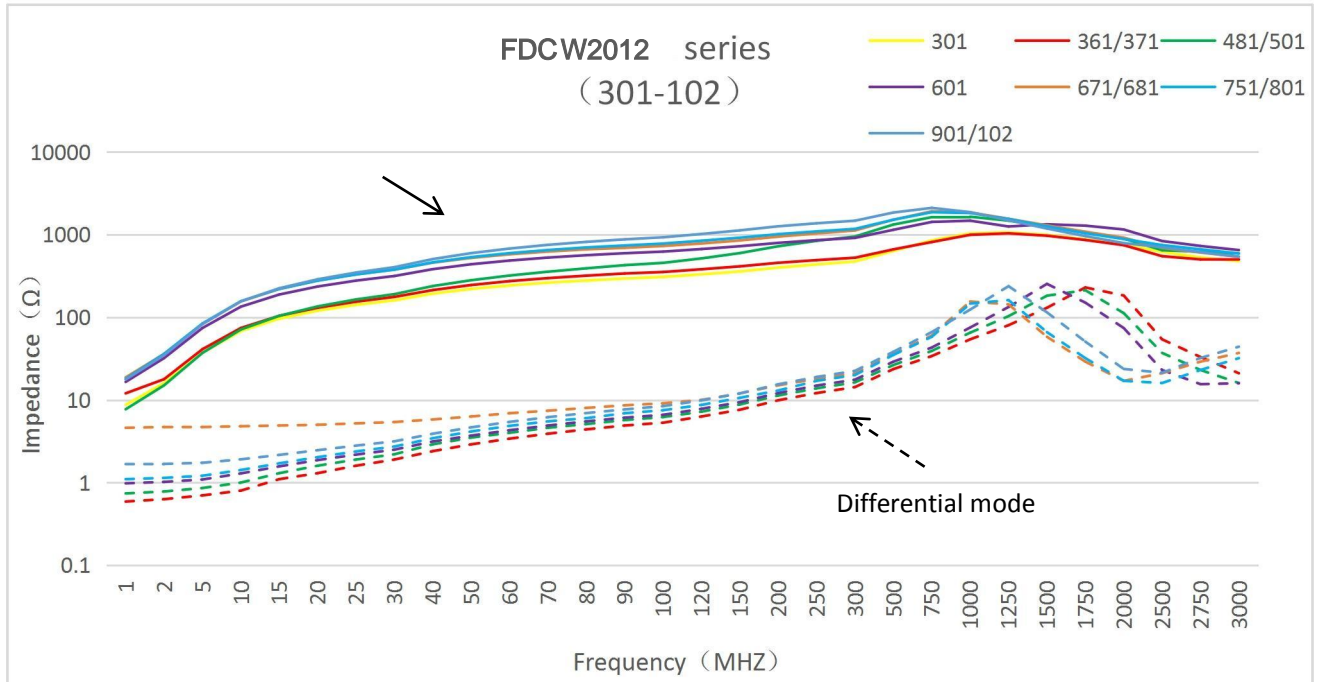
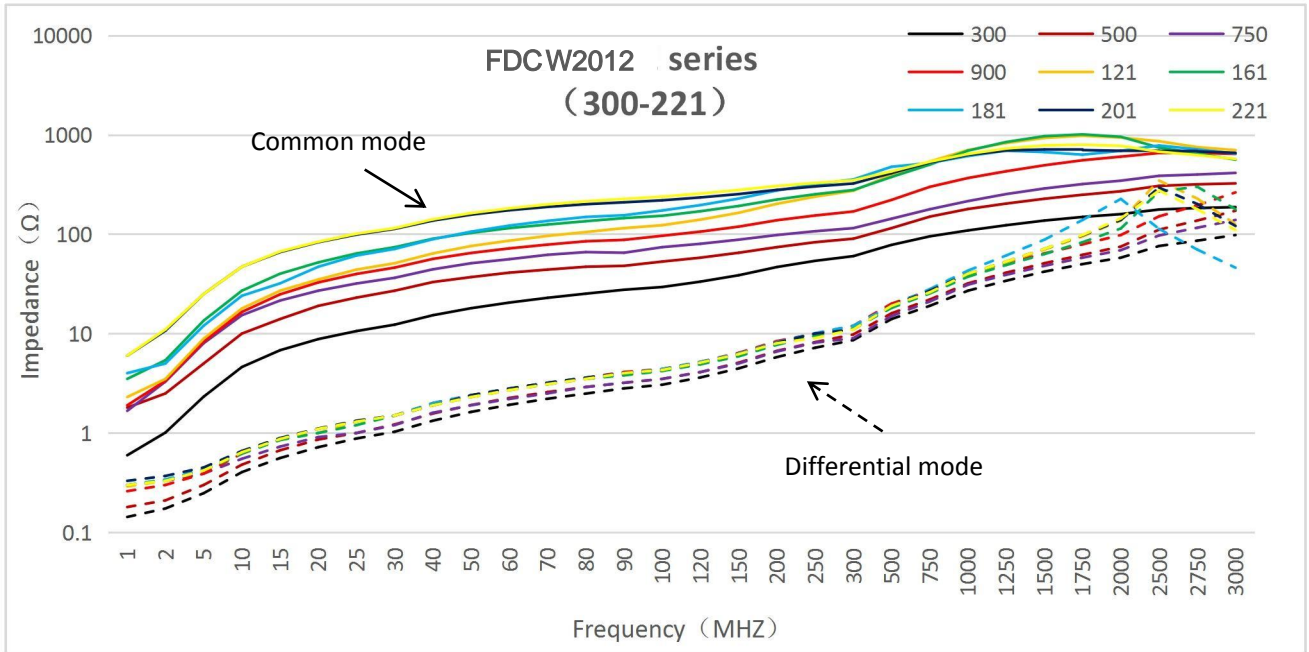

10. Reliability Test

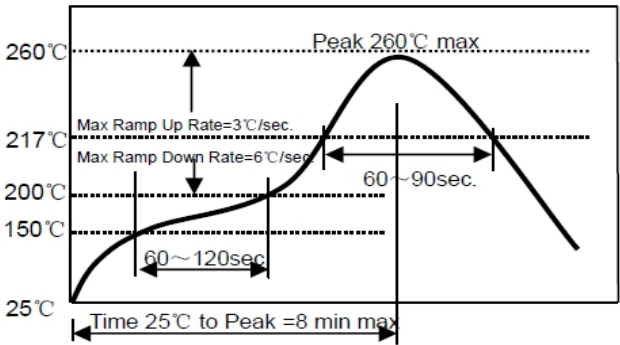
Items	Requirements	Test Methods and Remarks
Operating life	1. No visible mechanical damage 2. Impedance change: Within $\pm 20\%$ 3. Insulation resistance: 10M Ω min	1. Reflow 2 times 2. temperature: 155 ± 2 °C
Resistance to Soldering Heat	1. No visible mechanical damage 2. Impedance change: Within $\pm 20\%$	1. Solder on PCB to Reflow test Peak Temp. 260 ± 5 °C 5~10 secs ,Cycles :2 times..Re-flowing Profile: Please refer to Fig-1 2. Test board thickness: 1.5mm 3. Test board material: glass epoxy resin 4. The specimen shall be stored at standard atmospheric conditions for 1 hour, after which the measurement shall be made.product showed no damage under microscope. <div style="text-align: center;"> <p>Fig-1</p>  </div>
High Temperature	1. No visible mechanical damage 2. Impedance change: Within $\pm 20\%$ 3. Insulation resistance: 10M Ω min	1. Temperature: 125 ± 2 °C 2. Duration: 1000 hours The specimen shall be stored at standard atmospheric conditions for 1 hour, after which the measurement shall be made.
Steady damp-heat	1. No visible mechanical damage 2. Impedance change: Within $\pm 20\%$ 3. Insulation resistance: 10M Ω min	1. Temperature:85°C 2. Humidity: 85% RH 3. Duration:1000 hours 4. The specimen shall be stored at standard atmospheric conditions for 1 hour, after which the measurement shall be made.
Mechanical Vibration	1. No visible mechanical damage 2. Impedance change: Within $\pm 20\%$	1. Frequency: 10HZ~55HZ~10HZ/Min Cycles 2. Amplitude: 1.5 mm 3. Directions: X,Y,Z 4. Time: 2 hours in each directions (total of 6 hours)

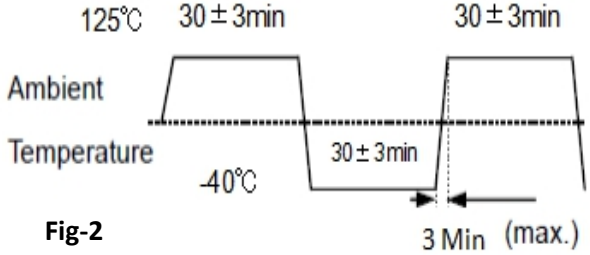
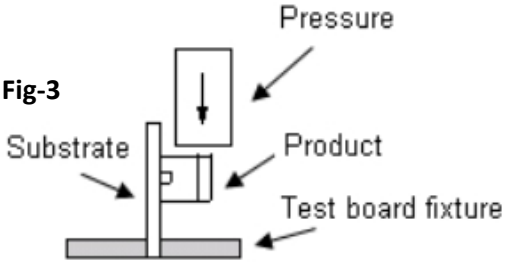
Items	Requirements	Test Methods and Remarks
Thermal Shock	1. No visible mechanical damage 2. Impedance change: Within $\pm 20\%$ 3. Insulation resistance: $10M\Omega$ min	1. Temperature and time: -40°C for 30 ± 3 min \rightarrow 125°C for 30 ± 3 min, please refer to Fig-2 2. Transforming interval: Max. 3 Min 3. Tested cycle: 1000 cycles 4. The specimen shall be stored at standard atmospheric conditions for 1 hour, after which the measurement shall be made.  <p>Fig-2</p>
Salt Spray	1. No visible mechanical damage 2. Impedance change: Within $\pm 20\%$	1. Salt concentration: $(5 \pm 1)\%$ (mass percent) 2. pH value: 6.5 - 7.2 3. temperature: $35 \pm 2^{\circ}\text{C}$ 4. humidity: 85% 5. time: 24 hours 6. in normal temperature and humidity for 1 ~ 2 hours, testing inductance, the inductance value change can not be more than before test $\pm 10\%$.
Terminal strength	No visible mechanical damage	1. The electrode of the inductor is soldered to the PCB, to Fig-3 Then apply a force in the direction of the arrow. 2. 5N force. 3. Keep time: $10(\pm 1)\text{s}$ The first three tests were OK, and the force was applied until the peak value of the product peeling. The test speed was set in the range of 3 ~ 8mm/min.  <p>Fig-3</p>

11 . Packaging Information

1) Tape Packaging Dimensions

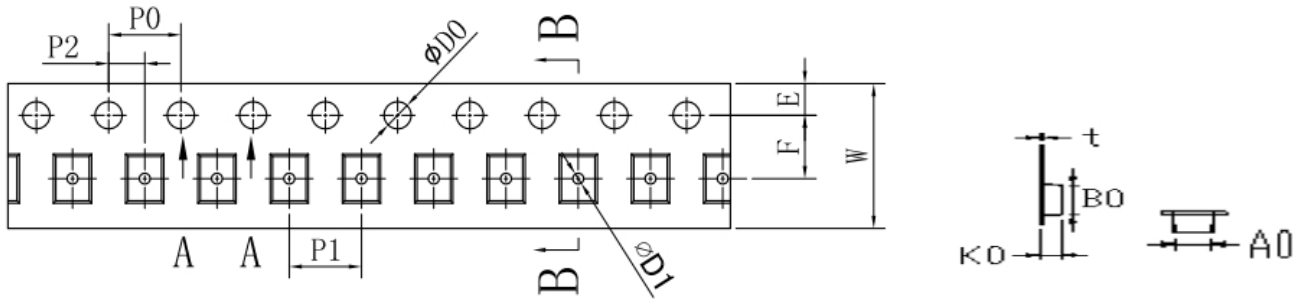

(Unit: mm)

Type	W	P1	A0	B0	K0	t	E	F	P2	D0	D1	P0
FDCW 2012	8.00 ±0.10	4.00 ±0.10	1.50 ±0.10	2.30 ±0.10	1.45 ±0.10	0.20 ±0.05	1.75 ±0.10	3.50 ±0.10	2.00 ±0.10	1.55 ±0.05	0.80 ±0.05	4.00 ±0.10

2) Leader and blank portion

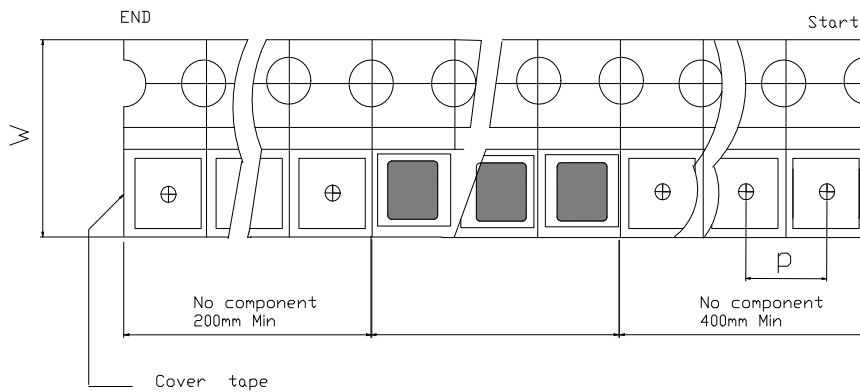

3) Taping Drawings

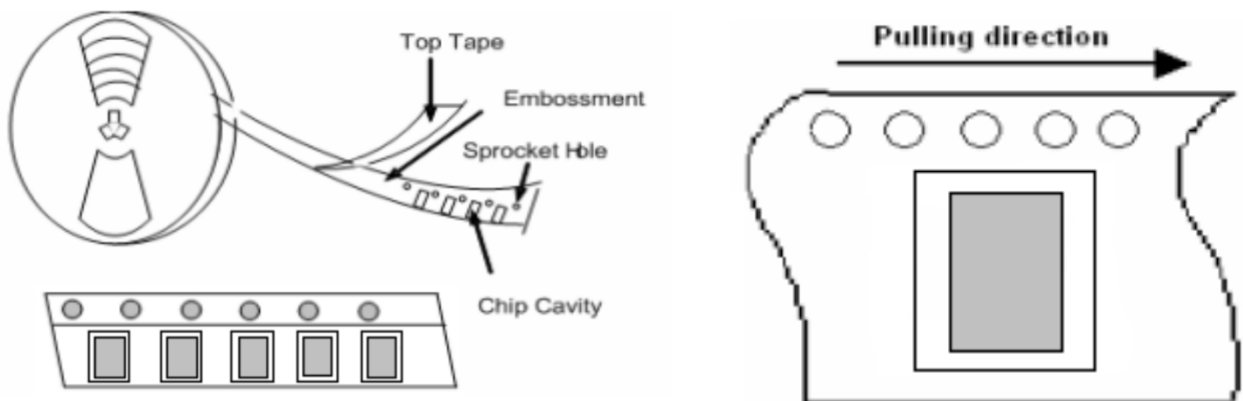

4) Reel Dimensions (Unit: mm)

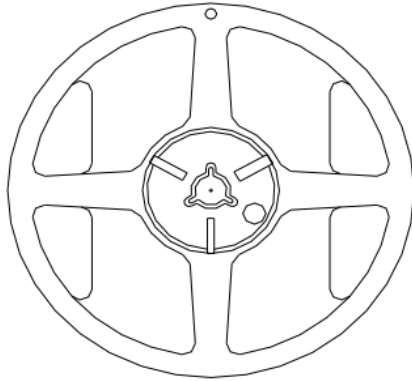
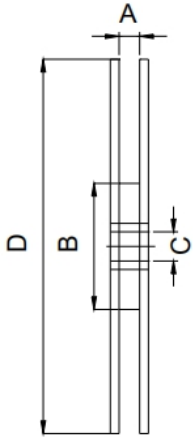

A (mm)	9.50 ± 1.0
B (mm)	60.0 ± 1.0
C (mm)	13.0 ± 0.2
D (mm)	178.0 ± 1.0

5) Packaging Quantity

Type	Standard Quantity		
	Reel	Inner box	Carton box
FDCW2012	2000 pcs / reel	5Reel / box (10000 pcs)	10 Middle boxes, (100000 pcs)

6) Peel force of top cover tape

The peel speed shall be about 300mm/minute.

The peel force of top cover tape shall be between 10 to 100gf.

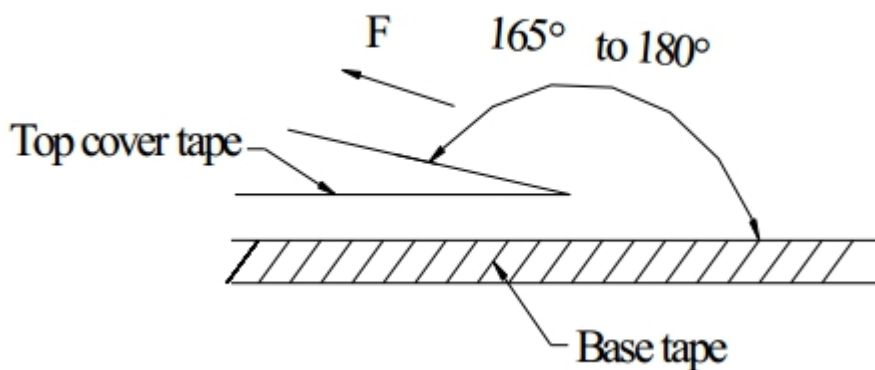

7) Reel Label

- Label on the reel
 - Customer's part Number
 - Lot Number
 - Quantity
 - date code

- Shipping Label
 - Customer's part Number
 - Manufacturer's part Number
 - Quantity
 - date code

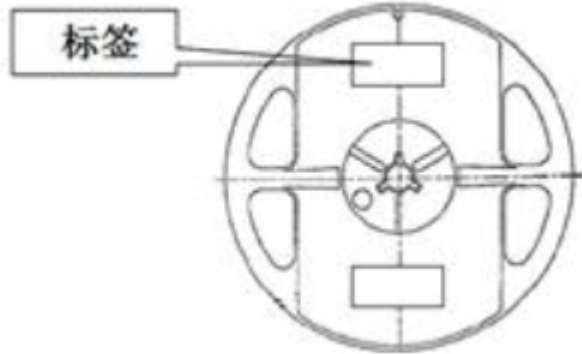

8) Inner Box

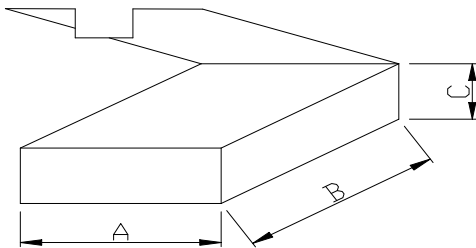

Packaging Type	A (mm)	B (mm)	C (mm)
Inner box	188	195	67

9) Carton

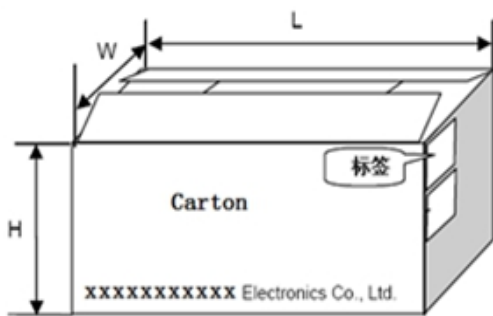

Packaging Type	L (mm)	W (mm)	H (mm)
Carton	390	350	215

X-ON Electronics

Largest Supplier of Electrical and Electronic Components

Click to view similar products for [Common Mode Chokes / Filters](#) *category:*

Click to view products by [Changjiang Microelectronics](#) *manufacturer:*

Other Similar products are found below :

[PE-64683](#) [RD5122-6-9M6](#) [RD6137-6-7M5](#) [RD8147-16-3M0](#) [ST6118T-R](#) [FE3X025-10-7NL](#) [RD7147-25-0M7](#) [TCM0806G-350-2P-T](#)
[TCM0806G-650-2P-T](#) [IND-0110](#) [UAL21VR0802000](#) [UALSC023000000](#) [UALSC1020JH000](#) [UALSU10VD20010](#) [UALSU9VD070100](#) [36-00037](#) [UALW21HS072450](#) [UALSU9H0208000](#) [UAL24VK06450CH](#) [PLT10HH501100PNB](#) [PLT10HH401100PNB](#) [PLT10HH1026R0PNB](#)
[36-00029-01](#) [PE-67531](#) [TLH10UB](#) [113 0R5](#) [2752045447](#) [7351V](#) [CMF16-153131](#) [RD7147-6-6M0](#) [T8116NLT](#) [FE2X10-4-2NL](#) [36-00029-07](#)
[T8003NLT](#) [CTX01-13663](#) [CTX66-19521-R](#) [RC212-0.5-10M](#) [RC112-0.4-15M](#) [RC212-0.6-6M8](#) [RC212-0.4-15M](#) [RC112-0.3-30M](#)
[WTCF2012Z0M751PB](#) [PH9408.814NLT](#) [PAC6006.364NLT](#) [PAC6006.444NLT](#) [PAC6006.204NLT](#) [PH9407.204NLT](#) [PAC6006.264NLT](#)
[PH9408.105NLT](#) [PH9408.494NLT](#) [PAC6006.104NLT](#)