

1. Features

- High common mode impedance at high frequency effects excellent noise suppression performance.
- FDCW2012series realizes small size and low profile 2.0*1.2*1.2 mm.
- 100% Lead (Pb) & Halogen-Free and RoHS compliant.



2. Applications

- Power switch and servers.
- USB communication.
- Telecommunication applications.
- Panel link for LCD panels.
- Countering common mode noise affecting signals in high-speed lines.

3. Product Identification

FDCW 2012 -2 -900 T F
 ① ② ③ ④ ⑤ ⑥

- ① FDCW ----- Series name
- ② 2012 ----- Dimension
- ③ 2 ----- 2 lines
- ④ 900 ----- Common Mode Impedance (Ω)
- ⑤ T ----- Packing (Tape & Reel)
- ⑥ F ----- HSF Products (Hazardous Substance Free Products)

4. Dimensions

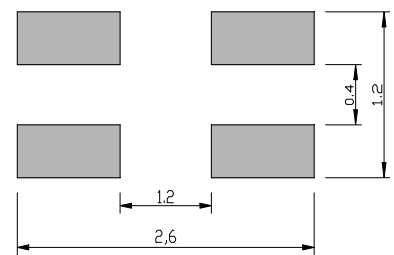
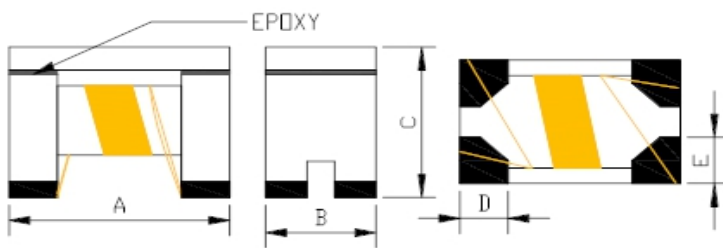

Recommend Land Patter

Unit:mm

| A | B | C | D | E |
|-----------|-----------|-----------|--------|--------|
| 2.00±0.20 | 1.20±0.20 | 1.20±0.20 | 0.5TYP | 0.5TYP |

5. Structure and Components

| No | Part Name | Material Name |
|----|---------------------|----------------------|
| ① | Lid | Ni-Zn Ferrite |
| ② | Epoxy | Epoxy resin |
| ③ | Wire | Enameled copper wire |
| ④ | Core | Ni-Zn Ferrite |
| ⑤ | Electrode structure | Ag+Ni+Sn plating |

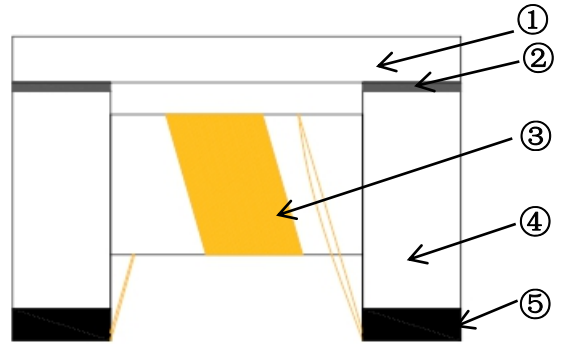

6. Schematic Diagram

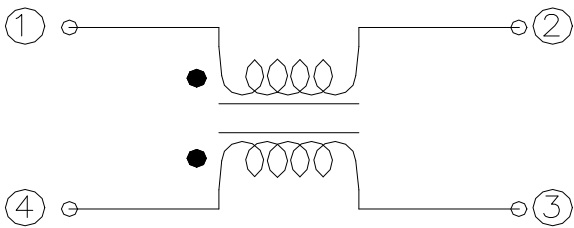

7. MEASURING CIRCUITS 2LINE

1) Common mode:

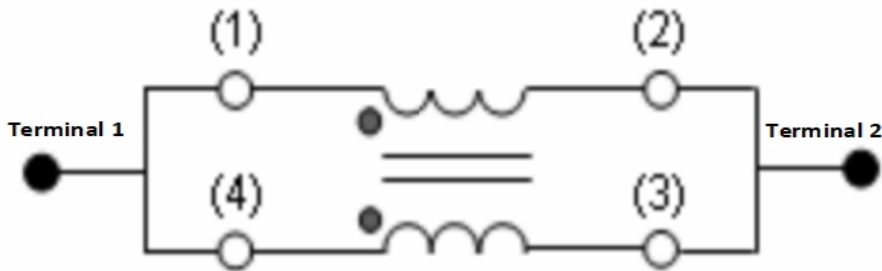

2) Differential mode:

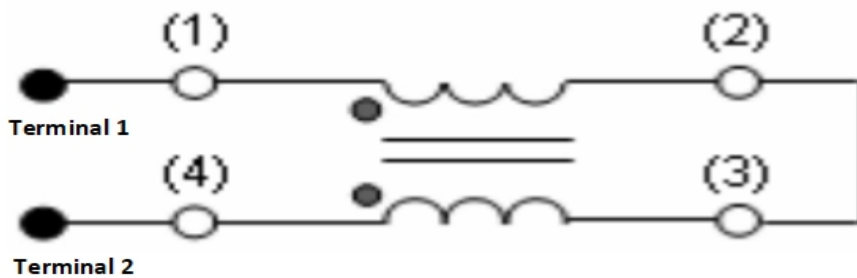

8. Electrical Characteristics

| Part No. | Z (共模阻抗) @100MHZ | DCR | IR | Rated Voltage (Vdc) | Rated Current |
|------------------|---------------------|------|-----|------------------------|---------------|
| | Ω | mΩ | MΩ | V | mA |
| | ±25% | MAX | MIN | / | MAX |
| FDCW2012-2-300TF | 30 | 200 | 10 | 50 | 450 |
| FDCW2012-2-500TF | 50 | 250 | 10 | 50 | 550 |
| FDCW2012-2-750TF | 75 | 250 | 10 | 50 | 400 |
| FDCW2012-2-900TF | 90 | 300 | 10 | 50 | 400 |
| FDCW2012-2-121TF | 120 | 300 | 10 | 50 | 400 |
| FDCW2012-2-161TF | 160 | 350 | 10 | 50 | 350 |
| FDCW2012-2-181TF | 180 | 350 | 10 | 50 | 350 |
| FDCW2012-2-201TF | 200 | 350 | 10 | 50 | 300 |
| FDCW2012-2-221TF | 220 | 350 | 10 | 50 | 300 |
| FDCW2012-2-251TF | 250 | 400 | 10 | 50 | 300 |
| FDCW2012-2-261TF | 260 | 400 | 10 | 50 | 300 |
| FDCW2012-2-301TF | 300 | 400 | 10 | 50 | 290 |
| FDCW2012-2-361TF | 360 | 400 | 10 | 50 | 300 |
| FDCW2012-2-371TF | 370 | 450 | 10 | 50 | 280 |
| FDCW2012-2-481TF | 480 | 550 | 10 | 50 | 200 |
| FDCW2012-2-501TF | 500 | 550 | 10 | 50 | 200 |
| FDCW2012-2-601TF | 600 | 550 | 10 | 50 | 300 |
| FDCW2012-2-671TF | 670 | 600 | 10 | 50 | 180 |
| FDCW2012-2-681TF | 680 | 700 | 10 | 50 | 180 |
| FDCW2012-2-751TF | 750 | 800 | 10 | 50 | 150 |
| FDCW2012-2-801TF | 800 | 1000 | 10 | 50 | 300 |
| FDCW2012-2-901TF | 900 | 1000 | 10 | 50 | 100 |
| FDCW2012-2-102TF | 1000 | 1000 | 10 | 50 | 100 |

Notes

1. All test data is referenced to 25 °C ambient.
2. Operating temperature range - 40 °C to + 85 °C.
3. I_{rms} (A):DC current (A) that will cause an approximate ΔT of 40 °C(reference ambient temperature is 25 °C).
4. The part temperature (ambient + temp rise) should not exceed 125 °C under worst case operating conditions.
Circuit design, component placement, PWB trace size and thickness, airflow and other cooling provisions.
all affect the part temperature. Part temperature should be verified in the end application.

9. Typical impedance vs. frequency

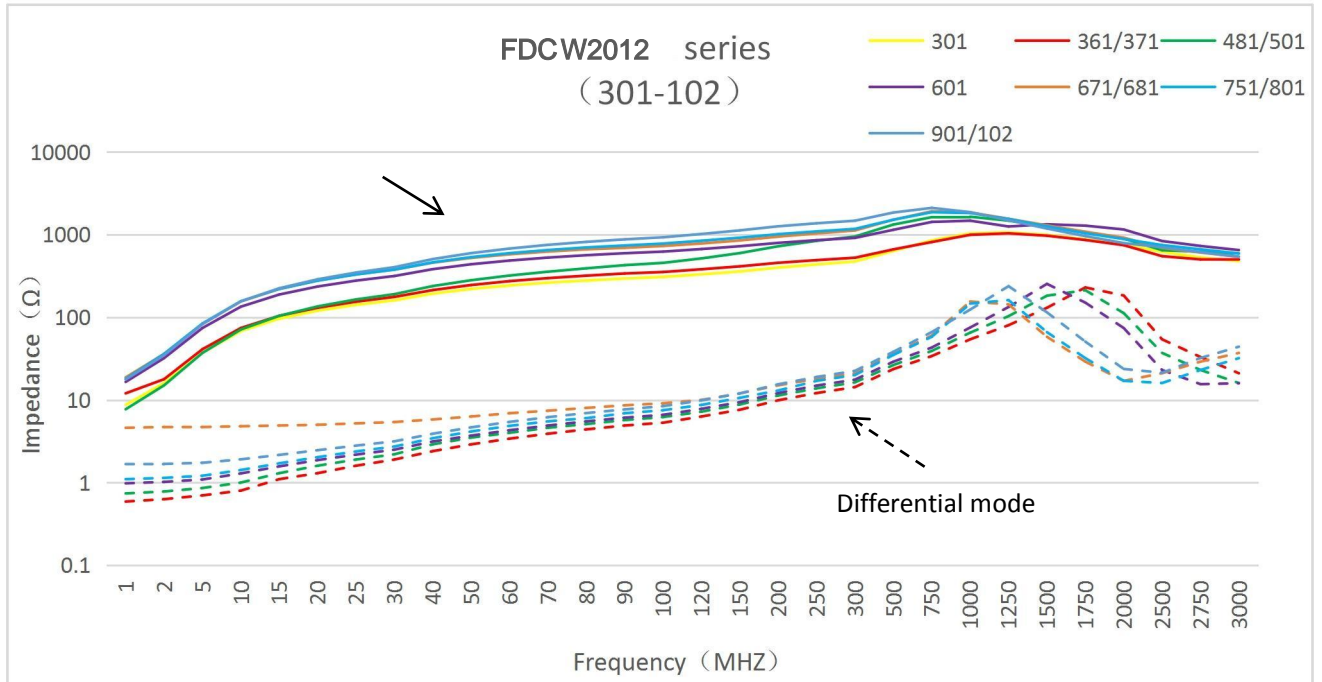
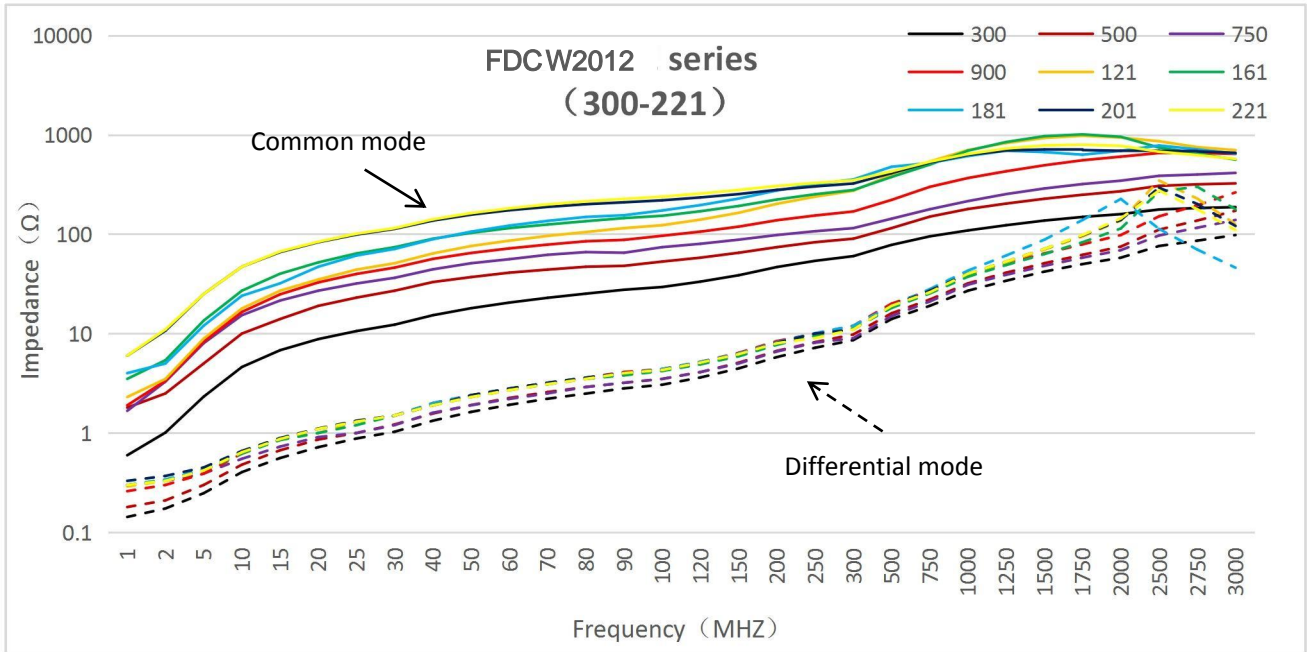

10. Reliability Test

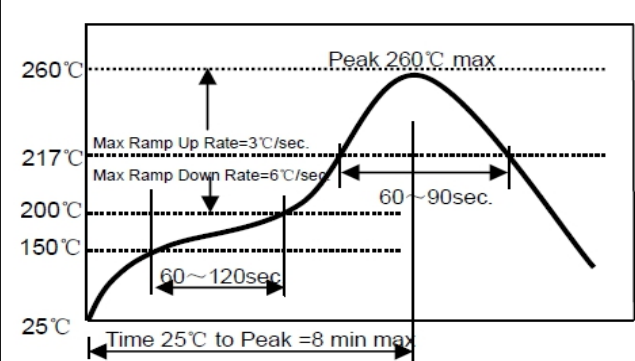
| Items | Requirements | Test Methods and Remarks |
|---|---|---|
| Operating life | 1. No visible mechanical damage 2. Impedance change: Within $\pm 20\%$ 3. Insulation resistance: 10M Ω min | 1. Reflow 2 times 2. temperature: 155 ± 2 °C |
| Resistance to Soldering Heat | 1. No visible mechanical damage 2. Impedance change: Within $\pm 20\%$ | 1. Solder on PCB to Reflow test Peak Temp. 260 ± 5 °C 5~10 secs ,Cycles :2 times..Re-flowing Profile: Please refer to Fig-1 2. Test board thickness: 1.5mm 3. Test board material: glass epoxy resin 4. The specimen shall be stored at standard atmospheric conditions for 1 hour, after which the measurement shall be made.product showed no damage under microscope. |
| Fig-1 | | |
|  | | |
| High Temperature | 1. No visible mechanical damage 2. Impedance change: Within $\pm 20\%$ 3. Insulation resistance: 10M Ω min | 1. Temperature: 125 ± 2 °C 2. Duration: 1000 hours The specimen shall be stored at standard atmospheric conditions for 1 hour, after which the measurement shall be made. |
| Steady damp-heat | 1. No visible mechanical damage 2. Impedance change: Within $\pm 20\%$ 3. Insulation resistance: 10M Ω min | 1. Temperature:85°C 2. Humidity: 85% RH 3. Duration:1000 hours 4. The specimen shall be stored at standard atmospheric conditions for 1 hour, after which the measurement shall be made. |
| Mechanical Vibration | 1. No visible mechanical damage 2. Impedance change: Within $\pm 20\%$ | 1. Frequency: 10HZ~55HZ~10HZ/Min Cycles 2. Amplitude: 1.5 mm 3. Directions: X,Y,Z 4. Time: 2 hours in each directions (total of 6 hours) |

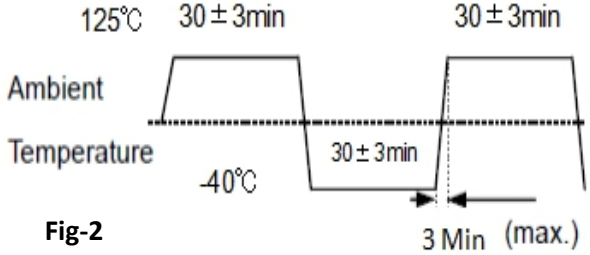
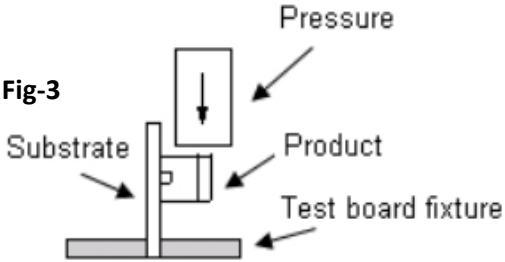
| Items | Requirements | Test Methods and Remarks |
|-------------------|--|--|
| Thermal Shock | 1. No visible mechanical damage 2. Impedance change: Within $\pm 20\%$ 3. Insulation resistance: $10M\Omega$ min | 1. Temperature and time: -40°C for 30 ± 3 min \rightarrow 125°C for 30 ± 3 min, please refer to Fig-2 2. Transforming interval: Max. 3 Min 3. Tested cycle: 1000 cycles 4. The specimen shall be stored at standard atmospheric conditions for 1 hour, after which the measurement shall be made.  <p>Fig-2</p> |
| Salt Spray | 1. No visible mechanical damage 2. Impedance change: Within $\pm 20\%$ | 1. Salt concentration: $(5 \pm 1)\%$ (mass percent) 2. pH value: 6.5 - 7.2 3. temperature: $35 \pm 2^{\circ}\text{C}$ 4. humidity: 85% 5. time: 24 hours 6. in normal temperature and humidity for 1 ~ 2 hours, testing inductance, the inductance value change can not be more than before test $\pm 10\%$. |
| Terminal strength | No visible mechanical damage | 1. The electrode of the inductor is soldered to the PCB, to Fig-3 Then apply a force in the direction of the arrow. 2. 5N force. 3. Keep time: $10(\pm 1)\text{s}$ The first three tests were OK, and the force was applied until the peak value of the product peeling. The test speed was set in the range of $3 \sim 8\text{mm/min}$.  <p>Fig-3</p> |

11 . Packaging Information

1) Tape Packaging Dimensions

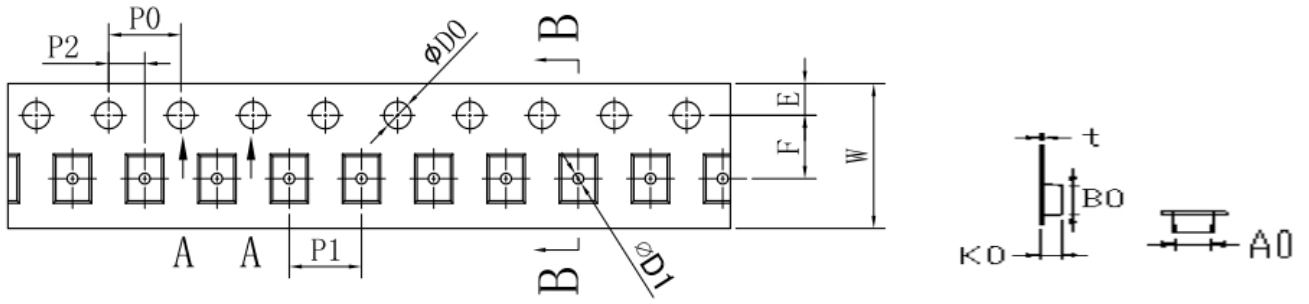

(Unit: mm)

| Type | W | P1 | A0 | B0 | K0 | t | E | F | P2 | D0 | D1 | P0 |
|-----------|--------------------|--------------------|--------------------|--------------------|--------------------|--------------------|--------------------|--------------------|--------------------|--------------------|--------------------|--------------------|
| FDCW 2012 | 8.00 ± 0.10 | 4.00 ± 0.10 | 1.50 ± 0.10 | 2.30 ± 0.10 | 1.45 ± 0.10 | 0.20 ± 0.05 | 1.75 ± 0.10 | 3.50 ± 0.10 | 2.00 ± 0.10 | 1.55 ± 0.05 | 0.80 ± 0.05 | 4.00 ± 0.10 |

2) Leader and blank portion

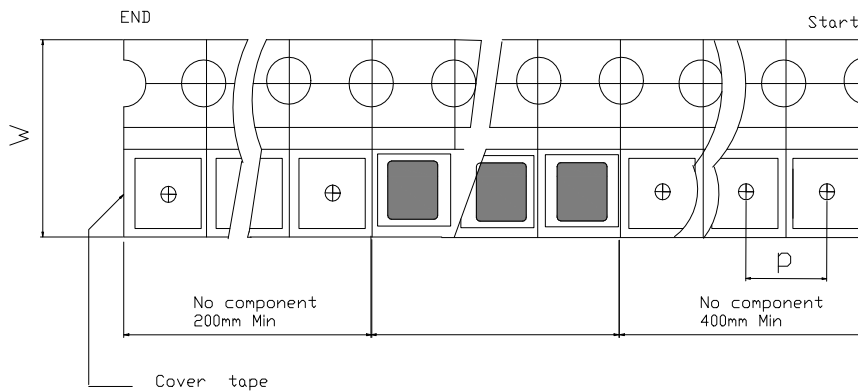

3) Taping Drawings

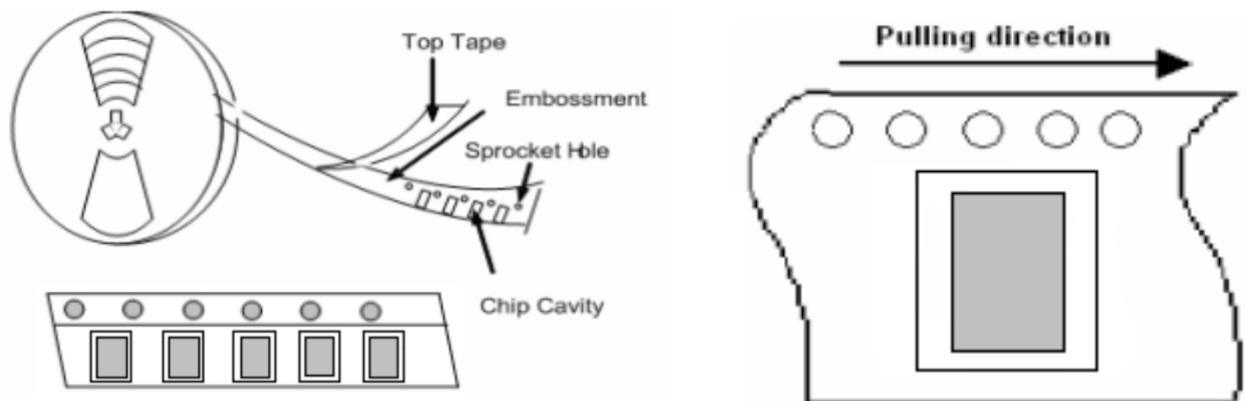

4) Reel Dimensions (Unit: mm)

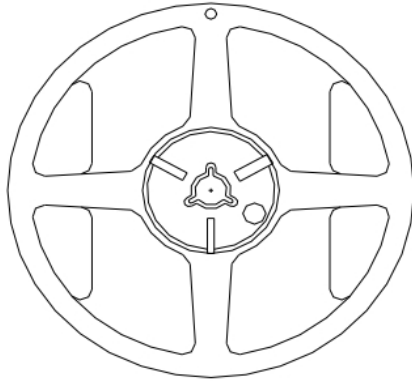
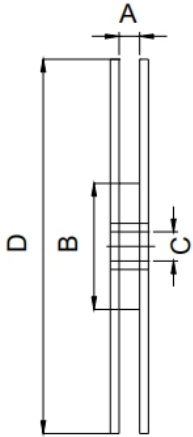

| | |
|--------|-------------|
| A (mm) | 9.50 ± 1.0 |
| B (mm) | 60.0 ± 1.0 |
| C (mm) | 13.0 ± 0.2 |
| D (mm) | 178.0 ± 1.0 |

5) Packaging Quantity

| Type | Standard Quantity | | |
|----------|-------------------|-------------------------|----------------------------------|
| | Reel | Inner box | Carton box |
| FDCW2012 | 2000 pcs / reel | 5Reel / box (10000 pcs) | 10 Middle boxes, (100000 pcs) |

6) Peel force of top cover tape

The peel speed shall be about 300mm/minute.

The peel force of top cover tape shall be between 10 to 100gf.

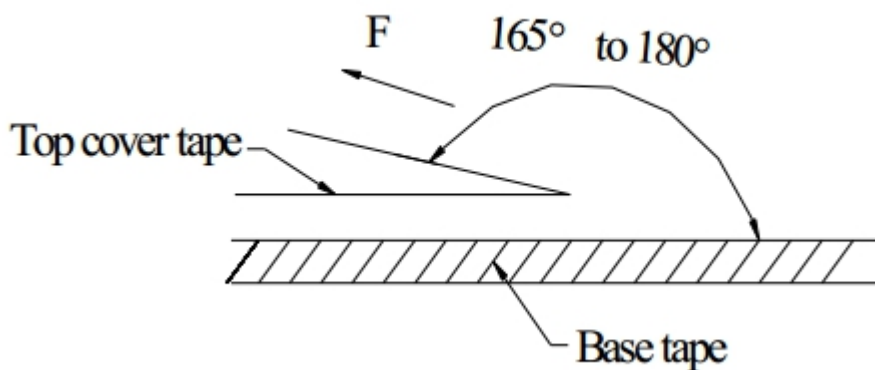

7) Reel Label

- Label on the reel
 - Customer's part Number
 - Lot Number
 - Quantity
 - date code

- Shipping Label
 - Customer's part Number
 - Manufacturer's part Number
 - Quantity
 - date code

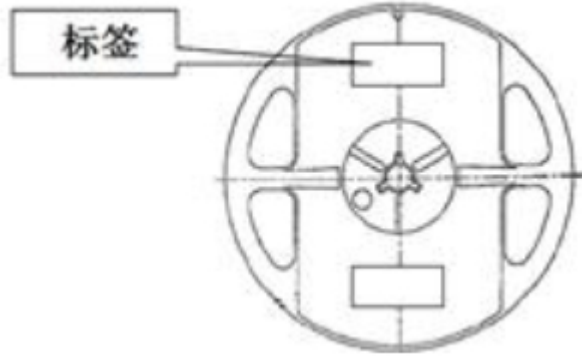

8) Inner Box

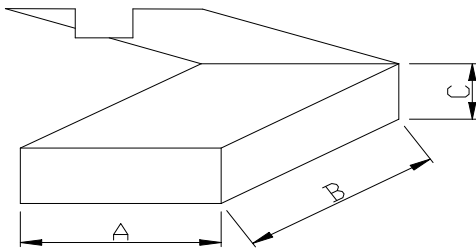

| Packaging Type | A (mm) | B (mm) | C (mm) |
|----------------|--------|--------|--------|
| Inner box | 188 | 195 | 67 |

9) Carton

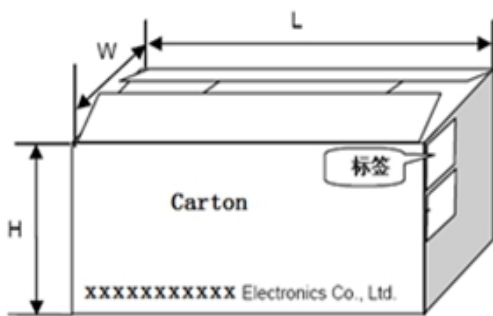

| Packaging Type | L (mm) | W (mm) | H (mm) |
|----------------|--------|--------|--------|
| Carton | 390 | 350 | 215 |

X-ON Electronics

Largest Supplier of Electrical and Electronic Components

Click to view similar products for [Common Mode Chokes / Filters](#) *category:*

Click to view products by [Changjiang Microelectronics](#) *manufacturer:*

Other Similar products are found below :

[PE-64683](#) [RD5122-6-9M6](#) [RD6137-6-7M5](#) [RD8147-16-3M0](#) [ST6118T-R](#) [FE3X025-10-7NL](#) [RD7147-25-0M7](#) [TCM0806G-350-2P-T](#)
[TCM0806G-650-2P-T](#) [IND-0110](#) [UAL21VR0802000](#) [UALSC023000000](#) [UALSC1020JH000](#) [UALSU10VD20010](#) [UALSU9VD070100](#) [36-00037](#) [UALW21HS072450](#) [UALSU9H0208000](#) [UAL24VK06450CH](#) [PLT10HH501100PNB](#) [PLT10HH401100PNB](#) [PLT10HH1026R0PNB](#)
[36-00029-01](#) [PE-67531](#) [TLH10UB](#) [113 0R5](#) [2752045447](#) [7351V](#) [CMF16-153131](#) [RD7147-6-6M0](#) [T8116NLT](#) [FE2X10-4-2NL](#) [36-00029-07](#)
[T8003NLT](#) [CTX01-13663](#) [CTX66-19521-R](#) [RC212-0.5-10M](#) [RC112-0.4-15M](#) [RC212-0.6-6M8](#) [RC212-0.4-15M](#) [RC112-0.3-30M](#)
[WTCF2012Z0M751PB](#) [PH9408.814NLT](#) [PAC6006.364NLT](#) [PAC6006.444NLT](#) [PAC6006.204NLT](#) [PH9407.204NLT](#) [PAC6006.264NLT](#)
[PH9408.105NLT](#) [PH9408.494NLT](#) [PAC6006.104NLT](#)