

Specification for Approval

| | |
|----------------------|---------------------------------------|
| Customer | |
| Product Name | Wire Wound Molded SMD Power Inductors |
| Customer Cjiang P/N: | |
| Cjiang P/N: | FEXL series |

New Released, Revised] SPEC No.:

| | | |
|----------------------------|--|--|
| REMARK: | | |
| | | |
| Customer Approval Feedback | | |
| | | |

● 深圳市长江微电科技有限公司

SZ CJIANG TECHNOLOGY CO.,LTD

ADD: 11F, International Science and Technology Building, Fuhong Road, Futian District, Shenzhen

Factory ADD: No. shanyang RD CJIANG Industrial Park HUAI'AN Section HUAI'AN City Jiangsu Province

TEL: 0755-82529562 FAX:0755-83977004

<http://www.CJING.COM.CN>

E-mail: BOND@Cjiang.com.cn; ann@cjiang.com.cn

Version change history

| Rev | Date | Description | APPROVED | CHECKED | DRAWN |
|-----|------------|----------------------|----------|---------|---------|
| 1.0 | 2023/11/17 | Document formulation | 徐舒霞 | 马月 | 朱小娟 |
| 2.0 | 2024/3/25 | Merge all sizes | BOND | XUETING | XUETING |

Caution :

All products listed in this specification are developed, designed and intended for use in general electronics equipment. The products are not designed or Warranted to meet the requirements of the applications listed below, whose performance and/or quality require especially high reliability, or whose failure, malfunction or trouble might directly cause damage to society, person, or property. Please understand that we are not responsible for any damage or liability caused by use of the products in any of the applications below. Please contact us for more details if you intend to use our products in the following applications.

1. Aircraft equipment.
2. Aerospace equipment.
3. Undersea equipment.
4. nuclear control equipment.
5. military equipment.
6. Power plant equipment.
7. Medical equipment.
8. Transportation equipment (automobiles, trains, ships,etc.)
9. Traffic signal equipment.
10. Disaster prevention / crime prevention equipment.
11. Data-processing equipment.
12. Applications of similar complexity or with reliability requirements comparable to the applications listed in the above.



Introduction

- Soft saturation.
- High current , low DCR , high efficiency.
- Very low acoustic noise and very low leakage flux noise.
- High reliability.
- 100% Lead(Pb)-Free and RoHS compliant.
- Operating temperature -55~+125 °C (Including self -temperature rise)



Applications

- Note PC power system , incl. IMVP-6
- DC/DC converter

Dimensions (Unit: mm)



| Code | Dimensions(mm) |
|------|-----------------|
| A | 8.9±0.3 |
| B | 8.5±0.3 |
| C | 7.7±0.3 |
| D | See Spec table |
| E | 1.8±0.3 |
| F | 3.5±0.5 |



| | |
|---|---------|
| L | 10.5ref |
| H | 11.0ref |
| G | 3.7ref |

Recommend Land Pattern

Unit : mm

| series | A | B | C | D | E | F | L | H | G |
|-----------|----------|----------|----------|----------------|----------|----------|---------|---------|--------|
| FEXL0420A | 4.1±0.2 | 4.1±0.2 | 1.9±0.2 | 3.4±0.3 | 0.88±0.3 | 1.7±0.3 | 3.4ref | 3.8ref | 1.4ref |
| FEXL0430A | 4.1±0.25 | 4.1±0.25 | 2.8±0.2 | 3.4±0.3 | 0.88±0.3 | 1.7±0.3 | 3.4ref | 3.8ref | 1.4ref |
| FEXL0520A | 5.5±0.2 | 5.3±0.2 | 1.9±0.2 | 4.3±0.3 | 1.1±0.3 | 2.3±0.3 | 4.5ref | 4.7ref | 2.0ref |
| FEXL0530A | 5.5±0.2 | 5.3±0.2 | 2.9±0.2 | 4.3±0.3 | 1.1±0.3 | 2.3±0.3 | 4.5ref | 4.7ref | 2.0ref |
| FEXL0550A | 5.5±0.2 | 5.3±0.2 | 4.8±0.2 | 4.3±0.3 | 1.1±0.3 | 2.3±0.3 | 4.5ref | 4.7ref | 2.0ref |
| FEXL0630A | 6.6±0.2 | 6.4±0.2 | 2.9±0.2 | See Spec table | 1.4±0.3 | 2.6±0.3 | 5.6ref | 5.6ref | 2.5ref |
| FEXL0650A | 6.6±0.2 | 6.4±0.2 | 4.8±0.2 | See Spec table | 1.4±0.3 | 2.6±0.3 | 5.6ref | 5.6ref | 2.5ref |
| FEXL0660A | 6.6±0.2 | 6.4±0.2 | 5.8±0.2 | 5.3±0.3 | 1.4±0.3 | 2.6±0.3 | 5.6ref | 5.6ref | 2.5ref |
| FEXL0720A | 7.8±0.25 | 7.6±0.2 | 1.85±0.2 | See Spec table | 1.75±0.3 | 3.15±0.3 | 7.4ref | 7.2ref | 2.8ref |
| FEXL0730A | 7.8±0.25 | 7.6±0.2 | 2.9±0.2 | See Spec table | 1.75±0.3 | 3.15±0.3 | 7.4ref | 7.2ref | 2.8ref |
| FEXL0770A | 7.8±0.25 | 7.6±0.25 | 6.7±0.3 | See Spec table | 1.75±0.3 | 3.15±0.3 | 7.8ref | 6.7ref | 2.8ref |
| FEXL0880A | 8.9±0.3 | 8.5±0.3 | 7.7±0.3 | See Spec table | 1.8±0.3 | 3.5±0.5 | 8.0ref | 7.8ref | 2.7ref |
| FEXL1010A | 11.9±0.3 | 11.0±0.3 | 9.7±0.3 | See Spec table | 2.4±0.3 | 4.4±0.5 | 10.5ref | 11.0ref | 3.7ref |
| FEXL1031A | 11.9±0.3 | 11.0±0.3 | 2.9±0.2 | 9.0±0.5 | 2.4±0.3 | 4.4±0.5 | 10.5ref | 11.0ref | 3.7ref |
| FEXL1060A | 11.9±0.3 | 11.0±0.3 | 5.7±0.3 | See Spec table | 2.4±0.3 | 4.5±0.5 | 10.5ref | 11.0ref | 3.7ref |
| FEXL1580A | 16.5±0.3 | 15.5±0.3 | 7.7±0.3 | 13.2±0.5 | 3.2±0.3 | 7.0±0.5 | 15.0ref | 15.0ref | 6.0ref |
| FEXL1510A | 16.5±0.3 | 15.5±0.3 | 9.7±0.3 | 13.2±0.5 | 3.2±0.3 | 7.0±0.3 | 15.0ref | 15.0ref | 6.0ref |
| FEXL1513A | 16.5±0.3 | 15.5±0.3 | 12.7±0.3 | 13.2±0.5 | 3.2±0.3 | 7.0±0.5 | 15.0ref | 15.0ref | 6.0ref |

Marking

Note : Using Ink for marking



Marking:

| Example | Nominal Value |
|--------------|---------------|
| 0.18 μ H | R18 |
| 1.2 μ H | 1R2 |
| 4.5 μ H | 4R5 |

Structure and Componen

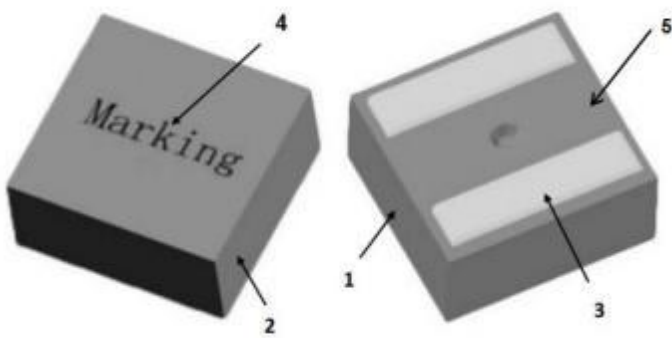

| NO | Components | Material |
|----|------------|-------------------------------|
| 1 | CORE | Alloy Powder |
| 2 | WIRE | Polyester Wire or equivalent. |
| 3 | Clip | 100% Pb free solder |
| 4 | Ink | Halogen-free ketone |
| 5 | paint | Epoxy resin |

Appendix A: Electrical Characteristics

FEXL0420A series

| Part No. | L0 (μH)±20 % | DCR (mΩ) MAX | Isat (A) | | Irms (A)Typ | |
|----------------|--------------|------------------|----------|------|-------------|-------------|
| | | | Max | Typ | 20℃ rise | 40℃ rise |
| FEXL0420A-R10M | 0.1 | 2.42 | 33 | 38 | 13.5 | 18 |
| FEXL0420A-R22M | 0.22 | 4.6 | 18.8 | 19.5 | 13.0 | 16.8 |
| FEXL0420A-R36M | 0.36 | 6.3 | 15 | 17 | 11 | 14.5 |
| FEXL0420A-R40M | 0.4 | 7.73 | 13.5 | 15.5 | 10 | 14 |
| FEXL0420A-R47M | 0.47 | 8.58 | 13 | 14.5 | 9 | 12.5 |
| FEXL0420A-R56M | 0.56 | 9.3 | 12.6 | 14 | 8.5 | 12 |
| FEXL0420A-R60M | 0.6 | 9.52 | 12.3 | 13.7 | 8.0 | 11.7 |
| FEXL0420A-R68M | 0.68 | 11.2 | 10.9 | 12.3 | 7.8 | 10.7 |
| FEXL0420A-R72M | 0.72 | 11.6 | 10.6 | 12 | 7.6 | 10.5 |
| FEXL0420A-1R0M | 1.0 | 14.6 | 8.8 | 9.6 | 6.8 | 9.6 |
| FEXL0420A-1R2M | 1.2 | 17.9 | 7.8 | 9 | 6.6 | 9.0 |
| FEXL0420A-1R5M | 1.5 | 23.5 | 7.4 | 8 | 5.8 | 7.6 |
| FEXL0420A-1R8M | 1.8 | 28 | 7 | 7.5 | 5.2 | 7 |
| FEXL0420A-2R2M | 2.2 | 38.7 | 6 | 6.5 | 4.6 | 5.6 |

FEXL0430A series

| Part No. | L0 (μH)±20 % | DCR (mΩ) MAX | Isat (A) | | Irms (A)Typ | |
|----------------|--------------|------------------|----------|------|-------------|-------------|
| | | | Max | Typ | 20℃ rise | 40℃ rise |
| FEXL0430A-R47M | 0.47 | 7.26 | 15 | 17 | 10 | 14 |
| FEXL0430A-R90M | 0.90 | 10.1 | 9.0 | 10.0 | 8.2 | 11.2 |
| FEXL0430A-1R0M | 1.00 | 10.1 | 9.2 | 9.8 | 8.0 | 11.0 |
| FEXL0430A-1R2M | 1.20 | 11.5 | 8.7 | 9.2 | 7.8 | 9.8 |
| FEXL0430A-1R5M | 1.50 | 13.2 | 7.0 | 8.0 | 7.0 | 9.0 |
| FEXL0430A-2R2M | 2.20 | 22.6 | 6.1 | 7.0 | 6.0 | 7.8 |
| FEXL0430A-3R3M | 3.30 | 28.6 | 5.3 | 6.2 | 5.0 | 6.6 |
| FEXL0430A-4R7M | 4.7 | 44.1 | 4.0 | 4.5 | 3.9 | 5.1 |
| FEXL0430A-6R8M | 6.8 | 74.1 | 3.0 | 3.6 | 3.0 | 3.9 |

FEXL0520A series

| Part No. | L0 (μH)±20 % | DCR (mΩ) MAX | Isat (A) | | Irms (A)Typ | |
|----------------|--------------|------------------|----------|------|-------------|-------------|
| | | | Max | Typ | 20℃ rise | 40℃ rise |
| FEXL0520A-R15M | 0.15 | 4.60 | 27.0 | 30.0 | 13.9 | 18.8 |
| FEXL0520A-R16M | 0.16 | 4.60 | 27.0 | 30.0 | 13.9 | 18.8 |
| FEXL0520A-R33M | 0.33 | 7.00 | 24.0 | 26.0 | 10.5 | 14.4 |
| FEXL0520A-R47M | 0.47 | 8.05 | 20.0 | 22.0 | 10.1 | 14.1 |
| FEXL0520A-R56M | 0.56 | 9.54 | 16.0 | 19.0 | 9.9 | 13.9 |
| FEXL0520A-R68M | 0.68 | 10.2 | 14.0 | 16.0 | 9.6 | 13.4 |
| FEXL0520A-R80M | 0.8 | 11.8 | 13.5 | 15.5 | 9.4 | 13.0 |
| FEXL0520A-R82M | 0.82 | 12.7 | 13.0 | 15.0 | 8.5 | 12.0 |
| FEXL0520A-1R0M | 1.0 | 13.8 | 12.8 | 14.5 | 7.5 | 10.5 |
| FEXL0520A-1R2M | 1.2 | 16.3 | 12.2 | 14.0 | 6.8 | 9.40 |
| FEXL0520A-1R5M | 1.5 | 18.7 | 11.7 | 13.3 | 6.4 | 8.80 |

FEXL0530A series

| Part No. | L0 (μH)±20 % | DCR (mΩ) MAX | Isat (A) | | Irms (A)Typ | |
|----------------|--------------|------------------|----------|------|-------------|-------------|
| | | | Max | Typ | 20℃ rise | 40℃ rise |
| FEXL0530A-R15M | 0.15 | 2.31 | 32.5 | 36 | 14.3 | 22.2 |
| FEXL0530A-R16M | 0.16 | 2.33 | 32 | 35 | 14.2 | 22.2 |
| FEXL0530A-R33M | 0.33 | 3.52 | 26 | 28 | 13.8 | 19.2 |
| FEXL0530A-R47M | 0.47 | 4.13 | 24 | 26 | 13.7 | 18.4 |
| FEXL0530A-R56M | 0.56 | 4.52 | 20.2 | 22.2 | 13.6 | 17.7 |
| FEXL0530A-R60M | 0.6 | 4.52 | 20 | 22 | 13.6 | 17.7 |
| FEXL0530A-R80M | 0.8 | 5.65 | 18 | 20 | 10.1 | 13.1 |
| FEXL0530A-R82M | 0.82 | 5.78 | 17.6 | 19.7 | 9.9 | 12.9 |
| FEXL0530A-1R0M | 1.0 | 7.6 | 14.3 | 16.5 | 9 | 12.2 |
| FEXL0530A-1R2M | 1.2 | 9.7 | 13.5 | 15 | 8.5 | 11 |
| FEXL0530A-1R5M | 1.5 | 11.2 | 12.5 | 14 | 8 | 10.5 |
| FEXL0530A-1R8M | 1.8 | 12.7 | 11.3 | 12.3 | 7.6 | 10.1 |
| FEXL0530A-2R2M | 2.2 | 14.5 | 9 | 10 | 7.2 | 9.7 |
| FEXL0530A-3R3M | 3.3 | 23.1 | 8.7 | 9.5 | 5.9 | 8.1 |
| FEXL0530A-4R7M | 4.7 | 36.3 | 7 | 8.2 | 4.3 | 5.9 |

FEXL0550A series

| Part No. | L0 (μH)±20 % | DCR (mΩ) MAX | Isat (A) | | Irms (A)Typ | |
|----------------|--------------|-----------------|----------|-----|-------------|-----------|
| | | | Max | Typ | 20°C rise | 40°C rise |
| FEXL0550A-4R7M | 4.7 | 21 | / | 8.8 | / | 8.1 |
| FEXL0550A-5R6M | 5.6 | 24.2 | 7.2 | 8.6 | 5.3 | 7.2 |
| FEXL0550A-6R8M | 6.8 | 28.6 | 6.6 | 7.8 | 4.8 | 6.4 |
| FEXL0550A-8R2M | 8.2 | 32.5 | 6.1 | 7.2 | 4.6 | 6.1 |
| FEXL0550A-100M | 10 | 43 | 5.4 | 6.5 | 3.8 | 5 |
| FEXL0550A-150M | 15 | 76.7 | 3.2 | 3.7 | 3 | 3.9 |
| FEXL0550A-220M | 22 | 99.65 | 3 | 3.6 | 2.5 | 3.4 |

FEXL0630A series

| Part No. | L0 (μH)±20 % | DCR (mΩ) MAX | Isat (A) | | Irms (A)Typ | | D(mm) ±0.3 |
|----------------|--------------|-----------------|----------|------|-------------|-----------|---------------|
| | | | MAX | Typ | 20°C rise | 40°C rise | |
| FEXL0630A-R18M | 0.18 | 1.75 | 36.0 | 40.0 | 24.0 | 32.0 | 5.30 |
| FEXL0630A-R33M | 0.33 | 2.50 | 28.0 | 32.0 | 20.0 | 25.0 | 5.55 |
| FEXL0630A-R56M | 0.56 | 3.31 | 25.0 | 29.0 | 17.0 | 22.0 | 5.30 |
| FEXL0630A-R68M | 0.68 | 5.17 | 21.0 | 25.0 | 15.0 | 20.0 | 5.30 |
| FEXL0630A-1R0M | 1.0 | 6.05 | 18.0 | 23.0 | 13.0 | 18.0 | 5.20 |
| FEXL0630A-1R2M | 1.2 | 7.40 | 16.0 | 22.0 | 12.0 | 16.0 | 5.15 |
| FEXL0630A-1R5M | 1.5 | 9.13 | 15.5 | 20.0 | 11.0 | 15.0 | 5.15 |
| FEXL0630A-1R8M | 1.8 | 10.2 | 13.0 | 18.2 | 10.0 | 14.0 | 5.10 |
| FEXL0630A-2R2M | 2.2 | 12.2 | 11.0 | 15.9 | 7.00 | 10.0 | 5.05 |
| FEXL0630A-3R3M | 3.3 | 20.8 | 9.00 | 12.2 | 6.00 | 8.00 | 5.00 |
| FEXL0630A-4R5M | 4.5 | 25.3 | 8.00 | 10.0 | 5.00 | 7.00 | 5.00 |

FEXL0650A series

| Part No. | L0 (μH)±20 % | DCR (mΩ) MAX | Isat (A) | | Irms (A)Typ | | D(mm) ±0.3 |
|----------------|--------------|-----------------|----------|------|-------------|-----------|---------------|
| | | | MAX | Typ | 20°C rise | 40°C rise | |
| FEXL0650A-R82M | 0.82 | 4.18 | 20.0 | 24.0 | 16.0 | 21.0 | 5.3 |
| FEXL0650A-1R0M | 1.0 | 4.52 | 18.0 | 23.0 | 15.0 | 20.0 | 5.3 |
| FEXL0650A-1R2M | 1.2 | 5.83 | 16.0 | 22.0 | 14.0 | 18.0 | 5.3 |

| | | | | | | | |
|----------------|-----|------|------|------|------|------|-----|
| FEXL0650A-1R5M | 1.5 | 6.3 | 14.5 | 19.5 | 13.0 | 17.0 | 5.3 |
| FEXL0650A-1R8M | 1.8 | 7.1 | 13.5 | 18.5 | 12.0 | 16.0 | 5.3 |
| FEXL0650A-2R2M | 2.2 | 8.5 | 12.0 | 16.0 | 10.0 | 13.0 | 5.2 |
| FEXL0650A-3R3M | 3.3 | 12.5 | 10.0 | 12.5 | 8.5 | 11.0 | 5.2 |
| FEXL0650A-4R3M | 4.3 | 16.2 | 8.5 | 11.0 | 7.0 | 9.0 | 5.2 |
| FEXL0650A-4R7M | 4.7 | 18.4 | 8.0 | 10.5 | 6.5 | 8.5 | 5.2 |

FEXL0660A series

| Part No. | L0 (μ H) \pm 20 % | DCR (m Ω) MAX | Isat (A) | | Irms (A)Typ | |
|----------------|--------------------------|--------------------------|----------|------|-------------------------|-------------------------|
| | | | Max | Typ | 20 $^{\circ}$ C rise | 40 $^{\circ}$ C rise |
| FEXL0660A-1R0M | 1.0 | 4.4 | 19.0 | 24.0 | 16.0 | 21.0 |
| FEXL0660A-1R5M | 1.5 | 6.1 | 15.0 | 20.0 | 13.5 | 17.5 |
| FEXL0660A-2R2M | 2.2 | 8.1 | 12.5 | 16.5 | 11.0 | 14.0 |
| FEXL0660A-3R3M | 3.3 | 12.3 | 11.0 | 13.0 | 9.0 | 12.0 |
| FEXL0660A-4R7M | 4.7 | 14.4 | 9.3 | 10.5 | 8.5 | 11.0 |
| FEXL0660A-5R6M | 5.6 | 15.9 | 8.7 | 9.9 | 7.6 | 10.0 |
| FEXL0660A-6R8M | 6.8 | 20.8 | 8.1 | 9.2 | 7.0 | 9.0 |
| FEXL0660A-8R2M | 8.2 | 26.4 | 8 | 8.4 | 6 | 8 |
| FEXL0660A-100M | 10 | 29.82 | 6.8 | 7.6 | 5 | 7 |
| FEXL0660A-150M | 15 | 43.75 | 5 | 5.8 | 4.5 | 6 |
| FEXL0660A-220M | 22 | 60.63 | 4.8 | 5.6 | 3.8 | 5 |
| FEXL0660A-330M | 33 | 105.0 | 2.5 | 3.7 | 2.3 | 3.6 |

FEXL0720A series

| Part No. | L0 (μ H) \pm 20 % | DCR (m Ω) MAX | Isat (A) | | Irms (A)Typ | | D(mm) \pm 0.3 |
|----------------|--------------------------|--------------------------|----------|-----|-------------------------|-------------------------|--------------------|
| | | | MAX | Typ | 20 $^{\circ}$ C rise | 40 $^{\circ}$ C rise | |
| FEXL0720A-R27M | 0.27 | 3.5 | 32 | 35 | 16 | 21 | 6.6 |
| FEXL0720A-R31M | 0.31 | 4.8 | 31 | 34 | 14 | 20 | 6.2 |
| FEXL0720A-R33M | 0.33 | 4.8 | 31 | 34 | 13 | 19 | 6.2 |
| FEXL0720A-R47M | 0.47 | 6.2 | 25 | 28 | 12 | 17 | 6.2 |
| FEXL0720A-R68M | 0.68 | 9.2 | 23 | 25 | 10 | 13 | 6.2 |
| FEXL0720A-1R0M | 1.00 | 10.8 | 20 | 23 | 8.0 | 11 | 6.2 |

FEXL0730A series

| Part No. | L0 (μH)±20 % | DCR (mΩ) MAX | Isat (A) | | Irms (A)Typ | | D(mm) ±0.3 |
|----------------|--------------|------------------|----------|------|-------------|-------------|---------------|
| | | | MAX | Typ | 20℃ rise | 40℃ rise | |
| FEXL0730A-1R0M | 1.00 | 5.00 | 28.0 | 30.0 | 16.1 | 21.8 | 6.6 |
| FEXL0730A-1R5M | 1.50 | 8.25 | 23.5 | 25.0 | 12.0 | 15.3 | 6.6 |
| FEXL0730A-2R2M | 2.20 | 13.7 | 17.0 | 19.0 | 10.0 | 13.0 | 6.2 |
| FEXL0730A-2R7M | 2.70 | 15.4 | 13.5 | 16.0 | 9.20 | 11.4 | 6.2 |
| FEXL0730A-3R3M | 3.30 | 18.0 | 13.0 | 15.0 | 8.00 | 10.0 | 6.2 |
| FEXL0730A-4R7M | 4.70 | 26.7 | 12.2 | 13.5 | 6.90 | 9.00 | 6.2 |
| FEXL0730A-5R6M | 5.60 | 33.2 | 11.5 | 12.5 | 5.30 | 7.30 | 6.2 |
| FEXL0730A-6R8M | 6.80 | 42.5 | 11.0 | 12.0 | 4.50 | 6.80 | 6.2 |
| FEXL0730A-8R2M | 8.20 | 48.73 | 9.0 | 10.2 | 3.00 | 5.90 | 6.2 |

FEXL0770A series

| Part No. | L0 (μH)±20 % | DCR (mΩ) MAX | Isat (A) | | Irms (A)Typ | | D(mm) ±0.3 |
|----------------|--------------|------------------|----------|------|-------------|-------------|---------------|
| | | | MAX | Typ | 20℃ rise | 40℃ rise | |
| FEXL0770A-3R3M | 3.30 | 9.42 | 15.1 | 19.4 | 11.5 | 15.1 | 6.70 |
| FEXL0770A-4R7M | 4.70 | 13.5 | 14.0 | 15.5 | 10.5 | 13.6 | 6.70 |
| FEXL0770A-6R8M | 6.80 | 19.60 | 11.0 | 12.8 | 7.0 | 9.5 | 6.50 |

FEXL0880A series

| Part No. | L0 (μH)±20 % | DCR (mΩ) MAX | Isat (A) | | Irms (A)Typ | | D(mm) ±0.3 |
|----------------|--------------|------------------|----------|------|-------------|-------------|---------------|
| | | | MAX | Typ | 20℃ rise | 40℃ rise | |
| FEXL0880A-1R8M | 1.80 | 4.0 | 24.0 | 28.0 | 18.0 | 24.0 | 7.2 |
| FEXL0880A-2R2M | 2.20 | 4.3 | 22.0 | 25.0 | 16.0 | 21.5 | 7.2 |
| FEXL0880A-3R3M | 3.30 | 7.3 | 20.0 | 23.0 | 13.5 | 18.0 | 6.9 |
| FEXL0880A-4R7M | 4.70 | 9.8 | 17.0 | 19.0 | 10.5 | 14.6 | 6.9 |
| FEXL0880A-6R8M | 6.80 | 14.3 | 12.5 | 14.5 | 8.0 | 11.3 | 6.9 |
| FEXL0880A-100M | 10.0 | 22.9 | 10.0 | 11.0 | 6.6 | 8.7 | 6.9 |

FEXL1010A series

| Part No. | L0 (μH)±20 % | DCR (mΩ) MAX | Isat (A) | | Irms (A)Typ | | D(mm) ±0.3 |
|----------------|--------------|-----------------|----------|------|-------------|-------------|---------------|
| | | | MAX | Typ | 20℃ rise | 40℃ rise | |
| FEXL1010A-2R2M | 2.20 | 2.8 | 29 | 34 | 24.5 | 32 | 9.3 |
| FEXL1010A-3R3M | 3.30 | 4.1 | 23.4 | 27.4 | 18.2 | 25.0 | 9.3 |
| FEXL1010A-4R7M | 4.70 | 5.7 | 21.4 | 25.4 | 17.5 | 24.0 | 9.3 |
| FEXL1010A-5R6M | 5.60 | 7.2 | 19.6 | 23.6 | 15.7 | 21.2 | 9.3 |
| FEXL1010A-6R8M | 6.80 | 8.9 | 18.5 | 21.8 | 14.0 | 18.5 | 9.0 |
| FEXL1010A-8R2M | 8.20 | 12.4 | 16.3 | 18.3 | 12.9 | 17.1 | 9.0 |
| FEXL1010A-100M | 10.0 | 13.75 | 14.6 | 17.5 | 11.5 | 15.5 | 9.0 |
| FEXL1010A-150M | 15.0 | 19.30 | 12.5 | 15.5 | 9.9 | 13.8 | 9.0 |

FEXL1031A series

| Part No. | L0 (μH)±20 % | DCR (mΩ) MAX | Isat (A) | | Irms (A)Typ | |
|----------------|--------------|-----------------|----------|------|-------------|-------------|
| | | | Max | Typ | 20℃ rise | 40℃ rise |
| FEXL1031A-R28M | 0.28 | 1.60 | 58.0 | 65.0 | 25.5 | 35.0 |
| FEXL1031A-R56M | 0.56 | 2.75 | 39.0 | 44.0 | 23.0 | 32.0 |
| FEXL1031A-R82M | 0.82 | 4.10 | 32.0 | 38.0 | 18.0 | 25.0 |
| FEXL1031A-R90M | 0.90 | 4.20 | 31.0 | 36.0 | 17.0 | 24.0 |
| FEXL1031A-1R0M | 1.00 | 4.95 | 30.0 | 35.0 | 16.0 | 23.0 |
| FEXL1031A-1R5M | 1.50 | 6.60 | 25.0 | 30.0 | 12.0 | 18.0 |

FEXL1060A series

| Part No. | L0 (μH)±20 % | DCR (mΩ) MAX | Isat (A) | | Irms (A)Typ | | D(mm) ±0.3 |
|----------------|--------------|-----------------|----------|------|-------------|-------------|---------------|
| | | | MAX | Typ | 20℃ rise | 40℃ rise | |
| FEXL1060A-R68M | 0.68 | 1.50 | 50.0 | 55.0 | 22.5 | 34.0 | 9.5 |
| FEXL1060A-1R0M | 1.00 | 2.32 | 44.0 | 48.0 | 20.0 | 28.5 | 9.0 |
| FEXL1060A-1R2M | 1.20 | 2.64 | 40.0 | 45.0 | 18.0 | 26.5 | 9.0 |
| FEXL1060A-1R5M | 1.50 | 3.30 | 36.0 | 40.0 | 16.0 | 24.5 | 9.0 |
| FEXL1060A-2R2M | 2.20 | 4.84 | 30.0 | 35.0 | 14.0 | 20.0 | 9.0 |
| FEXL1060A-3R3M | 3.30 | 7.70 | 25.0 | 28.0 | 11.4 | 16.8 | 9.0 |
| FEXL1060A-4R7M | 4.70 | 10.72 | 22.0 | 25.0 | 8.7 | 14.0 | 9.0 |

FEXL1580A series

| Part No. | L0 (μH)±20 % | DCR (mΩ) MAX | Isat (A) | | Irms (A)Typ | |
|----------------|--------------|------------------|----------|------|-------------|-------------|
| | | | Max | Typ | 20℃ rise | 40℃ rise |
| FEXL1580A-2R0M | 2.00 | 2.21 | 52.0 | 57.0 | 29.5 | 40.0 |
| FEXL1580A-2R2M | 2.20 | 2.48 | 49.0 | 55.0 | 28.0 | 37.0 |
| FEXL1580A-3R0M | 3.00 | 3.00 | 41.0 | 46.0 | 26.0 | 34.5 |
| FEXL1580A-4R2M | 4.20 | 4.68 | 33.0 | 38.0 | 20.5 | 27.0 |
| FEXL1580A-5R3M | 5.30 | 5.34 | 31.0 | 35.0 | 19.5 | 26.0 |
| FEXL1580A-6R2M | 6.20 | 6.50 | 31.0 | 34.0 | 17.0 | 23.0 |
| FEXL1580A-7R2M | 7.20 | 7.20 | 29.0 | 32.0 | 15.0 | 21.0 |
| FEXL1580A-8R2M | 8.20 | 7.92 | 25.0 | 28.0 | 13.0 | 19.0 |

FEXL1510A series

| Part No. | L0 (μH)±20 % | DCR (mΩ) MAX | Isat (A) | | Irms (A)Typ | |
|----------------|--------------|------------------|----------|------|-------------|-------------|
| | | | Max | Typ | 20℃ rise | 40℃ rise |
| FEXL1510A-4R7M | 4.7 | 3.8 | 39 | 43 | 22.0 | 30.0 |
| FEXL1510A-5R6M | 5.6 | 4.2 | 34 | 38 | 21.0 | 28.0 |
| FEXL1510A-6R8M | 6.8 | 4.6 | 31.0 | 36.0 | 20.0 | 26.0 |
| FEXL1510A-8R2M | 8.2 | 7.2 | 28.0 | 32.0 | 19.0 | 25.0 |
| FEXL1510A-100M | 10 | 8.6 | 26 | 29 | 18 | 24 |
| FEXL1510A-150M | 15 | 11.5 | 18 | 20 | 14 | 18 |

FEXL1513A series

| Part No. | L0 (μH)±20 % | DCR (mΩ) MAX | Isat (A) | | Irms (A)Typ | |
|----------------|--------------|------------------|----------|------|-------------|-------------|
| | | | Max | Typ | 20℃ rise | 40℃ rise |
| FEXL1513A-4R7M | 4.7 | 3.3 | 40.0 | 44.0 | 23.0 | 31.0 |
| FEXL1513A-5R6M | 5.6 | 3.9 | 35.0 | 40.0 | 22.0 | 29.0 |
| FEXL1513A-6R8M | 6.8 | 4.2 | 32.0 | 37.0 | 21.0 | 27.0 |
| FEXL1513A-8R2M | 8.2 | 5.74 | 29.0 | 33.0 | 20.0 | 26.0 |
| FEXL1513A-100M | 10 | 7.0 | 27.0 | 30.0 | 19.0 | 25.0 |
| FEXL1513A-150M | 15 | 7.5 | 21.0 | 25.5 | 16.0 | 22.0 |
| FEXL1513A-220M | 22 | 13.86 | 19.0 | 22.0 | 12.0 | 17.0 |
| FEXL1513A-330M | 33 | 22.2 | 16.0 | 19.0 | 9.0 | 14.0 |

Notes:

1. Test frequency : L : 100KHz /0. 1V;
2. All test in 25 °C temperature.
3. Testing Instrument:L:HP4285A,CH11025,CH3302,CH1320,CH1320S LCR METER / Rdc:CH16502, MICRO OHMMETER.
4. Heating Rating Current (Irms) will cause the coil temperature rise of 40 °C approximately (Δt):
5. Saturation Current (Isat) will cause L0 to drop 30% approximately.
6. The part temperature (ambient + temp rise) should not exceed 125 °C under the worst case operating condition. Circuit design, component, PCB trace size and thickness airflow and other cooling provisions all could affect the part temperature. Part temperature should be verified in the end application.
7. Special inquiries besides the above common used types can be met on your requirement.
8. For FEXL series inductors,absolute maximum voltage: DC 30V



DCR Test

| Mechanical Reliability | | |
|--------------------------|--|---|
| Item | Specification and Requirement | Test Method |
| Solderability | 1. No case deformation or change in visual 2. New solder coverage More than 95% | 1.Preheat: 155℃±5℃ , 60S±2S 2.Tin: lead-free. 3.Temperature:240℃±5℃ , flux 3.0S±0.5S. |
| Mechanical shock | 1. No case deformation or change in visual 2. $\Delta L/L_0 \leq \pm 10\%$ | 1. Acceleration: 100G 2. Pulse time: 6ms 3. 3 times in each positive and negative direction of 3 mutual perpendicular directions |
| Mechanical vibration | 1. No case deformation or change in visual 2. $\Delta L/L_0 \leq \pm 10\%$ | 1. Reflow: 2times 2. Frequency: 10HZ~50HZ~10HZ , 20 Min/Cycles 3. Amplitude: 1.52 mm±10% 4. Directions: X,Y,Z 5. Time: 12 cycle / direction |
| Endurance Reliability | | |
| Item | Specification and Requirement | Test Method |
| Thermal Shock | Inductance change: Within $\pm 10\%$ Without distinct damage in visual | 1. First -55℃ for 30 minutes , last 125℃ for 30 minutes as 1 cycle. Go through 1000 cycles. 2. Max transfer time is 3 minutes. 3. Measured at room temperature after placing for 24±2 hours |
| Humidity Resistance | Inductance change: Within $\pm 10\%$ Without distinct damage in visual | 1.Reflow 2 times, 2.85℃±3℃,85%±3%RH, 1000 hours 3.Measured at room temperature after placing for 24±2 hours |
| Low temperature storage | Inductance change: Within $\pm 10\%$ Without distinct damage in visual | 1. Temperature: -55 ± 2℃ 2. Time: 1000 hours 3. Measured at room temperature after placing for 24±2 hours |
| High temperature storage | Inductance change: Within $\pm 10\%$ Without distinct damage in visual | 1. Temperature: +125 ± 2℃ 2. Time: 1000 hours 3. Measured at room temperature after placing for 24±2 hours |

Recommended Soldering Technologies

(1) Re-flowing Profile

Preheat condition: 150 ~200°C/60~120sec.

Allowed time above 217°C: 60~90sec.

Peak temp: 260°C

Max time at Peak temp: 10 sec.

Solder paste: Sn/3.0Ag/0.5Cu

Allowed Reflow time: 2x max

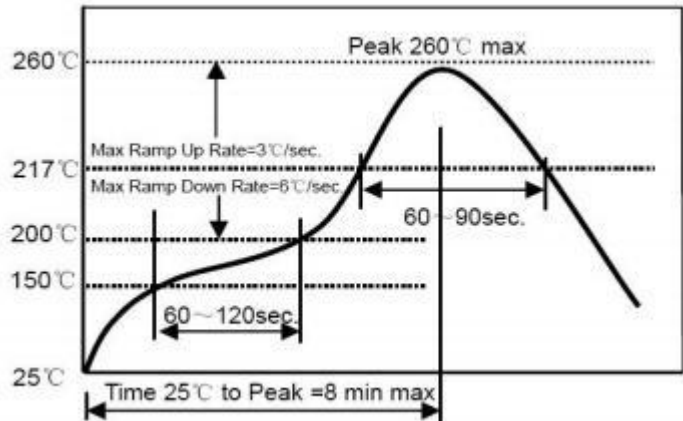

(2) Iron Soldering Profile

Iron soldering power: Max. 30W

Pre-heating: 150°C/60sec.

Soldering Tip temperature: 350°C Max.

Soldering time: 3sec. Max.

Solder paste: Sn/3.0Ag/0.5Cu

Max. 1 times for iron soldering

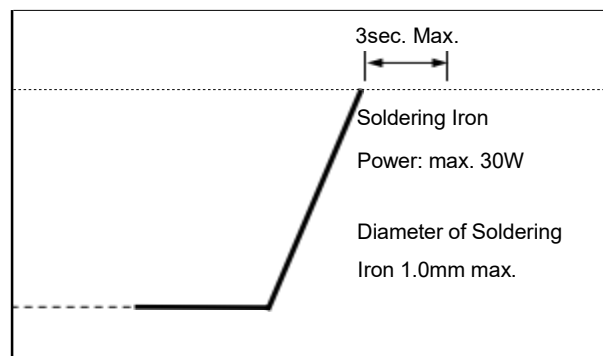

Packaging Information

(1) Tape Packaging Dimensions (Unit: mm)



Taping Drawings (UNIT:mm)



| Type | Tape dimensions (mm) | | | | | | | | | | | |
|-----------|----------------------|------------|-------------|-------------|-------------|-------------|---------------|--------------|--------------|--------------|--------------|--------------|
| | W | P | P0 | P2 | D0 | D1 | T | A0 | B0 | K0 | E | F |
| FEXL0420A | 12 ±0.3 | 8 ±0.1 | 4 ±0.1 | 2 ±0.1 | 1.5 ±0.1 | 1.5 ±0.1 | 0.35 ±0.05 | 4.4 ±0.1 | 4.4 ±0.1 | 2.3 ±0.1 | 1.75 ±0.1 | 5.5 ±0.1 |
| FEXL0430A | 12 ±0.3 | 8 ±0.1 | 4 ±0.1 | 2 ±0.1 | 1.5 ±0.1 | 1.5 ±0.1 | 0.35 ±0.05 | 4.4 ±0.1 | 4.4 ±0.1 | 3.3 ±0.1 | 1.75 ±0.1 | 5.5 ±0.1 |
| FEXL0520A | 12 ±0.3 | 8 ±0.1 | 4 ±0.1 | 2 ±0.1 | 1.5 ±0.1 | 1.5 ±0.1 | 0.35 ±0.05 | 6 ±0.1 | 5.7 ±0.1 | 2.3 ±0.1 | 1.75 ±0.1 | 5.5 ±0.1 |
| FEXL0530A | 16 ±0.3 | 8 ±0.1 | 4 ±0.1 | 2 ±0.1 | 1.5 ±0.1 | 1.5 ±0.1 | 0.35 ±0.05 | 6 ±0.1 | 5.7 ±0.1 | 3.3 ±0.1 | 1.75 ±0.1 | 7.5 ±0.1 |
| FEXL0550A | 16 ±0.3 | 8 ±0.1 | 4 ±0.1 | 2 ±0.1 | 1.5 ±0.1 | 1.5 ±0.1 | 0.35 ±0.05 | 6.0 ±0.1 | 5.7 ±0.1 | 5.3 ±0.1 | 1.75 ±0.1 | 7.5 ±0.1 |
| FEXL0630A | 16 ±0.3 | 12 ±0.1 | 4 ±0.1 | 2 ±0.1 | 1.5 ±0.1 | 1.5 ±0.1 | 0.35 ±0.05 | 7.0 ±0.1 | 6.8 ±0.1 | 3.3 ±0.1 | 1.75 ±0.1 | 7.5 ±0.1 |
| FEXL0650A | 16 ±0.3 | 12 ±0.1 | 4 ±0.1 | 2 ±0.1 | 1.5 ±0.1 | 1.5 ±0.1 | 0.35 ±0.05 | 7.0 ±0.1 | 6.8 ±0.1 | 5.3 ±0.1 | 1.75 ±0.1 | 7.5 ±0.1 |
| FEXL0660A | 16 ±0.3 | 12 ±0.1 | 4 ±0.1 | 2 ±0.1 | 1.5 ±0.1 | 1.5 ±0.1 | 0.35 ±0.05 | 7.0 ±0.1 | 6.8 ±0.1 | 6.3 ±0.1 | 1.75 ±0.1 | 7.5 ±0.1 |
| FEXL0720A | 16 ±0.3 | 12 ±0.1 | 4 ±0.1 | 2 ±0.1 | 1.5 ±0.1 | 1.5 ±0.1 | 0.35 ±0.05 | 8.2 ±0.1 | 8.0 ±0.1 | 2.3 ±0.1 | 1.75 ±0.1 | 7.5 ±0.1 |
| FEXL0730A | 16 ±0.3 | 12 ±0.1 | 4 ±0.1 | 2 ±0.1 | 1.5 ±0.1 | 1.5 ±0.1 | 0.35 ±0.05 | 8.2 ±0.1 | 8.0 ±0.1 | 3.3 ±0.1 | 1.75 ±0.1 | 7.5 ±0.1 |
| FEXL0770A | 16 ±0.3 | 12 ±0.1 | 4 ±0.1 | 2 ±0.1 | 1.5 ±0.1 | 1.5 ±0.1 | 0.35 ±0.05 | 8.2 ±0.1 | 8.0 ±0.1 | 7.3 ±0.1 | 1.75 ±0.1 | 7.5 ±0.1 |
| FEXL0880A | 24 ±0.3 | 16 ±0.1 | 4 ±0.1 | 2 ±0.05 | 1.5 ±0.1 | 1.5 ±0.1 | 0.35 ±0.05 | 9.4 ±0.1 | 8.9 ±0.1 | 8.5 ±0.1 | 1.75 ±0.1 | 11.5 ±0.1 |
| FEXL1010A | 24 ±0.3 | 16 ±0.1 | 4 ±0.1 | 2 ±0.05 | 1.5 ±0.1 | 1.5 ±0.1 | 0.35 ±0.05 | 12.4 ±0.1 | 11.5 ±0.1 | 10.3 ±0.1 | 1.75 ±0.1 | 11.5 ±0.1 |
| FEXL1031A | 24 ±0.3 | 16 ±0.1 | 4 ±0.1 | 2 ±0.05 | 1.5 ±0.1 | 1.5 ±0.1 | 0.35 ±0.05 | 12.4 ±0.1 | 11.5 ±0.1 | 3.3 ±0.1 | 1.75 ±0.1 | 11.5 ±0.1 |
| FEXL1060A | 24 ±0.3 | 16 ±0.1 | 4 ±0.1 | 2 ±0.05 | 1.5 ±0.1 | 1.5 ±0.1 | 0.35 ±0.05 | 12.4 ±0.1 | 11.5 ±0.1 | 6.3 ±0.1 | 1.75 ±0.1 | 11.5 ±0.1 |
| FEXL1510A | 32 ±0.3 | 24 ±0.1 | 4.0 ±0.1 | 2.0 ±0.1 | 1.5 ±0.1 | 1.5 ±0.1 | 0.5 ±0.05 | 17 ±0.1 | 16 ±0.1 | 10.5 ±0.1 | 1.75 ±0.1 | 14.2 ±0.1 |
| FEXL1513A | 32 ±0.3 | 24 ±0.1 | 4.0 ±0.1 | 2.0 ±0.1 | 1.5 ±0.1 | 1.5 ±0.1 | 0.5 ±0.05 | 17 ±0.1 | 16 ±0.1 | 13.6 ±0.1 | 1.75 ±0.1 | 14.2 ±0.1 |
| FEXL1580A | 32 ±0.3 | 24 ±0.1 | 4.0 ±0.1 | 2.0 ±0.1 | 1.5 ±0.1 | 1.5 ±0.1 | 0.5 ±0.05 | 17 ±0.1 | 16 ±0.1 | 8.5 ±0.1 | 1.75 ±0.1 | 14.2 ±0.1 |

(2) Reel Dimensions (Unit: mm)

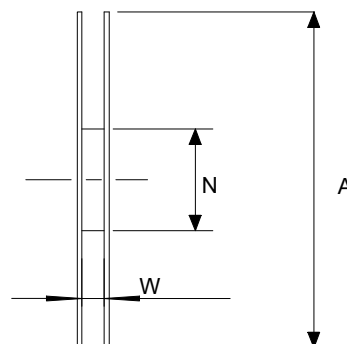
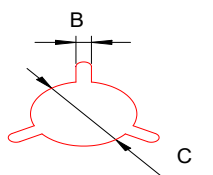
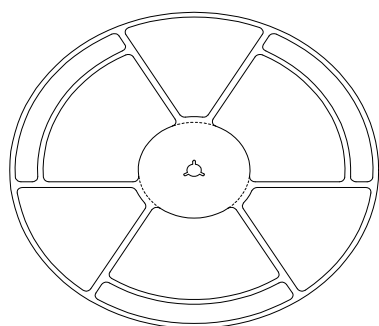

| Type | A | W | N | B | C |
|-----------|---------|----------|--------|---------|----------|
| FEXL0420A | 330+2.0 | 12.8±0.2 | 97±0.5 | 2.2+0.5 | 13.0±0.2 |
| FEXL0430A | 330+2.0 | 12.8±0.2 | 97±0.5 | 2.2+0.5 | 13.0±0.2 |
| FEXL0520A | 330+2.0 | 12.8+0.2 | 97+0.5 | 2.2+0.5 | 13.2±0.2 |
| FEXL0530A | 330+2.0 | 16.8+0.2 | 97+0.5 | 2.2+0.5 | 13.2±0.2 |
| FEXL0550A | 330+2.0 | 16.8+0.2 | 97+0.5 | 2.2+0.5 | 13.2±0.2 |
| FEXL0630A | 330+2.0 | 16.8+0.2 | 97+0.5 | 2.2+0.5 | 13.2±0.2 |
| FEXL0650A | 330+2.0 | 16.8+0.2 | 97+0.5 | 2.2+0.5 | 13.2±0.2 |
| FEXL0660A | 330+2.0 | 16.8+0.2 | 97+0.5 | 2.2+0.5 | 13.2±0.2 |
| FEXL0720A | 330+2.0 | 16.8+0.2 | 97+0.5 | 2.2+0.5 | 13.2±0.2 |
| FEXL0730A | 330+2.0 | 16.8+0.2 | 97+0.5 | 2.2+0.5 | 13.2±0.2 |
| FEXL0770A | 330+2.0 | 16.8±0.5 | 97±0.5 | 2.2+0.5 | 132±0.2 |
| FEXL0880A | 330+2.0 | 24±0.5 | 97±0.5 | 2.2+0.5 | 13.0±0.2 |

| | | | | | |
|-----------|---------|--------|--------|---------|----------|
| FEXL1010A | 330+2.0 | 24±0.5 | 97±0.5 | 2.2+0.5 | 13.0±0.2 |
| FEXL1031A | 330+2.0 | 24±0.5 | 97±0.5 | 2.2+0.5 | 13.0±0.2 |
| FEXL1060A | 330+2.0 | 24±0.5 | 97±0.5 | 2.2+0.5 | 13.0±0.2 |
| FEXL1510A | 330+2.0 | 32±0.5 | 97±0.5 | 2.2+0.5 | 13.0±0.2 |
| FEXL1513A | 330+2.0 | 32±0.5 | 97±0.5 | 2.2+0.5 | 13.0±0.2 |
| FEXL1580A | 330+2.0 | 32±0.5 | 97±0.5 | 2.2+0.5 | 13.0±0.2 |

(3)Packaging Quantity

| Type | Standard Quantity | | |
|-----------|-------------------|-------------------------|----------------------------------|
| | Reel | Inner box | Carton box |
| FEXL0420A | 3000 pcs / reel | 4Reel / box (12000 pcs) | 3Middle boxes, (36,000 pcs) |
| FEXL0430A | 3000 pcs / reel | 4Reel / box (12000 pcs) | 3Middle boxes, (36,000 pcs) |
| FEXL0520A | 3000 pcs / reel | 3Reel / box (9000 pcs) | 3 Middle boxes, (27,000 pcs) |
| FEXL0530A | 2000 pcs / reel | 3Reel / box (6000 pcs) | 3 Middle boxes, (18,000 pcs) |
| FEXL0550A | 1500 pcs / reel | 3Reel / box (4500 pcs) | 3 Middle boxes, (13,500 pcs) |
| FEXL0630A | 1000 pcs / reel | 3Reel / box (3000 pcs) | 3 Middle boxes, (9,000 pcs) |
| FEXL0650A | 1000 pcs / reel | 3Reel / box (3000 pcs) | 3 Middle boxes, (9,000 pcs) |
| FEXL0660A | 750 pcs / reel | 3Reel / box (2250 pcs) | 3 Middle boxes, (6,750 pcs) |
| FEXL0720A | 2000pcs / reel | 3Reel / box (6000 pcs) | 3 Middle boxes, (18000 pcs) |
| FEXL0730A | 1500 pcs / reel | 3Reel / box (4500 pcs) | 3 Middle boxes, (13,500 pcs) |

| | | | |
|-----------|----------------|------------------------|--------------------------------|
| FEXL0770A | 750 pcs / reel | 3Reel / box (2250 pcs) | 3 Middle boxes, (6,750 pcs) |
| FEXL0880A | 450pcs / reel | 2Reel / box (900 pcs) | 3 Middle boxes, (2700 pcs) |
| FEXL1010A | 300 pcs / reel | 2Reel / box (600 pcs) | 3 Middle boxes, (1800 pcs) |
| FEXL1031A | 300 pcs / reel | 2Reel / box (600 pcs) | 3 Middle boxes, (1800 pcs) |
| FEXL1060A | 500 pcs / reel | 2Reel / box (1000 pcs) | 3 Middle boxes, (3000 pcs) |
| FEXL1510A | 150 pcs / reel | 2Reel / box (300 pcs) | 3 Middle boxes, (900 pcs) |
| FEXL1513A | 100 pcs / reel | 2Reel / box (200 pcs) | 3 Middle boxes, (600 pcs) |
| FEXL1580A | 200 pcs / reel | 2Reel / box (400 pcs) | 3 Middle boxes, (1200 pcs) |

(4) Peel force of top cover tape

The peel speed shall be about 300mm/minute

The peel force of top cover tape shall be between 0. 1 to 1.3 N



(5) Reel Label

Label on the reel

- Customer's part Number
- Lot Number
- Quantity
- date code

Shipping Label

- Customer's part Number
- Manufacturer's part Number
- Quantity
- date code



(6) Inner Box



| Packaging type | A (mm) | B (mm) | B (mm) |
|----------------|--------|--------|--------|
| inner box | 354 | 335 | 86 |

(7) Carton



| Packaging type | A (mm) | B (mm) | B (mm) |
|----------------|--------|--------|--------|
| type | 370 | 365 | 285 |

Appearance criterion

1 、 PAD residual powder 、 inner wire exposed 、 imprinting

The residual powder on both side of pad is norm and within following criteria are acceptable.

The imprinting mark below the part, are norm in manufacturing process and does not affect the function and it is acceptable.

Front lit imprinting is acceptable.

| | |
|---|-----------------------------------|
| a | 10% max of the length of pad. |
| b | 5% of the area on one single pad. |
| t | 0.08mm max. |

Foreign materials on the product body is inevitable and accepted.

2 、 Defects

Chip off is generated during molding and manufacturing process .

Chip off acceptance limits subjected to the product size .

Our current Defect limit is based on the IPC- A- 6 1 0 .

Some chip off does not impact the product function, see the IPC standard 1 & 2 .

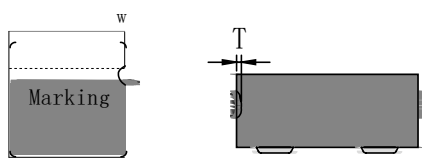

| | | |
|---|------------------------|--|
| T | ≤ 10% of the thickness | Each surface can only accept one minor chip off , and more than 3 chip off problems are not allowed on the same product. |
| W | ≤ 10 % of the width | |
| L | ≤ 10 % of the length | |

Defects usually occur at the corners and edges of the product, There will be a slight defect black and rough, but not exposed copper, and does not affect the product performance and reliability.

3 、 Crack

Production process of cracks appearing in the body is inevitable, some slight crack is caused because the molding, is not oxidized, crack on the product will not affect product performance.

We have done a reliability test of crack products , even if cracks is more than 0 . 1 3 mm also will not affect the electrical properties of the product, crack limits as follows:

Severely crack: not acceptable. More obvious cracks extended from side to side.

Moderate crack: not acceptable. Very obvious and may result in powder come off and exposed of copper wire.

Slight crack: acceptable.

Slight wire expose: acceptable. wire exposed during Press process.

Lead wire imprint: acceptable. Turns of wires that close to the edge and imprint show.

Products from a slight crack in the baking process due to thermal expansion, and it is not obvious by visual inspection (Must not exceed the blue square area).

Cracks on the same side surface are not allowed to exceed 1/2 of the length of the side and the crack width cannot exceed 0. 13mm, and only 1 crack is allowed on the same side.

Bottom cracks are not allowed to exceed 1/2 of the length (or width) of the corresponding body nor the Non-manufacturability swelling, and the crack width cannot be exceed 0. 13mm, and less than 2 cracks are allowed and judged as good products.

Visible cracks and non-manufacturability bulging are not allowed on the front side.

4 、 oxidation(rust)

the contains iron composite, although the resin has a protective effect of oxidation, but there will be small amount of product that may occur oxidation, The oxidation area of each surface is allowed to be about 25% (in the case of non-reliability test), it is recommend that customer use this product in humidity controlled environment. The basic steps should be to protect the surface oxidation, including the sealed packages to PCB mount inductors. To avoid the adverse effects caused by oxidation, Oxidation occurs at the surface only allows the internal oxidation is not allowed, oxidized surface will not affect the reliability of the product.



can be accepted if recognizable

Visual inspection: Examination with the naked eye, to distinguish from more technical modes of analysis employing tools or apparatus.

X-ON Electronics

Largest Supplier of Electrical and Electronic Components

Click to view similar products for [Fixed Inductors](#) category:

Click to view products by [Changjiang Microelectronics](#) manufacturer:

Other Similar products are found below :

[CR32NP-100KC](#) [70F224AI](#) [MHQ1005P10NJ](#) [MHQ1005P1N0S](#) [MHQ1005P2N4S](#) [MHQ1005P3N6S](#) [MHQ1005P5N1S](#) [MHQ1005P8N2J](#)
[PE-53601NL](#) [PE-53602NL](#) [PG0936.113NLT](#) [9220-20](#) [9310-16](#) [PM06-2N7](#) [PM06-39NJ](#) [A01TK](#) [1206CS-471XJ](#) [HC2-R47-R](#) [HC8-1R2-R](#)
[HCF1305-3R3-R](#) [1206CS-151XG](#) [RCH664NP-4R7M](#) [RCP1317NP-391L](#) [DH2280-4R7M](#) [DS1608C-106](#) [B10TJ](#) [B82498B3101J000](#) [ELJ-](#)
[RE27NJF2](#) [1812CS-153XJ](#) [1812CS-183XJ](#) [1812CS-223XJ](#) [1812LS-104XJ](#) [1812LS-105XJ](#) [1812LS-124XJ](#) [1812LS-154XJ](#) [1812LS-223XJ](#)
[1812LS-224XJ](#) [1812LS-563XJ](#) [1812LS-683XJ](#) [1812LS-824XJ](#) [NIN-FB101JTR110F](#) [NIN-FB471JTR62F](#) [NIN-FC1R5JTR220F](#) [NIN-](#)
[HCR15JTRF](#) [NIN-HCR33JTRF](#) [NIN-HDR22JTRF](#) [NIN-HDR82JTRF](#) [NIN-HK2N7STRF](#) [NIN-PA150KTR370F](#) [NIN-PB100KTR550F](#)