

Wire Wound SMD Power Inductors – FNR Series

Operating temperature range:
-40 °C~+125 °C (Including self-heating)



FEATURES

- Magnetic-resin shielded construction reduces buzz noise to ultra-low levels
- Metallization on ferrite core results in excellent shock resistance and damage-free durability
- Closed magnetic circuit design reduces leakage flux and Electro Magnetic Interference (EMI)
- 30% higher current rating than conventional inductors of equal size
- Takes up less PCB real estate and save more power

特征

- 磁性膠水塗敷結構極大減少了蜂鳴聲
- 在磁芯上金屬化電極，抗跌落沖擊強，經久耐用
- 閉合磁路結構設計，漏磁少，抗 EMI 能力強
- 電流特性較同等尺寸傳統電感高出30%以上
- 省空間，更省電

APPLICATIONS

- Smart phone, smart TV, set top box, notebook
- Car navigation systems, telecomm base stations
- VR, AR
- LED lighting
- SSD, Bluetooth, Wi-Fi module
- NB-IOT, Bluetooth headset, Smartspeakers

用途

- 智能手機，智能電視，機頂盒，筆記本電腦
- 汽車導航系統，通信設備
- 虛擬現實，增強現實
- LED 照明
- 固態硬盤、藍牙、WIFI 模塊
- 物聯網模塊、藍牙耳機、智能音箱

PRODUCT IDENTIFICATION

① FNR		② 3015		③ S		④ 1R0		⑤ M		⑥ T		⑦ □□□	
Type		External Dimensions (L×W×H) [mm]											
FNR	Wire Wound SMD Power Inductor	252010	2.5×2.0×1.0	252012	2.5×2.0×1.2	3010	3.0×3.0×1.0	3012	3.0×3.0×1.2	3015	3.0×3.0×1.5	3021	3.0×3.0×2.1
③ Feature Type		4010	4.0×4.0×1.0	Standard		4012	4.0×4.0×1.2	4015	4.0×4.0×1.5	4018	4.0×4.0×1.8	4020	4.0×4.0×2.0
④ Nominal Inductance		4026	4.0×4.0×2.6	Example		Nominal Value		4030	4.0×4.0×3.0	5012	5.0×5.0×1.2	5015	5.0×5.0×1.5
⑤ Inductance Tolerance		5020	5.0×5.0×2.0	K	±10%	5030	5.0×5.0×3.0	5040	5.0×5.0×4.0	5045	5.0×5.0×4.5	6020	6.0×6.0×2.0
⑥ Packing		6028	6.0×6.0×2.8	M	±20%	6040	6.0×6.0×4.0	6045	6.0×6.0×4.5	6028	6.0×6.0×2.8	6040	6.0×6.0×4.0
⑦ Design Code		8040	8.0×8.0×4.0	N	±30%	8050	8.0×8.0×5.0	8065	8.0×8.0×6.5	8040	8.0×8.0×4.0	8050	8.0×8.0×5.0
□□□		Standard product is blank											

Specifications subject to change without notice. Please check our website for latest informations.

SHAPE AND DIMENSIONS

Fig.1

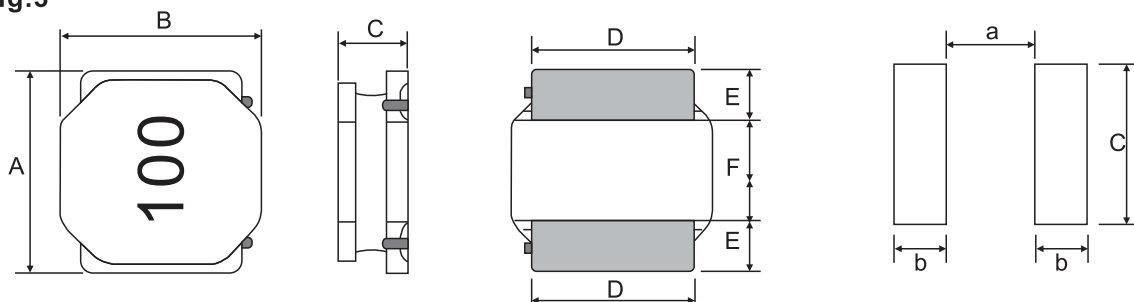

Fig.2



Recommended Land Pattern

Fig.3



Unit: mm

Series	Shape	A	B	C	D	E	F	A Typ.	B Typ.	C Typ.
FNR252010S	Fig.1	2.5±0.1	2.0±0.1	1.0Max.	2.0±0.2	0.80±0.2	0.80±0.2	0.80	0.85	2.0
FNR252012S	Fig.1	2.5±0.1	2.0±0.1	1.2Max.	2.0±0.2	0.80±0.2	0.80±0.2	0.80	0.85	2.0
FNR3010S	Fig.2	3.0±0.2	3.0±0.2	1.0Max.	2.5±0.2	0.75±0.2	1.5±0.2	1.5	0.8	2.7
FNR3012S	Fig.2	3.0±0.2	3.0±0.2	1.2Max.	2.5±0.2	0.75±0.2	1.5±0.2	1.5	0.8	2.7
FNR3015S	Fig.2	3.0±0.2	3.0±0.2	1.5Max.	2.5±0.2	0.75±0.2	1.5±0.2	1.5	0.8	2.7
FNR3021S	Fig.2	3.0±0.2	3.0±0.2	2.35Max.	2.5±0.2	0.75±0.2	1.5±0.2	1.5	0.8	2.7
FNR4010S	Fig.2	4.0±0.2	4.0±0.2	1.0Max.	3.3±0.2	0.95±0.2	2.1±0.2	1.9	1.1	3.7
FNR4012S	Fig.2	4.0±0.2	4.0±0.2	1.2Max.	3.3±0.2	0.95±0.2	2.1±0.2	1.9	1.1	3.7
FNR4015S	Fig.2	4.0±0.2	4.0±0.2	1.65Max.	3.3±0.2	0.95±0.2	2.1±0.2	1.9	1.1	3.7
FNR4018S	Fig.2	4.0±0.2	4.0±0.2	1.8Max.	3.3±0.2	0.95±0.2	2.1±0.2	1.9	1.1	3.7
FNR4020S	Fig.2	4.0±0.2	4.0±0.2	2.0Max.	3.3±0.2	0.95±0.2	2.1±0.2	1.9	1.1	3.7
FNR4026S	Fig.2	4.0±0.2	4.0±0.2	2.6Max.	3.3±0.2	0.95±0.2	2.1±0.2	1.9	1.1	3.7
FNR4030S	Fig.2	4.0±0.2	4.0±0.2	3.0Max.	3.3±0.2	0.95±0.2	2.1±0.2	1.9	1.1	3.7
FNR5012S	Fig.3	5.0±0.2	5.0±0.2	1.2Max.	4.0±0.2	1.25±0.2	2.5±0.2	2.3	1.4	4.2
FNR5015S	Fig.3	5.0±0.2	5.0±0.2	1.5Max.	4.0±0.2	1.25±0.2	2.5±0.2	2.3	1.4	4.2
FNR5020S	Fig.3	5.0±0.2	5.0±0.2	2.0Max.	4.0±0.2	1.25±0.2	2.5±0.2	2.3	1.4	4.2
FNR5030S	Fig.3	5.0±0.2	5.0±0.2	3.0Max.	4.0±0.2	1.25±0.2	2.5±0.2	2.3	1.4	4.2
FNR5040S	Fig.3	5.0±0.2	5.0±0.2	4.0Max.	4.0±0.2	1.25±0.2	2.5±0.2	2.3	1.4	4.2
FNR5045S	Fig.3	5.0±0.2	5.0±0.2	4.5Max.	4.0±0.2	1.25±0.2	2.5±0.2	2.3	1.4	4.2
FNR6020S	Fig.2	6.0±0.3	6.0±0.3	2.0Max.	4.9±0.3	1.55±0.3	2.9±0.3	2.8	1.7	5.7
FNR6028S	Fig.2	6.0±0.3	6.0±0.3	2.8Max.	4.9±0.3	1.55±0.3	2.9±0.3	2.8	1.7	5.7
FNR6040S	Fig.2	6.0±0.3	6.0±0.3	4.0Max.	4.9±0.3	1.55±0.3	2.9±0.3	2.8	1.7	5.7
FNR6045S	Fig.2	6.0±0.3	6.0±0.3	4.5Max.	4.9±0.3	1.55±0.3	2.9±0.3	2.8	1.7	5.7
FNR8040S	Fig.2	8.0±0.3	8.0±0.3	4.2Max.	6.3±0.3	2.00±0.3	4.0±0.3	3.8	2.2	7.5
FNR8050S	Fig.3	8.0±0.3	8.0±0.3	5.0Max.	6.3±0.3	2.00±0.3	4.0±0.3	3.8	2.2	7.5
FNR8065S	Fig.3	8.0±0.3	8.0±0.3	6.5Max.	6.3±0.3	2.00±0.3	4.0±0.3	3.8	2.2	7.5

※*1: All products are printed with Marking except the 252010S, 252012S, 3010S, 3012S, 3015S and 3021S series.

SPECIFICATIONS

FNR252010S Series

Part Number	Inductance	DC Resistance		Self-resonant Frequency	Saturation Current*3		Heat Rating Current*4	
	@100kHz,1V	Max.	Typ.	Min.	Max.	Typ.	Max.	Typ.
Units	μH	Ω		MHz	A		A	
Symbol	L	DCR		S.R.F	Isat		Irms	
FNR252010SR47NT	0.47±30%	0.056	0.047	206	2.50	3.35	2.35	2.56
FNR252010SR56NT	0.56±30%	0.072	0.060	160	2.90	3.20	2.00	2.18
FNR252010SR68NT	0.68±30%	0.074	0.062	129	2.20	2.75	2.00	2.18
FNR252010S1R0NT	1.0±30%	0.108	0.090	100	1.85	2.20	1.65	1.80
FNR252010S1R5NT	1.5±30%	0.182	0.152	81	1.80	2.10	1.30	1.42
FNR252010S2R2NT	2.2±30%	0.209	0.174	61	1.20	1.60	1.20	1.31
FNR252010S3R3MT	3.3±20%	0.328	0.273	47	1.05	1.30	0.90	0.98
FNR252010S4R7MT	4.7±20%	0.563	0.469	42	0.95	1.15	0.70	0.76
FNR252010S5R6MT	5.6±20%	0.563	0.469	35	0.80	0.95	0.73	0.80
FNR252010S6R8MT	6.8±20%	0.896	0.747	31	0.78	0.92	0.59	0.64
FNR252010S100MT	10±20%	1.092	0.910	27	0.65	0.78	0.50	0.55

FNR252012S Series

Part Number	Inductance	DC Resistance		Self-resonant Frequency	Saturation Current*3		Heat Rating Current*4	
	@100kHz,1V	Max.	Typ.	Min.	Max.	Typ.	Max.	Typ.
Units	μH	Ω		MHz	A		A	
Symbol	L	DCR		S.R.F	Isat		Irms	
FNR252012SR47NT	0.47±30%	0.061	0.047	160	3.82	4.27	2.15	2.34
FNR252012SR68NT	0.68±30%	0.074	0.057	140	3.28	3.68	1.95	2.13
FNR252012S1R0NT	1.0±30%	0.090	0.069	110	2.59	2.90	1.93	2.10
FNR252012S1R2NT	1.2±30%	0.129	0.099	100	2.38	2.67	1.46	1.59
FNR252012S1R5MT	1.5±20%	0.147	0.113	97	2.24	2.51	1.40	1.53
FNR252012S2R2MT	2.2±20%	0.216	0.166	69	1.85	2.07	1.15	1.25
FNR252012S2R7MT	2.7±20%	0.239	0.184	63	1.72	1.92	1.09	1.19
FNR252012S3R3MT	3.3±20%	0.264	0.203	62	1.61	1.80	1.04	1.13
FNR252012S3R6MT	3.6±20%	0.348	0.268	53	1.46	1.64	0.90	0.98
FNR252012S4R3MT	4.3±20%	0.377	0.290	51	1.37	1.53	0.87	0.95
FNR252012S4R7MT	4.7±20%	0.377	0.290	47	1.12	1.25	0.84	0.92
FNR252012S5R1MT	5.1±20%	0.500	0.385	44	1.23	1.37	0.75	0.82
FNR252012S5R6MT	5.6±20%	0.538	0.414	38	1.11	1.25	0.73	0.80
FNR252012S6R2MT	6.2±20%	0.542	0.417	38	1.03	1.16	0.73	0.80
FNR252012S6R8MT	6.8±20%	0.581	0.447	38	0.98	1.09	0.69	0.75
FNR252012S7R5MT	7.5±20%	0.611	0.470	35	0.97	1.09	0.68	0.74
FNR252012S8R2MT	8.2±20%	0.658	0.506	36	0.98	1.10	0.65	0.71
FNR252012S9R1MT	9.1±20%	0.690	0.531	34	0.91	1.02	0.62	0.68
FNR252012S100MT	10±20%	0.690	0.531	34	0.79	0.88	0.62	0.68
FNR252012S120MT	12±20%	1.075	0.827	28	0.78	0.88	0.51	0.56
FNR252012S150MT	15±20%	1.591	1.224	25	0.68	0.77	0.42	0.46
FNR252012S220MT	22±20%	1.976	1.520	20	0.53	0.59	0.38	0.41

SPECIFICATIONS

FNR3010S Series

Part Number	Inductance	DC Resistance		Self-resonant Frequency	Saturation Current*3		Heat Rating Current*4	
	@100kHz,1V	Max.	Typ.	Min.	Max.	Typ.	Max.	Typ.
Units	μH	Ω		MHz	A		A	
Symbol	L	DCR		S.R.F	Isat		Irms	
FNR3010S1R0NT	1.0±30%	0.085	0.065	180	1.40	2.10	1.45	1.80
FNR3010S1R2NT	1.2±30%	0.085	0.065	137	1.25	1.70	1.45	1.80
FNR3010S1R5NT	1.5±30%	0.104	0.080	120	1.27	1.70	1.30	1.60
FNR3010S2R2NT	2.2±30%	0.143	0.110	100	1.15	1.50	1.09	1.40
FNR3010S2R7NT	2.7±30%	0.169	0.130	90	1.00	1.20	1.02	1.40
FNR3010S3R3NT	3.3±30%	0.189	0.145	74	0.97	1.20	0.96	1.20
FNR3010S3R6MT	3.6±20%	0.215	0.165	67	0.95	1.20	0.90	1.10
FNR3010S4R7MT	4.7±20%	0.293	0.225	59	0.75	1.05	0.77	1.10
FNR3010S5R6MT	5.6±20%	0.322	0.248	40	0.58	0.65	0.70	1.05
FNR3010S6R8MT	6.8±20%	0.397	0.305	42	0.55	0.72	0.66	0.96
FNR3010S8R2MT	8.2±20%	0.520	0.400	23	0.55	0.70	0.58	0.70
FNR3010S100MT	10±20%	0.520	0.400	39	0.55	0.75	0.58	0.70
FNR3010S120MT	12±20%	0.657	0.505	36	0.43	0.65	0.52	0.67
FNR3010S150MT	15±20%	0.793	0.610	30	0.42	0.57	0.47	0.57
FNR3010S220MT	22±20%	1.209	0.930	28	0.35	0.48	0.38	0.52
FNR3010S270MT	27±20%	1.404	1.080	25	0.30	0.45	0.35	0.50
FNR3010S330MT	33±20%	2.015	1.550	18	0.29	0.42	0.30	0.55
FNR3010S390MT	39±20%	2.275	1.750	18	0.28	0.38	0.28	0.53
FNR3010S430MT	43±20%	2.340	1.800	18	0.23	0.36	0.27	0.52
FNR3010S470MT	47±20%	2.535	1.950	18	0.22	0.35	0.26	0.52
FNR3010S510MT	51±20%	2.860	2.200	18	0.21	0.33	0.25	0.48
FNR3010S560MT	56±20%	3.016	2.320	16	0.21	0.28	0.24	0.35

FNR3012S Series

Part Number	Inductance	DC Resistance		Self-resonant Frequency	Saturation Current*3		Heat Rating Current*4	
	@100kHz,1V	Max.	Typ.	Min.	Max.	Typ.	Max.	Typ.
Units	μH	Ω		MHz	A		A	
Symbol	L	DCR		S.R.F	Isat		Irms	
FNR3012SR22NT	0.22±30%	0.022	0.017	321	5.30	6.00	3.00	3.30
FNR3012SR82NT	0.82±30%	0.039	0.030	180	2.05	2.80	2.47	3.00
FNR3012S1R0NT	1.0±30%	0.052	0.040	120	1.87	2.80	2.20	2.70
FNR3012S1R2NT	1.2±30%	0.059	0.045	120	2.22	2.50	2.01	2.20
FNR3012S1R5NT	1.5±30%	0.059	0.045	110	1.62	1.90	2.01	2.20
FNR3012S1R8NT	1.8±30%	0.082	0.063	90	1.30	1.90	1.65	1.80
FNR3012S2R2NT	2.2±30%	0.098	0.075	84	1.20	1.90	1.55	1.70
FNR3012S2R4NT	2.4±30%	0.088	0.068	100	1.15	1.50	1.60	1.70
FNR3012S2R7NT	2.7±30%	0.110	0.085	65	1.14	1.50	1.48	1.50
FNR3012S3R3MT	3.3±20%	0.130	0.100	64	1.05	1.50	1.36	1.40
FNR3012S3R6MT	3.6±20%	0.130	0.100	36	1.05	1.50	1.36	1.40
FNR3012S3R9MT	3.9±20%	0.189	0.145	61	1.00	1.30	1.24	1.30
FNR3012S4R7MT	4.7±20%	0.156	0.120	61	0.90	1.00	1.24	1.30
FNR3012S5R6MT	5.6±20%	0.226	0.174	61	0.80	1.10	1.13	1.24
FNR3012S6R8MT	6.8±20%	0.247	0.190	61	0.75	0.90	0.98	1.10
FNR3012S100MT	10±20%	0.345	0.265	42	0.60	0.88	0.83	0.90
FNR3012S120MT	12±20%	0.449	0.345	32	0.48	0.67	0.73	0.84
FNR3012S150MT	15±20%	0.468	0.360	27	0.45	0.62	0.71	0.77
FNR3012S180MT	18±20%	0.709	0.545	25	0.43	0.59	0.58	0.65

SPECIFICATIONS

FNR3012S Series

Part Number	Inductance	DC Resistance		Self-resonant Frequency	Saturation Current*3		Heat Rating Current*4	
	@100kHz, 1V	Max.	Typ.	Min.	Max.	Typ.	Max.	Typ.
Units	μH	Ω		MHz	A		A	
Symbol	L	DCR		S.R.F	Isat		Irms	
FNR3012S220MT	22±20%	0.839	0.645	23	0.42	0.52	0.53	0.59
FNR3012S270MT	27±20%	1.131	0.870	21	0.35	0.48	0.47	0.51
FNR3012S330MT	33±20%	1.138	0.875	18	0.36	0.46	0.46	0.50
FNR3012S360MT	36±20%	1.235	0.950	18	0.34	0.44	0.44	0.48
FNR3012S390MT	39±20%	1.729	1.330	18	0.30	0.39	0.37	0.41
FNR3012S470MT	47±20%	1.885	1.450	14	0.27	0.35	0.35	0.40
FNR3012S560MT	56±20%	1.794	1.380	9	0.26	0.33	0.28	0.40
FNR3012S680MT	68±20%	2.171	1.670	7	0.24	0.29	0.33	0.37
FNR3012S820MT	82±20%	3.302	2.540	7	0.17	0.27	0.27	0.31
FNR3012S101MT	100±20%	3.718	2.860	5	0.21	0.23	0.25	0.29

FNR3015S Series

Part Number	Inductance	DC Resistance		Self-resonant Frequency	Saturation Current*3		Heat Rating Current*4	
	@100kHz, 1V	Max.	Typ.	Min.	Max.	Typ.	Max.	Typ.
Units	μH	Ω		MHz	A		A	
Symbol	L	DCR		S.R.F	Isat		Irms	
FNR3015SR50NT	0.5±30%	0.039	0.030	162	3.90	4.20	2.60	2.80
FNR3015S1R0NT	1.0±30%	0.039	0.030	150	2.32	2.80	2.35	2.50
FNR3015S1R2NT	1.2±30%	0.052	0.040	110	2.21	3.10	1.95	2.30
FNR3015S1R5NT	1.5±30%	0.065	0.050	100	2.30	2.70	1.70	2.20
FNR3015S1R8NT	1.8±30%	0.065	0.050	92	1.75	2.20	1.70	2.20
FNR3015S2R2NT	2.2±30%	0.078	0.060	86	1.60	2.00	1.60	2.00
FNR3015S2R7NT	2.7±30%	0.098	0.075	64	1.52	1.90	1.43	1.90
FNR3015S3R3MT	3.3±20%	0.104	0.080	68	1.32	1.81	1.36	1.60
FNR3015S3R6MT	3.6±20%	0.137	0.105	59	1.28	1.60	1.20	1.50
FNR3015S3R9MT	3.9±20%	0.137	0.105	47	1.20	1.40	1.20	1.50
FNR3015S4R3MT	4.3±20%	0.150	0.115	53	1.20	1.40	1.14	1.30
FNR3015S4R7MT	4.7±20%	0.163	0.125	46	1.10	1.40	1.09	1.30
FNR3015S5R1MT	5.1±20%	0.173	0.133	49	1.00	1.20	1.05	1.20
FNR3015S6R2MT	6.2±20%	0.254	0.195	46	1.00	1.20	0.86	1.00
FNR3015S6R8MT	6.8±20%	0.260	0.200	39	0.85	1.10	0.85	1.10
FNR3015S100MT	10±20%	0.325	0.250	41	0.72	0.92	0.77	0.90
FNR3015S120MT	12±20%	0.416	0.320	32	0.70	0.90	0.68	0.89
FNR3015S150MT	15±20%	0.455	0.350	30	0.66	0.88	0.65	0.72
FNR3015S180MT	18±20%	0.559	0.430	23	0.56	0.72	0.59	0.72
FNR3015S220MT	22±20%	0.598	0.460	23	0.52	0.68	0.57	0.69
FNR3015S270MT	27±20%	0.949	0.730	22	0.48	0.56	0.45	0.56
FNR3015S330MT	33±20%	1.066	0.820	20	0.44	0.53	0.43	0.51
FNR3015S390MT	39±20%	1.294	0.995	14	0.41	0.55	0.39	0.44
FNR3015S430MT	43±20%	1.378	1.060	16	0.37	0.43	0.37	0.48
FNR3015S470MT	47±20%	1.625	1.250	14	0.35	0.43	0.35	0.44
FNR3015S560MT	56±20%	1.664	1.280	13	0.33	0.42	0.34	0.41
FNR3015S620MT	62±20%	2.093	1.610	13	0.30	0.40	0.30	0.41
FNR3015S680MT	68±20%	3.510	2.700	11	0.28	0.37	0.23	0.31
FNR3015S101MT	100±20%	4.043	3.110	6.3	0.23	0.25	0.21	0.25
FNR3015S151MT	150±20%	4.940	3.800	4.7	0.18	0.22	0.19	0.23

SPECIFICATIONS

FNR3021S Series

Part Number	Inductance	DC Resistance		Self-resonant Frequency	Saturation Current*3		Heat Rating Current*4	
	@100kHz,0.25V	Max.	Typ.	Min.	Max.	Typ.	Max.	Typ.
Units	μH	Ω		MHz	A		A	
Symbol	L	DCR		S.R.F	Isat		Irms	
FNR3021S1R0NT	1.0±30%	0.056	0.043	135	4.00	6.00	2.00	2.30
FNR3021S1R2NT	1.2±30%	0.060	0.047	99	3.80	4.10	1.95	2.25
FNR3021S1R5NT	1.5±30%	0.061	0.047	90	3.90	4.20	2.00	2.20
FNR3021S2R2NT	2.2±30%	0.091	0.070	75	3.20	3.70	1.85	2.00
FNR3021S3R3MT	3.3±20%	0.120	0.092	61	2.70	3.00	1.50	1.68
FNR3021S4R7MT	4.7±20%	0.156	0.120	44	2.20	2.70	1.20	1.35
FNR3021S6R8MT	6.8±20%	0.208	0.160	35	2.00	2.40	1.00	1.20
FNR3021S100MT	10±20%	0.312	0.240	37	1.40	1.80	0.93	1.10
FNR3021S220MT	22±20%	0.689	0.530	21	1.00	1.20	0.55	0.61
FNR3021S470MT	47±20%	1.300	1.000	13	0.70	0.88	0.40	0.45
FNR3021S151MT	150±20%	5.200	4.000	4	0.40	0.49	0.16	0.18

FNR4010S Series

Part Number	Inductance	DC Resistance		Self-resonant Frequency	Saturation Current*3		Heat Rating Current*4	
	@100kHz,1V	Max.	Typ.	Min.	Max.	Typ.	Max.	Typ.
Units	μH	Ω		MHz	A		A	
Symbol	L	DCR		S.R.F	Isat		Irms	
FNR4010S1R0NT	1.0±30%	0.067	0.056	116	2.00	2.30	1.90	2.40
FNR4010S1R5NT	1.5±30%	0.084	0.070	94	1.68	2.00	1.70	2.00
FNR4010S2R2MT	2.2±20%	0.102	0.085	73	1.20	1.50	1.50	2.00
FNR4010S3R3MT	3.3±20%	0.120	0.100	58	1.10	1.40	1.40	1.80
FNR4010S4R7MT	4.7±20%	0.168	0.140	47	0.95	1.10	1.20	1.50
FNR4010S6R8MT	6.8±20%	0.240	0.200	38	0.80	0.95	1.00	1.20
FNR4010S100MT	10±20%	0.360	0.300	31	0.62	0.75	0.75	1.00
FNR4010S150MT	15±20%	0.516	0.430	24	0.54	0.61	0.60	0.85
FNR4010S220MT	22±20%	0.684	0.570	19	0.45	0.52	0.50	0.75

FNR4012S Series

Part Number	Inductance	DC Resistance		Self-resonant Frequency	Saturation Current*3		Heat Rating Current*4	
	@100kHz,1V	Max.	Typ.	Min.	Max.	Typ.	Max.	Typ.
Units	μH	Ω		MHz	A		A	
Symbol	L	DCR		S.R.F	Isat		Irms	
FNR4012SR82NT	0.82±30%	0.065	0.050	150	3.02	3.30	1.65	2.50
FNR4012S1R0NT	1.0±30%	0.065	0.050	120	2.61	3.20	1.65	2.50
FNR4012S1R5NT	1.5±30%	0.085	0.065	90	2.10	2.70	1.46	2.20
FNR4012S1R8NT	1.8±30%	0.104	0.080	88	2.12	2.60	1.32	1.90
FNR4012S2R2NT	2.2±30%	0.104	0.080	74	1.76	2.30	1.32	1.90
FNR4012S2R7NT	2.7±30%	0.117	0.090	71	1.90	2.30	1.25	1.70
FNR4012S3R3NT	3.3±30%	0.143	0.110	60	1.72	2.10	1.12	1.60
FNR4012S3R6NT	3.6±30%	0.143	0.110	57	1.20	1.70	1.12	1.60

SPECIFICATIONS

FNR4012S Series

Part Number	Inductance	DC Resistance		Self-resonant Frequency	Saturation Current*3		Heat Rating Current*4	
	@100kHz, 1V	Max.	Typ.	Min.	Max.	Typ.	Max.	Typ.
Units	μH	Ω		MHz	A		A	
Symbol	L	DCR		S.R.F	Isat		Irms	
FNR4012S4R3NT	4.3±30%	0.182	0.140	54	1.58	1.70	1.00	1.50
FNR4012S4R7NT	4.7±30%	0.163	0.125	50	1.15	1.80	1.05	1.50
FNR4012S5R1NT	5.1±30%	0.201	0.155	50	1.55	1.60	0.95	1.50
FNR4012S5R6NT	5.6±30%	0.182	0.140	42	1.00	1.60	1.00	1.20
FNR4012S6R8MT	6.8±20%	0.257	0.198	40	0.85	1.40	0.84	1.20
FNR4012S100MT	10±20%	0.345	0.265	33	0.80	1.10	0.77	1.00
FNR4012S120MT	12±20%	0.377	0.290	32	0.66	1.00	0.70	0.95
FNR4012S150MT	15±20%	0.442	0.340	25	0.56	0.80	0.64	0.85
FNR4012S180MT	18±20%	0.611	0.470	23	0.55	0.75	0.55	0.80
FNR4012S220MT	22±20%	0.763	0.587	20	0.46	0.70	0.49	0.75
FNR4012S270MT	27±20%	0.936	0.720	18	0.50	0.70	0.45	0.60
FNR4012S330MT	33±20%	1.053	0.810	17	0.42	0.60	0.42	0.58
FNR4012S360MT	36±20%	1.170	0.900	14	0.40	0.50	0.40	0.56
FNR4012S390MT	39±20%	1.430	1.100	16	0.55	0.66	0.37	0.50
FNR4012S470MT	47±20%	1.430	1.100	12	0.35	0.50	0.37	0.50
FNR4012S560MT	56±20%	1.625	1.250	11	0.33	0.45	0.33	0.46
FNR4012S680MT	68±20%	2.535	1.950	11	0.38	0.45	0.27	0.45
FNR4012S820MT	82±20%	2.782	2.140	11	0.28	0.40	0.26	0.36
FNR4012S101MT	100±20%	2.873	2.210	9.4	0.25	0.30	0.25	0.35

FNR4015S Series

Part Number	Inductance	DC Resistance		Self-resonant Frequency	Saturation Current*3		Heat Rating Current*4	
	@100kHz, 0.25V	Max.	Typ.	Min.	Max.	Typ.	Max.	Typ.
Units	μH	Ω		MHz	A		A	
Symbol	L	DCR		S.R.F	Isat		Irms	
FNR4015S1R0NT	1.0±30%	0.046	0.035	108	3.30	4.40	2.50	2.80
FNR4015S1R5NT	1.5±30%	0.052	0.040	81	2.70	3.50	2.20	2.50
FNR4015S2R2MT	2.2±20%	0.069	0.053	67	2.10	3.00	2.00	2.20
FNR4015S3R3MT	3.3±20%	0.098	0.075	54	1.90	2.60	1.80	2.00
FNR4015S4R7MT	4.7±20%	0.130	0.100	45	1.45	2.10	1.35	1.50
FNR4015S6R8MT	6.8±20%	0.176	0.135	36	1.30	1.60	1.20	1.35
FNR4015S100MT	10±20%	0.260	0.200	30	1.10	1.36	1.00	1.12
FNR4015S150MT	15±20%	0.390	0.300	23	0.90	1.10	0.85	0.96
FNR4015S220MT	22±20%	0.520	0.400	18	0.72	0.90	0.68	0.76
FNR4015S330MT	33±20%	0.858	0.660	14	0.63	0.76	0.58	0.65
FNR4015S470MT	47±20%	1.270	0.975	11	0.55	0.63	0.45	0.50
FNR4015S680MT	68±20%	2.080	1.600	10	0.50	0.58	0.42	0.47

SPECIFICATIONS

FNR4018S Series

Part Number	Inductance	DC Resistance		Self-resonant Frequency	Saturation Current*3		Heat Rating Current*4	
	@100kHz,1V	Max.	Typ.	Min.	Max.	Typ.	Max.	Typ.
Units	μH	Ω		MHz	A		A	
Symbol	L	DCR		S.R.F	Isat		Irms	
FNR4018SR47NT	0.47±30%	0.018	0.014	155	4.30	5.20	4.00	4.50
FNR4018SR68NT	0.68±30%	0.026	0.020	128	4.90	5.60	3.30	3.80
FNR4018S1R0NT	1.0±30%	0.033	0.025	80	4.80	5.20	2.00	3.30
FNR4018S1R5NT	1.5±30%	0.039	0.030	65	3.35	4.00	1.80	3.20
FNR4018S1R8NT	1.8±30%	0.044	0.034	54	3.00	3.40	2.00	2.80
FNR4018S2R2MT	2.2±20%	0.059	0.045	52	2.70	3.20	1.65	2.60
FNR4018S3R3MT	3.3±20%	0.091	0.070	44	2.45	2.90	1.23	2.10
FNR4018S4R7MT	4.7±20%	0.117	0.090	34	1.70	2.20	1.20	1.80
FNR4018S6R8MT	6.8±20%	0.143	0.110	29	1.45	2.00	1.06	1.50
FNR4018S100MT	10±20%	0.234	0.180	24	1.30	1.60	0.84	1.20
FNR4018S150MT	15±20%	0.325	0.250	19	0.94	1.10	0.65	1.00
FNR4018S220MT	22±20%	0.468	0.360	16	0.80	0.88	0.59	0.85
FNR4018S270MT	27±20%	0.611	0.470	27	0.47	0.62	0.52	0.90
FNR4018S330MT	33±20%	0.689	0.530	12	0.56	0.75	0.49	0.72
FNR4018S470MT	47±20%	0.845	0.650	10	0.57	0.70	0.42	0.65
FNR4018S680MT	68±20%	1.300	1.000	8.3	0.47	0.51	0.32	0.52
FNR4018S101MT	100±20%	2.275	1.750	6.5	0.40	0.44	0.25	0.41
FNR4018S151MT	150±20%	3.250	2.500	5.5	0.31	0.34	0.22	0.36
FNR4018S221MT	220±20%	5.200	4.000	4	0.27	0.30	0.17	0.27

FNR4020S Series

Part Number	Inductance	DC Resistance		Self-resonant Frequency	Saturation Current*3		Heat Rating Current*4	
	@100kHz,1V	Max.	Typ.	Min.	Max.	Typ.	Max.	Typ.
Units	μH	Ω		MHz	A		A	
Symbol	L	DCR		S.R.F	Isat		Irms	
FNR4020SR24MT	0.24±20%	0.014	0.011	283	10.5	12.5	4.50	5.20
FNR4020SR33NT	0.33±30%	0.016	0.013	223	7.50	8.50	3.30	4.90
FNR4020SR47NT	0.47±30%	0.029	0.022	160	7.00	7.50	3.30	3.70
FNR4020SR68NT	0.68±30%	0.036	0.028	120	6.40	6.60	2.80	3.30
FNR4020S1R0NT	1.0±30%	0.038	0.029	75	4.78	5.20	2.15	3.20
FNR4020S1R2NT	1.2±30%	0.038	0.029	72	5.10	5.60	2.15	3.20
FNR4020S1R5NT	1.5±30%	0.046	0.035	71	4.45	4.90	1.98	3.00
FNR4020S2R2NT	2.2±30%	0.052	0.040	49	3.40	3.70	1.85	2.80
FNR4020S3R3MT	3.3±20%	0.091	0.070	44	3.20	3.50	1.40	2.50
FNR4020S3R6MT	3.6±20%	0.072	0.055	49	2.80	3.00	1.54	2.50
FNR4020S4R7MT	4.7±20%	0.098	0.075	42	2.35	2.50	1.34	2.00
FNR4020S5R1MT	5.1±20%	0.111	0.085	42	2.30	2.50	1.27	1.80
FNR4020S5R6MT	5.6±20%	0.117	0.090	30	2.20	2.40	1.22	1.80
FNR4020S6R2MT	6.2±20%	0.150	0.115	36	2.15	2.30	1.08	1.60
FNR4020S6R8MT	6.8±20%	0.163	0.125	33	2.20	2.40	1.04	1.60
FNR4020S7R5MT	7.5±20%	0.150	0.115	30	1.85	2.00	1.08	1.50
FNR4020S8R2MT	8.2±20%	0.163	0.125	27	1.75	1.90	1.04	1.40
FNR4020S100MT	10±20%	0.215	0.165	26	1.60	1.70	0.90	1.20
FNR4020S120MT	12±20%	0.228	0.175	26	1.50	1.60	0.88	1.20
FNR4020S150MT	15±20%	0.299	0.230	24	1.35	1.50	0.77	1.10
FNR4020S220MT	22±20%	0.455	0.350	15	1.05	1.10	0.62	0.87
FNR4020S270MT	27±20%	0.709	0.545	14	1.02	1.10	0.50	0.70

SPECIFICATIONS

FNR4020S Series

Part Number	Inductance	DC Resistance		Self-resonant Frequency	Saturation Current*3		Heat Rating Current*4	
	@100kHz, 1V	Max.	Typ.	Min.	Max.	Typ.	Max.	Typ.
Units	μH	Ω		MHz	A		A	
Symbol	L	DCR		S.R.F	Isat		Irms	
FNR4020S330MT	33±20%	0.715	0.550	11	0.85	0.93	0.49	0.68
FNR4020S390MT	39±20%	0.845	0.650	11	0.82	0.90	0.46	0.64
FNR4020S430MT	43±20%	0.858	0.660	10	0.77	0.85	0.45	0.63
FNR4020S470MT	47±20%	0.923	0.710	10	0.74	0.81	0.44	0.61
FNR4020S510MT	51±20%	0.975	0.750	10	0.70	0.77	0.42	0.59
FNR4020S560MT	56±20%	1.040	0.800	10	0.66	0.72	0.41	0.57
FNR4020S620MT	62±20%	1.170	0.900	9.6	0.65	0.71	0.39	0.52
FNR4020S680MT	68±20%	1.380	1.060	7.7	0.61	0.67	0.36	0.50
FNR4020S750MT	75±20%	1.510	1.160	7.7	0.70	0.77	0.35	0.49
FNR4020S820MT	82±20%	1.520	1.170	7.2	0.50	0.55	0.34	0.47
FNR4020S101MT	100±20%	2.020	1.550	6.3	0.48	0.53	0.31	0.43

FNR4026S Series

Part Number	Inductance	DC Resistance		Self-resonant Frequency	Saturation Current*3		Heat Rating Current*4	
	@100kHz, 1V	Max.	Typ.	Min.	Max.	Typ.	Max.	Typ.
Units	μH	Ω		MHz	A		A	
Symbol	L	DCR		S.R.F	Isat		Irms	
FNR4026S1R0NT	1.0±30%	0.031	0.024	151	3.30	3.80	3.00	3.30
FNR4026S1R2NT	1.2±30%	0.039	0.030	120	3.10	3.40	2.30	3.30
FNR4026S1R5NT	1.5±30%	0.039	0.030	100	2.40	2.90	2.30	3.10
FNR4026S2R2MT	2.2±20%	0.052	0.040	96	2.10	2.40	2.00	3.80
FNR4026S3R3MT	3.3±20%	0.065	0.050	58	1.80	2.00	1.70	2.50
FNR4026S4R7MT	4.7±20%	0.072	0.055	46	1.45	1.70	1.60	2.30
FNR4026S6R8MT	6.8±20%	0.085	0.065	33	1.30	1.50	1.50	2.00
FNR4026S100MT	10±20%	0.110	0.085	26	1.00	1.20	1.30	1.90
FNR4026S150MT	15±20%	0.143	0.110	19	0.90	1.00	1.10	1.50
FNR4026S220MT	22±20%	0.214	0.165	13	0.60	0.80	0.90	1.40
FNR4026S330MT	33±20%	0.351	0.270	9	0.55	0.65	0.70	1.00
FNR4026S470MT	47±20%	0.390	0.300	6	0.40	0.55	0.65	0.90

FNR4030S Series

Part Number	Inductance	DC Resistance		Self-resonant Frequency	Saturation Current*3		Heat Rating Current*4	
	@100kHz, 1V	Max.	Typ.	Min.	Max.	Typ.	Max.	Typ.
Units	μH	Ω		MHz	A		A	
Symbol	L	DCR		S.R.F	Isat		Irms	
FNR4030SR68NT	0.68±30%	0.013	0.010	130	6.80	8.00	4.56	5.10
FNR4030SR91NT	0.91±30%	0.017	0.013	100	6.25	6.80	4.15	4.70
FNR4030S1R0NT	1.0±30%	0.018	0.014	70	5.26	5.70	4.15	4.70
FNR4030S1R2NT	1.2±30%	0.020	0.015	80	5.80	6.30	3.82	4.20
FNR4030S1R5NT	1.5±30%	0.026	0.020	62	4.84	5.30	3.34	3.60
FNR4030S1R8NT	1.8±30%	0.033	0.025	60	5.40	5.80	3.20	3.30
FNR4030S2R2NT	2.2±30%	0.039	0.030	52	4.90	5.80	2.95	3.20
FNR4030S3R3MT	3.3±20%	0.052	0.040	38	3.30	3.60	2.40	2.60
FNR4030S3R6MT	3.6±20%	0.052	0.040	37	3.00	3.50	2.40	2.60
FNR4030S3R9MT	3.9±20%	0.074	0.057	32	3.00	3.30	2.10	2.30

SPECIFICATIONS

FNR4030S Series

Part Number	Inductance	DC Resistance		Self-resonant Frequency	Saturation Current*3		Heat Rating Current*4	
	@100kHz,1V	Max.	Typ.	Min.	Max.	Typ.	Max.	Typ.
Units	μH	Ω		MHz	A		A	
Symbol	L	DCR		S.R.F	Isat		Irms	
FNR4030S4R3MT	4.3±20%	0.072	0.055	37	2.95	3.20	2.10	2.30
FNR4030S4R7MT	4.7±20%	0.078	0.060	31	2.90	3.20	2.00	2.30
FNR4030S5R6MT	5.6±20%	0.085	0.065	30	2.60	2.80	1.95	2.10
FNR4030S6R8MT	6.8±20%	0.117	0.090	24	2.75	3.00	1.60	1.70
FNR4030S7R5MT	7.5±20%	0.110	0.085	26	2.20	2.40	1.65	1.80
FNR4030S8R2MT	8.2±20%	0.117	0.090	26	2.10	2.30	1.60	1.70
FNR4030S100MT	10±20%	0.130	0.100	21	1.95	2.40	1.50	1.60
FNR4030S120MT	12±20%	0.175	0.135	18	1.70	1.80	1.30	1.40
FNR4030S150MT	15±20%	0.247	0.190	16	1.65	1.80	1.11	1.20
FNR4030S180MT	18±20%	0.260	0.200	10	1.40	1.50	1.10	1.20
FNR4030S220MT	22±20%	0.292	0.225	10	1.30	1.40	1.00	1.20
FNR4030S270MT	27±20%	0.338	0.260	10	1.15	1.35	0.90	1.05
FNR4030S330MT	33±20%	0.429	0.330	10	1.10	1.20	0.84	0.92
FNR4030S360MT	36±20%	0.436	0.335	9.8	1.05	1.10	0.83	0.91
FNR4030S390MT	39±20%	0.566	0.435	10	1.03	1.10	0.73	0.80
FNR4030S470MT	47±20%	0.579	0.445	8.4	0.95	1.00	0.72	0.80
FNR4030S510MT	51±20%	0.611	0.470	8.4	0.90	1.13	0.70	0.80
FNR4030S560MT	56±20%	0.722	0.555	8.4	0.85	0.94	0.65	0.71
FNR4030S620MT	62±20%	0.761	0.585	7	0.80	0.99	0.63	0.70
FNR4030S680MT	68±20%	1.128	0.868	7	0.72	0.80	0.52	0.57
FNR4030S750MT	75±20%	1.326	1.020	6.3	0.70	0.88	0.48	0.53
FNR4030S820MT	82±20%	1.378	1.060	5.6	0.66	0.72	0.47	0.52
FNR4030S910MT	91±20%	1.430	1.100	5.6	0.65	0.71	0.46	0.50
FNR4030S101MT	100±20%	1.495	1.150	5.6	0.60	0.73	0.45	0.49
FNR4030S121MT	120±20%	1.755	1.350	5.4	0.55	0.60	0.42	0.46
FNR4030S151MT	150±20%	2.340	1.800	4	0.50	0.55	0.30	0.35
FNR4030S221MT	220±20%	3.250	2.500	4.2	0.40	0.50	0.35	0.40
FNR4030S331MT	330±20%	5.200	4.000	6.8	0.30	0.40	0.25	0.26
FNR4030S471KT	470±10%	9.360	7.200	2	0.30	0.35	0.20	0.23
FNR4030S501MT	500±20%	9.027	6.944	2	0.28	0.30	0.15	0.20
FNR4030S681MT	680±20%	9.854	7.580	1.2	0.19	0.20	0.14	0.18

FNR5012S Series

Part Number	Inductance	DC Resistance		Self-resonant Frequency	Saturation Current*3		Heat Rating Current*4	
	@100kHz,1V	Max.	Typ.	Min.	Max.	Typ.	Max.	Typ.
Units	μH	Ω		MHz	A		A	
Symbol	L	DCR		S.R.F	Isat		Irms	
FNR5012SR22NT	0.22±30%	0.034	0.028	315	8.10	9.30	3.00	3.30
FNR5012S1R0NT	1.0±30%	0.068	0.057	103	4.40	4.70	2.00	2.40
FNR5012S1R5NT	1.5±30%	0.086	0.072	68	3.70	3.80	1.90	2.20
FNR5012S2R2NT	2.2±30%	0.108	0.090	50	3.10	3.20	1.70	2.00
FNR5012S3R3NT	3.3±30%	0.151	0.126	34	2.40	2.60	1.40	1.70
FNR5012S4R7NT	4.7±30%	0.197	0.164	31	2.20	2.30	1.30	1.50
FNR5012S6R8MT	6.8±20%	0.294	0.245	22	1.70	1.90	1.00	1.20
FNR5012S100MT	10±20%	0.413	0.344	17	1.40	1.50	0.85	1.00
FNR5012S150MT	15±20%	0.523	0.436	13	1.20	1.30	0.80	0.92
FNR5012S220MT	22±20%	0.858	0.780	16	0.88	0.98	0.60	0.68

SPECIFICATIONS

FNR5015S Series

Part Number	Inductance	DC Resistance		Self-resonant Frequency	Saturation Current*3		Heat Rating Current*4	
	@100kHz,0.25V	Max.	Typ.	Min.	Max.	Typ.	Max.	Typ.
Units	μH	Ω		MHz	A		A	
Symbol	L	DCR		S.R.F	Isat		Irms	
FNR5015SR22NT	0.22±30%	0.026	0.020	284	7.60	9.60	3.50	4.00
FNR5015SR68NT	0.68±30%	0.036	0.028	108	6.00	6.60	2.90	3.20
FNR5015S1R0NT	1.0±30%	0.046	0.035	93	4.50	5.00	2.80	3.10
FNR5015S1R5NT	1.5±30%	0.065	0.050	62	3.50	4.60	2.50	2.80
FNR5015S2R2NT	2.2±30%	0.085	0.065	45	3.00	3.80	2.20	2.50
FNR5015S3R3NT	3.3±30%	0.104	0.080	31	2.50	3.00	1.90	2.10
FNR5015S4R7NT	4.7±30%	0.130	0.100	28	2.10	2.80	1.60	1.80
FNR5015S6R8MT	6.8±20%	0.195	0.150	20	1.65	2.10	1.40	1.60
FNR5015S100MT	10±20%	0.260	0.200	15	1.45	1.60	1.20	1.35
FNR5015S150MT	15±20%	0.416	0.320	12	1.20	1.20	0.85	0.96
FNR5015S220MT	22±20%	0.585	0.450	15	1.00	1.20	0.75	0.85
FNR5015S330MT	33±20%	1.010	0.780	9	0.95	1.10	0.58	0.65
FNR5015S470MT	47±20%	1.560	1.200	6	0.88	0.95	0.40	0.45
FNR5015S680MT	68±20%	2.470	1.900	5	0.72	0.80	0.35	0.39

FNR5020S Series

Part Number	Inductance	DC Resistance		Self-resonant Frequency	Saturation Current*3		Heat Rating Current*4	
	@100kHz,1V	Max.	Typ.	Min.	Max.	Typ.	Max.	Typ.
Units	μH	Ω		MHz	A		A	
Symbol	L	DCR		S.R.F	Isat		Irms	
FNR5020SR22NT	0.22±30%	0.011	0.009	280	9.00	12.00	5.30	6.00
FNR5020SR24NT	0.24±30%	0.011	0.009	248	8.00	10.00	5.30	6.00
FNR5020SR47NT	0.47±30%	0.017	0.013	160	6.15	6.70	4.60	5.00
FNR5020SR56NT	0.56±30%	0.022	0.017	137	8.50	9.60	3.80	4.20
FNR5020SR68NT	0.68±30%	0.022	0.017	120	5.50	6.00	4.00	4.40
FNR5020SR75NT	0.75±30%	0.022	0.017	117	5.50	6.00	4.00	4.40
FNR5020S1R0NT	1.0±30%	0.026	0.020	114	4.10	5.00	3.80	4.10
FNR5020S1R2NT	1.2±30%	0.029	0.022	83	4.50	4.90	3.55	3.90
FNR5020S1R5NT	1.5±30%	0.034	0.026	68	4.10	4.50	3.20	3.50
FNR5020S2R2NT	2.2±30%	0.042	0.032	57	3.20	4.00	2.90	3.10
FNR5020S2R7NT	2.7±30%	0.049	0.038	52	2.90	3.50	2.70	2.90
FNR5020S3R0NT	3.0±30%	0.049	0.038	49	2.55	2.80	2.70	2.90
FNR5020S3R3NT	3.3±30%	0.056	0.043	46	2.55	3.00	2.50	2.70
FNR5020S3R6NT	3.6±30%	0.056	0.043	43	2.80	3.00	2.50	2.70
FNR5020S3R9NT	3.9±30%	0.056	0.043	40	2.30	2.80	2.50	2.70
FNR5020S4R3MT	4.3±20%	0.074	0.057	37	2.50	3.00	2.20	2.40
FNR5020S4R7MT	4.7±20%	0.074	0.057	37	2.50	2.70	2.20	2.40
FNR5020S5R1MT	5.1±20%	0.083	0.064	32	2.25	2.60	2.05	2.20
FNR5020S5R6MT	5.6±20%	0.083	0.064	32	2.30	2.50	2.05	2.20
FNR5020S6R8MT	6.8±20%	0.108	0.083	30	2.05	2.20	1.80	1.90

SPECIFICATIONS

FNR5020S Series

Part Number	Inductance	DC Resistance		Self-resonant Frequency	Saturation Current*3		Heat Rating Current*4	
	@100kHz,1V	Max.	Typ.	Min.	Max.	Typ.	Max.	Typ.
Units	μH	Ω		MHz	A		A	
Symbol	L	DCR		S.R.F	Isat		Irms	
FNR5020S7R5MT	7.5±20%	0.117	0.090	26	1.85	2.00	1.75	1.90
FNR5020S8R2MT	8.2±20%	0.127	0.098	26	1.85	2.00	1.65	1.80
FNR5020S9R1MT	9.1±20%	0.143	0.110	24	1.70	1.80	1.55	1.70
FNR5020S100MT	10±20%	0.143	0.110	24	1.70	1.80	1.55	1.70
FNR5020S120MT	12±20%	0.182	0.140	22	1.50	1.60	1.40	1.50
FNR5020S150MT	15±20%	0.215	0.165	20	1.35	1.40	1.25	1.30
FNR5020S180MT	18±20%	0.260	0.200	16	1.25	1.30	1.15	1.20
FNR5020S220MT	22±20%	0.294	0.226	14	1.15	1.20	1.10	1.20
FNR5020S330MT	33±20%	0.507	0.390	10	0.92	1.00	0.90	0.99
FNR5020S470MT	47±20%	0.680	0.523	7	0.77	0.84	0.77	0.84
FNR5020S560MT	56±20%	0.819	0.630	6	0.77	0.84	0.70	0.77
FNR5020S680MT	68±20%	0.962	0.740	6	0.65	0.70	0.64	0.70
FNR5020S820MT	82±20%	1.158	0.965	6	0.65	0.75	0.50	0.60
FNR5020S101MT	100±20%	1.430	1.100	6	0.53	0.58	0.53	0.58
FNR5020S121MT	120±20%	1.755	1.350	6	0.42	0.53	0.40	0.50
FNR5020S201MT	200±20%	2.600	2.000	4.5	0.30	0.33	0.40	0.45

FNR5030S Series

Part Number	Inductance	DC Resistance		Self-resonant Frequency	Saturation Current*3		Heat Rating Current*4	
	@100kHz,0.25V	Max.	Typ.	Min.	Max.	Typ.	Max.	Typ.
Units	μH	Ω		MHz	A		A	
Symbol	L	DCR		S.R.F	Isat		Irms	
FNR5030SR47NT	0.47±30%	0.013	0.010	144	9.00	11.0	5.00	5.60
FNR5030S1R0NT	1.0±30%	0.020	0.015	103	6.65	7.80	4.00	4.50
FNR5030S1R5NT	1.5±30%	0.021	0.016	61	4.80	6.00	3.90	4.36
FNR5030S2R2MT	2.2±20%	0.030	0.023	52	4.20	5.00	3.50	3.95
FNR5030S3R3MT	3.3±20%	0.039	0.030	42	3.60	4.60	3.00	3.40
FNR5030S4R7MT	4.7±20%	0.046	0.035	33	3.10	3.50	2.60	2.90
FNR5030S6R8MT	6.8±20%	0.068	0.052	27	2.50	3.00	2.30	2.60
FNR5030S100MT	10±20%	0.091	0.070	22	1.90	2.30	1.70	1.90
FNR5030S150MT	15±20%	0.163	0.125	18	1.60	1.80	1.40	1.60
FNR5030S220MT	22±20%	0.234	0.180	13	1.40	1.50	1.05	1.20
FNR5030S270MT	27±20%	0.247	0.190	10	1.30	1.40	0.90	1.00
FNR5030S330MT	33±20%	0.293	0.225	9	1.15	1.30	0.80	0.90
FNR5030S470MT	47±20%	0.423	0.325	6	0.95	1.10	0.70	0.78
FNR5030S560MT	56±20%	0.546	0.420	5	0.89	0.92	0.65	0.70
FNR5030S680MT	68±20%	0.618	0.475	5	0.85	0.90	0.60	0.76
FNR5030S101MT	100±20%	0.936	0.720	5	0.58	0.70	0.59	0.75
FNR5030S151MT	150±20%	1.370	1.050	3	0.56	0.68	0.55	0.60
FNR5030S221MT	220±20%	1.690	1.300	3	0.50	0.60	0.45	0.51

SPECIFICATIONS

FNR5040S Series

Part Number	Inductance	DC Resistance		Self-resonant Frequency	Saturation Current*3		Heat Rating Current*4	
	@100kHz, 1V	Max.	Typ.	Min.	Max.	Typ.	Max.	Typ.
Units	μH	Ω		MHz	A		A	
Symbol	L	DCR		S.R.F	Isat		Irms	
FNR5040SR22MT	0.22±20%	0.008	0.006	289	18.00	20.00	6.50	7.50
FNR5040SR24NT	0.24±30%	0.008	0.006	251	15.70	18.00	6.40	7.40
FNR5040SR47MT	0.47±20%	0.009	0.007	171	10.00	11.50	6.60	7.60
FNR5040S1R0NT	1.0±30%	0.016	0.012	117	7.35	8.00	4.90	5.00
FNR5040S1R2NT	1.2±30%	0.021	0.016	110	6.50	7.00	4.15	4.25
FNR5040S1R5NT	1.5±30%	0.020	0.015	86	6.30	6.80	4.30	4.85
FNR5040S1R8MT	1.8±20%	0.021	0.016	55	5.50	6.05	4.15	4.30
FNR5040S2R2NT	2.2±30%	0.025	0.019	50	4.90	5.50	3.80	4.20
FNR5040S2R7NT	2.7±30%	0.029	0.022	37	4.30	4.80	3.60	4.00
FNR5040S3R0NT	3.0±30%	0.029	0.022	37	4.15	4.60	3.60	4.00
FNR5040S3R3NT	3.3±30%	0.031	0.024	32	3.95	4.45	3.40	3.90
FNR5040S3R6MT	3.6±20%	0.034	0.026	30	3.80	4.40	3.30	3.70
FNR5040S3R9NT	3.9±30%	0.035	0.027	29	3.55	4.00	3.20	3.70
FNR5040S4R7NT	4.7±30%	0.039	0.030	28	3.50	3.80	3.00	3.30
FNR5040S5R6MT	5.6±20%	0.046	0.035	27	3.00	3.70	2.80	3.10
FNR5040S6R8MT	6.8±20%	0.056	0.043	21	2.90	3.40	2.50	2.80
FNR5040S8R2MT	8.2±20%	0.062	0.048	20	2.70	2.90	2.30	2.60
FNR5040S100MT	10±20%	0.083	0.064	18	2.35	2.70	2.10	2.35
FNR5040S120MT	12±20%	0.100	0.077	14	2.2	2.5	2.0	2.1
FNR5040S150MT	15±20%	0.112	0.086	13	2.00	2.20	2.00	2.05
FNR5040S180MT	18±20%	0.155	0.119	12	1.70	2.00	1.45	1.65
FNR5040S220MT	22±20%	0.168	0.129	11	1.60	1.80	1.50	1.60
FNR5040S270MT	27±20%	0.244	0.188	9.8	1.52	1.75	1.10	1.25
FNR5040S330MT	33±20%	0.244	0.188	9	1.30	1.45	1.20	1.35
FNR5040S470MT	47±20%	0.354	0.272	7	1.10	1.20	1.00	1.15
FNR5040S510MT	51±20%	0.494	0.380	6	1.00	1.20	1.00	1.10
FNR5040S560MT	56±20%	0.494	0.380	6	1.05	1.20	0.80	0.90
FNR5040S680MT	68±20%	0.520	0.400	6	0.90	1.00	0.80	0.90
FNR5040S750MT	75±20%	0.585	0.450	6	0.85	0.95	0.72	0.80
FNR5040S101MT	100±20%	0.728	0.560	5	0.75	0.85	0.70	0.78
FNR5040S151MT	150±20%	0.975	0.750	3.7	0.65	0.67	0.60	0.70
FNR5040S221MT	220±20%	1.820	1.400	3.0	0.48	0.55	0.40	0.50
FNR5040S301MT	300±20%	2.600	2.000	2.7	0.50	0.58	0.35	0.40
FNR5040S331MT	330±20%	2.730	2.100	2.7	0.42	0.47	0.40	0.50
FNR5040S471MT	470±20%	3.900	3.000	2.7	0.37	0.43	0.35	0.40
FNR5040S561MT	560±20%	4.920	3.780	1.3	0.31	0.36	0.31	0.35
FNR5040S681MT	680±20%	5.070	3.900	1.3	0.30	0.35	0.25	0.30
FNR5040S102MT	1000±20%	7.800	6.000	1.3	0.21	0.25	0.20	0.23
FNR5040S332MT	3300±20%	25.20	21.00	0.9	0.140	0.150	0.100	0.120
FNR5040S392MT	3900±20%	30.55	23.50	0.8	0.125	0.150	0.100	0.115
FNR5040S472MT	4700±20%	45.50	35.00	0.6	0.110	0.130	0.080	0.100
FNR5040S502MT	5000±20%	43.16	35.97	0.49	0.110	0.130	0.085	0.098
FNR5040S562MT	5600±20%	50.70	39.00	0.49	0.105	0.120	0.080	0.092
FNR5040S682MT	6800±20%	55.90	43.00	0.38	0.090	0.110	0.075	0.086
FNR5040S822MT	8200±20%	55.90	43.00	0.38	0.070	0.085	0.075	0.086
FNR5040S103MT	10000±20%	58.50	45.00	0.32	0.065	0.075	0.075	0.086

SPECIFICATIONS

FNR5045S Series

Part Number	Inductance	DC Resistance		Self-resonant Frequency	Saturation Current*3		Heat Rating Current*4	
	@100kHz,1V	Max.	Typ.	Min.	Max.	Typ.	Max.	Typ.
Units	μH	Ω		MHz	A		A	
Symbol	L	DCR		S.R.F	Isat		Irms	
FNR5045S2R2MT	2.2±20%	0.029	0.022	50	6.40	7.20	4.70	5.40
FNR5045S100MT	10±20%	0.079	0.061	17	3.20	3.70	2.50	2.90
FNR5045S220MT	22±20%	0.163	0.125	10	2.00	2.35	1.55	1.80

FNR6020S Series

Part Number	Inductance	DC Resistance		Self-resonant Frequency	Saturation Current*3		Heat Rating Current*4	
	@100kHz,1V	Max.	Typ.	Min.	Max.	Typ.	Max.	Typ.
Units	μH	Ω		MHz	A		A	
Symbol	L	DCR		S.R.F	Isat		Irms	
FNR6020SR50NT	0.50±30%	0.018	0.014	120	4.50	6.00	4.00	5.00
FNR6020SR68NT	0.68±30%	0.022	0.017	115	6.55	7.80	3.80	4.80
FNR6020SR82NT	0.82±30%	0.022	0.017	110	5.30	6.30	3.80	4.80
FNR6020S1R0NT	1.0±30%	0.020	0.020	100	4.15	5.00	3.50	4.40
FNR6020S1R2NT	1.2±30%	0.029	0.022	88	5.90	7.00	3.20	4.00
FNR6020S1R5NT	1.5±30%	0.029	0.022	79	4.25	5.10	3.20	4.00
FNR6020S1R8NT	1.8±30%	0.036	0.028	68	4.85	5.80	2.75	3.50
FNR6020S2R0NT	2.0±30%	0.046	0.035	65	4.10	4.90	2.60	3.30
FNR6020S2R2NT	2.2±30%	0.036	0.028	61	3.75	4.50	2.75	3.50
FNR6020S2R7NT	2.7±30%	0.046	0.035	56	3.90	4.60	2.60	3.30
FNR6020S3R3NT	3.3±30%	0.046	0.035	51	3.15	3.70	2.60	3.30
FNR6020S3R9NT	3.9±30%	0.064	0.049	45	3.25	3.90	2.10	2.60
FNR6020S4R3NT	4.3±30%	0.064	0.049	44	2.70	3.20	2.10	2.60
FNR6020S4R7NT	4.7±30%	0.075	0.058	41	3.00	3.60	2.00	2.50
FNR6020S5R6NT	5.6±30%	0.075	0.058	36	2.40	2.90	1.90	2.40
FNR6020S6R2NT	6.2±30%	0.103	0.079	31	2.30	2.70	1.80	2.30
FNR6020S6R8NT	6.8±30%	0.103	0.079	31	2.20	2.60	1.80	2.30
FNR6020S8R2NT	8.2±30%	0.137	0.105	27	2.10	2.50	1.40	1.80
FNR6020S100MT	10±20%	0.137	0.105	27	1.75	2.10	1.40	1.80
FNR6020S120MT	12±20%	0.156	0.120	25	1.45	1.70	1.30	1.60
FNR6020S150MT	15±20%	0.189	0.145	21	1.20	1.40	1.20	1.50
FNR6020S180MT	18±20%	0.234	0.180	18	1.20	1.40	1.08	1.40
FNR6020S220MT	22±20%	0.265	0.204	16	1.05	1.20	1.00	1.30
FNR6020S330MT	33±20%	0.390	0.300	11	0.95	1.10	0.84	1.05
FNR6020S470MT	47±20%	0.559	0.430	10	0.70	0.90	0.80	0.90
FNR6020S331MT	330±20%	3.419	2.630	3	0.27	0.33	0.33	0.39

FNR6028S Series

Part Number	Inductance	DC Resistance		Self-resonant Frequency	Saturation Current*3		Heat Rating Current*4	
	@100kHz,1V	Max.	Typ.	Min.	Max.	Typ.	Max.	Typ.
Units	μH	Ω		MHz	A		A	
Symbol	L	DCR		S.R.F	Isat		Irms	
FNR6028SR82NT	0.82±30%	0.016	0.012	97	6.50	9.00	5.20	6.00
FNR6028S1R0NT	1.0±30%	0.013	0.010	70	5.75	7.00	5.20	5.70
FNR6028S1R2NT	1.2±30%	0.017	0.013	69	6.40	7.50	4.58	5.00
FNR6028S1R5NT	1.5±30%	0.017	0.013	65	6.00	6.60	4.58	5.00
FNR6028S2R2NT	2.2±30%	0.026	0.020	48	5.10	5.60	3.75	4.10
FNR6028S2R7NT	2.7±30%	0.026	0.020	48	3.80	4.10	3.75	4.10

Specifications subject to change without notice. Please check our website for latest informations.

SPECIFICATIONS

FNR6028S Series

Part Number	Inductance	DC Resistance		Self-resonant Frequency	Saturation Current*3		Heat Rating Current*4	
	@100kHz, 1V	Max.	Typ.	Min.	Max.	Typ.	Max.	Typ.
Units	μH	Ω		MHz	A		A	
Symbol	L	DCR		S.R.F	Isat		Irms	
FNR6028S3R3NT	3.3±30%	0.033	0.025	41	4.15	4.50	3.48	3.80
FNR6028S4R7NT	4.7±30%	0.039	0.030	35	3.00	3.30	3.08	3.40
FNR6028S5R1NT	5.1±30%	0.056	0.043	32	3.20	3.50	2.60	2.80
FNR6028S6R2MT	6.2±20%	0.061	0.047	30	3.05	3.30	2.40	2.60
FNR6028S6R8MT	6.8±20%	0.061	0.047	27	2.60	3.00	2.40	2.60
FNR6028S8R2MT	8.2±20%	0.072	0.055	24	2.30	2.50	2.25	2.50
FNR6028S9R1MT	9.1±20%	0.096	0.074	24	2.55	2.80	2.15	2.40
FNR6028S100MT	10±20%	0.094	0.072	23	2.04	2.50	1.95	2.40
FNR6028S120MT	12±20%	0.104	0.080	18	1.80	2.00	1.85	2.00
FNR6028S150MT	15±20%	0.163	0.125	18	1.75	1.90	1.45	1.60
FNR6028S180MT	18±20%	0.156	0.120	15	1.52	1.80	1.45	1.60
FNR6028S220MT	22±20%	0.182	0.140	14	1.45	1.80	1.40	1.60
FNR6028S270MT	27±20%	0.202	0.155	13	1.50	1.60	1.32	1.40
FNR6028S330MT	33±20%	0.241	0.185	12	1.35	1.50	1.22	1.30
FNR6028S360MT	36±20%	0.280	0.215	11	1.25	1.40	1.13	1.20
FNR6028S390MT	39±20%	0.293	0.225	11	1.25	1.40	1.10	1.20
FNR6028S470MT	47±20%	0.410	0.315	9.5	1.15	1.30	1.06	1.10
FNR6028S560MT	56±20%	0.449	0.345	8.2	1.05	1.20	0.89	1.00
FNR6028S680MT	68±20%	0.468	0.360	7.7	0.80	0.95	0.86	0.95
FNR6028S750MT	75±20%	0.533	0.410	7.7	0.90	0.99	0.81	0.90
FNR6028S820MT	82±20%	0.650	0.500	7.7	0.80	0.88	0.70	0.77
FNR6028S101MT	100±20%	0.650	0.500	7.1	0.65	0.71	0.70	0.77
FNR6028S401MT	400±20%	2.808	2.160	2.8	0.30	0.33	0.40	0.45
FNR6028S102MT	1000±20%	7.540	5.800	1.5	0.18	0.22	0.23	0.26

FNR6040S Series

Part Number	Inductance	DC Resistance		Self-resonant Frequency	Saturation Current*3		Heat Rating Current*4	
	@100kHz, 1V	Max.	Typ.	Min.	Max.	Typ.	Max.	Typ.
Units	μH	Ω		MHz	A		A	
Symbol	L	DCR		S.R.F	Isat		Irms	
FNR6040S1R0MT	1.0±20%	0.010	0.008	97	7.85	9.05	6.30	7.20
FNR6040S100MT	10±20%	0.062	0.048	16	3.20	3.50	2.45	2.80
FNR6040S120MT	12±20%	0.075	0.058	14	2.80	3.25	2.20	2.55
FNR6040S150MT	15±20%	0.088	0.068	13	2.50	3.00	2.05	2.35
FNR6040S220MT	22±20%	0.116	0.089	10	2.05	2.50	1.80	2.05
FNR6040S330MT	33±20%	0.178	0.137	9.9	1.65	2.00	1.45	1.65
FNR6040S680MT	68±20%	0.370	0.285	5.6	1.15	1.40	0.95	1.10
FNR6040S471MT	470±20%	2.500	1.790	2.0	0.42	0.50	0.47	0.55

SPECIFICATIONS

FNR6045S Series

Part Number	Inductance	DC Resistance		Self-resonant Frequency	Saturation Current*3		Heat Rating Current*4	
	@100kHz,1V	Max.	Typ.	Min.	Max.	Typ.	Max.	Typ.
Units	μH	Ω		MHz	A		A	
Symbol	L	DCR		S.R.F	Isat		Irms	
FNR6045SR47NT	0.47±30%	0.008	0.006	155	15.00	16.50	6.50	6.60
FNR6045SR56NT	0.56±30%	0.008	0.006	142	14.00	15.00	6.50	7.50
FNR6045SR68NT	0.68±30%	0.008	0.006	99	11.00	12.00	5.70	6.50
FNR6045SR82NT	0.82±30%	0.010	0.008	140	10.35	11.00	5.90	6.50
FNR6045S1R0NT	1.0±30%	0.014	0.011	100	9.85	10.00	5.14	5.60
FNR6045S1R2NT	1.2±30%	0.013	0.010	100	8.35	9.10	5.40	5.90
FNR6045S1R3NT	1.3±30%	0.013	0.010	100	8.35	9.10	5.40	5.90
FNR6045S1R5NT	1.5±30%	0.016	0.012	65	8.80	9.70	4.95	5.40
FNR6045S1R8NT	1.8±30%	0.016	0.012	74	7.60	8.40	4.95	5.40
FNR6045S2R2NT	2.2±30%	0.018	0.014	52	6.75	7.40	4.60	5.00
FNR6045S2R3NT	2.3±30%	0.027	0.021	60	6.00	6.60	3.50	3.80
FNR6045S2R7NT	2.7±30%	0.020	0.015	38	5.75	6.30	4.30	4.70
FNR6045S3R0NT	3.0±30%	0.026	0.020	35	5.60	6.20	3.80	4.20
FNR6045S3R3NT	3.3±30%	0.027	0.021	32	5.90	6.20	3.70	4.00
FNR6045S3R6NT	3.6±30%	0.027	0.021	28	5.25	5.70	3.70	4.00
FNR6045S4R3MT	4.3±20%	0.030	0.023	23	4.45	4.90	3.50	3.80
FNR6045S4R5MT	4.5±20%	0.034	0.026	24	4.97	5.50	3.30	3.60
FNR6045S4R7MT	4.7±20%	0.034	0.026	24	4.97	5.50	3.30	3.60
FNR6045S5R1MT	5.1±20%	0.034	0.026	23	4.40	4.80	3.30	3.60
FNR6045S5R6MT	5.6±20%	0.038	0.029	23	4.15	4.60	3.15	3.40
FNR6045S6R2MT	6.2±20%	0.040	0.031	26	4.43	4.80	3.00	3.30
FNR6045S6R3MT	6.3±20%	0.040	0.031	26	4.43	4.70	3.00	3.30
FNR6045S6R8MT	6.8±20%	0.040	0.031	20	3.90	4.30	3.00	3.30
FNR6045S7R5MT	7.5±20%	0.044	0.034	18	3.50	3.80	2.90	3.20
FNR6045S8R2MT	8.2±20%	0.056	0.043	21	3.90	4.30	2.60	2.80
FNR6045S9R1MT	9.1±20%	0.056	0.043	17	3.35	3.70	2.60	2.80
FNR6045S100MT	10±20%	0.062	0.048	15	3.20	3.50	2.45	2.70
FNR6045S120MT	12±20%	0.075	0.058	13	2.80	3.00	2.20	2.40
FNR6045S150MT	15±20%	0.088	0.068	12	2.50	2.70	2.05	2.20
FNR6045S180MT	18±20%	0.105	0.081	10	2.20	2.40	1.85	2.00
FNR6045S220MT	22±20%	0.116	0.089	10	2.05	2.20	1.80	2.00
FNR6045S270MT	27±20%	0.133	0.102	9.2	1.90	2.10	1.65	1.80
FNR6045S300MT	30±20%	0.172	0.132	7.8	1.70	1.80	1.50	1.60
FNR6045S330MT	33±20%	0.178	0.137	7.8	1.65	1.80	1.45	1.60
FNR6045S360MT	36±20%	0.225	0.173	7.8	1.62	1.80	1.40	1.50
FNR6045S390MT	39±20%	0.234	0.180	7.8	1.50	1.60	1.25	1.40
FNR6045S430MT	43±20%	0.260	0.200	7.7	1.63	1.80	1.20	1.30
FNR6045S470MT	47±20%	0.260	0.200	6.4	1.40	1.50	1.20	1.30
FNR6045S510MT	51±20%	0.269	0.207	6.4	1.35	1.50	1.15	1.20
FNR6045S560MT	56±20%	0.287	0.221	6.4	1.30	1.40	1.10	1.20
FNR6045S620MT	62±20%	0.306	0.235	6.4	1.25	1.40	1.10	1.20
FNR6045S680MT	68±20%	0.376	0.289	6.4	1.20	1.30	1.00	1.10
FNR6045S750MT	75±20%	0.397	0.305	5	1.15	1.20	0.95	1.00
FNR6045S820MT	82±20%	0.443	0.341	4.9	1.05	1.10	0.90	0.99
FNR6045S910MT	91±20%	0.467	0.359	4.9	1.00	1.10	0.85	0.94
FNR6045S101MT	100±20%	0.563	0.433	4.2	0.95	1.00	0.80	0.88
FNR6045S121MT	120±20%	0.629	0.484	4.2	0.85	0.94	0.77	0.85
FNR6045S151MT	150±20%	0.754	0.580	4.2	0.80	0.88	0.70	0.77
FNR6045S221MT	220±20%	1.084	0.834	3.5	0.70	0.77	0.59	0.65

Specifications subject to change without notice. Please check our website for latest informations.

SPECIFICATIONS

FNR6045S Series

Part Number	Inductance	DC Resistance		Self-resonant Frequency	Saturation Current*3		Heat Rating Current*4	
	@100kHz, 1V	Max.	Typ.	Min.	Max.	Typ.	Max.	Typ.
Units	μH	Ω		MHz	A		A	
Symbol	L	DCR		S.R.F	Isat		Irms	
FNR6045S331MT	330±20%	1.651	1.270	2.8	0.57	0.63	0.57	0.63
FNR6045S471MT	470±20%	2.340	1.800	2.0	0.50	0.56	0.42	0.48
FNR6045S681MT	680±20%	3.250	2.500	1.7	0.42	0.46	0.33	0.38
FNR6045S102MT	1000±20%	5.850	4.500	0.5	0.30	0.35	0.30	0.35
FNR6045S152MT	1500±20%	8.450	6.500	0.8	0.24	0.27	0.21	0.24
FNR6045S222KT	2200±10%	12.48	10.40	0.9	0.20	0.23	0.17	0.20
FNR6045S332KT	3300±10%	15.96	13.30	0.7	0.17	0.20	0.15	0.17
FNR6045S472KT	4700±10%	23.70	19.75	0.6	0.15	0.17	0.12	0.14
FNR6045S682KT	6800±10%	40.20	33.50	0.5	0.12	0.14	0.09	0.11
FNR6045S103KT	10000±10%	46.68	38.90	0.4	0.10	0.12	0.08	0.10
FNR6045S123KT	12000±10%	74.40	62.00	0.4	0.09	0.11	0.07	0.08
FNR6045S153KT	15000±10%	84.00	70.00	0.4	0.09	0.10	0.06	0.07

FNR8040S Series

Part Number	Inductance	DC Resistance		Self-resonant Frequency	Saturation Current*3		Heat Rating Current*4	
	@100kHz, 1V	Max.	Typ.	Min.	Max.	Typ.	Max.	Typ.
Units	μH	Ω		MHz	A		A	
Symbol	L	DCR		S.R.F	Isat		Irms	
FNR8040SR82NT	0.82±30%	0.010	0.008	94	13.80	16.00	6.30	6.90
FNR8040S1R0NT	1.0±30%	0.010	0.008	89	9.85	14.00	6.30	6.90
FNR8040S1R2NT	1.2±30%	0.013	0.010	59	10.00	14.00	5.65	6.20
FNR8040S1R5NT	1.5±30%	0.013	0.010	67	8.15	11.00	5.65	6.20
FNR8040S2R0NT	2.0±30%	0.016	0.012	43	9.25	10.00	5.15	5.60
FNR8040S2R2NT	2.2±30%	0.016	0.012	41	7.10	8.00	5.15	5.60
FNR8040S3R0NT	3.0±30%	0.018	0.014	32	6.10	7.00	4.70	5.20
FNR8040S3R3NT	3.3±30%	0.022	0.017	27	6.50	7.00	4.40	4.80
FNR8040S3R6NT	3.6±30%	0.022	0.017	30	7.52	8.50	4.35	4.80
FNR8040S3R9NT	3.9±30%	0.022	0.017	26	5.75	6.50	4.35	4.80
FNR8040S4R7NT	4.7±30%	0.025	0.019	24	5.90	6.50	4.10	4.50
FNR8040S5R1NT	5.1±30%	0.025	0.019	22	4.70	5.40	4.05	4.40
FNR8040S5R6NT	5.6±30%	0.027	0.021	24	6.00	6.90	3.85	4.20
FNR8040S6R2NT	6.2±30%	0.027	0.021	20	4.45	5.10	3.85	4.20
FNR8040S6R8MT	6.8±20%	0.031	0.024	20	4.55	5.20	3.60	4.00
FNR8040S8R2MT	8.2±20%	0.034	0.026	17	4.20	4.80	3.45	3.80
FNR8040S100MT	10±20%	0.038	0.029	15	3.60	4.10	3.30	3.60
FNR8040S120MT	12±20%	0.053	0.041	13	3.50	4.00	2.80	3.00
FNR8040S150MT	15±20%	0.061	0.047	12	2.95	3.40	2.60	2.80
FNR8040S180MT	18±20%	0.069	0.053	11	2.70	3.10	2.40	2.60
FNR8040S220MT	22±20%	0.090	0.069	9.5	2.40	2.70	2.10	2.30
FNR8040S270MT	27±20%	0.101	0.078	9.2	2.15	2.50	2.00	2.20
FNR8040S330MT	33±20%	0.126	0.097	7.8	2.05	2.40	1.80	2.00
FNR8040S360MT	36±20%	0.133	0.102	7.8	2.00	2.30	1.75	1.90
FNR8040S390MT	39±20%	0.139	0.107	7.8	1.95	2.20	1.70	1.90
FNR8040S430MT	43±20%	0.147	0.113	7.8	1.90	2.20	1.65	1.80
FNR8040S470MT	47±20%	0.177	0.136	6.4	1.75	2.00	1.55	1.70
FNR8040S510MT	51±20%	0.185	0.142	6.4	1.70	1.90	1.50	1.60

SPECIFICATIONS

FNR8040S Series

Part Number	Inductance	DC Resistance		Self-resonant Frequency	Saturation Current*3		Heat Rating Current*4	
	@100kHz,1V	Max.	Typ.	Min.	Max.	Typ.	Max.	Typ.
Units	μH	Ω		MHz	A		A	
Symbol	L	DCR		S.R.F	Isat		Irms	
FNR8040S620MT	62±20%	0.237	0.182	6.4	1.50	1.60	1.30	1.40
FNR8040S680MT	68±20%	0.255	0.196	4.9	1.45	1.60	1.25	1.40
FNR8040S750MT	75±20%	0.274	0.211	4.9	1.35	1.50	1.20	1.30
FNR8040S820MT	82±20%	0.293	0.225	5.9	1.30	1.40	1.15	1.20
FNR8040S910MT	91±20%	0.354	0.272	4.9	1.20	1.30	1.05	1.10
FNR8040S101MT	100±20%	0.377	0.290	4.2	1.15	1.30	1.00	1.10
FNR8040S121MT	120±20%	0.434	0.334	3.5	1.05	1.10	0.95	1.00
FNR8040S151MT	150±20%	0.533	0.410	3.5	1.10	1.20	0.85	0.94
FNR8040S181MT	180±20%	0.676	0.520	3.5	0.95	1.15	0.83	0.92
FNR8040S221MT	220±20%	0.779	0.599	3.5	0.85	0.94	0.80	0.88
FNR8040S331MT	330±20%	1.156	0.889	2.8	0.68	0.75	0.64	0.70
FNR8040S471MT	470±20%	1.625	1.260	2.1	0.60	0.70	0.50	0.60
FNR8040S681MT	680±20%	2.652	2.040	1.7	0.50	0.60	0.45	0.50
FNR8040S102MT	1000±20%	3.640	2.800	1.4	0.40	0.50	0.35	0.40
FNR8040S152MT	1500±20%	6.500	5.000	1.0	0.32	0.38	0.26	0.27

FNR8050S Series

Part Number	Inductance	DC Resistance		Self-resonant Frequency	Saturation Current*3		Heat Rating Current*4	
	@100kHz,1V	Max.	Typ.	Min.	Max.	Typ.	Max.	Typ.
Units	μH	Ω		MHz	A		A	
Symbol	L	DCR		S.R.F	Isat		Irms	
FNR8050S102MT	1000±20%	2.52	2.10	1.5	0.32	0.35	0.33	0.35
FNR8050S103MT*	10000±20%	22.80	19.00	0.35	0.09	0.10	0.11	0.13

*The test frequency of FNR8050S103MT is 1KHz.

FNR8065S Series

Part Number	Inductance	DC Resistance		Self-resonant Frequency	Saturation Current*3		Heat Rating Current*4	
	@100kHz,1V	Max.	Typ.	Min.	Max.	Typ.	Max.	Typ.
Units	μH	Ω		MHz	A		A	
Symbol	L	DCR		S.R.F	Isat		Irms	
FNR8065S1R0MT	1.0±20%	0.011	0.008	96	20.0	22.0	7.00	8.00
FNR8065S3R3MT	3.3±20%	0.018	0.015	27	9.50	10.00	5.10	5.90
FNR8065S4R7MT	4.7±20%	0.022	0.018	18	8.50	9.50	4.70	5.40
FNR8065S5R6MT	5.6±20%	0.026	0.022	17	8.00	9.00	4.50	5.20
FNR8065S6R8MT	6.8±20%	0.026	0.022	16	7.50	8.00	4.50	5.20
FNR8065S8R2MT	8.2±20%	0.031	0.026	15	7.00	7.70	4.20	4.80
FNR8065S100MT	10±20%	0.044	0.037	13	8.00	8.90	3.20	3.70
FNR8065S220MT	22±20%	0.065	0.054	8	4.30	4.80	2.85	3.30
FNR8065S431MT	430±20%	1.200	1.000	1.5	0.95	1.05	0.61	0.69
FNR8065S102MT	1000±20%	2.820	2.350	1.1	0.65	0.73	0.40	0.45
FNR8065S152MT	1500±20%	4.380	3.650	0.7	0.54	0.60	0.32	0.37
FNR8065S222MT	2200±20%	6.000	5.000	0.7	0.45	0.51	0.27	0.31
FNR8065S332MT	3300±20%	8.760	7.300	0.7	0.36	0.40	0.23	0.26

SPECIFICATIONS

FNR8065S Series

Part Number	Inductance	DC Resistance		Self-resonant Frequency	Saturation Current*3		Heat Rating Current*4	
	@100kHz, 1V	Max.	Typ.	Min.	Max.	Typ.	Max.	Typ.
Units	μH	Ω		MHz	A		A	
Symbol	L	DCR		S.R.F	Isat		Irms	
FNR8065S472MT	4700 \pm 20%	14.58	12.15	0.4	0.29	0.33	0.18	0.20
FNR8065S682MT	6800 \pm 20%	22.44	18.70	0.4	0.26	0.29	0.14	0.16
FNR8065S103MT	10000 \pm 20%	27.36	22.80	0.4	0.20	0.23	0.13	0.15

※1: All test data is referenced to 20°C ambient;

※2: Rated current: Isat or Irms, whichever is smaller;

※*3: Isat: DC current at which the inductance drops approximate 30% from its value without current;

※*4: Irms: DC current that causes the temperature rise ($\Delta T = 40^\circ\text{C}$) from 20°C ambient.

TYPICAL ELECTRICAL CHARACTERISTICS

FNR252010S Series

Temperature vs. DC Current Characteristics



Inductance vs. DC Current Characteristics



FNR252012S Series

Temperature vs. DC Current Characteristics



Inductance vs. DC Current Characteristics



X-ON Electronics

Largest Supplier of Electrical and Electronic Components

Click to view similar products for [Fixed Inductors](#) category:

Click to view products by [Changjiang Microelectronics](#) manufacturer:

Other Similar products are found below :

[CR32NP-100KC](#) [CR32NP-151KC](#) [CR32NP-180KC](#) [CR32NP-181KC](#) [CR32NP-1R5MC](#) [CR32NP-390KC](#) [CR32NP-3R9MC](#) [CR32NP-680KC](#) [CR32NP-820KC](#) [CR32NP-8R2MC](#) [CR43NP-390KC](#) [CR43NP-560KC](#) [CR43NP-680KC](#) [CR54NP-181KC](#) [CR54NP-470LC](#) [CR54NP-820KC](#) [CR54NP-8R5MC](#) [70F224AI](#) [MGDQ4-00004-P](#) [MHL1ECTTP18NJ](#) [MHQ1005P10NJ](#) [MHQ1005P1N0S](#) [MHQ1005P2N4S](#) [MHQ1005P3N6S](#) [MHQ1005P5N1S](#) [MHQ1005P8N2J](#) [PE-51506NL](#) [PE-53601NL](#) [PE-53602NL](#) [PE-53630NL](#) [PE-53824SNLT](#) [PE-92100NL](#) [PG0434.801NLT](#) [PG0936.113NLT](#) [9220-20](#) [9310-16](#) [PM06-2N7](#) [PM06-39NJ](#) [A01TK](#) [1206CS-471XJ](#) [HC2LP-R47-R](#) [HC2-R47-R](#) [HC3-2R2-R](#) [HCF1305-3R3-R](#) [1206CS-151XG](#) [RCH664NP-140L](#) [RCH664NP-4R7M](#) [RCH8011NP-221L](#) [RCP1317NP-332L](#) [RCP1317NP-391L](#)