

Wire Wound SMD Power Inductors – FNRH Series

Operating Temp. : -40°C~+125°C
(including Self-heating)



FEATURES

- Magnetic-resin shielded construction reduces buzz noise to ultra-low levels
- Metallization on ferrite core results in excellent shock resistance and damage-free durability
- Closed magnetic circuit design reduces leakage flux and Electro Magnetic Interference (EMI)
- Takes up less PCB real estate and save more power
- 30% lower DCR than FNR series and larger current

特征

- 磁性膠水塗敷結構極大減少了蜂鳴聲
- 在磁芯上金屬化電極，抗跌落沖擊強，經久耐用
- 閉合磁路結構設計，漏磁少，抗 EMI 能力強
- 省空間，更省電
- 較FNR系列直流電阻降低30%左右，具有更大電流

APPLICATIONS

- Smart phone
- Blue -ray disc recorders, set top box
- Notebooks, desktop computers, servers
- Portable gaming devices, personal navigation systems, personal multimedia devices
- SSD, Bluetooth, Wi-Fi module
- NB-IOT, Bluetooth headset, Smart speakers

用途

- 智能手機
- 機頂盒藍光光盤錄像機
- 筆記本電腦、臺式電腦、服務器
- 便攜式遊戲設備、個人導航系統、個人多媒體設備
- 固態硬盤、藍牙、WIFI 模塊
- 物聯網模塊、藍牙耳機、智能音箱

PRODUCT IDENTIFICATION

FNRH 201610 S - 2R2 M T

① ② ③ ④ ⑤ ⑥

① Type	
FNRH	Wire Wound SMD Power Inductor

③ Material Code	
S	S Type

⑤ Inductance Tolerance	
M	±20%
N	±30%

⑥ Packing	
T	Tape & Reel

② External Dimensions (L×W×H) [mm]	
201610	2.0×1.6×1.0
252010	2.5×2.0×1.0
252012	2.5×2.0×1.2

④ Nominal Inductance	
Example	Nominal Value
1R0	1.0μH
2R2	2.2μH
100	10μH

SHAPE AND DIMENSIONS

Fig.1

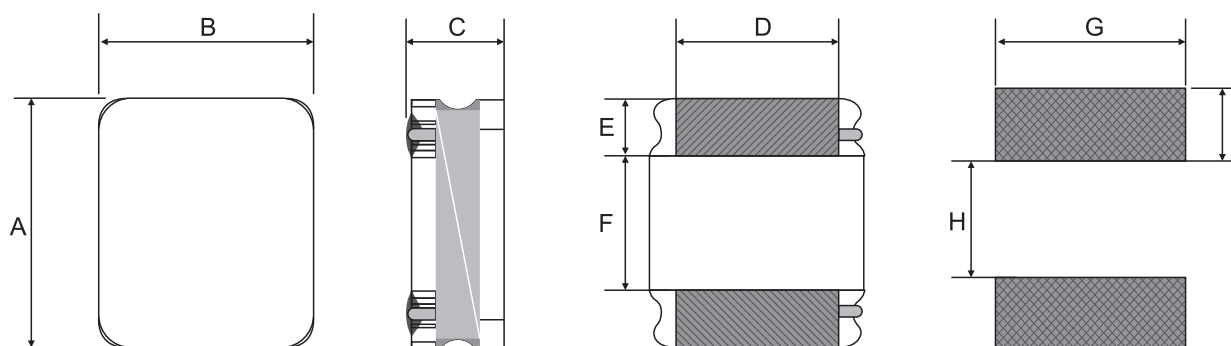

Unit: mm

Series	Shape	A	B	C	D	E	F	H Typ.	I Typ.	G Typ.
FNRH201610	Fig.1	2.0±0.2	1.6±0.2	1.05 Max.	1.2±0.2	0.60±0.2	0.80±0.2	0.70	0.70	1.7
FNRH252010	Fig.1	2.5±0.1	2.0±0.1	1.05 Max.	1.5±0.2	0.80±0.2	0.80±0.2	0.80	0.85	2.0
FNRH252012	Fig.1	2.5±0.1	2.0±0.1	1.2 Max.	1.5±0.2	0.80±0.2	0.80±0.2	0.80	0.85	2.0

SPECIFICATIONS

FNRH201610S Series

Part Number	Inductance	DC Resistance		Saturation Current		Heat Rating Current	
	1MHz/1V	Max.	Typ.	Max.	Typ.	Max.	Typ.
Units	μH	Ω	Ω	A	A	A	A
Symbol	L	DCR		Isat		Irms	
FNRH201610S-R24MT	0.24±20%	40	33	3.70	4.10	2.80	3.10
FNRH201610S-R33MT	0.33±20%	48	41	3.00	3.70	2.40	2.90
FNRH201610S-R47MT	0.47±20%	60	50	2.30	2.85	2.30	2.60
FNRH201610S-R68MT	0.68±20%	76	63	1.95	2.45	2.00	2.20
FNRH201610S-1R0MT	1.0±20%	114	96	1.65	1.85	1.45	1.60
FNRH201610S-1R5MT	1.5±20%	174	145	1.35	1.65	1.10	1.20
FNRH201610S-2R2MT	2.2±20%	265	215	1.20	1.45	1.05	1.15
FNRH201610S-3R3MT	3.3±20%	345	290	1.00	1.20	0.85	0.95
FNRH201610S-4R7MT	4.7±20%	480	400	0.75	0.90	0.70	0.80
FNRH201610S-6R8MT	6.8±20%	800	610	0.70	0.85	0.55	0.60
FNRH201610S-8R2MT	8.2±20%	940	730	0.68	0.78	0.53	0.60
FNRH201610S-100MT	10±20%	1000	800	0.65	0.70	0.50	0.60
FNRH201610S-120MT	12±20%	1430	1100	0.62	0.70	0.36	0.42
FNRH201610S-220MT	22±20%	1700	1400	0.32	0.38	0.32	0.36

FNRH252010S Series

Part Number	Inductance	DC Resistance		Saturation Current		Heat Rating Current	
	1MHz/1V	Max.	Typ.	Max.	Typ.	Max.	Typ.
Units	μH	Ω	Ω	A	A	A	A
Symbol	L	DCR		Isat		Irms	
FNRH252010S-R24MT	0.24±20%	0.034	0.026	3.60	4.40	2.75	3.00
FNRH252010S-R33MT	0.33±20%	0.043	0.033	3.60	4.30	2.45	2.70
FNRH252010S-R47MT	0.47±20%	0.044	0.033	2.80	3.20	2.40	2.60
FNRH252010S-R68MT	0.68±20%	0.062	0.051	2.75	3.10	2.10	2.35
FNRH252010S-1R0MT	1.0±20%	0.080	0.066	2.05	2.50	1.85	2.05
FNRH252010S-1R5MT	1.5±20%	0.108	0.085	1.70	2.05	1.55	1.70
FNRH252010S-2R2MT	2.2±20%	0.150	0.130	1.50	1.75	1.35	1.50
FNRH252010S-3R3MT	3.3±20%	0.228	0.170	1.10	1.35	1.05	1.20
FNRH252010S-4R7MT	4.7±20%	0.330	0.280	1.00	1.15	0.90	1.00
FNRH252010S-5R6MT	5.6±20%	0.480	0.370	0.90	1.05	0.80	0.90
FNRH252010S-6R8MT	6.8±20%	0.480	0.400	0.80	0.95	0.72	0.80
FNRH252010S-8R2MT	8.2±20%	0.572	0.463	0.73	0.85	0.69	0.78
FNRH252010S-100MT	10±20%	0.600	0.500	0.65	0.75	0.67	0.74
FNRH252010S-150MT	15±20%	0.950	0.780	0.50	0.60	0.45	0.50

SPECIFICATIONS

FNRH252012S Series

Part Number	Inductance	DC Resistance		Saturation Current		Heat Rating Current	
	1MHz/1V	Max.	Typ.	Max.	Typ.	Max.	Typ.
Units	μH	Ω	Ω	A	A	A	A
Symbol	L	DCR		Isat		Irms	
FNRH252012S-R24MT	0.24±20%	0.023	0.019	4.10	4.80	4.10	4.50
FNRH252012S-R33MT	0.33±20%	0.031	0.026	4.00	4.70	3.35	3.70
FNRH252012S-R47MT	0.47±20%	0.036	0.031	3.80	4.50	3.00	3.30
FNRH252012S-R68MT	0.68±20%	0.047	0.038	3.00	3.30	2.30	2.50
FNRH252012S-1R0MT	1.0±20%	0.060	0.050	2.25	2.50	2.30	2.60
FNRH252012S-1R2MT	1.2±20%	0.078	0.065	2.20	2.50	2.00	2.20
FNRH252012S-1R5MT	1.5±20%	0.090	0.075	2.00	2.35	1.80	2.00
FNRH252012S-1R8MT	1.8±20%	0.108	0.093	1.95	2.20	1.75	1.90
FNRH252012S-2R2MT	2.2±20%	0.108	0.093	1.75	1.90	1.75	1.90
FNRH252012S-2R7MT	2.7±20%	0.156	0.130	1.30	1.60	1.40	1.50
FNRH252012S-3R3MT	3.3±20%	0.156	0.130	1.20	1.35	1.40	1.50
FNRH252012S-4R7MT	4.7±20%	0.228	0.190	1.10	1.20	1.10	1.20
FNRH252012S-5R6MT	5.6±20%	0.330	0.255	1.00	1.10	1.00	1.15
FNRH252012S-6R8MT	6.8±20%	0.360	0.300	0.90	1.10	0.95	1.05
FNRH252012S-100MT	10±20%	0.522	0.435	0.70	0.85	0.78	0.86
FNRH252012S-150MT	15±20%	1.000	0.700	0.60	0.70	0.50	0.60
FNRH252012S-220MT	22±20%	1.290	1.000	0.45	0.55	0.48	0.55

Note:※1: Rated current: Isat(max.)or Irms(max.),whichever is smaller;

※2: Isat:Max. Value, DC current at which the inductance drops less than 30% from its value without current; Typ. Value, DC current at which the inductance drops 30% from its value without current;

※3: Irms: DC current that causes the temperature rise (ΔT) from 20°C ambient.

For Max. Value, $\Delta T < 40^\circ\text{C}$; for Typ. Value, ΔT is approximate 40°C.

The part temperature (ambient + temp. rise) should not exceed 125°C under worst case operating conditions.

Circuit design, component placement, PCB trace size and thickness, airflow and other cooling provisions all affect the part temperature. Part temperature should be verified in the end application.

STRUCTURE

The structure of FNRH product.

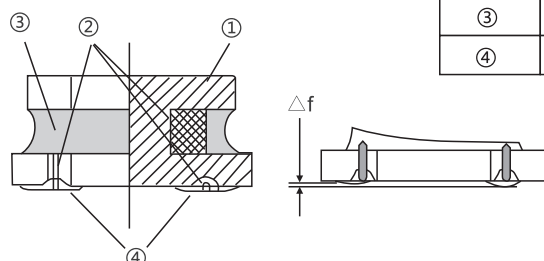

NO.	Components	Material
①	Core	Ni-Zn Ferrite
②	Wire	Polyurethane system enameled copper wire
③	Magnetic Glue	Epoxy resin and magnetic powder
④	Electrodes	AgNiSn or FeNiCu + Sn Alloy

Δf : Clearance between terminal and the surface of plate must be 0.1mm max when coil is placed on a flat plate.

TYPICAL ELECTRICAL CHARACTERISTICS

FNRH201610S Series

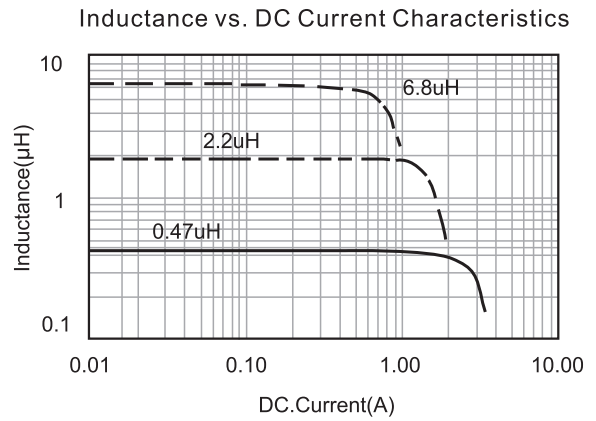
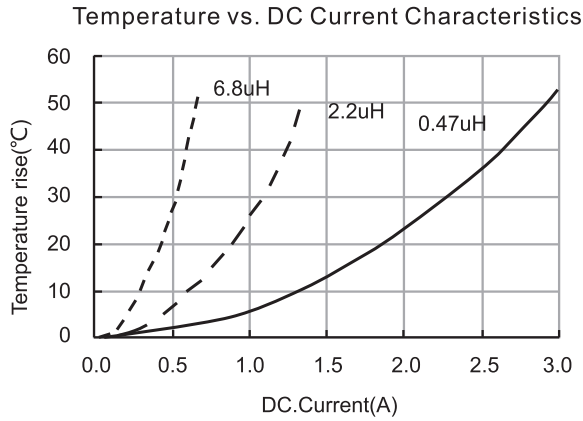

FNRH252010S Series

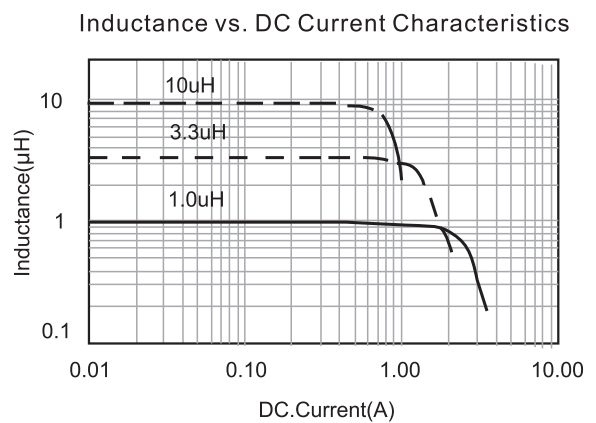
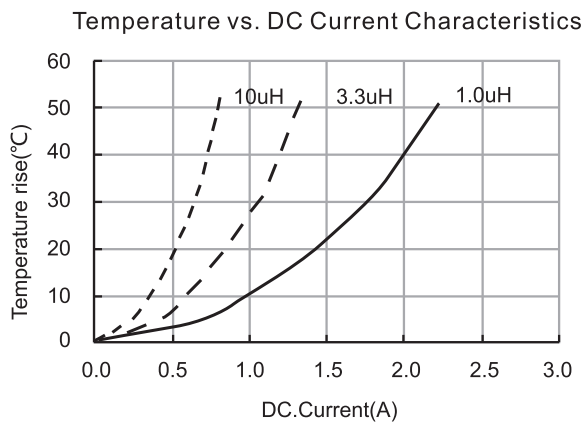

FNRH252012S Series

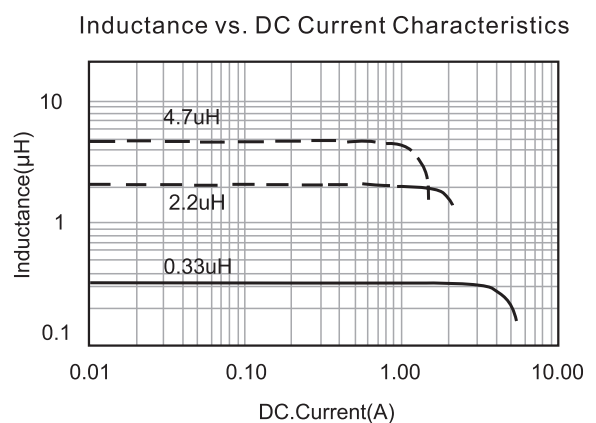
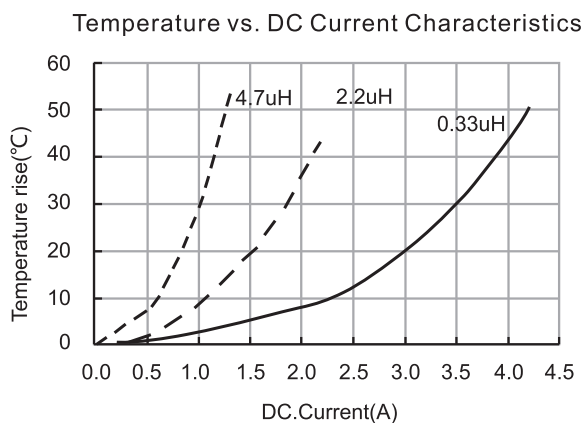

X-ON Electronics

Largest Supplier of Electrical and Electronic Components

Click to view similar products for [Fixed Inductors](#) category:

Click to view products by [Changjiang Microelectronics](#) manufacturer:

Other Similar products are found below :

[MLZ1608M6R8WTD25](#) [MLZ1608N6R8LT000](#) [MLZ1608N3R3LTD25](#) [MLZ1608N3R3LT000](#) [MLZ1608N150LT000](#)
[MLZ1608M150WTD25](#) [MLZ1608M3R3WTD25](#) [MLZ1608M3R3WT000](#) [MLZ1608M150WT000](#) [MLZ1608A1R5WT000](#)
[MLZ1608N1R5LT000](#) [B82432C1333K000](#) [PCMB053T-1R0MS](#) [PCMB053T-1R5MS](#) [PCMB104T-1R5MS](#) [CR32NP-100KC](#) [CR32NP-151KC](#) [CR32NP-180KC](#) [CR32NP-181KC](#) [CR32NP-1R5MC](#) [CR32NP-390KC](#) [CR32NP-3R9MC](#) [CR32NP-680KC](#) [CR32NP-820KC](#)
[CR32NP-8R2MC](#) [CR43NP-390KC](#) [CR43NP-560KC](#) [CR43NP-680KC](#) [CR54NP-181KC](#) [CR54NP-470LC](#) [CR54NP-820KC](#) [CR54NP-8R5MC](#)
[ET3542-057](#) [MGDQ4-00004-P](#) [MGDU1-00016-P](#) [MHL1ECTTP18NJ](#) [MHL1JCTTD12NJ](#) [PE-51506NL](#) [PE-53601NL](#) [PE-53630NL](#) [PE-53824SNLT](#) [PE-62892NL](#) [PE-92100NL](#) [PG0434.801NLT](#) [PG0936.113NLT](#) [PM06-2N7](#) [PM06-39NJ](#) [HC2LP-R47-R](#) [HC2-R47-R](#) [HC3-2R2-R](#)