

# Specification of Cjiang products

Customer	
Product Name	Wire Wound Molded SMD Power Inductors
Customer P/N:	
Cjiang P/N:	FPA322520D Series

[  New Released,  Revised]

SPEC No:

REMARK:		
Customer Approval Feedback		

●深圳市长江微电科技有限公司

SZ CJIANG TECHNOLOGY CO.,LTD

ADD: 11F, International Science and Technology Building, Fuhong Road, Futian District, Shenzhen

Factory ADD:No. shanyang RD CJIANG Industrial Park HUAI'AN Section HUAI'AN City Jiangsu Province

TEL: 0755-82529562 FAX:0755-83977004

<http://www.CJIANG.COM.CN>

SALES: E-mail: [BOND@Cjiang.com.cn](mailto:BOND@Cjiang.com.cn); [ann@cjiang.com.cn](mailto:ann@cjiang.com.cn)

R&D: E-mail: [LZJ@cjiang.com.cn](mailto:LZJ@cjiang.com.cn)

### Version change history

Rev	Date	Description	APPROVED	CHECKED	DRAWN
1.0	2024/6/28	Document formulation	BOND	Charles	Roy

#### Caution :

All products listed in this specification are developed, designed and intended for use in general electronics equipment. The products are not designed or Warranted to meet the requirements of the applications listed below, whose performance and/or quality require especially high reliability, or whose failure, malfunction or trouble might directly cause damage to society, person, or property. Please understand that we are not responsible for any damage or liability caused by use of the products in any of the applications below. Please contact us for more details if you intend to use our products in the following applications.

1. Aircraft equipment.
2. Aerospace equipment.
3. Undersea equipment.
4. nuclear control equipment.
5. military equipment.
6. Power plant equipment.
7. Medical equipment.
8. Traffic signal equipment.
9. Disaster prevention / crime prevention equipment.
10. Data-processing equipment.
11. Applications of similar complexity or with reliability requirements comparable to the applications listed in the above.
12. This series of products of our company apply to regular use in general automotive electronics and in-car electronics.

Not applicable to components related to driving safety of automobiles.

The company does not guarantee the applicability or performance of this series related to equipment failures during the operation of automobiles — including but not limited to brake failure, driving failure, poor operation, and other failures that may cause damage to the lives, bodies, or property of human, as well as applications that may have significant social impact (hereinafter referred to as "specific uses").

# Power Inductor FPA322520D

## 1. Features

- High magnetic flux saturation density characteristics by metal magnetic material.
- Low DC resistance by flat wire.and achieve high conversion efficiency and lower temperature rising.
- Magnetically shielded structure to accomplish high resolution in EMC protection.
- High mounting stability due to Chip shape.
- High reliability by original structure.
- Halogen free,Lead free. RoHS Compliance.
- Compliant with AEC-Q200

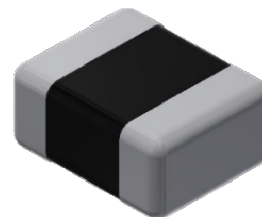

## 2. Application

- DC/DC converter.
- Smart phone, PAD, HDD, SSD, DVC, DSC.
- Mobile display panels, Portable game devices, Compact power supply modules,other.
- Automotive infotainment/comfort equipment

## 3. Part Number Construction

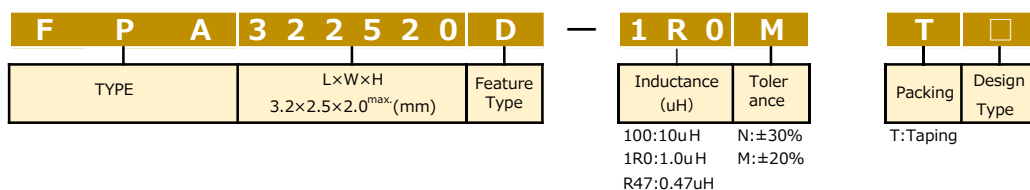

## 4.Characteristics Specification Table

Part No.	L (uH)	Tolerance	Rdc (mΩ) Max.[Typ.]	I <sub>sat</sub> (A) Max.[Typ.]	I <sub>temp</sub> (A) Max.[Typ.]
FPA322520D-1R0MT0	<b>1.00</b>	±20%	<b>22 [18]</b>	<b>7.5 [8.2]</b>	<b>4.1 [4.8]</b>
FPA322520D-1R5MT0	<b>1.50</b>	±20%	<b>31 [25]</b>	<b>6.0 [6.5]</b>	<b>3.4 [4.0]</b>
FPA322520D-2R2MT0	<b>2.20</b>	±20%	<b>46 [37]</b>	<b>5.0 [5.4]</b>	<b>2.9 [3.4]</b>
FPA322520D-3R3MT0	<b>3.30</b>	±20%	<b>65 [52]</b>	<b>4.2 [4.5]</b>	<b>2.3 [2.7]</b>
FPA322520D-4R7MT0	<b>4.70</b>	±20%	<b>98 [80]</b>	<b>3.4 [3.6]</b>	<b>2.0 [2.4]</b>

- Test frequency at 1MHz,OSC Level:0.5V
- Inductance is measured with Keysight Technologies LCR meter 4285A. Equivalent measurement equipment may be used.
- Rated current: smaller value of either Isat or Itemp.
- Isat:The DC current at which the inductance decreases approximately 30% from the actual initial value.
- Itemp:The DC current at which the temperature rises approximately ΔT=40°C.
  - ※ Itemp is a reference value according to our usage environment.
  - ※ In the end application, the circuit design should be such that the part temperature rise does not exceed 40 °C.
- Withstand DC Voltage : 20[V].

# Power Inductor FPA322520D

## 5.L Frequency Characteristics

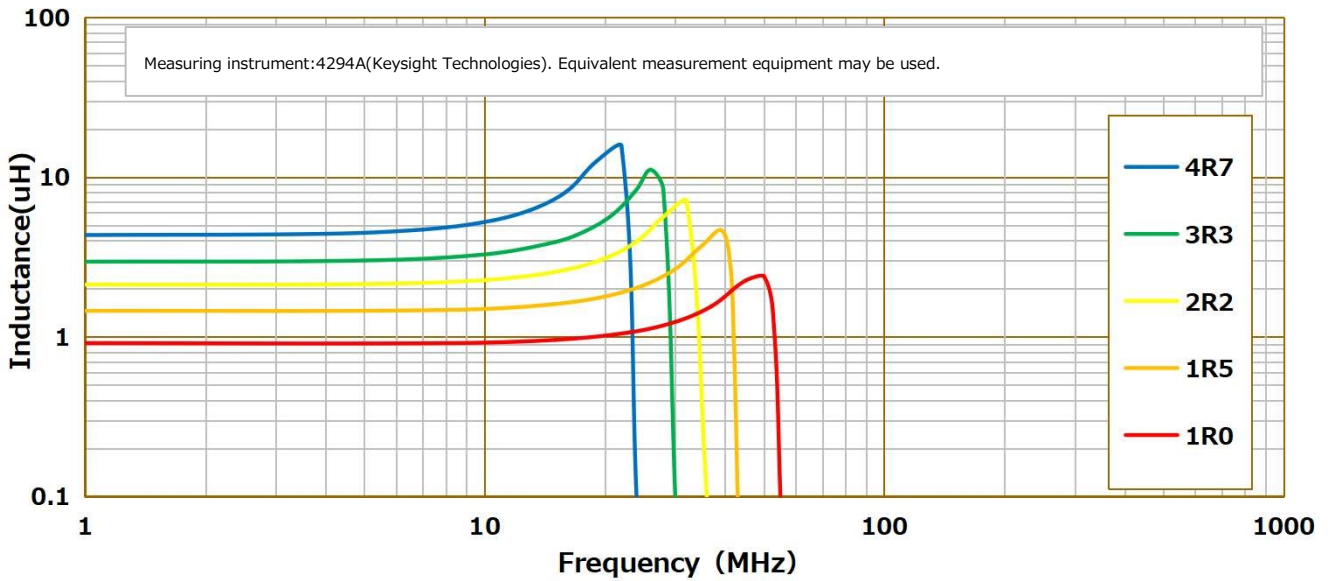

## 6. Inductance vs. DC Bias Characteristics

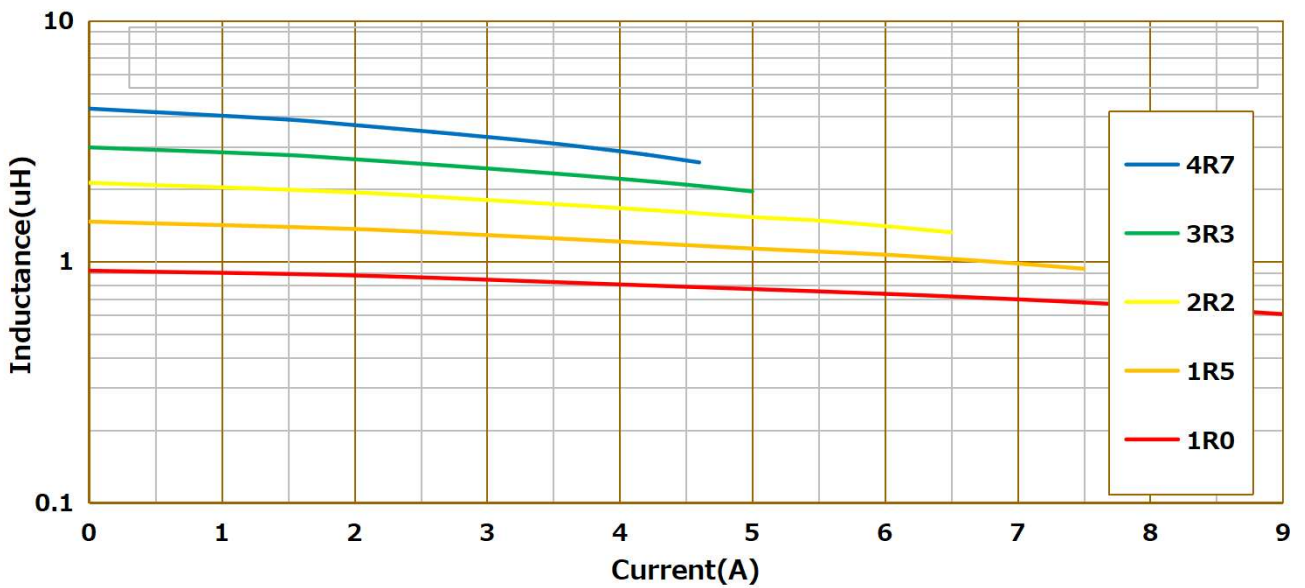

## 7. Shape & Dimensions

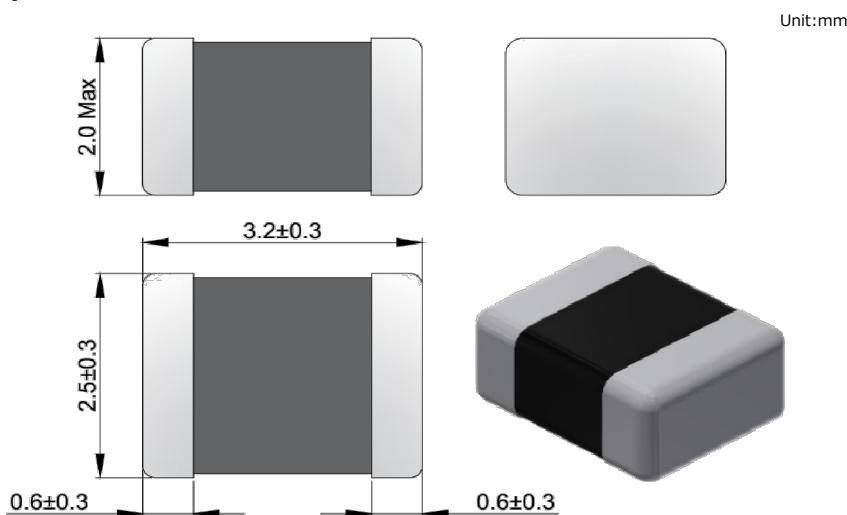

# Power Inductor FPA322520D

## 8. Packaging Style

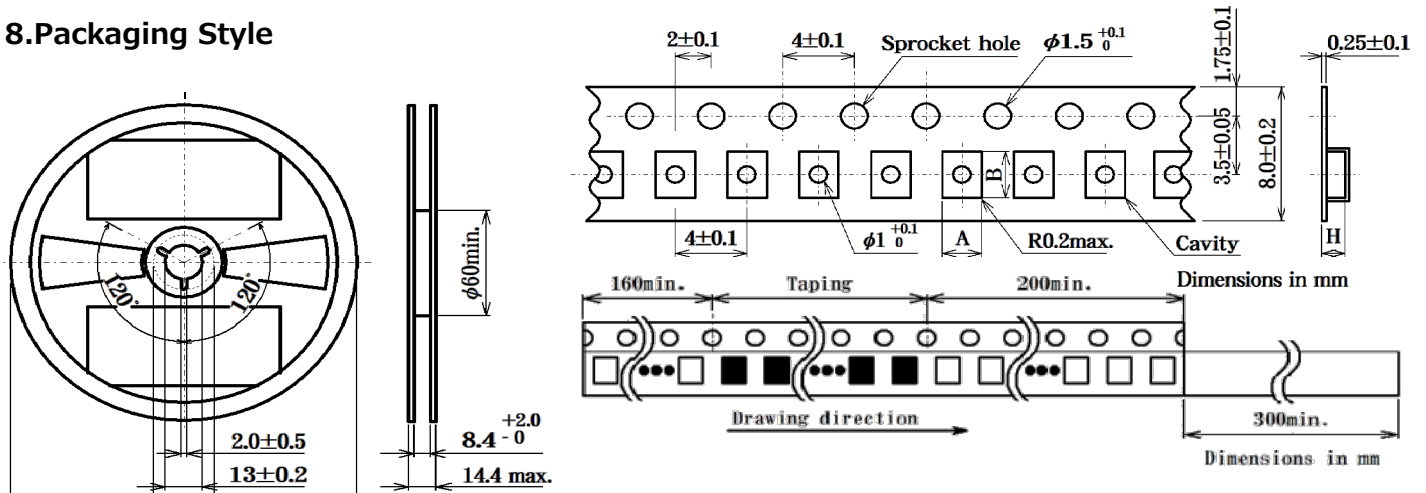

Dimensions in mm

Series	A	B	H	(pcs/reel)	(g/reel)
FPA322520D--□□□MT□	2.85±0.1	3.5±0.1	2.4±0.1	2,000	250±10

※A & B MEASUREMENT POINT TO BE 0.20mm FROM BOTTOM POCKET.

Packing Box

Box Name	Size(cm)	Weight(g)
80K Inner Packing Box	39*29*21.5	433±20
80K Outer Packing Box	41*31*24.5	503±20
40K Inner Packing Box	29*20*21.5	229±20
40K Outer Packing Box	31*22*24.5	299±20
10K Packing Box	19.8*18.8*7	76±20

## 9. Recommended Land Pattern

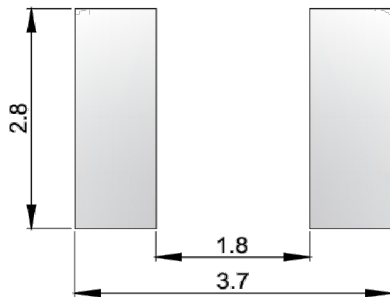

Unit:mm

## 10. Recommended Reflow Profile

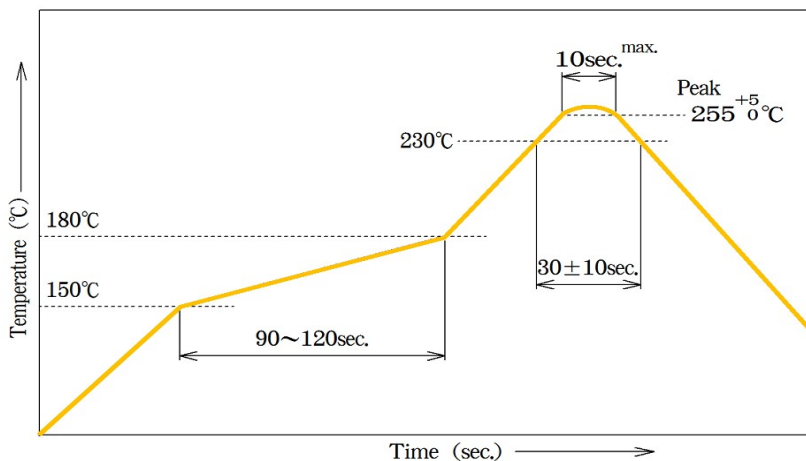

# Power Inductor FPA322520D

## 11. Reliability and Test Condition

Test item	Test condition	Specification															
Dry heat Test  AEC-Q200(Rev.E) Test No.3	<ul style="list-style-type: none"> <li>Temperature: +125±2℃</li> <li>Load time: 1000±12Hr</li> <li>Measurement shall be made within 24±4 h.</li> </ul>	<ul style="list-style-type: none"> <li>ΔL/L : within ± 10%(Change from an initial value)</li> <li>No abnormal appearance after the test.</li> </ul>															
Temperature cycle Test  AEC-Q200(Rev.E) Test No.4	<ul style="list-style-type: none"> <li>Condition of 1 cycle</li> </ul> <table border="1"> <thead> <tr> <th>Step</th> <th>Temp.</th> <th>Duration</th> </tr> </thead> <tbody> <tr> <td>1</td> <td>-40±3</td> <td>30±3</td> </tr> <tr> <td>2</td> <td>Room temp.</td> <td>Within 2</td> </tr> <tr> <td>3</td> <td>+125±2</td> <td>30±3</td> </tr> <tr> <td>4</td> <td>Room temp.</td> <td>Within 2</td> </tr> </tbody> </table> <ul style="list-style-type: none"> <li>Load cycle : 1000±12cycle</li> <li>Measurement shall be made within 24±4 h.</li> </ul>	Step	Temp.	Duration	1	-40±3	30±3	2	Room temp.	Within 2	3	+125±2	30±3	4	Room temp.	Within 2	<ul style="list-style-type: none"> <li>ΔL/L : within ± 10%(Change from an initial value)</li> <li>No abnormal appearance after the test.</li> </ul>
Step	Temp.	Duration															
1	-40±3	30±3															
2	Room temp.	Within 2															
3	+125±2	30±3															
4	Room temp.	Within 2															
Humidity Test  AEC-Q200(Rev.E) Test No.7	<ul style="list-style-type: none"> <li>Temperature: +85±2℃</li> <li>Humidity: 85%RH</li> <li>Load time: 1000±12Hr</li> <li>Measurement shall be made within 24±4 h.</li> </ul>	<ul style="list-style-type: none"> <li>ΔL/L : within ± 10%(Change from an initial value)</li> <li>No abnormal appearance after the test.</li> </ul>															
High Temperature Operating Test  AEC-Q200(Rev.E) Test No.8	<ul style="list-style-type: none"> <li>Temperature: +85±2℃</li> <li>Rated current: smaller value of either Isat or Itemp.</li> <li>Load time: 1000±12Hr</li> <li>Measurement shall be made within 24±4 h.</li> </ul>	<ul style="list-style-type: none"> <li>ΔL/L : within ± 10%(Change from an initial value)</li> <li>No abnormal appearance after the test.</li> </ul>															
Physical Dimensions AEC-Q200(Rev.E) Test No.10	<ul style="list-style-type: none"> <li>Measures using digital slide calipers and an optical microscope.</li> </ul>	<ul style="list-style-type: none"> <li>According to specification</li> </ul>															
Resistance to Solvent  AEC-Q200(Rev.E) Test No.12	<ul style="list-style-type: none"> <li>Immerse in Isopropyl-Alcohol for 5 minutes at 25±5℃. Measurement shall be made within 1h</li> </ul>	<ul style="list-style-type: none"> <li>ΔL/L : within ± 10%(Change from an initial value)</li> <li>No abnormal appearance after the test.</li> </ul>															
Mechanical shock test  AEC-Q200(Rev.E) Test No.13	<ul style="list-style-type: none"> <li>Peak acceleration: 981 m/s<sup>2</sup> (≈100G)</li> <li>Duration of pulse : 6ms</li> <li>3 times in each of 3(±X, ±Y, ±Z) axes.</li> </ul>	<ul style="list-style-type: none"> <li>ΔL/L : within ± 10%(Change from an initial value)</li> <li>No abnormal appearance after the test.</li> </ul>															
Vibration test  AEC-Q200(Rev.E) Test No.14	<ul style="list-style-type: none"> <li>Sweep frequency : 10~2000Hz(10Hz to 1000Hz to 10Hz in a period of one minute)</li> <li>Amplitud : 1.5mm</li> <li>4Hr in each of 3(X, Y, Z) axes.</li> </ul>	<ul style="list-style-type: none"> <li>ΔL/L : within ± 10%(Change from an initial value)</li> <li>No abnormal appearance after the test.</li> </ul>															

# Power Inductor FPA322520D

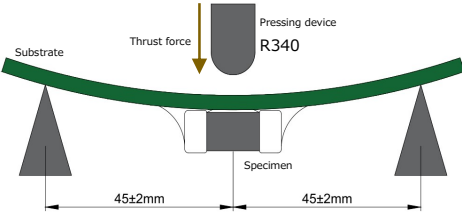
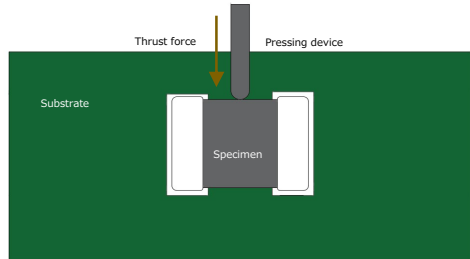
Test item	Test condition	Specification
Resistance to Soldering Heat  <b>AEC-Q200(Rev.E) Test No.15</b>	<ul style="list-style-type: none"> <li>Reflow soldering method</li> <li>Preheat : above 183°C 90~120sec.</li> <li>Peak temperature. : 250(±5)°C 30±5sec.</li> <li>PCB thickness:0.8mm</li> <li>3times</li> <li>The specimen shall be stored at standard atmospheric conditions for 1 h in prior to the measurement.</li> </ul>	<ul style="list-style-type: none"> <li>ΔL/L : within ± 10%(Change from an initial value)</li> <li>No abnormal appearance after the test.</li> </ul>
ESD  <b>AEC-Q200(Rev.E) Test No.17</b>	<ul style="list-style-type: none"> <li>3 times in each of terminals and top side of component.</li> <li>Direct contact discharge : ±0.5kV</li> </ul>	<ul style="list-style-type: none"> <li>ΔL/L : within ± 10%(Change from an initial value)</li> <li>No abnormal appearance after the test.</li> </ul>
Solderability  <b>AEC-Q200(Rev.E) Test No.18</b>	<ul style="list-style-type: none"> <li>Electrode shall be immersed in flux at room temperature and then shall be immersed in solder bath after preheat</li> <li>Solder temperature:245±5°C</li> <li>Dip time:5±0.5sec.</li> </ul>	<ul style="list-style-type: none"> <li>New solder shall cover 90% minimum of the surface immersed.</li> </ul>
Electrical Characterizatic  <b>AEC-Q200(Rev.E) Test No.19</b>	<ul style="list-style-type: none"> <li>To be measured in the range of -40°C to 125°C.</li> <li>Parametrically test per lot and sample size requirements, summary to show Min, Max, Mean and Standard deviation at roomas well as Min and Max operating temperatures.</li> </ul>	<ul style="list-style-type: none"> <li>According to specification</li> </ul>
Bending test  <b>AEC-Q200(Rev.E) Test No.21</b>	<ul style="list-style-type: none"> <li>Bent depth:2mm</li> <li>Speed:0.5mm/s</li> <li>PCB size:40×100mm</li> <li>PCB thickness:1.6mm</li> <li>Test time:60sec.</li> </ul> 	<ul style="list-style-type: none"> <li>ΔL/L : within ± 10%(Change from an initial value)</li> <li>No abnormal appearance after the test.</li> </ul>
Adhesion strength  <b>AEC-Q200(Rev.E) Test No.22</b>	<ul style="list-style-type: none"> <li>Test time:60±1sec.</li> <li>Pressure:18N</li> <li>Measure after removing pressure.</li> </ul> 	<ul style="list-style-type: none"> <li>ΔL/L : within ± 10%(Change from an initial value)</li> <li>No abnormal appearance after the test.</li> </ul>

# Power Inductor FPA322520D

## 12. Temperature Range

- **Operating Temperature range: -40°C to +125°C**

※ Operating temperature range includes self-temperature rise.

※ The part temperature (ambient + temp rise) should not exceed 125°C under worst case operating conditions.

Circuit design, component placement, PCB trace size and thickness, airflow and other cooling provisions all affect the part temperature.

Part temperature should be verified in the end application.

- **Taping Package Storage Temperature range: +5°C to +40°C**

## 13. Reminders

- 请交货规格书的规定内使用

Do not use for a purpose outside of the contents regulated in the delivery specifications.

- 额定电流/ Rated current

- 请勿超过额定电流使用。

Do not exceed the rated current.

- 如果使用超过额定电流，绝缘电阻可能会下降，并且可能会产生过热现象

If it is used exceeding the rated current, insulation resistance may decrease and excessive heat generation may occur.

- 如产品出现任何异常或故障，请务必在成品中添加适当的失效保护功能，以防止次生灾害的发生

In case of any abnormality or malfunction of our products, be sure to add the appropriate Fail safe function to the finished product to prevent secondary disasters.

存储方法/ Storage method

- 存储期限不超过6个月。请务必遵循存储条件（温度：5至40°C，湿度：20至75% RH或更低）

The storage period is less than 6 months. Be sure to follow the storage conditions (temperature: 5 to 40°C, humidity: 20 to 75% RH or less).

- ※ 超过保管期限时，端子电极的焊接性可能会劣化。

If the storage period elapses, the soldering of the terminal electrodes may deteriorate

- ※ 请避免在阳光直射、振动等场所保管。

Avoid storage in places subject to direct sunlight, vibration, etc.

- ※ 请勿在受气体腐蚀影响的环境（氯气、酸、碱、硫化气体等）中使用、保管。

Do not use or store in an environment (chlorine gas, acid, alkali, sulfide gas, etc.) that is affected by gas corrosion.

- 搬运/ Transport

- 请勿产生过度的振动、冲击。

Please do not give excessive vibration and impact.

- 基板安装 / Substrate installation

- 不要在线圈下方设计通孔或布线。

Do not design Through hole or Pattern under Coil.

- 请进行配置设计，避免线圈之间的接触。

Please arrange so that Coil does not touch each other.

- 将电路板装入设备时，请确保不要因为螺钉紧固部位或类似原因导致板子变形而对线圈施加压力。

When incorporating the circuit board into the SET, be sure not to apply stress to the Coil due to distortion of the board due to Screw fastening part or the like.

- 请考虑线圈的自我发热进行热设计。

Self heating (temperature increase) occurs when the power is turned ON, so the tolerance should be sufficient for the set thermal design.

- 焊锡修正方法 / Soldering correction method

- 预热：150°C 1分钟

Pre Heat : 150°C 1min.

- 烙铁头功率：80W以下

Soldering tip power: 80 W or less

- 烙铁头温度：不超过350

Soldering tip temperature: 350 °C or less

- 烙铁头直径：不超过Φ 3 mm

Soldering tip diameter: Φ 3 mm or less

- 修复时间：3秒以内

work time: within 3 seconds

- 请使用腕带（带电状态下请勿触摸线圈）。

Use a wrist band to discharge static electricity in your body through the grounding wire.

- 请勿使磁铁、带磁性的物体靠近。

Do not expose the products to magnets or magnetic fields.

- 关于树脂涂层，请注意树脂的选择，在安装的状态下实施可靠性评价。

For resin Coating, pay attention to resin selection and perform reliability evaluation in the mounted state.

- 本产品以用于一般民生电子设备（家电产品、通信设备、计算机设备等）和汽车用信息娱乐/舒适设备为前提。

This product is based on the premise of being used for general livelihood electronic equipment (household appliances, communication equipment, computer equipment, etc.) and automotive infotainment/comfort equipment.



## Power Inductor FPA322520D

○ 本目录中列出的产品旨在用于正常操作和使用条件下的一般电子设备（家用电器、电信设备、计算机设备）。这些产品并未设计或保证满足以下应用的要求，这些应用对性能和/或质量要求更高的安全性或可靠性水平，或者其故障、失效或问题可能对社会、人员或财产造成严重损害。

The products listed on this catalog are intended for use in general electronic equipment (home appliances, telecommunications equipment, computer equipment) under a normal operation and use condition. The products are not designed or warranted to meet the requirements of the applications listed below, whose performance and/or quality require a more stringent level of safety or reliability, or whose failure, malfunction or trouble could cause serious damage to society, person or property.

- 航空/宇宙机器  
Aerospace/aviation equipment
- 医疗器械  
Medical equipment
- 发电控制用机器  
Power-generation control equipment
- 原子能相关机器  
Atomic energy-related equipment
- 军用机器  
Military equipment
- 安全装置  
Safety equipment
- 海底作业用机器  
Seabed equipment
- 交通工具控制机器  
Transportation control equipment
- 信息处理机器（公共性高的机器）  
Public information-processing equipment
- 公共运输用机器（列车、船舶等）  
Transportation equipment (electric trains, ships, etc.)
- 防灾/防盗机器  
Disaster prevention/crime prevention equipment
- 非通用的其他用途  
Other applications that are not considered general-purpose applications