

Specification for Approval

Customer	
Product Name	Wire Wound Molded SMD Power Inductors
Customer P/N:	
Cjiang P/N:	FXL series

[New Released, Revised]

SPEC No.:

REMARK:		
Customer Approval Feedback		

●深圳市长江微电科技有限公司

SZ CJIANG TECHNOLOGY CO.,LTD

ADD: 11F, International Science and Technology Building, Fuhong Road, Futian District, Shenzhen

Factory ADD:No. shanyang RD CJIANG Industrial Park HUAi'AN Section HUAi'AN City Jiangsu Province

TEL: 0755-82529562 FAX:0755-83977004

<http://www.CJING.COM.CN>

E-mail: BOND@Cjiang.com.cn; ann@cjiang.com.cn

深圳市长江微电科技有限公司
SZ CJIANG TECHNOLOGY CO.,LTD

Version change history

Rev	Date	Description	APPROVED	CHECKED	DRAWN
1.0	2023/11/17	Document formulation	徐舒霞	马月	朱小娟
2.0	2024/1/25	Increase Isat/Irms Max	BOND	MIKO	MIKO
3.0	2024/3/25	Merge all sizes	BOND	XUETING	XUETING

Caution :

All products listed in this specification are developed, designed and intended for use in general electronics equipment. The products are not designed or Warranted to meet the requirements of the applications listed below, whose performance and/or quality require especially high reliability, or whose failure, malfunction or trouble might directly cause damage to society, person, or property. Please understand that we are not responsible for any damage or liability caused by use of the products in any of the applications below. Please contact us for more details if you intend to use our products in the following applications.

1. Aircraft equipment.
2. Aerospace equipment.
3. Undersea equipment.
4. nuclear control equipment.
5. military equipment.
6. Power plant equipment.
7. Medical equipment.
8. Transportation equipment (automobiles, trains, ships,etc.)
9. Traffic signal equipment.
10. Disaster prevention / crime prevention equipment.
11. Data-processing equipment.
12. Applications of similar complexity or with reliability requirements comparable to the applications listed in the above.



introduction

- Halogen Free ,ROHS compliance
- High rated current
- 125°C maximum total temperature operation
- 4.75 x 4.45 x 1.2mm maximum surface mount package
- Low core loss
- Ultra low buzz noise due to molding construction



Applications

- Laptops and PCs
- Switch and servers
- Base stations
- DC/DC converters
- Battery powered devices
- SSD modules

Product Identification

FXL 0412 --1R5 - M
① ② ③ ④

- ① FXL ----- Series name
- ② 0412 ----- Dimension
- ③ 1R5 ----- Inductance Value (1R5 = 1.5 μ H)
- ④ M ----- Inductance Tolerance (M= \pm 20%)

Dimensions (unit:mm)

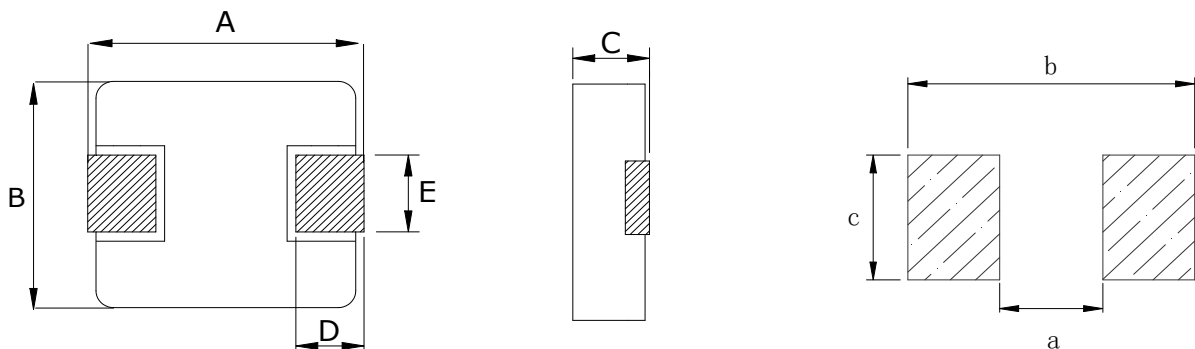

Recommend Land Pattern

深圳市长江微电科技有限公司
SZ CJIANG TECHNOLOGY CO.,LTD

series	A	B	C	D	E	a typ	b typ	c typ
FXL0412	4.4±0.35	4.2±0.25	1.0±0.2	0.8±0.3	2.0±0.3	2.2	5.2	2.5
FXL0420	4.4±0.35	4.2±0.25	1.8±0.2	0.8±0.3	2.0±0.3	2.2	5.2	2.5
FXL0518	5.4±0.35	5.2±0.2	1.6±0.2	1.2±0.2	2.2±0.3	2.2	6	2.5
FXL0530	5.4±0.35	5.2±0.2	2.8±0.2	1.2±0.2	2.2±0.3	2.2	6	2.5
FXL0615	7.0±0.3	6.6±0.2	1.3±0.2	1.6±0.3	3.0±0.3	3.7	8.4	3.5
FXL0618	7.0±0.3	6.6±0.2	1.6±0.2	1.6±0.3	3.0±0.3	3.7	8.4	3.5
FXL0624	7.0±0.3	6.6±0.2	2.2±0.2	1.6±0.3	3.0±0.3	3.7	8.4	3.5
FXL0630	7.0±0.3	6.6±0.2	2.8±0.2	1.6±0.3	3.0±0.3	3.7	8.4	3.5
FXL0640	7.0±0.3	6.6±0.2	3.8±0.2	1.6±0.3	3.0±0.3	3.7	8.4	3.5
FXL0650	7.0±0.3	6.6±0.2	4.8±0.2	1.6±0.3	3.0±0.3	3.7	8.4	3.5
FXL0840	8.8±0.4	8.2±0.3	3.8±0.2	1.4±0.3	5.0±0.3	4	9.5	5.5
FXL1030	11.5MAX	10.0±0.3	2.8±0.2	2.0±0.5	3.0±0.5	5.4	13.6	4.1
FXL1040	11.5MAX	10.0±0.3	3.8±0.2	2.0±0.5	3.0±0.5	5.4	13.6	4.1
FXL1050	11.5MAX	10.0±0.3	4.8±0.2	2.0±0.5	3.0±0.5	5.4	13.6	4.1
FXL1340	13.45±0.35	12.8±0.5	4.0MAX	2.0±0.5	See remarks	8	14.5	5.5
FXL1350	13.45±0.35	12.6±0.3	4.8±0.2	2.0±0.5	See remarks	8	14.5	5.5
FXL1360	13.45±0.35	12.6±0.3	5.8±0.2	2.0±0.5	See remarks	8	14.5	5.5
FXL1365	13.45±0.35	12.6±0.3	6.5MAX	2.0±0.5	5.0±0.3	8	14.5	5.5
FXL1770	17.15±0.35	17.15MAX	7.0MAX	2.5±0.5	12.0±0.3	11.2	18.2	12.8
FXL2213	23.5±0.5	22.0±0.3	12.6±0.4	5.0±0.4	19.0±0.3	12.5	24	19.6

Remarks:

series	E	Dimensions
FXL1340	3.85±0.5	R22/R47
	5.0±0.3	R68/R82/1R0/1R5/2R2/3R3/4R7/6R8/100/150/220
FXL1350	3.85±0.5	R22/R36/R50/R68/R82/1R0/1R5/2R2
	5.0±0.3	3R3/4R7/6R8/8R2/100/150/220/330/470
FXL1360	3.85±0.5	1R0/2R2
	5.0±0.3	4R7/5R6/6R8/8R2/100/150/180/220/270/330/470/680/101/121/151

Marking

The inductor is marked with a 3-digit code

Nominal Inductance	
Example	Nominal Value
1R0	1.0 μ H
100	10 μ H
101	100 μ H

Note : Using Ink for marking

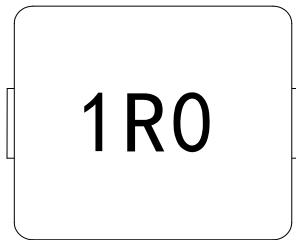

Structure and Components

Symbol	Components	Material
a	MARKING	Ink (black)
b	CORE	Alloy Sponge Powder
c	WIRE	Polyurethane copper wire
d	Terminal	Copper plated with Sn

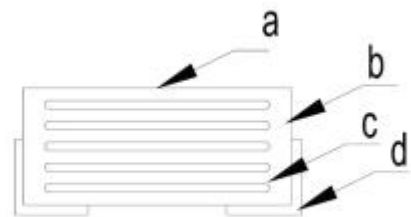

深圳市长江微电科技有限公司
SZ CJIANG TECHNOLOGY CO.,LTD

Appendix A: Electrical Characteristics

FXL0412-XXX series

Part No.	Inductance	DC Resistance	Saturation Current	Saturation Current	Heating Rating Current	Heating Rating Current
	L0 (μH)	DCR (mΩ)	Isat (A)	Isat (A)	Irms (A)	Irms (A)
	±20 %, 100 kHz, 1V	MAX.	MAX	TYP.	MAX	TYP.
FXL0412-R15-M	0.15	9	12	15	6.8	7.5
FXL0412-R22-M	0.22	11	8.8	11	6.5	7
FXL0412-R33-M	0.33	19	6.7	8.4	5.7	6.5
FXL0412-R47-M	0.47	21	5.4	6.8	5.2	6
FXL0412-R68-M	0.68	36	4.8	6	4.2	4.7
FXL0412-1R0-M	1.0	47	4.4	5.5	3.8	4.5
FXL0412-1R5-M	1.5	75	3.2	4	2.7	3.25
FXL0412-2R2-M	2.2	83.5	2.4	3.5	2.2	2.75
FXL0412-3R3-M	3.3	165	2.38	3	1.77	2
FXL0412-4R7-M	4.7	195	1.80	2.8	1.45	1.8

FXL0420-XXX series

Part No.	Inductance	DC Resistance	Saturation Current	Saturation Current	Heating Rating Current	Heating Rating Current
	L0 (μH)	DCR (mΩ)	Isat (A)	Isat (A)	Irms (A)	Irms (A)
	±20 %, 100 kHz, 1V	MAX.	MAX	TYP.	MAX	TYP.
FXL0420-R10-M	0.1	4	17.6	22	11.2	13
FXL0420-R22-M	0.22	6.6	10	12.5	8.2	9.5
FXL0420-R33-M	0.33	11	9.6	12	8.6	10
FXL0420-R47-M	0.47	14	7.6	9.5	6.65	7.5
FXL0420-R56-M	0.56	16	7.2	10	6.1	7
FXL0420-R68-M	0.68	18	6.4	9	6.15	7
FXL0420-1R0-M	1.0	27	5.6	7	5.4	6
FXL0420-1R2-M	1.2	27	5.2	7	5.4	6
FXL0420-1R5-M	1.5	46	4.4	6	4.3	5
FXL0420-2R2-M	2.2	58	4.0	5	3.8	4.5
FXL0420-3R3-M	3.3	87	2.8	4	2.8	3.3
FXL0420-4R7-M	4.7	105	2.4	3	2.2	2.8
FXL0420-6R8-M	6.8	175	2.0	2.5	1.9	2.4
FXL0420-100-M	10	282	1.6	2.2	1.3	1.6
FXL0420-220-M	22	363	1.12	1.4	0.9	1.2

深圳市长江微电科技有限公司
SZ CJIANG TECHNOLOGY CO.,LTD

FXL0518-XXX series

Part No.	Inductance	DC Resistance	Saturation Current	Saturation Current	Heating Rating Current	Heating Rating Current
	L0 (μH)	DCR (mΩ)	Isat (A)	Isat (A)	Irms (A)	Irms (A)
	±20 %, 100 kHz, 1V	MAX.	MAX	TYP.	MAX	TYP.
FXL0518-R47-M	0.47	9	9.6	15.5	9.5	10.5
FXL0518-R56-M	0.56	10	8.8	15	8.2	9.5
FXL0518-R68-M	0.68	13.8	9.3	11.2	7.7	8.9
FXL0518-1R0-M	1.0	17	7.2	9	7.2	8
FXL0518-1R5-M	1.5	26	6.4	9	6.6	7.5
FXL0518-2R2-M	2.2	35	4.8	6.5	4.2	5
FXL0518-3R3-M	3.3	58	3.84	5	3.8	4.5
FXL0518-4R7-M	4.7	85	3.2	4	3.0	3.5
FXL0518-6R8-M	6.8	120	2.72	3.4	2.4	2.8
FXL0518-100-M	10	155	2	3	2.2	2.5

FXL0530-XXX series

Part No.	Inductance	DC Resistance	Saturation Current	Saturation Current	Heating Rating Current	Heating Rating Current
	L0 (μH)	DCR (mΩ)	Isat (A)	Isat (A)	Irms (A)	Irms (A)
	±20 %, 100 kHz, 1V	MAX.	MAX	TYP.	MAX	TYP.
FXL0530-R10-M	0.10	3	24	33	23	25
FXL0530-R20-M	0.20	3.9	11.6	14.5	13	14
FXL0530-R33-M	0.33	5.5	14.4	18	13.1	14
FXL0530-R47-M	0.47	8.5	9.6	12	10	11
FXL0530-R68-M	0.68	12	9.2	11.5	8.2	9.0
FXL0530-1R0-M	1.0	14	8	11	7.8	8.5
FXL0530-1R2-M	1.2	16	7.6	11	7.85	8.5
FXL0530-1R5-M	1.5	25	7.2	8.5	7.6	8.2
FXL0530-2R2-M	2.2	29	5.6	7.5	6.4	7.0
FXL0530-3R3-M	3.3	38	4.8	6.0	5	5.5
FXL0530-4R7-M	4.7	60	3.68	5	4	4.5
FXL0530-6R8-M	6.8	90	2.88	4	2.9	3.5
FXL0530-100-M	10	125	2.8	3.5	2.8	3.2
FXL0530-150-M	15	180	2.0	2.2	1.6	1.7
FXL0530-220-M	22	248	2.0	2.3	1.5	1.7

深圳市长江微电科技有限公司
SZ CJIANG TECHNOLOGY CO.,LTD

FXL0615-XXX series

Part No.	Inductance	DC Resistance	Saturation Current	Saturation Current	Heating Rating Current	Heating Rating Current
	L0 (μH)	DCR (mΩ)	Isat (A)	Isat (A)	Irms (A)	Irms (A)
	±20 %, 100 kHz, 1V	MAX.	MAX	TYP.	MAX	TYP.
FXL0615-R47-M	0.47	8.5	14.16	16	8.85	10
FXL0615-R56-M	0.56	11	12.38	14	7.96	9
FXL0615-R68-M	0.68	12	10.62	12	7.52	8.5
FXL0615-R82-M	0.82	17	8.85	10	7.08	8
FXL0615-1R0-M	1.0	21	7.96	9	5.3	6
FXL0615-1R5-M	1.5	45	6.2	7	3.4	4
FXL0615-2R2-M	2.2	54	6.19	7	3.36	3.8
FXL0615-3R3-M	3.3	63	4.87	5.5	3.1	3.5
FXL0615-4R7-M	4.7	85	4.42	5	2.83	3.2
FXL0615-6R8-M	6.8	135	3.54	4	2.21	2.5
FXL0615-100-M	10	175	2.65	3	1.77	2

FXL0618-XXX series

Part No.	Inductance	DC Resistance	Saturation Current	Saturation Current	Heating Rating Current	Heating Rating Current
	L0 (μH)	DCR (mΩ)	Isat (A)	Isat (A)	Irms (A)	Irms (A)
	±20 %, 100 kHz, 1V	MAX.	MAX	TYP.	MAX	TYP.
FXL0618-R10-M	0.1	2.3	30.4	38	23	25
FXL0618-R22-M	0.22	3.5	19.2	24	20	22
FXL0618-R47-M	0.47	8.4	16.0	18	10	11.5
FXL0618-R68-M	0.68	12	13.2	17	8.4	9.5
FXL0618-1R0-M	1.0	16	9.6	14	7.6	8.5
FXL0618-1R5-M	1.5	26	7.36	12	7.1	8.0
FXL0618-2R2-M	2.2	35	6.4	8	6.2	7
FXL0618-3R3-M	3.3	50	4.8	6.5	3.8	4.5
FXL0618-4R7-M	4.7	62	4.0	5	3.5	4
FXL0618-6R8-M	6.8	110	3.6	4.5	2.4	3.0
FXL0618-100-M	10	155	3.2	4	1.95	2.3
FXL0618-220-M	22	350	1.84	2.3	1.4	1.8

深圳市长江微电科技有限公司
SZ CJIANG TECHNOLOGY CO.,LTD

FXL0624-XXX series

Part No.	Inductance	DC Resistance	Saturation Current	Saturation Current	Heating Rating Current	Heating Rating Current
	L0 (μH)	DCR (mΩ)	Isat (A)	Isat (A)	Irms (A)	Irms (A)
	±20 %, 100 kHz, 1V	MAX.	MAX	TYP.	MAX	TYP.
FXL0624-R22-M	0.22	3	24	34	19	21
FXL0624-R33-M	0.33	4.1	19.6	24.5	16	18
FXL0624-R47-M	0.47	5.1	16	22	13.5	15
FXL0624-R56-M	0.56	6.5	13.6	17	11.5	13
FXL0624-R68-M	0.68	7	12.8	16	10.5	12
FXL0624-1R0-M	1.0	13.5	12.0	16	8	9
FXL0624-1R5-M	1.5	20	10.8	15	7	9
FXL0624-2R2-M	2.2	28	8	10	6.2	7
FXL0624-3R3-M	3.3	39	6.4	8	4.8	5.5
FXL0624-4R7-M	4.7	50	5.2	7.5	4.3	5
FXL0624-6R8-M	6.8	70	4.8	6	3.2	4
FXL0624-100-M	10	101	3.2	4	2.4	3.1
FXL0624-150-M	15	160	2.64	3.3	2.0	2.5
FXL0624-220-M	22	230	2.0	2.5	1.6	2

FXL0630-XXX series

Part No.	Inductance	DC Resistance	Saturation Current		Heating Rating Current	
	L0 (μH)	DCR (mΩ)	Isat (A)		Irms (A)	
	±20 %, 100 kHz, 1V	MAX.	Max	Typ	Max	Typ
FXL0630-R10-M	0.1	0.99	48	60	35	40
FXL0630-R15-M	0.15	2.4	35	41	25	30
FXL0630-R22-M	0.22	3	32	34	21	24
FXL0630-R24-M	0.24	3.1	22.4	28	18.4	23
FXL0630-R33-M	0.33	3.5	22	25	20	21
FXL0630-R47-M	0.47	4.1	18	20	16	18
FXL0630-R56-M	0.56	4.5	16	18	15	16.5
FXL0630-R68-M	0.68	5.3	15	17	14.5	16
FXL0630-R82-M	0.82	6.0	14	16	13	14
FXL0630-1R0-M	1.0	7.4	13.5	15	11.2	12

深圳市长江微电科技有限公司
SZ CJIANG TECHNOLOGY CO.,LTD

FXL0630-1R5-M	1.5	12.1	12	14	9.5	12
FXL0630-2R2-M	2.2	15	10.5	12	8.5	9.5
FXL0630-2R7-M	2.7	20	9	10	8.2	8.8
FXL0630-3R3-M	3.3	22	8.7	9.5	8	8.5
FXL0630-4R7-M	4.7	33	7.5	9	5.5	6
FXL0630-5R6-M	5.6	42	5.5	6.5	5	5.5
FXL0630-6R8-M	6.8	48	5.2	6	4.5	5
FXL0630-8R2-M	8.2	60	5	5.5	4	5
FXL0630-100-M	10	68	4.9	5.5	3.8	4.5
FXL0630-150-M	15	115	3.5	4.0	2.6	3
FXL0630-220-M	22	200	2.5	3	2.2	2.5
FXL0630-330-M	33	310	2.1	2.5	1.8	2
FXL0630-470-M	47	385	1.8	2	1.3	1.5

FXL0640-XXX series

Part No.	Inductance	DC Resistance	Saturation Current	Saturation Current	Heating Rating Current	Heating Rating Current
	L0 (μH)	DCR (mΩ)	Isat (A)	Isat (A)	Irms (A)	Irms (A)
	±20 %, 100 kHz, 1V	MAX.	MAX	TYP.	MAX	TYP.
FXL0640-R15-M	0.15	0.66±7%	45	50	36	40
FXL0640-R22-M	0.22	0.98±7%	28	35	32	35
FXL0640-R68-M	0.68	4.8	17	19	16	17
FXL0640-1R0-M	1.0	6.6	15	16	12.5	13.5
FXL0640-1R5-M	1.5	10	12	12.5	11	12.4
FXL0640-2R2-M	2.2	14	10	11	8.5	10
FXL0640-3R3-M	3.3	20	8.7	9.5	7.8	8.5
FXL0640-4R7-M	4.7	30	8	9	6	6.5
FXL0640-6R8-M	6.8	45	6	6.5	5	5.5
FXL0640-8R2-M	8.2	55	5.0	6	4.2	5.2
FXL0640-100-M	10	65	5	6	4	4.8
FXL0640-150-M	15	95	4	4.5	3.2	3.7
FXL0640-220-M	22	125	3.5	4	3	3.3
FXL0640-330-M	33	240	2.5	3	2	2.2
FXL0640-470-M	47	320	2	2.5	1.6	1.8

深圳市长江微电科技有限公司
SZ CJIANG TECHNOLOGY CO.,LTD

FXL0650-XXX series

Part No.	Inductance	DC Resistance	Saturation Current	Saturation Current	Heating Rating Current	Heating Rating Current
	L0 (μH)	DCR (mΩ)	Isat (A)	Isat (A)	Irms (A)	Irms (A)
	±20 %, 100 kHz, 1V	MAX.	MAX	TYP.	MAX	TYP.
FXL0650-R47-M	0.47	3.9	16.8	21	17.0	20
FXL0650-R68-M	0.68	4.5	14.4	18	14.5	16.5
FXL0650-1R0-M	1.0	6.6	12.8	16	10	12
FXL0650-1R5-M	1.5	10	10.4	13	8.2	9.5
FXL0650-2R2-M	2.2	12.5	8.8	11	8.0	9
FXL0650-3R3-M	3.3	22	8.0	10	7.6	8.5
FXL0650-4R7-M	4.7	29	6.4	8	5	6
FXL0650-6R8-M	6.8	41	5.04	6.3	4	5.8
FXL0650-8R2-M	8.2	48	4.4	5.5	4.8	5.5
FXL0650-100-M	10	60	4.24	5.3	3.8	4.5
FXL0650-150-M	15	90	3.2	4	2.6	3.1
FXL0650-220-M	22	140	2.8	3.5	2	2.6
FXL0650-330-M	33	190	2.4	3.0	1.8	2.3
FXL0650-470-M	47	230	2.08	2.6	1.5	2

FXL0840-XXX series

Part No.	Inductance	DC Resistance	Saturation Current	Saturation Current	Heating Rating Current	Heating Rating Current
	L0 (μH)	DCR (mΩ)	Isat (A)	Isat (A)	Irms (A)	Irms (A)
	±20 %, 100 kHz, 1V	MAX.	MAX	TYP.	MAX	TYP.
FXL0840-R22-M	0.22	1.8	55	60	30	36
FXL0840-R33-M	0.33	2.4	40	45	25	30
FXL0840-R47-M	0.47	2.8	36	42	25	28
FXL0840-R56-M	0.56	3.2	23	26	22	24
FXL0840-R68-M	0.68	3.8	22	24	21	23
FXL0840-R82-M	0.82	4.4	19	21	19	21
FXL0840-1R0-M	1.0	4.62	17	19	17	19
FXL0840-1R5-M	1.5	7.6	15	17	15	17
FXL0840-1R8-M	1.8	11	13.5	15	12.5	15
FXL0840-2R2-M	2.2	11.4	12	14	12	14
FXL0840-3R3-M	3.3	15	11	12.5	10	12
FXL0840-4R7-M	4.7	26.5	10.5	11.5	8.5	9.5

深圳市长江微电科技有限公司
SZ CJIANG TECHNOLOGY CO.,LTD

FXL0840-5R6-M	5.6	30	10	11	8.0	9
FXL0840-6R8-M	6.8	36.8	8.0	9	7.0	8
FXL0840-8R2-M	8.2	46	7.7	8.7	6.0	7
FXL0840-100-M	10.0	59	7.0	8	5.5	6.5
FXL0840-150-M	15.0	71	4.9	5.5	4.8	5.4
FXL0840-220-M	22.0	113	4.5	5	4.2	4.8
FXL0840-330-M	33.0	156	3.3	3.5	3.0	3.5
FXL0840-470-M	47.0	225	2.9	3.1	2.5	2.9

FXL1030-XXX series

Part No.	Inductance	DC Resistance	Saturation Current	Saturation Current	Heating Rating Current	Heating Rating Current
	L0 (μH)	DCR (mΩ)	Isat (A)	Isat (A)	Irms (A)	Irms (A)
	±20 %, 100 kHz, 1V	MAX.	MAX	TYP.	MAX	TYP.
FXL1030-R22-M	0.22	1.2	44.24	50	29.2	33
FXL1030-R33-M	0.33	1.6	28.3	32	20.35	23
FXL1030-R36-M	0.36	1.6	24.8	28	20.35	23
FXL1030-R47-M	0.47	2.5	23.0	26	19.47	22
FXL1030-R82-M	0.82	3.7	20.35	23	15.93	18
FXL1030-1R0-M	1.0	6	18.58	21	13.27	15
FXL1030-2R2-M	2.2	9	12.38	14	9.73	11
FXL1030-3R3-M	3.3	16	10.61	12	7.96	9
FXL1030-4R7-M	4.7	24	8.84	10	6.19	7
FXL1030-8R2-M	8.2	45	6.2	7	4.42	5
FXL1030-330-M	33	160	3.53	4	2.3	2.6

FXL1040-XXX series

Part No.	Inductance	DC Resistance	Saturation Current	Saturation Current	Heating Rating Current	Heating Rating Current
	L0 (μH)	DCR (mΩ)	Isat (A)	Isat (A)	Irms (A)	Irms (A)
	±20 %, 100 kHz, 1V	MAX.	MAX	TYP.	MAX	TYP.
FXL1040-R15-M	0.15	0.65	60	75	40	45
FXL1040-R22-M	0.22	1	48	60	30	35
FXL1040-R30-M	0.30	1.1	36	50	30	35

深圳市长江微电科技有限公司
SZ CJIANG TECHNOLOGY CO.,LTD

FXL1040-R36-M	0.36	1.2	36	50	25	30
FXL1040-R47-M	0.47	1.7	32	40	25	30
FXL1040-R56-M	0.56	1.8	26.4	33	20	25
FXL1040-R68-M	0.68	2.4	24	30	19	23
FXL1040-R80-M	0.80	2.7	23.2	29	19	23
FXL1040-1R0-M	1.0	3.3	22.4	28	16	19
FXL1040-1R5-M	1.5	4.2	19.2	26	14	16
FXL1040-2R2-M	2.2	7	13.2	18	10	12
FXL1040-3R3-M	3.3	11.8	12.8	16	9.5	11
FXL1040-4R7-M	4.7	20	10.4	15	7.5	9
FXL1040-5R6-M	5.6	22	9.6	12	6.8	8.5
FXL1040-6R8-M	6.8	25	9.6	12	7	8.5
FXL1040-8R2-M	8.2	27	7.2	9	6.8	8
FXL1040-100-M	10	30	6.8	8.5	6.9	7.8
FXL1040-150-M	15	45	5.6	7	5.6	6.5
FXL1040-220-M	22	66	4.4	5.5	4.2	5
FXL1040-330-M	33	92	3.84	5	3.8	4.4
FXL1040-470-M	47	145	3.1	3.5	2.8	3.3
FXL1040-560-M	56	185	2.5	3.2	2.2	2.8
FXL1040-680-M	68	195	2.4	3	2	2.5
FXL1040-820-M	82	285	2.3	2.8	2.1	2.3
FXL1040-101-M	100	340	2.1	2.3	1.8	2

FXL1050-XXX series

Part No.	Inductance	DC Resistance	Saturation Current	Saturation Current	Heating Rating Current	Heating Rating Current
	L0 (μH)	DCR (mΩ)	Isat (A)	Isat (A)	Irms (A)	Irms (A)
	±20 %, 100 kHz, 1V	MAX.	MAX	TYP.	MAX	TYP.
FXL1050-R22-M	0.22	0.8	57.5	65	32.5	37
FXL1050-1R0-M	1.0	3	28	30	20.3	23
FXL1050-1R5-M	1.5	3.8	22	25	18.5	21
FXL1050-2R2-M	2.2	6	16.8	19	13.2	15
FXL1050-3R3-M	3.3	10	14	16	11.5	13
FXL1050-4R7-M	4.7	14	13.2	15	9.7	11
FXL1050-5R6-M	5.6	17	12.3	14	8.5	9.5

深圳市长江微电科技有限公司
SZ CJIANG TECHNOLOGY CO.,LTD

FXL1050-6R8-M	6.8	18.5	12.3	14	8.0	9
FXL1050-100-M	10	28	8.8	10	7.0	8
FXL1050-150-M	15	42	6.5	7.5	5.7	6.5
FXL1050-220-M	22	50	5.3	6	5.0	5.5
FXL1050-330-M	33	86	4.6	5.2	4.2	4.8
FXL1050-470-M	47	127	4.0	4.5	3.2	3.7
FXL1050-680-M	68	180	2.8	3.5	2.4	2.7
FXL1050-101-M	100	290	2.5	2.8	1.8	2.1

FXL1340-XXX series

Part No.	Inductance	DC Resistance	Saturation Current	Saturation Current	Heating Rating Current	Heating Rating Current
	L0 (μH)	DCR (mΩ)	Isat (A)	Isat (A)	Irms (A)	Irms (A)
	±20 %, 100 kHz, 1V	MAX.	MAX	TYP.	MAX	TYP.
FXL1340-R22-M	0.22	0.9	40	50	38	42
FXL1340-R47-M	0.47	2	38.4	48	29	33
FXL1340-R68-M	0.68	3.5	37.6	47	24	28
FXL1340-R82-M	0.82	4.5	32	40	24	28
FXL1340-1R0-M	1.0	7.5	28	35	20	24
FXL1340-1R5-M	1.5	9.5	24.4	30.5	17	20
FXL1340-2R2-M	2.2	11.5	20.8	26	15	18
FXL1340-3R3-M	3.3	13	16.8	21	13	15
FXL1340-4R7-M	4.7	14.5	14.4	18	11	13
FXL1340-6R8-M	6.8	20	11.2	14	8	9
FXL1340-100-M	10	25	8	10	7	8
FXL1340-150-M	15	39	6	7.5	5.8	6.5
FXL1340-220-M	22	51	4.8	6	3.8	4.5

深圳市长江微电科技有限公司
SZ CJIANG TECHNOLOGY CO.,LTD

FXL1350-XXX series

Part No.	Inductance	DC Resistance	Saturation Current	Saturation Current	Heating Rating Current	Heating Rating Current
	L0 (μH)	DCR (mΩ)	Isat (A)	Isat (A)	Irms (A)	Irms (A)
	±20 %, 100 kHz, 1V	MAX.	MAX	TYP.	MAX	TYP.
FXL1350-R22-M	0.22	0.7	60	75	45	50
FXL1350-R36-M	0.36	0.85	40	50	37	42
FXL1350-R50-M	0.50	1.15	38.4	48	33	38
FXL1350-R68-M	0.68	1.55	36.8	46	29	33
FXL1350-R82-M	0.82	1.67	31.2	39	26	30
FXL1350-1R0-M	1.0	2.2	28	35	22	26
FXL1350-1R5-M	1.5	3.2	26.4	33	19	23
FXL1350-2R2-M	2.2	5	19.2	24	13	15
FXL1350-3R3-M	3.3	7	17.6	22	12	14
FXL1350-4R7-M	4.7	9	16	21	11	13
FXL1350-6R8-M	6.8	18	12.8	16	10	12
FXL1350-8R2-M	8.2	20	11	13	8.2	9.5
FXL1350-100-M	10	22	9.6	12	8	9
FXL1350-150-M	15	30	8	10	7	8
FXL1350-220-M	22	58	5.2	6.5	3.8	4.5
FXL1350-330-M	33	84	4.8	6	2.8	3.5
FXL1350-470-M	47	130	4.0	5	2.6	3

FXL1360-XXX series

Part No.	Inductance	DC Resistance	Saturation Current	Saturation Current	Heating Rating Current	Heating Rating Current
	L0 (μH)	DCR (mΩ)	Isat (A)	Isat (A)	Irms (A)	Irms (A)
	±20 %, 100 kHz, 1V	MAX.	MAX	TYP.	MAX	TYP.
FXL1360-1R0-M	1.0	2.3	28	31	24	28
FXL1360-2R2-M	2.2	4.2	24	28	18	22
FXL1360-4R7-M	4.7	9	19.2	24	12	15
FXL1360-5R6-M	5.6	11	18	22.5	11	13
FXL1360-6R8-M	6.8	13.5	15.2	19	10	12

深圳市长江微电科技有限公司
SZ CJIANG TECHNOLOGY CO.,LTD

FXL1360-8R2-M	8.2	16	10.8	13.5	9	11
FXL1360-100-M	10	20.7	11.1	12.5	8.5	10
FXL1360-120-M	12	23	8	10	5.8	7
FXL1360-150-M	15	29	7.2	9	4.9	6
FXL1360-180-M	18	35	6.4	8	4.3	5
FXL1360-220-M	22	39.5	6	7.5	4.15	5
FXL1360-270-M	27	56	5.2	6.5	3.3	4
FXL1360-330-M	33	75	4.8	6	3.15	4
FXL1360-470-M	47	90	4.4	5.5	2.9	3.5
FXL1360-680-M	68	140	3.6	4.5	2.5	3
FXL1360-101-M	100	200	2.8	3.5	2.1	2.5
FXL1360-121-M	120	235	2.56	3.2	1.7	2
FXL1360-151-M	150	350	2.16	2.7	1.2	1.5

FXL1365-XXX series

Part No.	Inductance	DC Resistance	Saturation Current	Saturation Current	Heating Rating Current	Heating Rating Current
	L0 (μH)	DCR (mΩ)	Isat (A)	Isat (A)	Irms (A)	Irms (A)
	±20 %, 100 kHz, 1V	MAX.	MAX	TYP.	MAX	TYP.
FXL1365-2R2-M	2.2	4.2	22.4	28	16.8	21
FXL1365-4R7-M	4.7	8.5	20	24	13	16
FXL1365-5R6-M	5.6	10.5	18	22.5	12	14
FXL1365-6R8-M	6.8	12	17	19	11	13
FXL1365-8R2-M	8.2	14	14	16	9	12
FXL1365-100-M	10	16.5	13.5	15	10	11
FXL1365-150-M	15	26	8	11	6.5	9.5
FXL1365-220-M	22	36	7	9	6	8
FXL1365-330-M	33	65	6	8	4.8	6.5
FXL1365-470-M	47	70	5	6.8	4.5	5.5
FXL1365-680-M	68	120	4.8	5.2	4.0	4.8
FXL1365-820-M	82	135	4	4.5	3.5	4
FXL1365-101-M	100	170	3.2	4	3	3.5

深圳市长江微电科技有限公司
SZ CJIANG TECHNOLOGY CO.,LTD

FXL1770-XXX series

Part No.	Inductance	DC Resistance	Saturation Current	Saturation Current	Heating Rating Current	Heating Rating Current
	L0 (μH)	DCR (mΩ)	Isat (A)	Isat (A)	Irms (A)	Irms (A)
	±20 %, 100 kHz, 1V	MAX.	MAX	TYP.	MAX	TYP.
FXL1770-2R2-M	2.2	2.5	30	34	25.5	29
FXL1770-3R3-M	3.3	3.95	26	30	21	24
FXL1770-4R7-M	4.7	4.75	21	24	18.5	21
FXL1770-6R8-M	6.8	7.5	19.5	22	15	17
FXL1770-8R2-M	8.2	8.7	17.5	20	11.5	13
FXL1770-100-M	10	9.9	16.5	19	10.5	12
FXL1770-150-M	15	17	12.5	14.5	9.5	11
FXL1770-220-M	22	23	10	11.5	7.5	8.5
FXL1770-330-M	33	37	8.5	10	7	8
FXL1770-470-M	47	47	6.5	7.5	5.3	6
FXL1770-680-M	68	85	5.5	6.5	4.5	5.2
FXL1770-101-M	100	130	4.4	5	3.2	3.7

FXL2213-XXX series

Part No.	Inductance	DC Resistance	Saturation Current	Saturation Current	Heating Rating Current	Heating Rating Current
	L0 (μH)	DCR (mΩ)	Isat (A)	Isat (A)	Irms (A)	Irms (A)
	±20 %, 100 kHz, 1V	MAX.	MAX	TYP.	MAX	TYP.
FXL2213-1R0-M	1.0	0.95	54	60	65	70
FXL2213-1R5-M	1.5	1.15	48	52	57	62
FXL2213-2R2-M	2.2	1.25	43	48	52	58
FXL2213-3R3-M	3.3	1.75	37	41	47	49
FXL2213-4R7-M	4.7	2.2	34	38	44	47
FXL2213-6R8-M	6.8	3.1	32	36	36	40
FXL2213-100-M	10	4.15	20	28	30	33
FXL2213-150-M	15	6.12	18	23	23	26
FXL2213-220-M	22	11	14	15	18	22
FXL2213-330-M	33	15.4	10.5	12	16	19
FXL2213-470-M	47	20.8	10	12	14	17
FXL2213-680-M	68	29.5	9	12	12	14

深圳市长江微电科技有限公司
SZ CJIANG TECHNOLOGY CO.,LTD

FXL2213-820-M	82	34.2	7.7	9	10	12
FXL2213-101-M	100	40	7.5	9	9.5	11

Notes

1. All test data is referenced to 25 °C ambient
2. Operating temperature range - 55 °C to + 125 °C
3. Isat (A) MAX: DC current at which the inductance drops approximately 30% from its value without current.
4. Irms (typ):DC current that causes the temperature rise(AT = 40 C) form 25°C ambient
5. Irms (Max):DC current that causes thetemperature rise(AT = 20°C)form 25°C ambient
6. The part temperature (ambient + temp rise) should not exceed 125°C under worst case operating conditions . Circuit design, component placement, PWB trace size and thickness, airflow and other cooling provisions, all affect the part temperature. Part temperature should be verified in the end application.
7. For FXL series inductors, absolute maximum voltage: DC 30V.

深圳市长江微电科技有限公司
SZ CJIANG TECHNOLOGY CO.,LTD

Mechanical Reliability		
Item	Specification and Requirement	Test Method
Solderability	1. No case deformation or change in appearance 2. New solder coverage More than 95%	1.Preheat: 155℃±5℃ , 60S±2S 2.Tin: lead-free. 3.Temperature:240℃±5℃, flux 3.0S±0.5S.
Mechanical shock	1. No case deformation or change in appearance 2. $\Delta L/L_0 \leq \pm 10\%$	1. Acceleration: 100G 2. Pulse time: 6ms 3. 3 times in each positive and negative direction of 3 mutual perpendicular directions
Mechanical vibration	1. No case deformation or change in appearance 2. $\Delta L/L_0 \leq \pm 10\%$	1. Reflow: 2times 2. Frequency: 10HZ~55HZ~10HZ, 20 Min/Cycles 3. Amplitude: 1.52 mm 4. Directions: X,Y,Z 5. Time: 12 cycle / direction
Endurance Reliability		
Item	Specification and Requirement	Test Method
Thermal Shock	Inductance change: Within $\pm 10\%$ Without distinct damage in appearance	1. First -55℃ for 30 minutes, last 125℃ for 30 minutes as 1 cycle. Go through 1000 cycles. 2. Max transfer time is 3 minutes. 3. Measured at room temperature after placing for 24±2 hours
Humidity Resistance	Inductance change: Within $\pm 10\%$ Without distinct damage in appearance	1.Reflow 2 times, 2.85℃,85%RH,1000 hours 3.Measured at room temperature after placing for 24±2 hours
Low temperature storage	Inductance change: Within $\pm 10\%$ Without distinct damage in appearance	1. Temperature: -55 ± 2℃ 2. Time: 1000 hours 3. Measured at room temperature after placing for 24±2 hours
High temperature storage	Inductance change: Within $\pm 10\%$ Without distinct damage in appearance	1. Temperature: +125 ± 2℃ 2. Time: 1000 hours 3. Measured at room temperature after placing for 24±2 hours

Recommended Soldering Technologies

(1)Re-flowing Profile

Preheat condition: 150 ~200°C/60~120sec.

Allowed time above 217°C: 60~90sec.

Max temp: 260°C

Max time at max temp: 10 sec.

Solder paste: Sn/3.0Ag/0.5Cu

Allowed Reflow time: 2x max

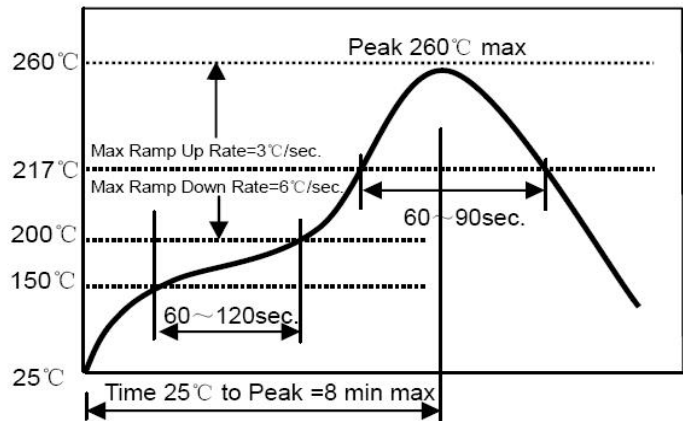

(2)Iron Soldering Profile

Iron soldering power: Max. 30W

Pre-heating: 150°C/60sec.

Soldering Tip temperature: 350°C Max.

Soldering time: 3sec. Max.

Solder paste: Sn/3.0Ag/0.5Cu

Max.1 times for iron soldering

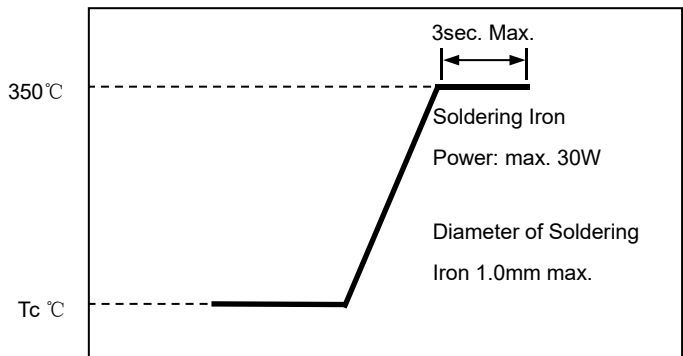

Packaging Information

(1) Tape Packaging Dimensions (Unit: mm)

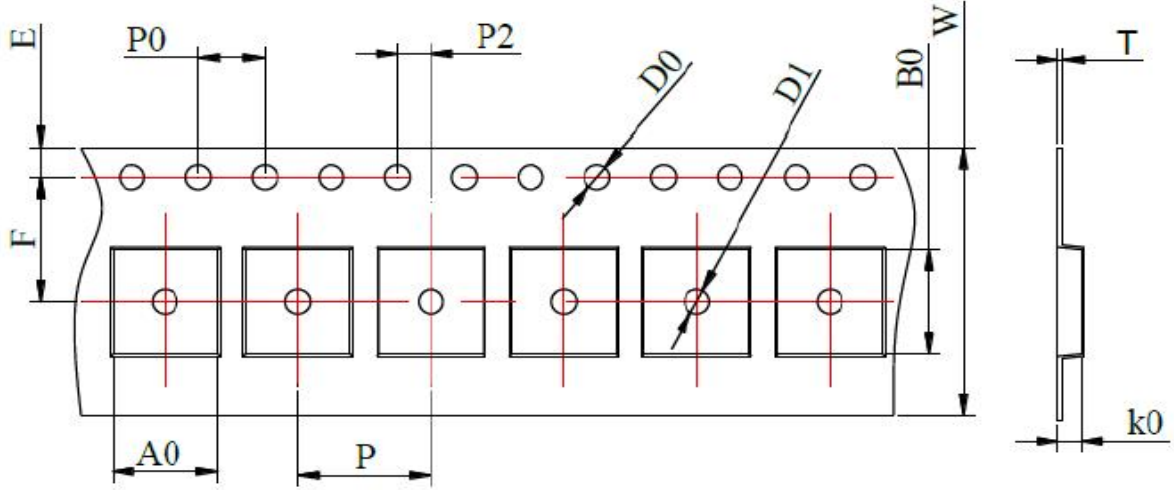

Type	Tape dimensions (mm)											
	W	P	P0	P2	D0	D1	T	A0	B0	K0	E	F
FXL0412	12 ±0.3	8 ±0.1	4 ±0.1	2 ±0.1	1.5 ±0.1	1.5 ±0.1	0.35 ±0.05	4.5 ±0.1	4.85 ±0.1	1.5 ±0.1	1.75 ±0.1	5.5 ±0.1
FXL0420	12 ±0.3	8 ±0.1	4 ±0.1	2 ±0.1	1.5 ±0.1	1.5 ±0.1	0.35 ±0.05	4.5 ±0.1	4.85 ±0.1	2.3 ±0.1	1.75 ±0.1	5.5 ±0.1
FXL0518	12 ±0.3	8 ±0.1	4 ±0.1	2 ±0.1	1.5 ±0.1	1.5 ±0.1	0.35 ±0.05	5.5 ±0.1	5.9 ±0.1	2.0 ±0.01	1.75 ±0.1	5.5 ±0.1
FXL0530	12 ±0.3	8 ±0.1	4 ±0.1	2 ±0.1	1.5 ±0.1	1.5 ±0.1	0.35 ±0.05	5.5 ±0.1	5.9 ±0.1	3.3 ±0.1	1.75 ±0.1	5.5 ±0.1
FXL0615	16 ±0.3	12 ±0.1	4 ±0.1	2 ±0.1	1.5 ±0.1	1.5 ±0.1	0.35 ±0.05	6.9 ±0.1	7.5 ±0.1	1.7 ±0.1	1.75 ±0.1	7.5 ±0.1
FXL0618	16 ±0.3	12 ±0.1	4 ±0.1	2 ±0.1	1.5 ±0.1	1.5 ±0.1	0.35 ±0.05	6.9 ±0.1	7.5 ±0.1	2.1 ±0.1	1.75 ±0.1	7.5 ±0.1
FXL0624	16 ±0.3	12 ±0.1	4 ±0.1	2 ±0.1	1.5 ±0.1	1.5 ±0.1	0.35 ±0.05	6.9 ±0.1	7.5 ±0.1	2.7 ±0.1	1.75 ±0.1	7.5 ±0.1
FXL0630	16 ±0.3	12 ±0.1	4 ±0.1	2 ±0.1	1.5 ±0.1	1.5 ±0.1	0.35 ±0.05	7.0 ±0.1	7.7 ±0.1	3.3 ±0.1	1.75 ±0.1	7.5 ±0.1
FXL0640	16 ±0.3	12 ±0.1	4 ±0.1	2 ±0.1	1.5 ±0.1	1.5 ±0.1	0.4 ±0.05	6.9 ±0.1	7.5 ±0.1	4.3 ±0.1	1.75 ±0.1	7.5 ±0.1
FXL0650	16 ±0.3	12 ±0.1	4 ±0.1	2 ±0.1	1.5 ±0.1	1.5 ±0.1	0.4 ±0.05	6.9 ±0.1	7.5 ±0.1	5.4 ±0.1	1.75 ±0.1	7.5 ±0.1
FXL0840	24 ±0.3	16 ±0.1	4 ±0.1	2 ±0.1	1.55 ±0.1	1.55 ±0.1	0.35 ±0.05	8.9 ±0.1	10.1 ±0.1	4.4 ±0.1	1.75 ±0.1	11.5 ±0.1
FXL1030	24 ±0.3	16 ±0.1	4 ±0.1	2 ±0.05	1.5 ±0.1	1.5 ±0.1	0.35 ±0.05	10.4 ±0.1	11.6 ±0.1	3.3 ±0.1	1.75 ±0.1	11.5 ±0.1
FXL1040	24 ±0.3	16 ±0.1	4 ±0.1	2 ±0.05	1.5 ±0.1	1.5 ±0.1	0.35 ±0.05	10.4 ±0.1	11.6 ±0.1	4.3 ±0.1	1.75 ±0.1	11.5 ±0.1
FXL1050	24 ±0.3	16 ±0.1	4 ±0.1	2 ±0.05	1.5 ±0.1	1.5 ±0.1	0.4 ±0.05	10.4 ±0.1	11.6 ±0.1	5.4 ±0.1	1.75 ±0.1	11.5 ±0.1
FXL1340	24 ±0.3	16 ±0.1	4.0 ±0.1	2.0 ±0.1	1.5 ±0.1	1.5 ±0.1	0.5 ±0.05	13.1 ±0.1	14 ±0.1	4.3 ±0.1	1.75 ±0.1	11.5 ±0.1

深圳市长江微电科技有限公司
SZ CJIANG TECHNOLOGY CO.,LTD

FXL1350	24 ±0.3	16 ±0.1	4.0 ±0.1	2.0 ±0.1	1.5 ±0.1	1.5 ±0.1	0.5 ±0.05	13.1 ±0.1	14 ±0.1	5.4 ±0.1	1.75 ±0.1	11.5 ±0.1
FXL1360	24 ±0.3	16 ±0.1	4.0 ±0.1	2.0 ±0.1	1.5 ±0.1	1.5 ±0.1	0.5 ±0.05	13.1 ±0.1	14 ±0.1	6.3 ±0.1	1.75 ±0.1	11.5 ±0.1
FXL1365	24 ±0.3	16 ±0.1	4.0 ±0.1	2.0 ±0.1	1.5 ±0.1	1.5 ±0.1	0.5 ±0.05	13.1 ±0.1	14 ±0.1	6.8 ±0.1	1.75 ±0.1	11.5 ±0.1
FXL1770	32 ±0.3	24 ±0.1	4.0 ±0.1	2.0 ±0.1	1.5 ±0.1	0.5 ±0.1	17.5 ±0.05	18.1 ±0.1	7.3 ±0.1	1.75 ±0.1	14.2 ±0.1	14.2 ±0.1
FXL2213	44 ±0.3	32 ±0.1	4.0 ±0.1	2.0 ±0.1	1.5 ±0.1	0.5 ±0.1	23 ±0.05	24.4 ±0.1	13.5 ±0.1	1.75 ±0.1	20.2 ±0.1	44 ±0.3

Taping Drawings (UNIT:mm)

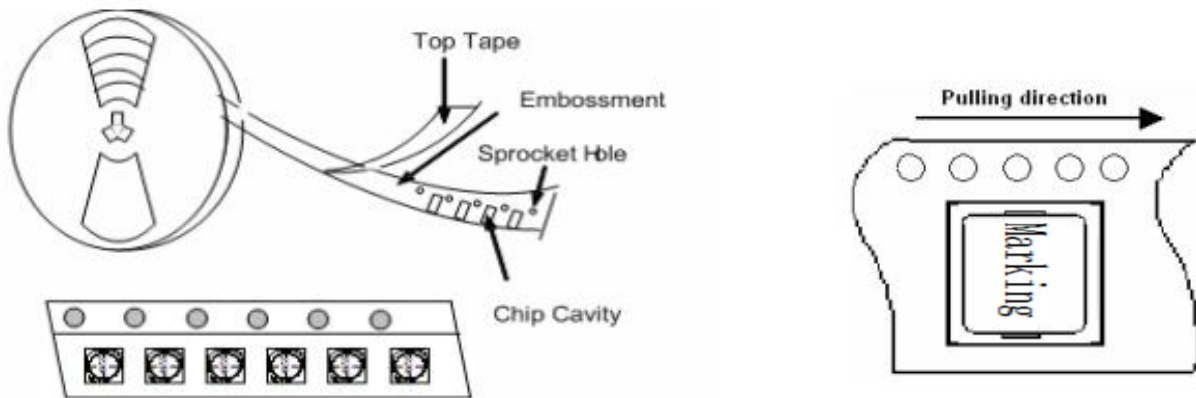

(2) Reel Dimensions (Unit: mm)

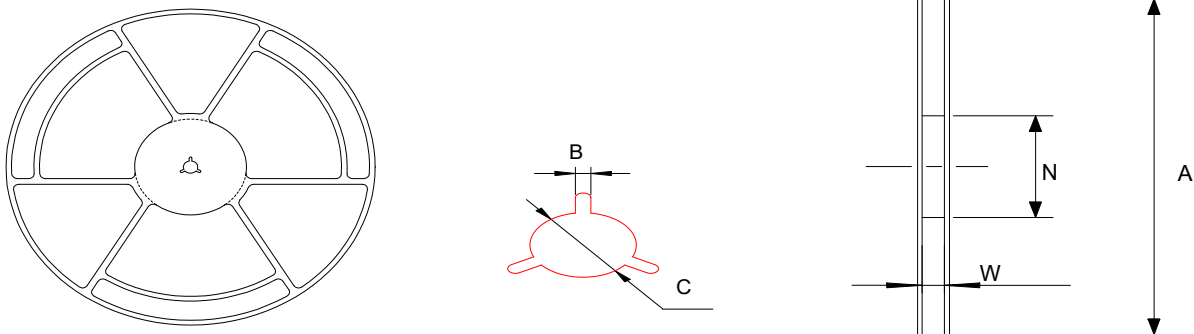

深圳市长江微电科技有限公司
SZ CJIANG TECHNOLOGY CO.,LTD

Type	A	W	N	B	C
FXL0412	330±2.0	12.8±0.2	97±0.5	2.2±0.5	13.0±0.2
FXL0420	330±2.0	12.8±0.2	97±0.5	2.2±0.5	13.0±0.2
FXL0518	330±2.0	12.8±0.2	97±0.5	2.2±0.5	13.2±0.2
FXL0530	330±2.0	12.8±0.2	97±0.5	2.2±0.5	13.2±0.2
FXL0615	330±2.0	16.8±0.2	97±0.5	2.2±0.5	13.2±0.2
FXL0618	330±2.0	16.8±0.2	97±0.5	2.2±0.5	13.2±0.2
FXL0624	330±2.0	16.8±0.2	97±0.5	2.2±0.5	13.2±0.2
FXL0630	330±2.0	16.8±0.2	97±0.5	2.2±0.5	13.2±0.2
FXL0640	330±2.0	16.8±0.2	97±0.5	2.2±0.5	13.2±0.2
FXL0650	330±2.0	16.8±0.2	97±0.5	2.2±0.5	13.2±0.2
FXL0840	330±2.0	24±0.5	97±0.5	2.2±0.5	13.0±0.2
FXL1030	330±2.0	24±0.5	97±0.5	2.2±0.5	13.0±0.2
FXL1040	330±2.0	24±0.5	97±0.5	2.2±0.5	13.0±0.2
FXL1050	330±2.0	24±0.5	97±0.5	2.2±0.5	13.0±0.2
FXL1340	330±2.0	24±0.5	97±0.5	2.2±0.5	13.0±0.2
FXL1350	330±2.0	24±0.5	97±0.5	2.2±0.5	13.0±0.2
FXL1360	330±2.0	24±0.5	97±0.5	2.2±0.5	13.0±0.2
FXL1365	330±2.0	24±0.5	97±0.5	2.2±0.5	13.0±0.2

深圳市长江微电科技有限公司
SZ CJIANG TECHNOLOGY CO.,LTD

FXL1770	330±2.0	32.0±0.5	97±0.5	2.3±0.3	13.0±0.2
FXL2213	330±2.0	44.0±0.5	97±0.5	2.3±0.3	13.0±0.2

深圳市长江微电科技有限公司
SZ CJIANG TECHNOLOGY CO.,LTD

(3) Packaging Quantity

Type	Standard Quantity		
	Reel	Inner box	Carton box
FXL0412	3000 pcs / reel	4Reel / box (12000 pcs)	3 Middle boxes, (36,000 pcs)
FXL0420	3000 pcs / reel	4Reel / box (12000 pcs)	3 Middle boxes, (36,000 pcs)
FXL0518	2000 pcs / reel	4Reel / box (8000 pcs)	3 Middle boxes, (24000 pcs)
FXL0530	2000 pcs / reel	4Reel / box (8000 pcs)	3 Middle boxes, (24000 pcs)
FXL0615	2000 pcs / reel	3Reel / box (6000 pcs)	3 Middle boxes, (18000 pcs)
FXL0618	1500 pcs / reel	3Reel / box (4500 pcs)	3 Middle boxes, (13500 pcs)
FXL0624	1500 pcs / reel	3Reel / box (4500 pcs)	3 Middle boxes, (13500 pcs)
FXL0630	1500 pcs / reel	3Reel / box (4500 pcs)	3 Middle boxes, (13500 pcs)
FXL0640	1000 pcs / reel	3Reel / box (3000 pcs)	3 Middle boxes, (9000 pcs)
FXL0650	1000 pcs / reel	3Reel / box (3000 pcs)	3 Middle boxes, (9000 pcs)
FXL0840	800 pcs / reel	2Reel / box (1600 pcs)	3 Middle boxes, (4800 pcs)
FXL1030	800 pcs / reel	2Reel / box (1600 pcs)	3Middle boxes, (4800 pcs)
FXL1040	500 pcs / reel	2Reel / box (1000 pcs)	3 Middle boxes, (3000 pcs)
FXL1050	500 pcs / reel	2Reel / box (1000 pcs)	3 Middle boxes, (3000 pcs)
FXL1340	500 pcs / reel	2Reel / box (1000 pcs)	3 Middle boxes, (3000 pcs)
FXL1350	500 pcs / reel	2Reel / box (1000 pcs)	3 Middle boxes, (3000 pcs)
FXL1360	500 pcs / reel	2Reel / box (1000 pcs)	3 Middle boxes, (3000 pcs)

深圳市长江微电科技有限公司
SZ CJIANG TECHNOLOGY CO.,LTD

FXL1365	500 pcs / reel	2Reel / box (1000 pcs)	3 Middle boxes, (3000 pcs)
FXL1770	200 pcs / reel	2Reel / box (400 pcs)	3 Middle boxes, (12000 pcs)
FXL2213	80 pcs / reel	1Reel / box (80 pcs)	Middle boxes, (240 pcs)

(4) Peel force of top cover tape

The peel speed shall be about 300mm/minute

The peel force of top cover tape shall be between 0.1 to 1.3 N

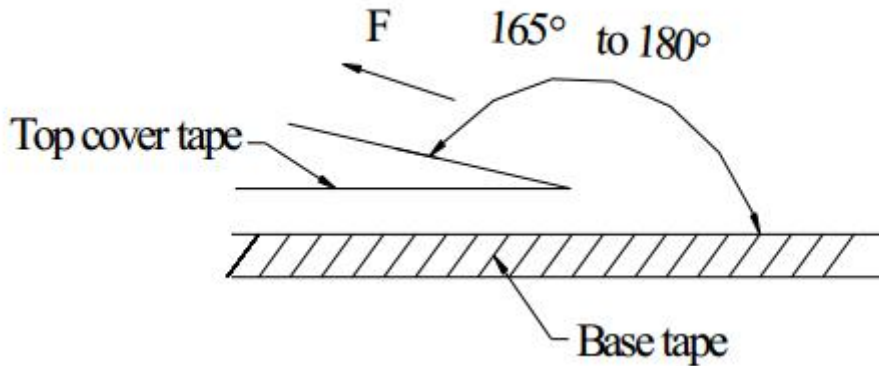

(5) Reel Label

Label on the reel

- Customer's part Number
- Lot Number
- Quantity
- date code

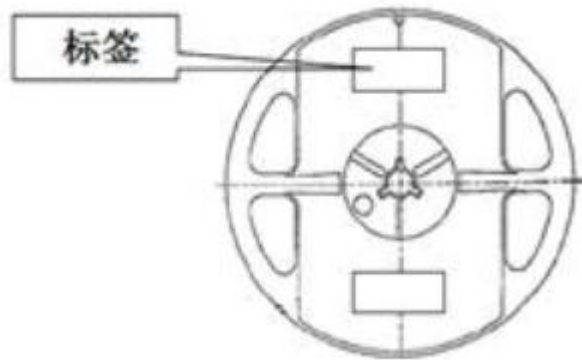

Shipping Label

- Customer's part Number
- Manufacturer's part Number
- Quantity
- date code

(6) Inner Box

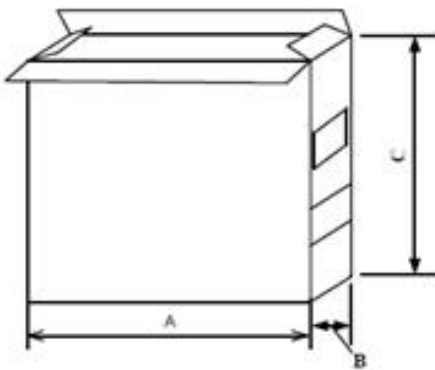

Packaging type	A (mm)	B (mm)	B (mm)
inner box	354	335	86

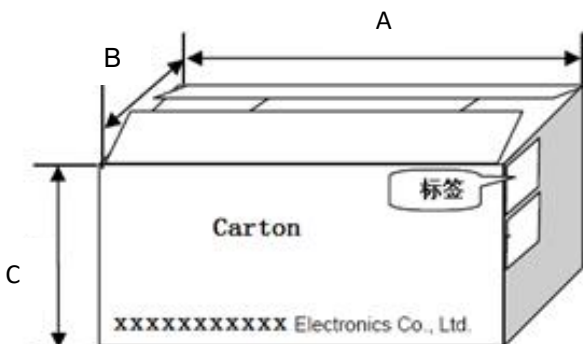

Packaging type	A (mm)	B (mm)	B (mm)
type	370	365	285

X-ON Electronics

Largest Supplier of Electrical and Electronic Components

Click to view similar products for [Fixed Inductors](#) category:

Click to view products by [Changjiang Microelectronics](#) manufacturer:

Other Similar products are found below :

[CR32NP-100KC](#) [70F224AI](#) [MHQ1005P10NJ](#) [MHQ1005P1N0S](#) [MHQ1005P2N4S](#) [MHQ1005P3N6S](#) [MHQ1005P5N1S](#) [MHQ1005P8N2J](#)
[PE-53601NL](#) [PE-53602NL](#) [PG0936.113NLT](#) [9220-20](#) [9310-16](#) [PM06-2N7](#) [PM06-39NJ](#) [A01TK](#) [1206CS-471XJ](#) [HC2-R47-R](#) [HC8-1R2-R](#)
[HCF1305-3R3-R](#) [1206CS-151XG](#) [RCH664NP-4R7M](#) [RCP1317NP-391L](#) [DH2280-4R7M](#) [DS1608C-106](#) [B10TJ](#) [B82498B3101J000](#) [ELJ-](#)
[RE27NJF2](#) [1812CS-153XJ](#) [1812CS-183XJ](#) [1812CS-223XJ](#) [1812LS-104XJ](#) [1812LS-105XJ](#) [1812LS-124XJ](#) [1812LS-154XJ](#) [1812LS-223XJ](#)
[1812LS-224XJ](#) [1812LS-563XJ](#) [1812LS-683XJ](#) [1812LS-824XJ](#) [NIN-FB101JTR110F](#) [NIN-FB471JTR62F](#) [NIN-FC1R5JTR220F](#) [NIN-](#)
[HCR15JTRF](#) [NIN-HCR33JTRF](#) [NIN-HDR22JTRF](#) [NIN-HDR82JTRF](#) [NIN-HK2N7STRF](#) [NIN-PA150KTR370F](#) [NIN-PB100KTR550F](#)