

Specification for Approval

Customer	
Product Name	Wire Wound Molded SMD Power Inductors
Customer P/N:	
Cjiang P/N:	SPM2510 Series

[New Released, Revised]

SPEC No.:

REMARK:		
Customer Approval Feedback		

● 深圳市长江微电科技有限公司

SZ CJIANG TECHNOLOGY CO.,LTD

ADD: 11F, International Science and Technology Building, Fuhong Road, Futian District, Shenzhen

Factory ADD:No. shanyang RD CJIANG Industrial Park HUAI'AN Section HUAI'AN City Jiangsu Province

TEL: 0755-82529562 FAX:0755-83977004

<http://www.CJING.COM.CN>

E-mail: BOND@cjiang.com.cn; ann@cjiang.com.cn

Version change history

Rev	Date	Description	APPROVED	CHECKED	DRAWN
1.0	2022/8/9	文件制定	Bond	Charles	王云燕

Caution :

All products listed in this specification are developed, designed and intended for use in general electronics equipment. The products are not designed or Warranted to meet the requirements of the applications listed below, whose performance and/or quality require especially high reliability, or whose failure, malfunction or trouble might directly cause damage to society, person, or property. Please understand that we are not responsible for any damage or liability caused by use of the products in any of the applications below. Please contact us for more details if you intend to use our products in the following applications.

1. Aircraft equipment.
2. Aerospace equipment.
3. Undersea equipment.
4. nuclear control equipment.
5. military equipment.
6. Power plant equipment.
7. Medical equipment.
8. Transportation equipment (automobiles, trains, ships,etc.)
9. Traffic signal equipment.
10. Disaster prevention / crime prevention equipment.
11. Data-processing equipment.
12. Applications of similar complexity or with reliability requirements comparable to the applications listed in the above.

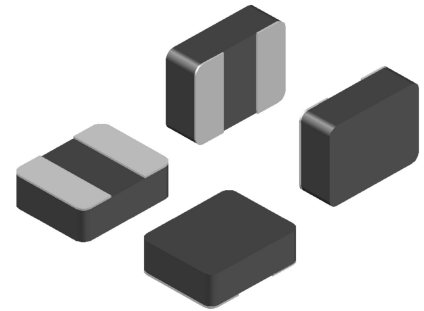

1. Scope

Features

- 1.1 Metal material for large current and low loss.
- 1.2 High performance (Isat) realized by metal dust core.
- 1.3 Low loss realized with low Rdc.
- 1.4 Closed magnetic circuit design reduces leakage flux.
- 1.5 Vinyl thermal spray, better surface compactness.
- 1.6 100% lead (Pb) free meet RoHS standard.

2. Application

- 2.1 DC/DC converters.
- 2.2 Pad,Smart phone.
- 2.3 Portable gaming devices, Smart wear, Wi-Fi module.
- 2.4 Notebooks, VR, AR.
- 2.5 LCD displays, HDDs, DVCs, DSCs, etc.
- 2.6 Baseband power supply, Amplifier, Power management, Module power supply, Camera power manageme.

3. Ordering Procedure

SPM 2510 - 1R0 M A
① ② ③ ④ ⑤

①Series Name: Mini Molding Power Inductors

②External Dimensions(L×W):2016=2.0*1.6 mm

③Inductance value:1R0=1.0uH

④Tolerance:K=±10% M=±20% N=±30%

⑤Special define:A=Routine B~Z=Special

For special characteristics, please refer to the specific values in Item 5 "Specifications".

4. SHAPE AND DIMENSIONS

Outline Dimensions

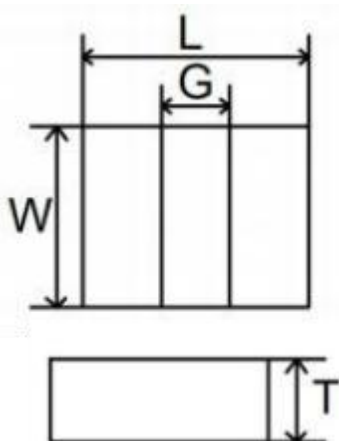

Recommend Land Pattern Dimensions

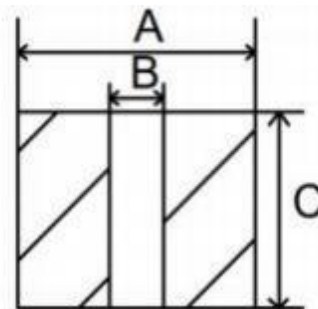

Units: mm

Series	L	G (TYP)	W	T	A	B	C
SPM2510	2.5±0.2	0.7	2.0±0.2	1.00Max.	2.60	0.70	2.10

5. Marking

SPM2510(2.5*2.0*1.0mm)

P/N	L0(μ H) @ (0A) 1MHz	Rdc(m Ω)		Heat rating current Irms(A)		Saturation current Isat(A)	
		Typical	Max	Typical	Max	Typical	Max
SPM2510-R22MA	0.22	12	17	6.8	6.5	8.6	7.9
SPM2510-R24MA	0.24	12	17.5	6.7	6.4	8.5	7.8
SPM2510-R33MA	0.33	13	19	6.5	6.2	7.6	7.2
SPM2510-R47MA	0.47	15	22	6.1	5.6	7.0	6.5
SPM2510-R68MA	0.68	23	27	5.6	5.0	5.9	5.5
SPM2510-1R0MA	1.0	22.5	30	5.4	4.1	5.3	4.8
SPM2510-1R5MA	1.5	45	55	3.4	3.0	4.3	3.9
SPM2510-2R2MA	2.2	60.5	70	2.5	2.1	3.5	3.0
SPM2510-3R3MA	3.3	86	100	2.5	2.1	2.8	2.5
SPM2510-4R7MA	4.7	160	180	2.0	1.6	2.6	2.0
SPM2510-4R7MD	4.7	145	160	2.0	1.6	2.6	2.0
SPM2510-6R8MA	6.8	270	320	1.6	1.4	2.4	1.9
SPM2510-100MA	10.0	500	560	1.05	0.95	1.55	1.4
SPM2510-220MA	22.0	1100	1300	0.85	0.6	1.1	0.9

Test remarks

Note 1.: All test data is referenced to 25 °C ambient.

Note 2.: Test Condition:1MHz, 1.0Vrms.

Note 3.: Irms:DC current (A) that will cause an approximate ΔT of 40 °C.

Note 4.: Isat:DC current (A) that will cause L0 to drop approximately 30%.

Note 5.: Operating Temperature Range -55°C to + 125°C.

Note 6.: The part temperature (ambient + temp rise) should not exceed 125 under °C the worst case operating conditions. Circuit design,

Note 7.: The rated current as listed is either the saturation current or the heating current depending on which value is lower.

Note 8 : For SPM series inductors,absolute maximum voltage: DC 20V

6. Structure

component placement, PCB trace size and thickness, airflow and other cooling provision all affect the part temperature. Part temperature should be verified in the end application.

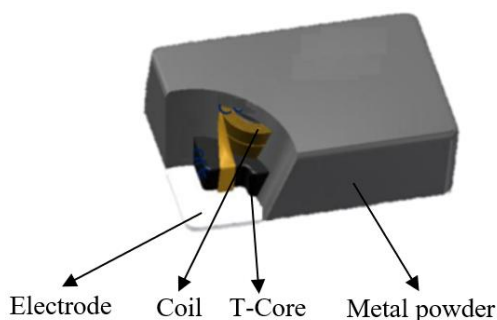

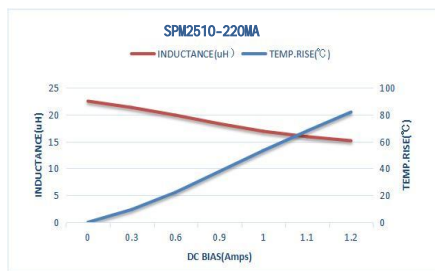
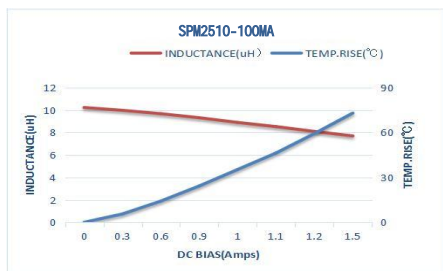
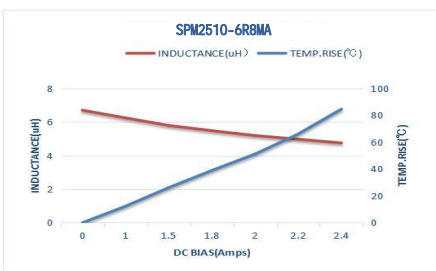
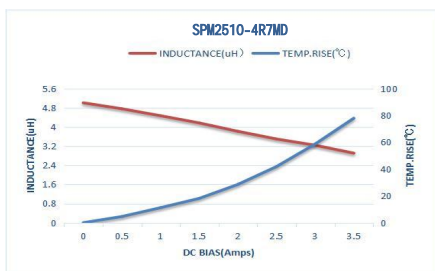
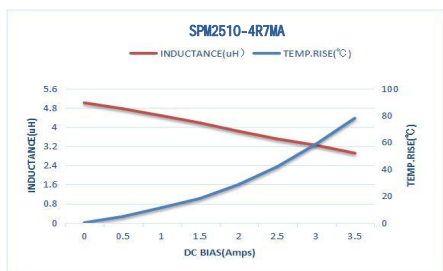
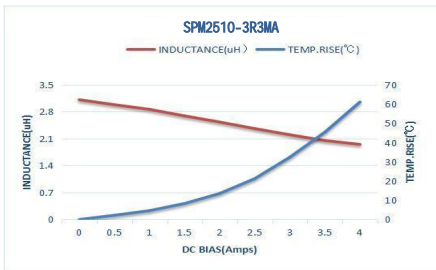
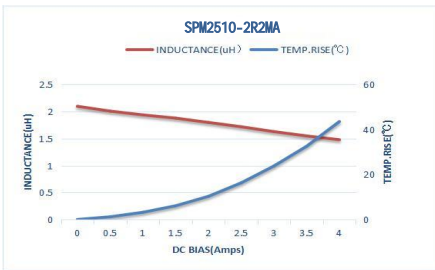
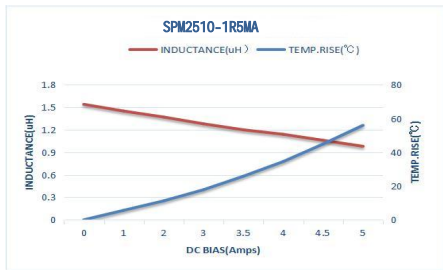
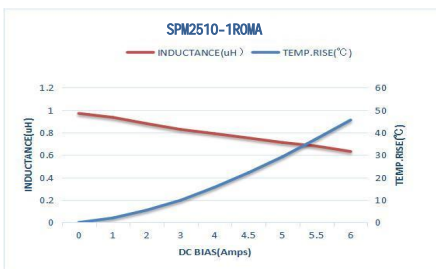
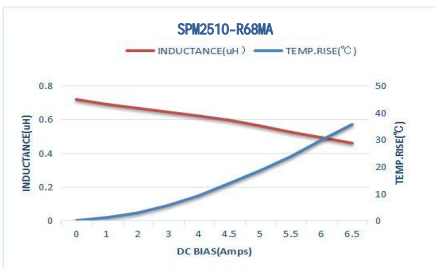
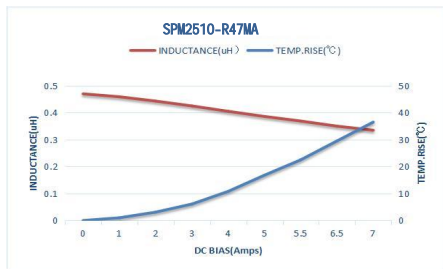
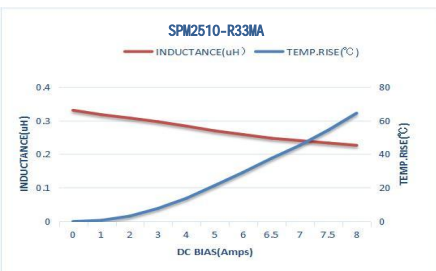
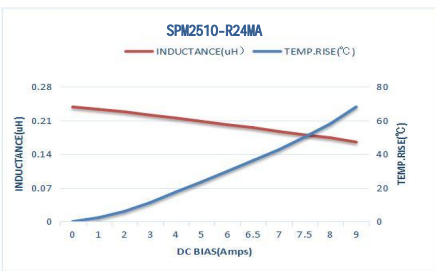
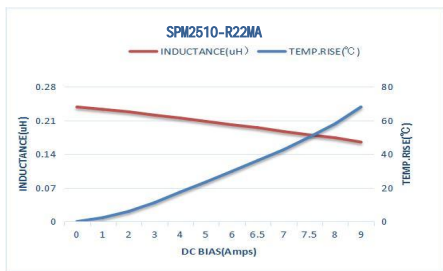

7. Reliability

Item	Requirements	Test Methods and Remarks
Insulation Resistance	≥100MΩ	100 VDC between inductor coil and The middle of the top surface of the body for 60 seconds.
Solderability	90% or more of electrode area shall be coated by new solde.	Dip pads in flux . Solder Composition: Sn/Ag3.0/Cu0.5(Pb-Free). Solder Temperature: 245±5℃. Immersion Time: (5±1) s.
Resistance to Soldering Heat	No visible mechanical damage. Inductance change: Within ±10.	Dip pads in flux. Solder Composition: Sn/Ag3.0/Cu0.5(Pb-Free). Solder Temperature: 260±5℃. Immersion Time: 10±1sec.
Adhesion of teral electrode	Strong bond between the pad and the core, without come off PCB.	Inductors shall be subjected to (260±5)°C for (20±5)s Soldering in the base whit 0.3mm solder. And then aplombelectrode way plus tax 10 N for (10±1) seconds.
High temperature	No case deformation or change in appearance. Inductance change: Within ±10%	Temperature: 125±2℃. Time : 1000 hours. Measurement at 24±4 hours after test conclusion.
Low temperature	No visible mechanical damage. Inductance change: Within ±10%	Temperature: -40±2℃. Time : 1000 hours. Measurement at 24±4 hours after test conclusion.
Thermal shock	No visible mechanical damage. Inductance change: Within ±10%	The test sample shall be placed at (-55±3)°C and (125±3)°C for (30±3) , different temperature conversion time is 2~3 utes. The temperature cycle shall be repeated 32 cycles. Placed at room temperature for 2 hours, within 48±4 hours of testing.
Temperature characteristic	Inductance change Pc-b,Pc-d: Within ±20%	a: +20 °C (30~45) → b: -40 °C (30~45) → c: +20 °C (30~45) → d: +125 °C (30~45) → e: +20 °C (30~45) $P_{c-b} = \frac{L_b - L_c}{L_c} \times 100\% \quad ; \quad P_{c-d} = \frac{L_d - L_c}{L_c} \times 100\%$
Static Humidity	No visible mechanical damage. Inductance change: Within ±10%	Inductors shall be subjected to (95±3)%RH . at(60±2)°C for (1000±4) h. Placed at room temperature for 2 hours, within 48 hours of testing.
Life	No visible mechanical damage. Inductance change: Within ±10%	Inductors shall be store at (85±2)°C for (1000±4) hours with Irms applied. Placed at room temperature for 2 hours, within 48 hours of testing

8. Soldering Condition

(This is for recommendation, please customer perform adjustment according to actual application)

Recommend Reflow Soldering Profile : (solder : Sn96.5 / Ag3 / Cu0.5)

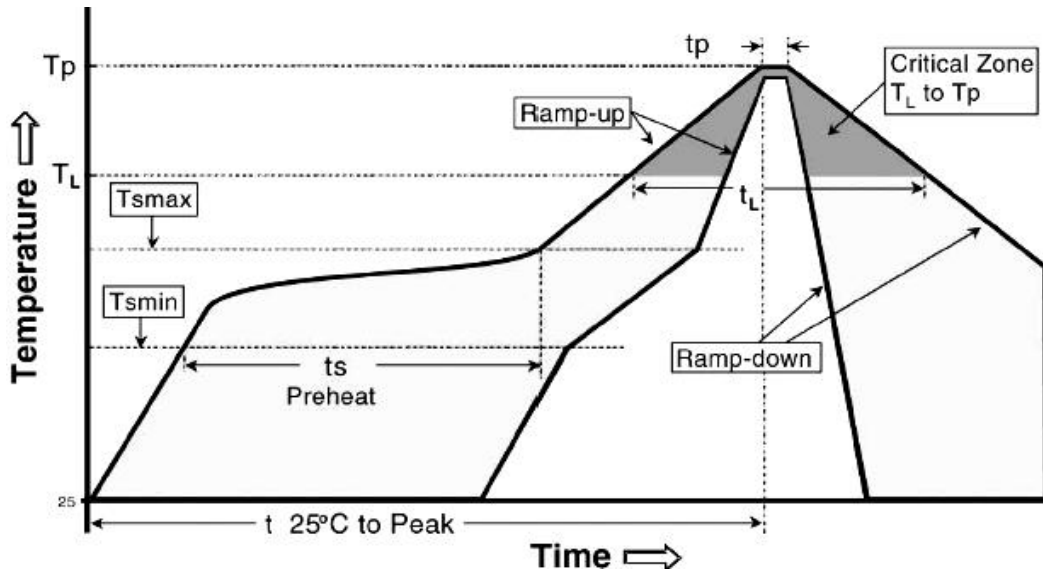

Profile Feature	Lead (Pb)-Free solder
Preheat:	
Temperature Min (T _{min})	150°C
Temperature Max (T _{max})	200°C
Time (T _{min} to T _{max}) (t _s)	60 -120 seconds
Average ramp-up rate:	
(T _{s max} to T _p)	3°C / second max.
Time maintained above :	
Temperature (T _L)	217°C
Time (t _L)	60-150 seconds
Peak Temperature (T _p)	260°C
Time within $\begin{matrix} +0^{\circ}\text{C} \\ -5 \end{matrix}$ of actual peak Temperature (t _p) ²	10 seconds
Ramp-down Rate	6°C/second max.
Time 25°C to Peak Temperature	8minutes max.

Allowed Re-flow times : 2 times

Remark : To avoid discoloration phenomena of chip on terminal electrodes, please use N₂ Re-flow furnace .

9. Packing

9.1 Dimension of plastic taping: (Unit: mm)

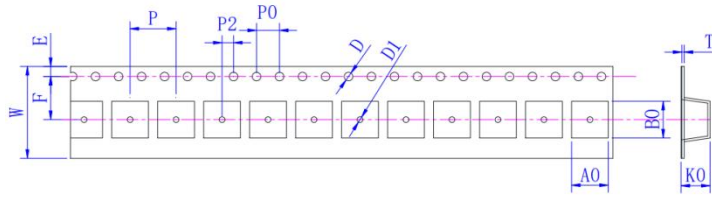

Series	W ±0.30	A0 ±0.05	B0 +0.1/-0	D +0.1/-0	D1 Min	E ±0.10	F ±0.10	K0 ±0.05	P0 ±0.10	P2 ±0.10	P ±0.10	T ±0.05	Qty/Reel
2510	8.0	2.40	2.80	1.50	1.0	1.75	3.50	1.20	4.00	2.00	4.00	0.23	3K

9.2 Dimension of Reel : (Unit: mm)

Type	A ±0.5	B ±0.5	C ±0.5	D ±1
All	178	60	12	1.5

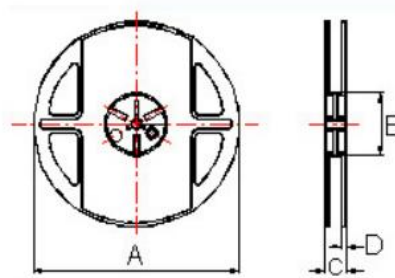

10. Note

10.1 recommend products store in warehouse with temperature between 15 to 35°C under humidity between 25 to 75%RH.

Even under storage conditions recommended above, solder ability of products will be degraded stored over 1 year old.

10.2 Cartons must be placed in correct direction which indicated on carton, .otherwise the reel or wire will be deformed

10.3 Storage conditions as below are inappropriate:

- a. Stored in high electrostatic environment
- b. Stored in direct sunshine, rain, snow or condensation.
- c. Exposed to sea wind or corrosive gases, such as Cl₂, H₂S, NH₃, SO₂, NO₂, etc.

10.4 The products are used in circuit board thickness greater than 1.6mm. If customers use less than the thickness of the circuit board that you should confirm with the company, in order to recommend a more suitable product.

11. Record

Version	Description	Page	Date	Amended by	Checked by
A0	First version	1~23	Nov.21.2022	Xi Rui.Niu	Dirk.Wang
A1	newly increased : SPM2510-6R8MA SPM2510-220MA	1~23	Dec.14.2022	Xi Rui.Niu	Dirk.Wang

X-ON Electronics

Largest Supplier of Electrical and Electronic Components

Click to view similar products for [Fixed Inductors](#) category:

Click to view products by [Changjiang Microelectronics](#) manufacturer:

Other Similar products are found below :

[CR32NP-100KC](#) [70F224AI](#) [MHQ1005P10NJ](#) [MHQ1005P1N0S](#) [MHQ1005P2N4S](#) [MHQ1005P3N6S](#) [MHQ1005P5N1S](#) [MHQ1005P8N2J](#)
[PE-53601NL](#) [PE-53602NL](#) [PG0936.113NLT](#) [9220-20](#) [9310-16](#) [PM06-2N7](#) [PM06-39NJ](#) [A01TK](#) [1206CS-471XJ](#) [HC2-R47-R](#) [HC8-1R2-R](#)
[HCF1305-3R3-R](#) [1206CS-151XG](#) [RCH664NP-4R7M](#) [RCP1317NP-391L](#) [DH2280-4R7M](#) [DS1608C-106](#) [B10TJ](#) [B82498B3101J000](#) [ELJ-](#)
[RE27NJF2](#) [1812CS-153XJ](#) [1812CS-183XJ](#) [1812CS-223XJ](#) [1812LS-104XJ](#) [1812LS-105XJ](#) [1812LS-124XJ](#) [1812LS-154XJ](#) [1812LS-223XJ](#)
[1812LS-224XJ](#) [1812LS-563XJ](#) [1812LS-683XJ](#) [1812LS-824XJ](#) [NIN-FB101JTR110F](#) [NIN-FB471JTR62F](#) [NIN-FC1R5JTR220F](#) [NIN-](#)
[HCR15JTRF](#) [NIN-HCR33JTRF](#) [NIN-HDR22JTRF](#) [NIN-HDR82JTRF](#) [NIN-HK2N7STRF](#) [NIN-PA150KTR370F](#) [NIN-PB100KTR550F](#)