

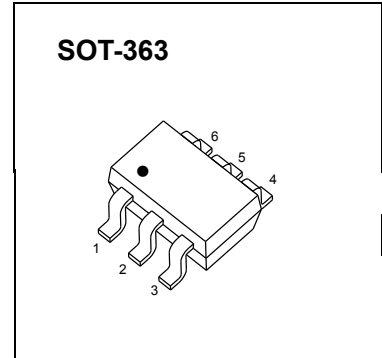

**SOT-363 Plastic-Encapsulate MOSFETs**

**2N7002DW** Dual N-channel MOSFET

$V_{(BR)DSS}$	$R_{DS(on)MAX}$	$I_D$
60V	5Ω@10V	115mA
	7Ω@5V	



**FEATURE**

- High density cell design for low  $R_{DS(ON)}$
- Voltage controlled small signal switch
- Rugged and reliable
- High saturation current capability

**APPLICATION**

- Load Switch for Portable Devices
- DC/DC Converter

**MARKING**

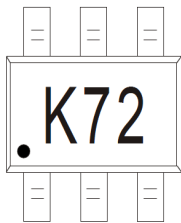

**Equivalent Circuit**

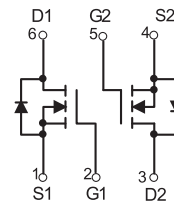

**MAXIMUM RATINGS ( $T_a=25^{\circ}C$  unless otherwise noted)**

Symbol	Parameter	Value	Unit
$V_{DS}$	Drain-Source voltage	60	V
$V_{GS}$	Gate-Source voltage	±20	V
$I_D$	Drain Current	115	mA
$P_D$	Power Dissipation	150	mW
$R_{\theta JA}$	Thermal Resistance from Junction to Ambient	833	°C/W
$T_J$	Junction Temperature	150	°C
$T_{stg}$	Storage Temperature	-55-150	°C

## MOSFET ELECTRICAL CHARACTERISTICS

$T_a=25^\circ\text{C}$  unless otherwise specified

Parameter	Symbol	Test conditions	Min	Typ	Max	Unit
Drain-source breakdown voltage	$V_{(BR)DSS}$	$V_{GS}=0\text{ V}, I_D=250\ \mu\text{A}$	60			V
Gate-threshold voltage *	$V_{th(GS)}$	$V_{DS}=V_{GS}, I_D=250\ \mu\text{A}$	1	1.6	2.5	
Gate-body leakage	$I_{GSS}$	$V_{DS}=0\text{ V}, V_{GS}=\pm 20\text{ V}$			$\pm 80$	nA
Zero gate voltage drain current	$I_{DSS}$	$V_{DS}=60\text{ V}, V_{GS}=0\text{ V}$			80	nA
Drain-source on-resistance *	$R_{DS(on)}$	$V_{GS}=10\text{ V}, I_D=500\text{mA}$		1.1	5	$\Omega$
		$V_{GS}=5\text{ V}, I_D=50\text{mA}$		1.2	7	
Forward transconductance *	$g_{fs}$	$V_{DS}=10\text{ V}, I_D=200\text{mA}$	80			ms
Drain-source on-voltage *	$V_{DS(on)}$	$V_{GS}=10\text{V}, I_D=500\text{mA}$			3.75	V
		$V_{GS}=5\text{V}, I_D=50\text{mA}$			0.375	V
Diode forward voltage	$V_{SD}$	$I_S=115\text{mA}, V_{GS}=0\text{ V}$	0.55		1.2	V
Input capacitance **	$C_{iss}$	$V_{DS}=25\text{V}, V_{GS}=0\text{V}, f=1\text{MHz}$			50	pF
Output capacitance **	$C_{oss}$				25	
Reverse transfer capacitance **	$C_{rss}$				5	

### SWITCHING TIME

Turn-on time **	$t_{d(on)}$	$V_{DD}=25\text{ V}, R_L=50\ \Omega$			20	ns
Turn-off time **	$t_{d(off)}$	$I_D=500\text{mA}, V_{GEN}=10\text{V}, G=25\ \Omega$			40	

\* Pulse Test: Pulse width  $\leq 300\ \mu\text{s}$ , duty cycle  $\leq 2\%$ .

\*\* These parameters have no way to verify.

# Typical Characteristics

Output Characteristics

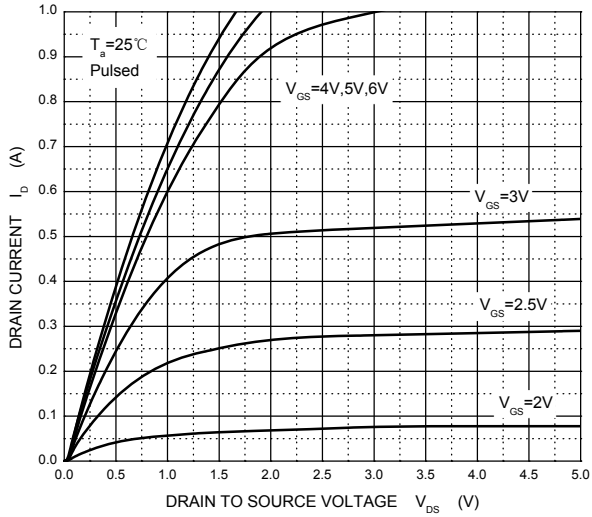

Transfer Characteristics

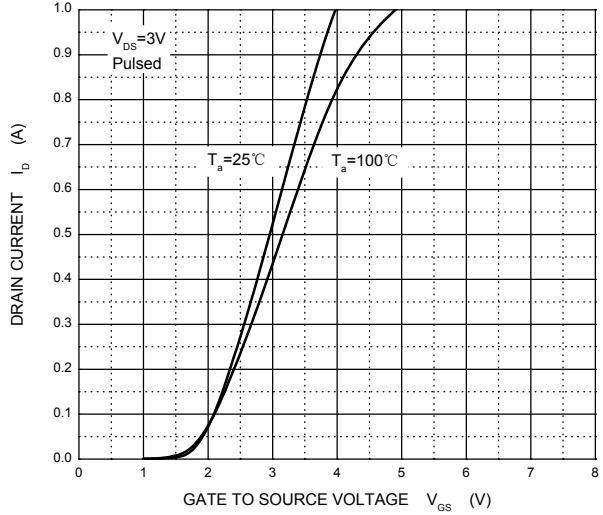

$R_{DS(ON)}$  —  $I_D$

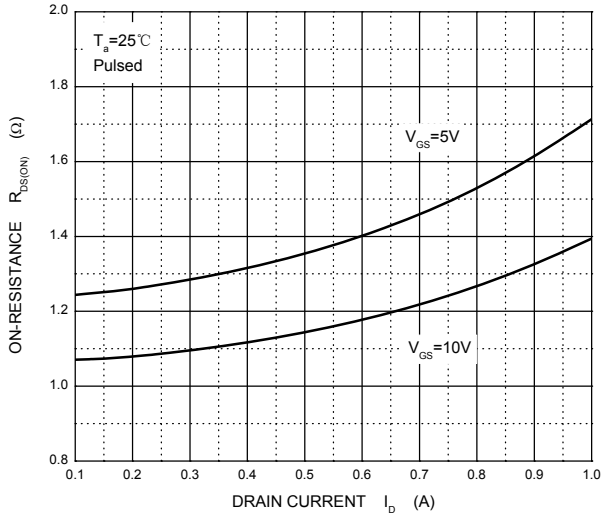

$R_{DS(ON)}$  —  $V_{GS}$

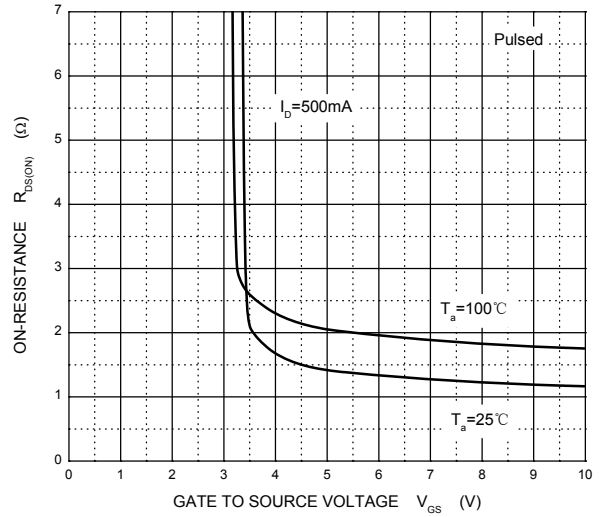

$I_S$  —  $V_{SD}$

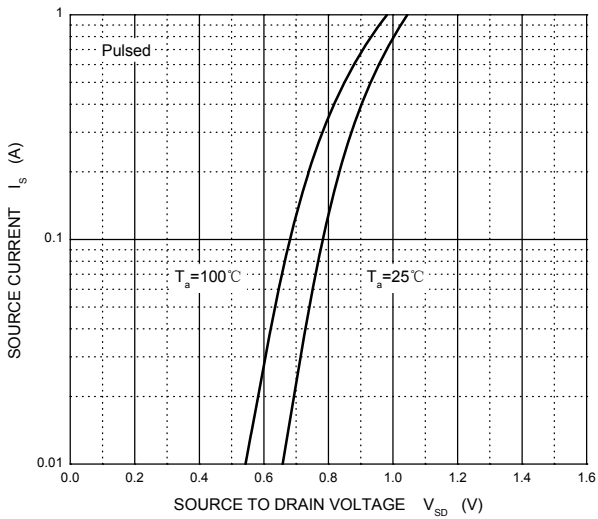

Threshold Voltage

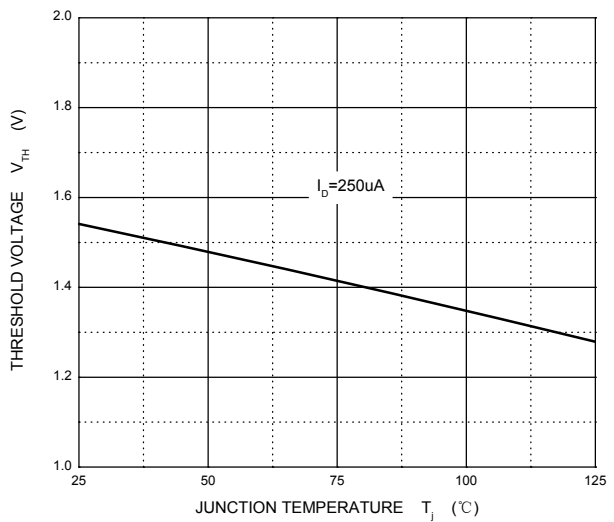

## SOT-363 Package Outline Dimensions

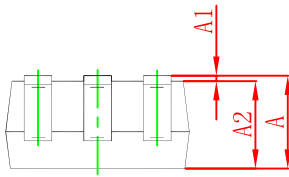
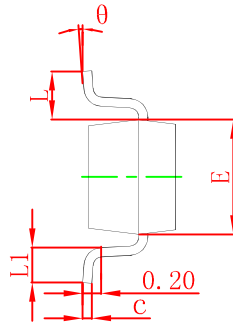
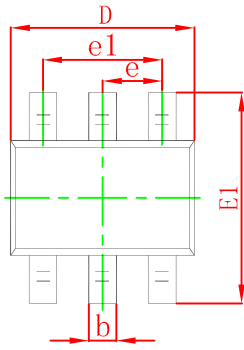

Symbol	Dimensions In Millimeters		Dimensions In Inches	
	Min	Max	Min	Max
A	0.900	1.100	0.035	0.043
A1	0.000	0.100	0.000	0.004
A2	0.900	1.000	0.035	0.039
b	0.150	0.350	0.006	0.014
c	0.100	0.150	0.004	0.006
D	2.000	2.200	0.079	0.087
E	1.150	1.350	0.045	0.053
E1	2.150	2.400	0.085	0.094
e	0.650 TYP		0.026 TYP	
e1	1.200	1.400	0.047	0.055
L	0.525 REF		0.021 REF	
L1	0.260	0.460	0.010	0.018
theta	0°	8°	0°	8°

## SOT-363 Suggested Pad Layout

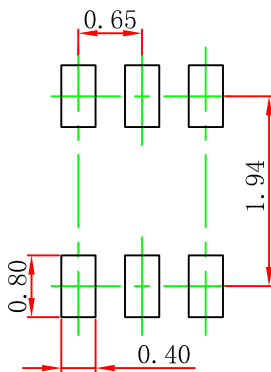

Note:

1. Controlling dimension: in millimeters.
2. General tolerance:  $\pm 0.05\text{mm}$ .
3. The pad layout is for reference purposes only.

### NOTICE

JSCJ reserve the right to make modifications, enhancements, improvements, corrections or other changes without further notice to any product herein. JSCJ does not assume any liability arising out of the application or use of any product described herein.

# SOT-363 Tape and reel

## SOT-363 Embossed Carrier Tape

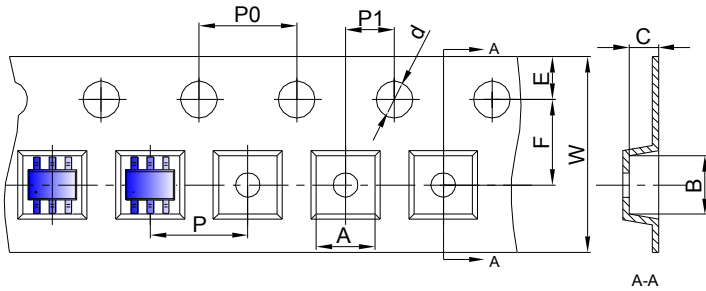

**Packaging Description:**  
 SOT-363 parts are shipped in tape. The carrier tape is made from a dissipative (carbon filled) polycarbonate resin. The cover tape is a multilayer film (Heat Activated Adhesive in nature) primarily composed of polyester film, adhesive layer, sealant, and anti-static sprayed agent. These reeled parts in standard option are shipped with 3,000 units per 7" or 17.8cm diameter reel. The reels are clear in color and is made of polystyrene plastic (anti-static coated).

Dimensions are in millimeter										
Pkg type	A	B	C	d	E	F	P0	P	P1	W
SOT-363	2.25	2.55	1.20	Ø1.50	1.75	3.50	4.00	4.00	2.00	8.00

## SOT-363 Tape Leader and Trailer

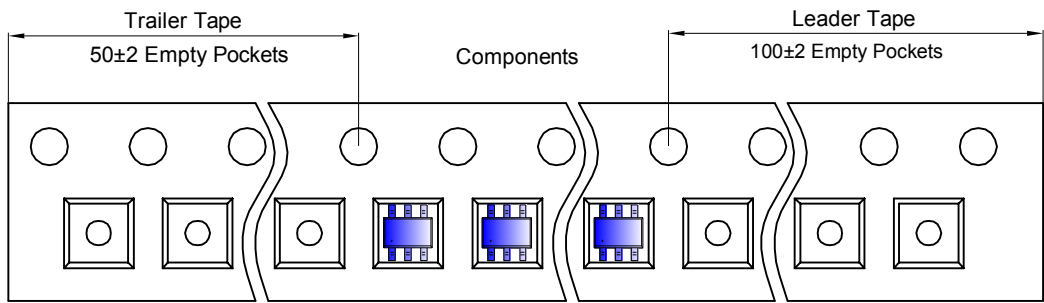

## SOT-363 Reel

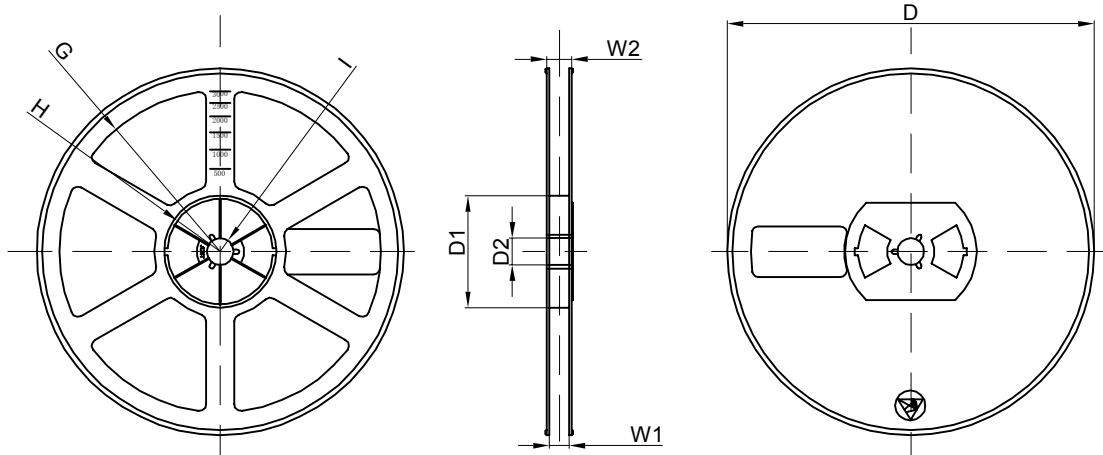

Dimensions are in millimeter								
Reel Option	D	D1	D2	G	H	I	W1	W2
7" Dia	Ø178.00	54.40	13.00	R78.00	R25.60	R6.50	9.50	12.30

REEL	Reel Size	Box	Box Size(mm)	Carton	Carton Size(mm)	G.W.(kg)
3000 pcs	7 inch	30,000 pcs	203×203×195	120,000 pcs	438×438×220	

## X-ON Electronics

Largest Supplier of Electrical and Electronic Components

*Click to view similar products for [MOSFET](#) category:*

*Click to view products by [Changjing Electronics Technology](#) manufacturer:*

Other Similar products are found below :

[614233C](#) [648584F](#) [IRFD120](#) [IRFF430](#) [JANTX2N5237](#) [2N7000](#) [FCA20N60\\_F109](#) [FDZ595PZ](#) [AOD464](#) [2SK2267\(Q\)](#) [2SK2545\(Q,T\)](#)  
[405094E](#) [423220D](#) [MIC4420CM-TR](#) [VN1206L](#) [614234A](#) [715780A](#) [SSM6J414TU,LF\(T](#) [751625C](#) [BSC884N03MS G](#) [BSF024N03LT3 G](#)  
[PSMN4R2-30MLD](#) [TK31J60W5,S1VQ\(O](#) [2SK2614\(TE16L1,Q\)](#) [DMN1017UCP3-7](#) [EFC2J004NUZTDG](#) [FCAB21350L1](#) [P85W28HP2F-](#)  
[7071](#) [DMN1053UCP4-7](#) [NTE2384](#) [NTE2969](#) [NTE6400A](#) [DMN2080UCB4-7](#) [DMN61D9UWQ-13](#) [US6M2GTR](#) [DMN31D5UDJ-7](#)  
[SSM6P54TU,LF](#) [DMP22D4UFO-7B](#) [IPS60R3K4CEAKMA1](#) [DMN1006UCA6-7](#) [DMN16M9UCA6-7](#) [STF5N65M6](#) [STU5N65M6](#)  
[C3M0021120D](#) [DMN13M9UCA6-7](#) [BSS340NWH6327XTSA1](#) [MCM3400A-TP](#) [DMTH10H4M6SPS-13](#) [IRF40SC240ARMA1](#)  
[IPS60R1K0PFD7SAKMA1](#)