



**TO-92 Plastic-Encapsulate Transistors**

**2SA950** TRANSISTOR (PNP)

**FEATURES**

- 1W Output Applications
- Complementary to 2SC2120

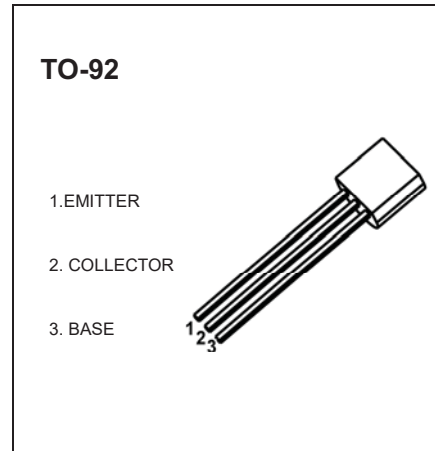

**MARKING**

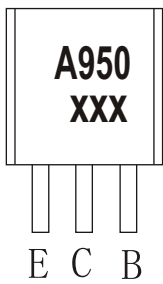

A950=Device code  
 XXX=Code  
 GXX=Green molding compound device  
 CXX=Normal molding compound device

**Equivalent Circuit**

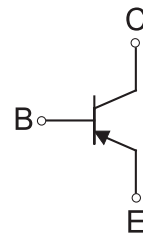

**ORDERING INFORMATION**

Part Number	Package	Packing Method	Pack Quantity
2SA950	TO-92	Bulk	1000pcs/Bag
2SA950-TA	" O-92	"ape	2000pcs/Box

**MAXIMUM RATINGS (T<sub>a</sub>=25°C unless otherwise noted)**

Symbol	Parameter	Value	Unit
V <sub>CB0</sub>	Collector-Base Voltage	-35	V
V <sub>CE0</sub>	Collector-Emitter Voltage	-30	V
V <sub>EB0</sub>	Emitter-Base Voltage	-5	V
I <sub>c</sub>	Collector Current -Continuous	-0.8	A
P <sub>D</sub>	Collector Power Dissipation	600	mW
R <sub>KJA</sub>	Thermal Resistance ^rom Junction `o Ambient	208	°C /W
T <sub>J</sub> ,T <sub>stg</sub>	Operation Junction and Storage Temperature Range	-55~+150	°C

## ELECTRICAL CHARACTERISTICS

$T_a=25^\circ\text{C}$  unless otherwise specified

Parameter	Symbol	Test conditions	M&+	T0!	Max	U+&'
Collector-base breakdown voltage	$V_{(BR)CBO}$	$I_C = -0.1\text{mA}$ , $I_E = 0$	-35			V
Collector-emitter breakdown voltage	$V_{(BR)CEO}$	$I_C = -10\text{mA}$ , $I_B = 0$	-30			V
Emitter-base breakdown voltage	$V_{(BR)EBO}$	$I_E = -0.1\text{mA}$ , $I_C = 0$	-5			V
Collector cut-off current	$I_{CBO}$	$V_{CB} = -35\text{V}$ , $I_E = 0$			-0.1	$\mu\text{A}$
Emitter cut-off current	$I_{EBO}$	$V_{EB} = -5\text{V}$ , $I_C = 0$			-0.1	$\mu\text{A}$
DC current gain	$h_{FE(1)}$	$V_{CE} = -1\text{V}$ , $I_C = -100\text{mA}$	100		320	
	$h_{FE(2)}$	$V_{CE} = -1\text{V}$ , $I_C = -700\text{mA}$	35			
Collector-emitter saturation voltage	$V_{CE(sat)}$	$I_C = -500\text{mA}$ , $I_B = -20\text{mA}$			-0.7	V
Emitter-base voltage	$V_{BE}$	$V_{CE} = -1\text{V}$ , $I_C = -10\text{mA}$	-0.5		-0.8	V
Collector Output Capacitance	$C_{ob}$	$V_{CB} = -10\text{V}$ , $I_E = 0$ $f = 1\text{MHz}$		19		pF
Transition frequency	$f_T$	$V_{CE} = -5\text{V}$ , $I_C = -10\text{mA}$		120		MHz

### CLASSIFICATION OF $h_{FE(1)}$

Rank	O	Y
Range	100-200	160-320

# Typical Characteristics

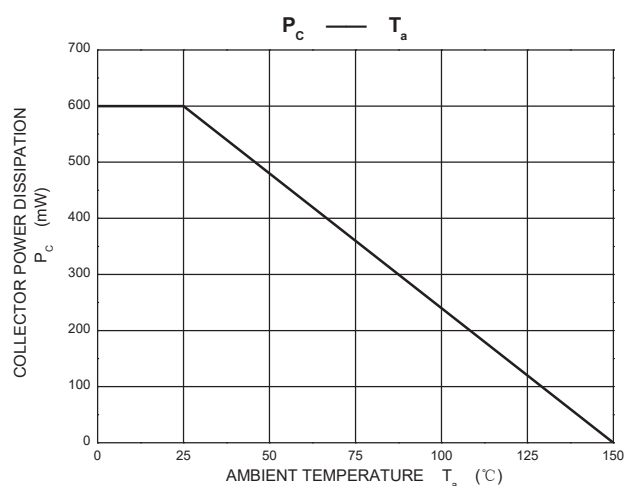
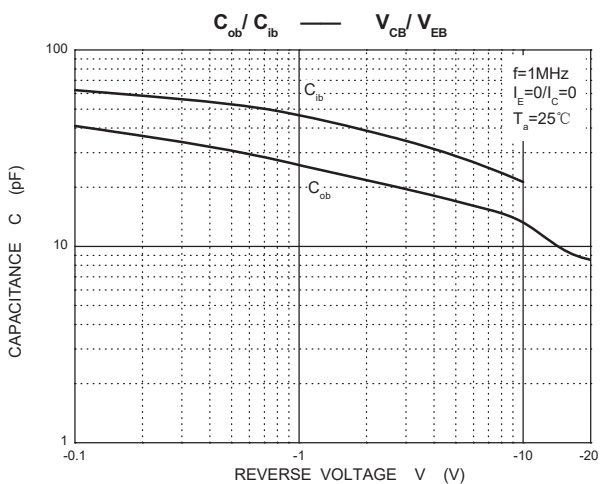
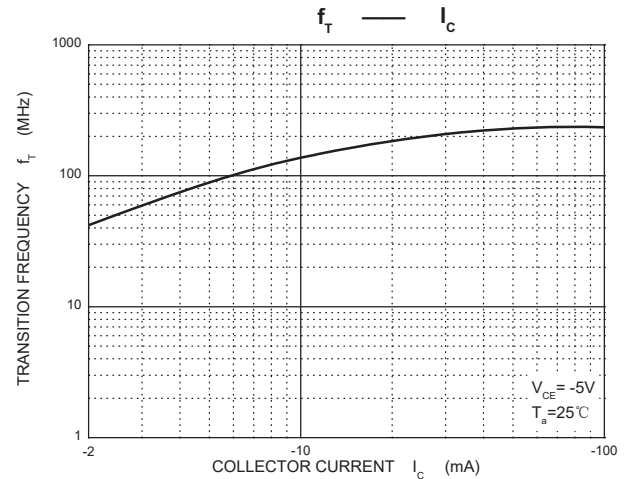
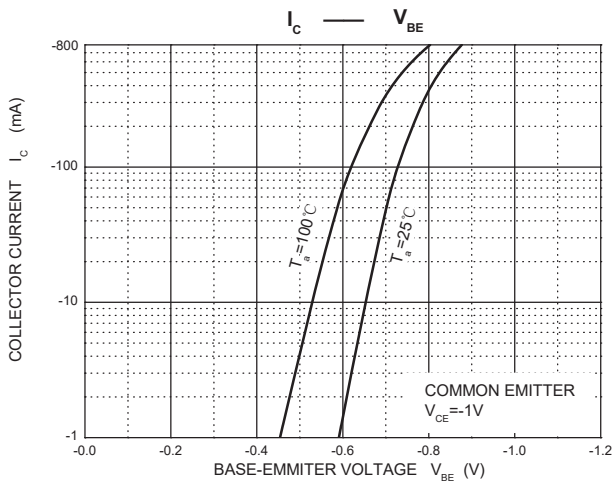
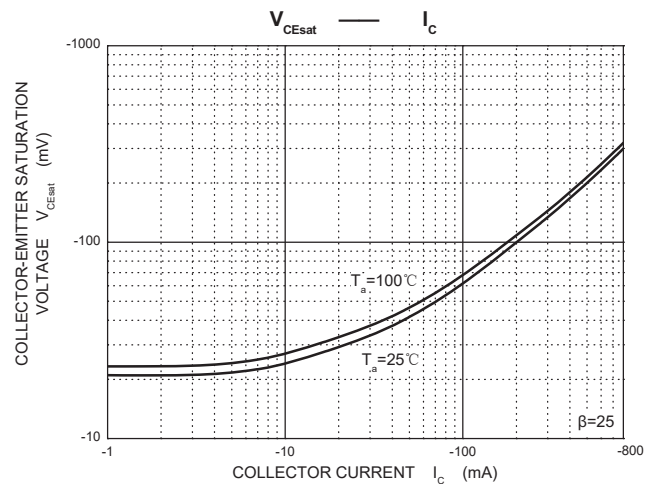
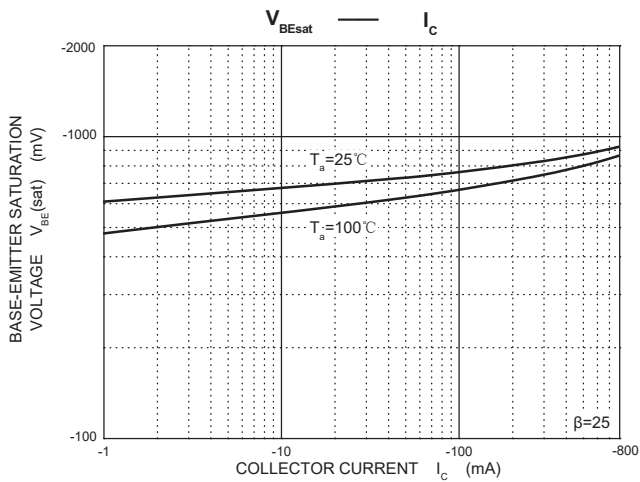
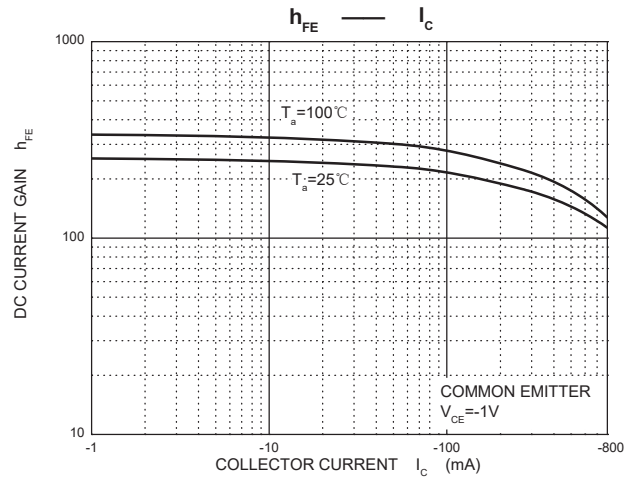
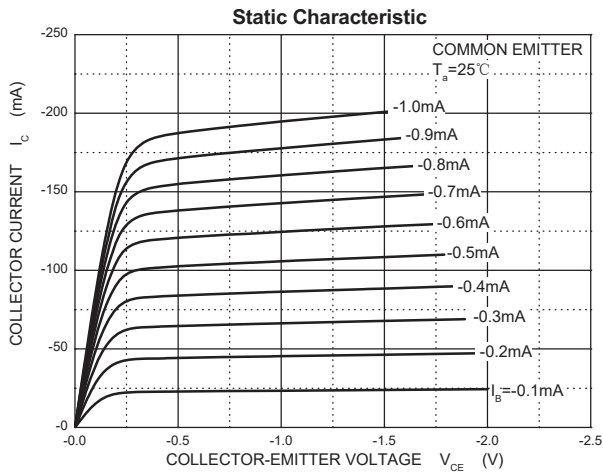

## TO-92 Package Outline Dimensions

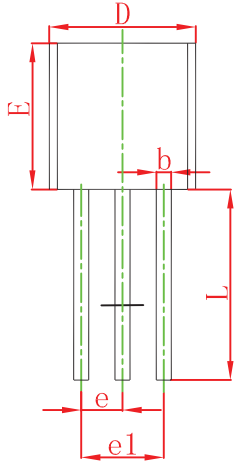
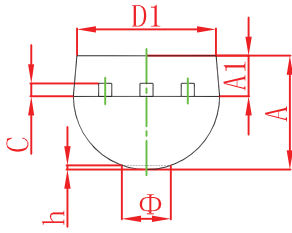

Symbol	Dimensions In Millimeters		Dimensions In Inches	
	Min	Max	Min	Max
A	3.300	3.700	0.130	0.146
A1	1.100	1.400	0.043	0.055
b	0.380	0.550	0.015	0.022
c	0.360	0.510	0.014	0.020
D	4.300	4.700	0.169	0.185
D1	3.430		0.135	
E	4.300	4.700	0.169	0.185
e	1.270 TYP		0.050 TYP	
e1	2.440	2.640	0.096	0.104
L	14.100	14.500	0.555	0.571
v		1.600		0.063
h	0.000	0.380	0.000	0.015

## TO-92 Suggested Pad Layout

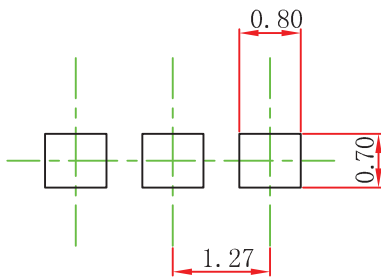

### Note:

1. Controlling dimension: in millimeters.
2. General tolerance:  $\pm 0.05\text{mm}$ .
3. The pad layout is for reference purposes only.

### NOTICE

JSCJ reserves the right to make modifications, enhancements, improvements, corrections or other changes without further notice to any product herein. JSCJ does not assume any liability arising out of the application or use of any product described herein.

# TO-92 Tape and Reel

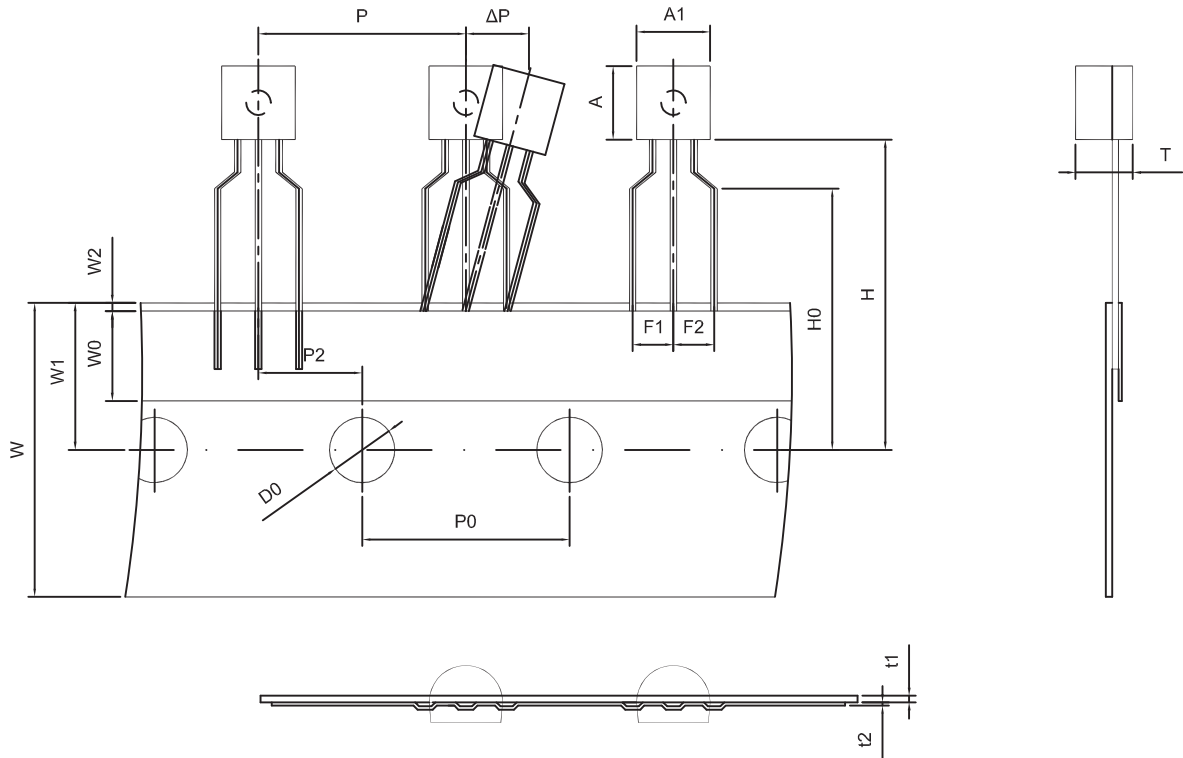

Dimiensions are in millimeter

A1	A	T	P	P0	P2	F1	F2	W
4.5	4.5	3.5	12.7	12.7	6.35	2.5	2.5	18.0
W0	W1	W2	H	H0	D0	t1	t2	$\Delta P$
6.0	9.0	1.0 MAX.	19.0	16.0	4.0	0.4	0.2	0

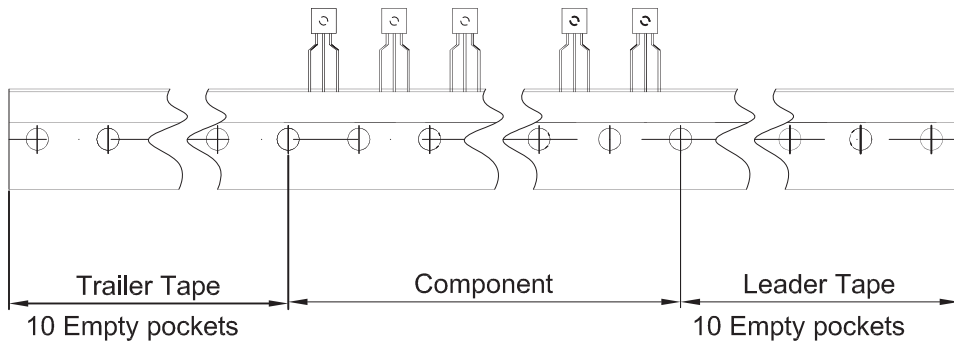

Package	Box	Box Size(mm)	Carton	Carton Size(mm)
TO-92	2000 pcs	333×162×43	20,000 pcs	350×340×250

## X-ON Electronics

Largest Supplier of Electrical and Electronic Components

*Click to view similar products for [Bipolar Transistors - BJT category](#):*

*Click to view products by [Changjing Electronics Technology manufacturer](#):*

Other Similar products are found below :

[BC559C](#) [MCH4017-TL-H](#) [MMBT-2369-TR](#) [BC546/116](#) [NJVMJD148T4G](#) [NTE16](#) [NTE195A](#) [IMX9T110](#) [2N4401-A](#) [2N4403](#) [2N6728](#)  
[2SA1419T-TD-H](#) [2SA2126-E](#) [2SB1204S-TL-E](#) [FMC5AT148](#) [2N2369ADCSM](#) [2N2907A](#) [2N3904-NS](#) [2N5769](#) [2SC4618TLN](#) [CPH6501-](#)  
[TL-E](#) [MCH4021-TL-E](#) [Jantx2N5416](#) [US6T6TR](#) [BAX18/A52R](#) [BC556/112](#) [IMZ2AT108](#) [MMST8098T146](#) [UMX21NTR](#) [MCH6102-TL-E](#)  
[TTA1452B,S4X\(S](#) [2N3879](#) [NTE13](#) [NTE282](#) [NTE323](#) [NTE350](#) [NTE81](#) [JANTX2N2920L](#) [JANTX2N3735](#) [JANSR2N2222AUB](#)  
[CMLT3946EG TR](#) [SNSS40600CF8T1G](#) [CMLT3906EG TR](#) [GRP-DATA-JANS2N2907AUB](#) [GRP-DATA-JANS2N2222AUA](#)  
[MMDT3946FL3-7](#) [2N4240](#) [MSB30KH-13](#) [2N2221AUB](#) [2SD1815T-TL-E](#)