

JSCJ JIANGSU CHANGJING ELECTRONICS TECHNOLOGY CO., LTD
JSCJ TO-92S Plastic-Encapsulate Transistors

2SC4115S TRANSISTOR (NPN)

FEATURES

- Low $V_{CE(sat)}$.
- Excellent Current Gain Characteristics.
- Complements The 2SA1585S.

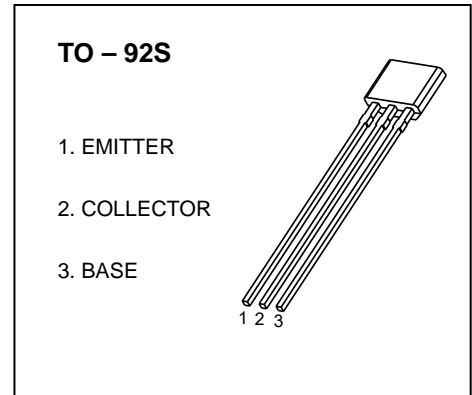

MARKING

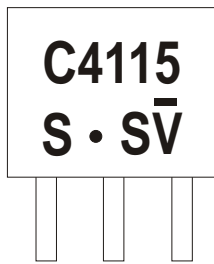

C4115S=Device code
 Solid dot = Green molding compound device,
 if none, the normal device
 XXX=Code

Equivalent Circuit

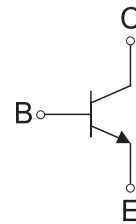

ORDERING INFORMATION

Part Number	Package	Packing Method	Pack Quantity
2SC4115S	TO-92S	Bulk	1000pcs/Bag
2SC4115S-TA	TO-92S	Tape	3000pcs/Box

MAXIMUM RATINGS ($T_a=25^\circ\text{C}$ unless otherwise noted)

Symbol	Parameter	Value	Unit
V_{CBO}	Collector-Base Voltage	40	V
V_{CEO}	Collector-Emitter Voltage	20	V
V_{EBO}	Emitter-Base Voltage	6	V
I_C	Collector Current	3	A
P_C	Collector Power Dissipation	300	mW
$R_{\theta JA}$	Thermal Resistance From Junction To Ambient	417	$^\circ\text{C}/\text{W}$
T_J, T_{stg}	Operation Junction and Storage Temperature Range	-55~+150	$^\circ\text{C}$

ELECTRICAL CHARACTERISTICS

$T_a=25\text{ }^\circ\text{C}$ unless otherwise specified

Parameter	Symbol	Test conditions	Min	Typ	Max	Unit
Collector-base breakdown voltage	$V_{(BR)CBO}$	$I_C=0.05\text{mA}, I_E=0$	40			V
Collector-emitter breakdown voltage	$V_{(BR)CEO}$	$I_C=1\text{mA}, I_B=0$	20			V
Emitter-base breakdown voltage	$V_{(BR)EBO}$	$I_E=0.05\text{mA}, I_C=0$	6			V
Collector cut-off current	I_{CBO}	$V_{CB}=30\text{V}, I_E=0$			0.1	μA
Emitter cut-off current	I_{EBO}	$V_{EB}=5\text{V}, I_C=0$			0.1	μA
DC current gain	h_{FE}	$V_{CE}=2\text{V}, I_C=100\text{mA}$	120		560	
Collector-emitter saturation voltage	$V_{CE(sat)}$ *	$I_C=2\text{A}, I_B=0.1\text{A}$			0.5	V
Collector output capacitance	C_{ob}	$V_{CB}=10\text{V}, I_E=0, f=1\text{MHz}$		25		pF
Transition frequency	f_T	$V_{CE}=2\text{V}, I_C=0.5\text{A}, f=100\text{MHz}$		290		MHz

*Pulse test

CLASSIFICATION OF h_{FE}

RANK	Q	R	S
RANGE	120-270	180-390	270-560

Typical Characteristics

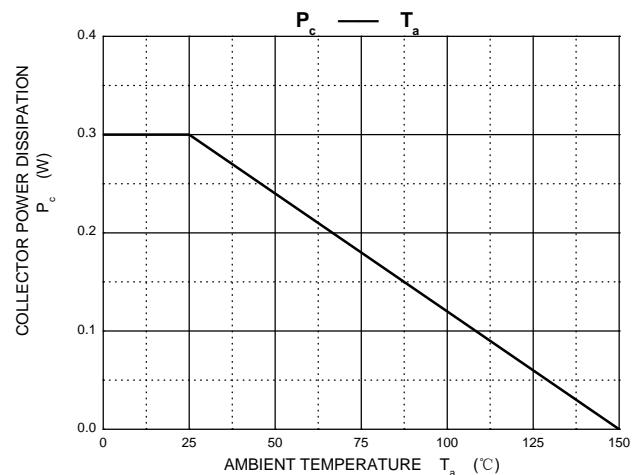
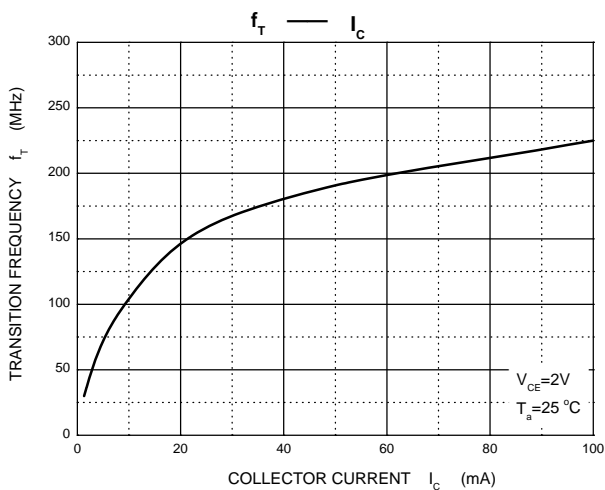
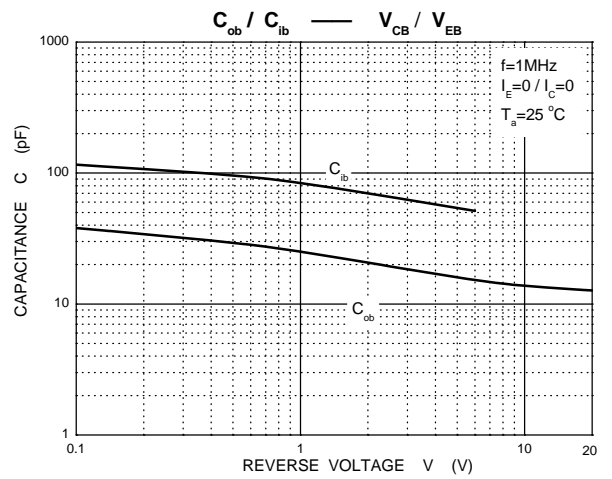
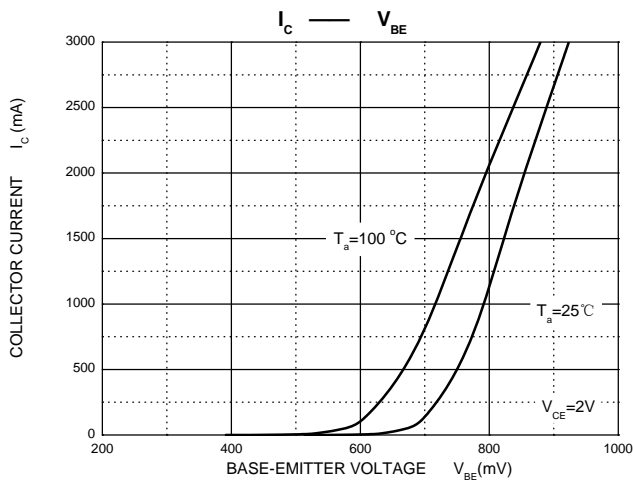
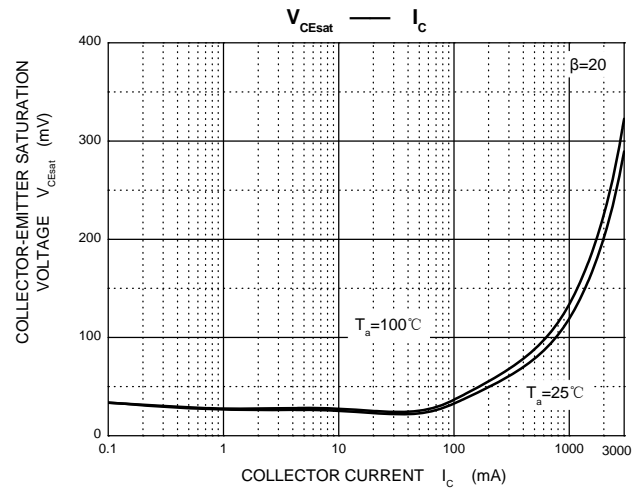
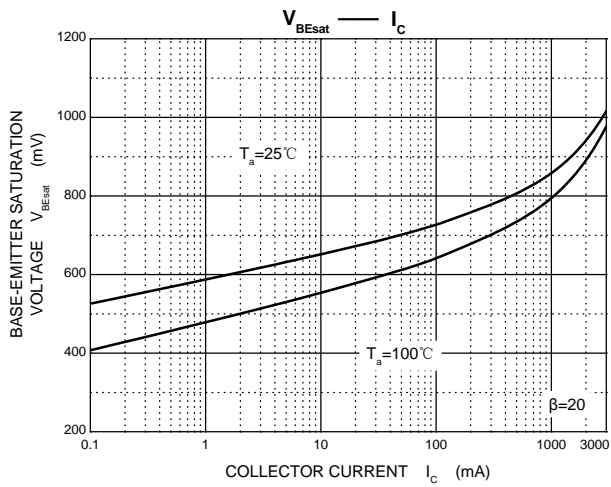
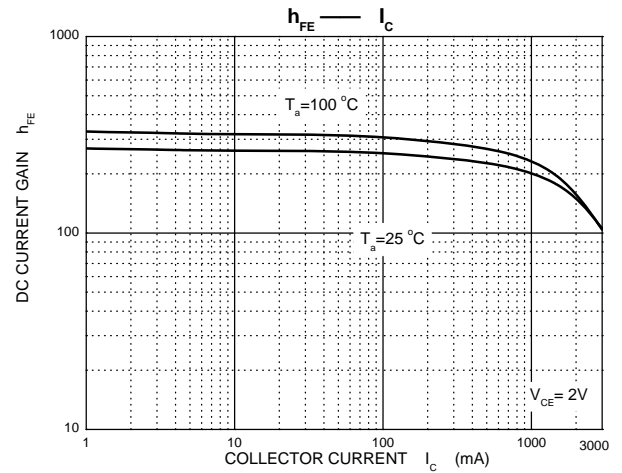
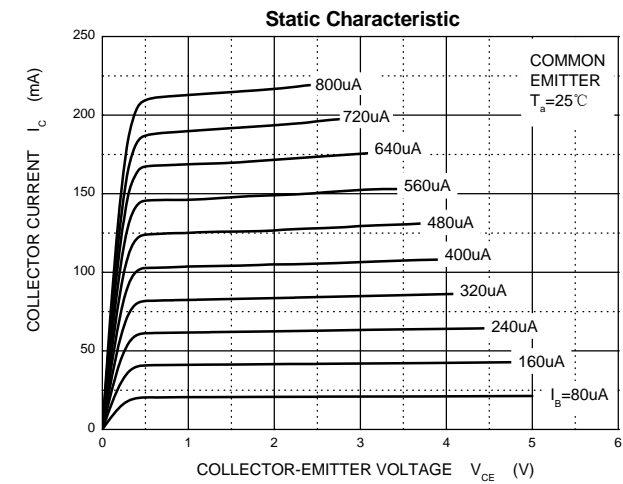

TO-92S Package Outline Dimensions

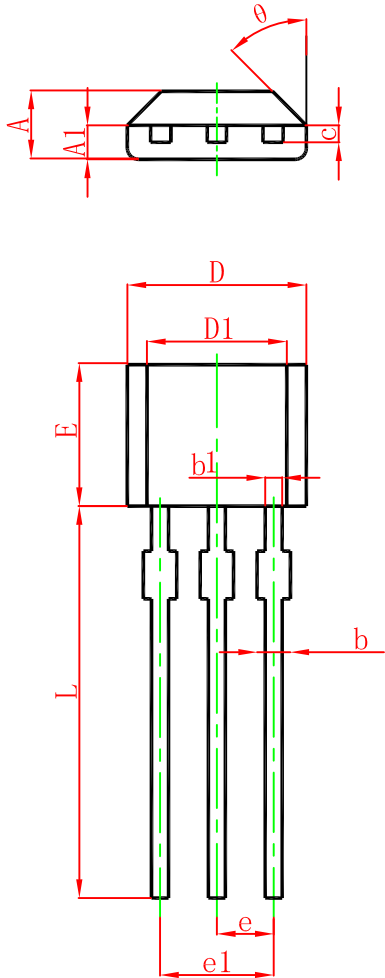

Symbol	Dimensions In Millimeters		Dimensions In Inches	
	Min.	Max.	Min.	Max.
A	1.420	1.620	0.056	0.064
A1	0.660	0.860	0.026	0.034
b	0.330	0.480	0.013	0.019
b1	0.400	0.510	0.016	0.020
c	0.330	0.510	0.013	0.020
D	3.900	4.100	0.154	0.161
D1	2.280	2.680	0.090	0.106
E	3.050	3.250	0.120	0.128
e	1.270 TYP.		0.050 TYP.	
e1	2.440	2.640	0.096	0.104
L	15.100	15.500	0.594	0.610
θ	45° TYP.		45° TYP.	

TO-92S Suggested Pad Layout

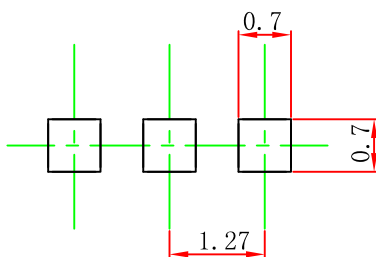

Note:

1. Controlling dimension: in millimeters.
2. General tolerance: ± 0.05 mm.
3. The pad layout is for reference purposes only.

NOTICE

JSCJ reserves the right to make modifications, enhancements, improvements, corrections or other changes without further notice to any product herein. JSCJ does not assume any liability arising out of the application or use of any product described herein.

TO-92S PACKAGE TAPING DIMENSION

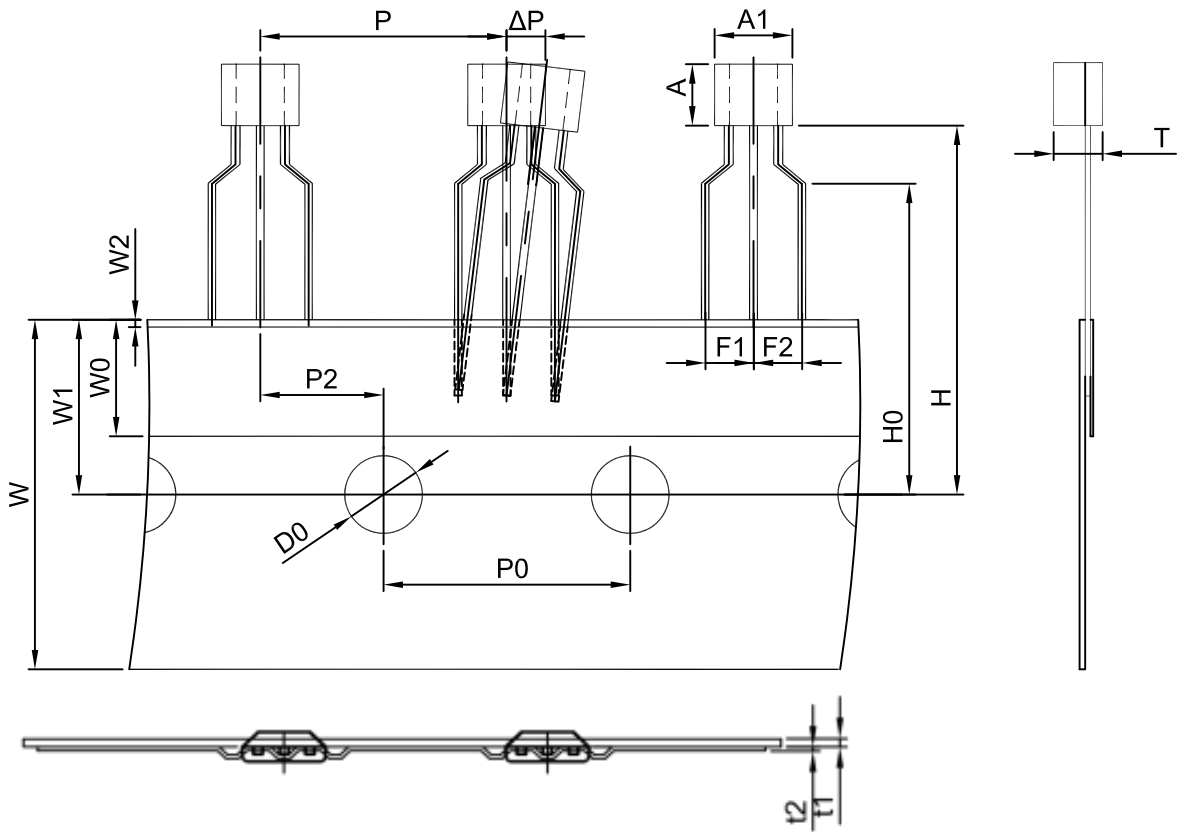

Dimensions are in millimeter

A1	A	T	P	P0	P2	F1	F2	W
4.0	3.15	1.52	12.7	12.7	6.35	2.5	2.5	18.0
W0	W1	W2	H	H0	D0	t1	t2	ΔP
6.0	9.0	1.0	19.0	16.0	4.0	0.4	0.2	0

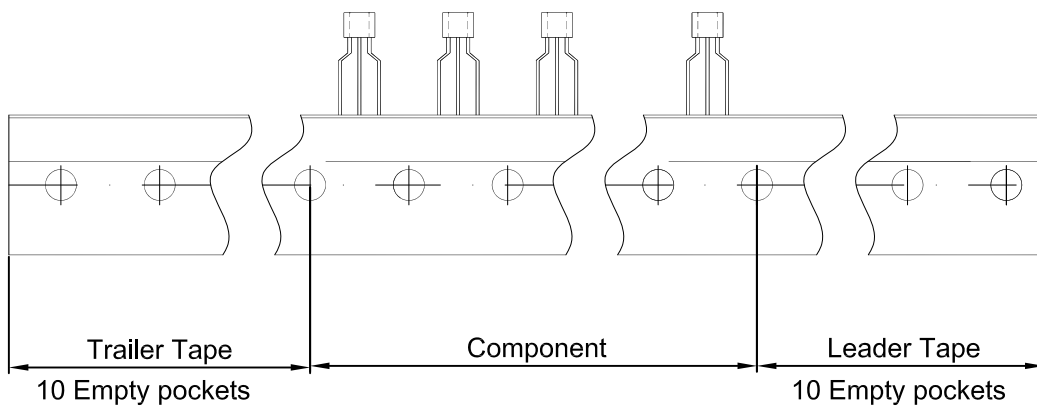

Package	Box	Box Size(mm)	Carton	Carton Size(mm)
TO-92S	3000 pcs	333×162×43	30,000 pcs	350×340×250

X-ON Electronics

Largest Supplier of Electrical and Electronic Components

Click to view similar products for [Bipolar Transistors - BJT category](#):

Click to view products by [Changjing Electronics Technology manufacturer](#):

Other Similar products are found below :

[619691C](#) [MCH4017-TL-H](#) [MMBT-2369-TR](#) [BC546/116](#) [BC557/116](#) [BSW67A](#) [NJVMJD148T4G](#) [NTE123AP-10](#) [NTE153MCP](#) [NTE16](#)
[NTE195A](#) [NTE92](#) [C4460](#) [2N4401-A](#) [2N6728](#) [2SA1419T-TD-H](#) [2SA2126-E](#) [2SB1204S-TL-E](#) [2SC2712S-GR,LF](#) [2SC5488A-TL-H](#)
[2SD2150T100R](#) [SP000011176](#) [2N2907A](#) [2N3904-NS](#) [2N5769](#) [2SC2412KT146S](#) [2SD1816S-TL-E](#) [CPH6501-TL-E](#) [MCH4021-TL-E](#)
[MJE340](#) [US6T6TR](#) [NJL0281DG](#) [732314D](#) [CPH3121-TL-E](#) [CPH6021-TL-H](#) [873787E](#) [IMZ2AT108](#) [UMX21NTR](#) [MCH6102-TL-E](#)
[NJL0302DG](#) [2N3583](#) [30A02MH-TL-E](#) [TN6717A](#) [NSV40301MZ4T1G](#) [NTE13](#) [NTE26](#) [NTE282](#) [NTE323](#) [NTE350](#) [NTE81](#)