



AD-BC846W/47W/48W Series Plastic-Encapsulated Transistor

AD-BC846W/47W/48W series Transistor (NPN)

FEATURES

- Ideally suited for automatic insertion
- For switching and AF amplifier applications
- AEC-Q101 qualified

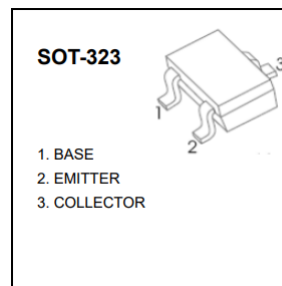

MARKING

AD-BC846W-A = $\bar{1}A$; AD-BC846W-B = $\bar{1}B$;
 AD-BC847W-A = $\bar{1}E$; AD-BC847W-B = $\bar{1}F$; AD-BC847W-C = $\bar{1}G$;
 AD-BC848W-A = $\bar{1}J$; AD-BC848W-B = $\bar{1}K$; AD-BC848W-C = $\bar{1}L$

The additional A/B/C indicate the different h_{FE} .

MAXIMUM RATINGS ($T_j = 25^\circ\text{C}$ unless otherwise specified)

Parameter	Symbol	Value	Unit
Collector-base voltage	V_{CBO}	80	V
		50	
		30	
Collector-emitter voltage	V_{CEO}	65	V
		45	
		30	
Emitter-base voltage	V_{EBO}	6	V
		6	
		5	
Collector continuous current	$I_C^{(1)}$	0.1	A
Collector power dissipation	$P_C^{(1)}$	150	mW
Thermal resistance from junction to ambient	$R_{\theta JA}^{(2)}$	833	$^\circ\text{C}/\text{W}$
Operating junction and storage temperature range	T_j, T_{stg}	-55 ~ 150	$^\circ\text{C}$

ELECTRICAL CHARACTERISTICS ($T_j = 25^\circ\text{C}$ unless otherwise specified)

Parameter		Symbol	Test condition	Min	Typ	Max	Unit
Collector-base breakdown voltage	AD-BC846W*	V_{CB0}	$I_C = 10\mu\text{A}, I_E = 0\text{A}$	80	-	-	V
	AD-BC847W*			50	-	-	
	AD-BC848W*			30	-	-	
Collector-emitter breakdown voltage	AD-BC846W*	V_{CEO}	$I_C = 10\text{mA}, I_B = 0\text{A}$	65	-	-	V
	AD-BC847W*			45	-	-	
	AD-BC848W*			30	-	-	
Emitter-base breakdown voltage	AD-BC846W*	V_{EBO}	$I_E = 1\mu\text{A}, I_C = 0\text{A}$	6	-	-	V
	AD-BC847W*			6	-	-	
	AD-BC848W*			5	-	-	
Collector cutoff current		I_{CBO}	$V_{CB} = 30\text{V}$	-	-	15	nA
DC current gain	AD-BC84*W-A	h_{FE1}	$V_{CE} = 5\text{V}, I_C = 10\mu\text{A}$	-	90	-	-
	AD-BC84*W-B			-	150	-	
	AD-BC84*W-C			-	270	-	
	AD-BC84*W-A	h_{FE2}	$V_{CE} = 5\text{V}, I_C = 2\text{mA}$	110	-	220	-
	AD-BC84*W-B			200	-	450	
	AD-BC84*W-C			420	-	800	
Collector-emitter saturation voltage		$V_{CE(sat)}$	$I_C = 10\text{mA}, I_B = 0.5\text{mA}$	-	-	0.25	V
			$I_C = 100\text{mA}, I_B = 5\text{mA}$	-	-	0.6	
Base-emitter saturation voltage		$V_{BE(sat)}$	$I_C = 10\text{mA}, I_B = 0.5\text{mA}$	-	0.7	-	V
			$I_C = 100\text{mA}, I_B = 5\text{mA}$	-	0.9	-	
Base-emitter voltage		$V_{BE(on)}$	$V_{CE} = 5\text{V}, I_C = 2\text{mA}$	580	660	700	mV
			$I_C = 100\text{mA}, I_B = 5\text{mA}$	-	-	770	
Transition frequency		f_T	$V_{CE} = 5\text{V}, I_C = 2\text{mA}, f = 100\text{MHz}$	100	-	-	MHz
Collector output capacitance		C_{ob}	$V_{CB} = 5\text{V}, f = 1\text{MHz}$	-	-	4.5	pF
Noise figure	AD-BC84*W-A	NF	$V_{CE} = 5\text{V}, I_C = 0.2\text{mA}, f = 1\text{KHz}, R_S = 2\text{K}\Omega, \text{BW} = 200\text{Hz}$	-	-	10	dB
	AD-BC84*W-B			-	-	10	
	AD-BC84*W-C			-	-	4	

1) Maximum allowed temperature $T_j = 25^\circ\text{C}$.2) Measured with the device mounted on 1 inch² FR-4 board with 1oz. copper, in a still air environment with $T_a = 25^\circ\text{C}$.

TYPICAL CHARACTERISTICS

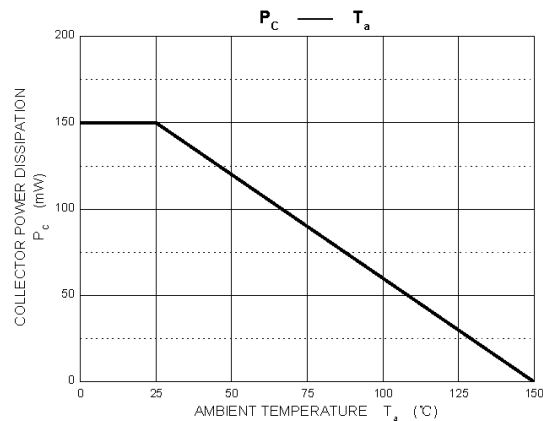
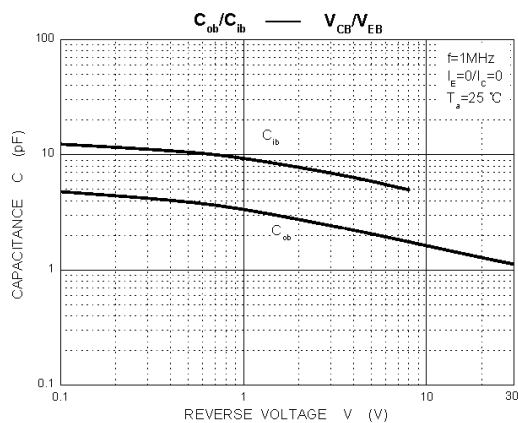
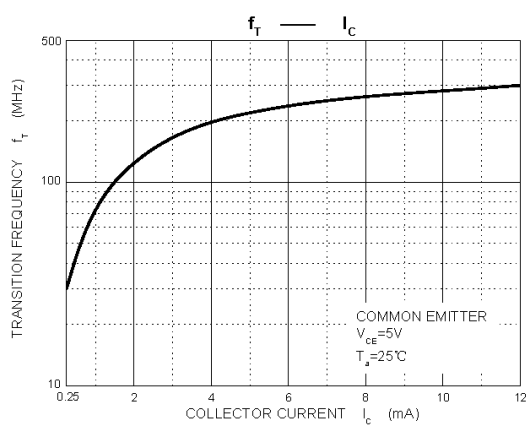
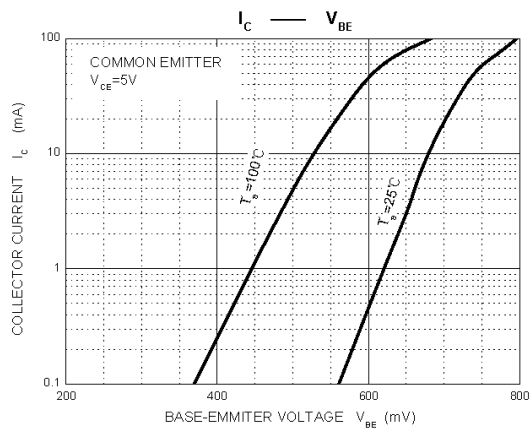
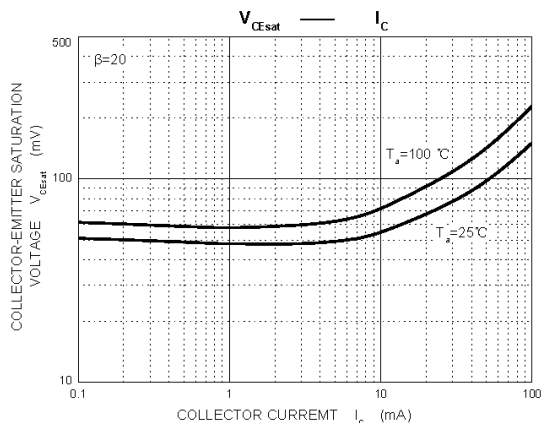
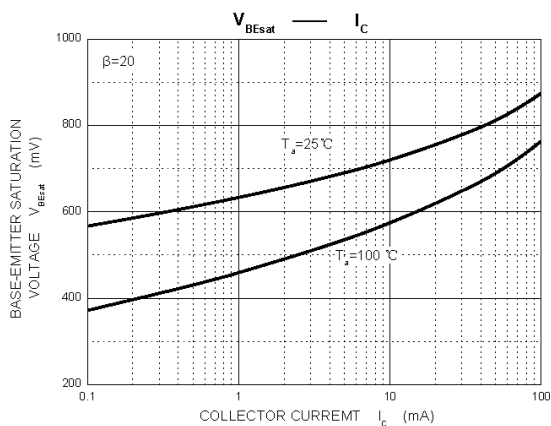
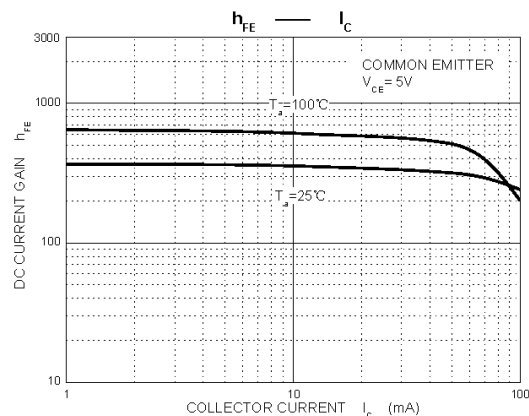
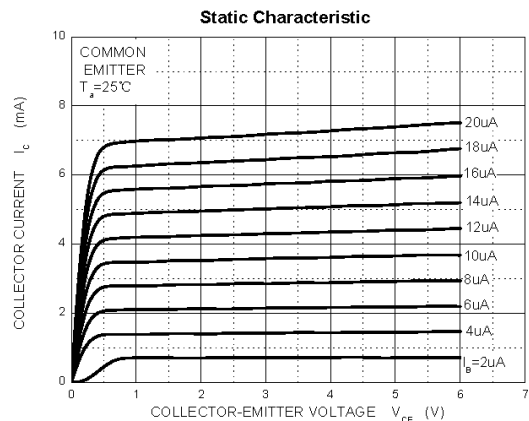

SOT-323 PACKAGE OUTLINE DIMENSIONS

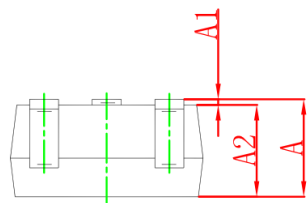
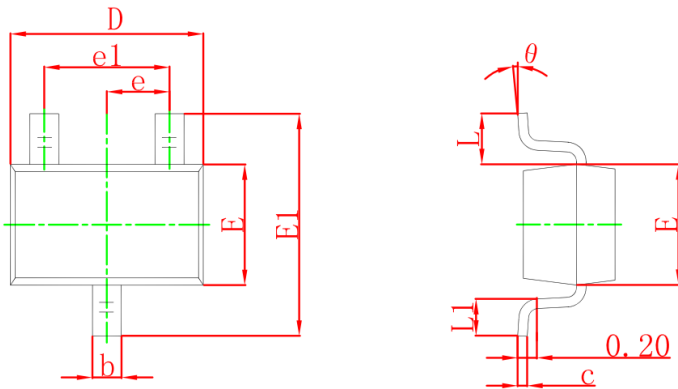

Symbol	Dimensions In Millimeters		Dimensions In Inches	
	Min	Max	Min	Max
A	0.900	1.100	0.035	0.043
A1	0.000	0.100	0.000	0.004
A2	0.900	1.000	0.035	0.039
b	0.200	0.400	0.008	0.016
c	0.080	0.150	0.003	0.006
D	2.000	2.200	0.079	0.087
E	1.150	1.350	0.045	0.053
E1	2.150	2.450	0.085	0.096
e	0.650 TYP		0.026 TYP	
e1	1.200	1.400	0.047	0.055
L	0.525 REF		0.021 REF	
L1	0.260	0.460	0.010	0.018
θ	0°	8°	0°	8°

SOT-323 SUGGESTED PAD LAYOUT

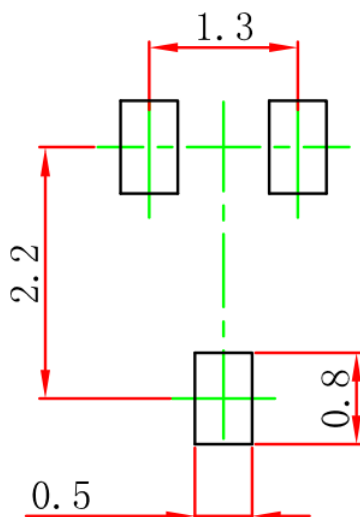

Note:

1. Controlling dimension in millimeters.
2. General tolerance: $\pm 0.05\text{mm}$.
3. The pad layout is for reference purpose only.

SOT-323 TAPE AND REEL

SOT-323 Embossed Carrier Tape

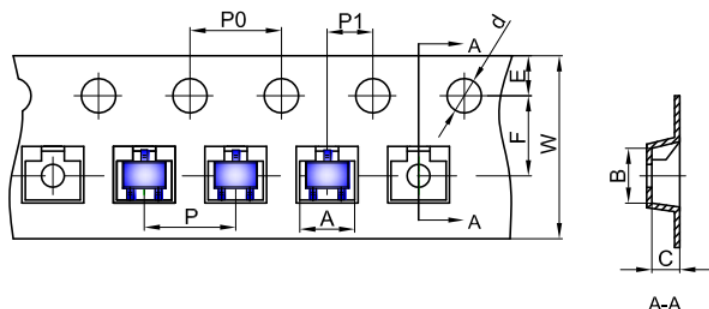

Packaging Description:
 SOT-323 parts are shipped in tape. The carrier tape is made from a dissipative (carbon filled) polycarbonate resin. The cover tape is a multilayer film (Heat Activated Adhesive in nature) primarily composed of polyester film, adhesive layer, sealant, and anti-static sprayed agent. These reeled parts in standard option are shipped with 3,000 units per 7" or 17.8cm diameter reel. The reels are clear in color and is made of polystyrene plastic (anti-static coated).

Dimensions are in millimeter											
Pkg type	A	B	C	d	E	F	P0	P	P1	W	
SOT-323	2.25	2.55	1.19	Ø1.55	1.75	3.50	4.00	4.00	2.00	8.00	

SOT-323 Tape Leader and Trailer

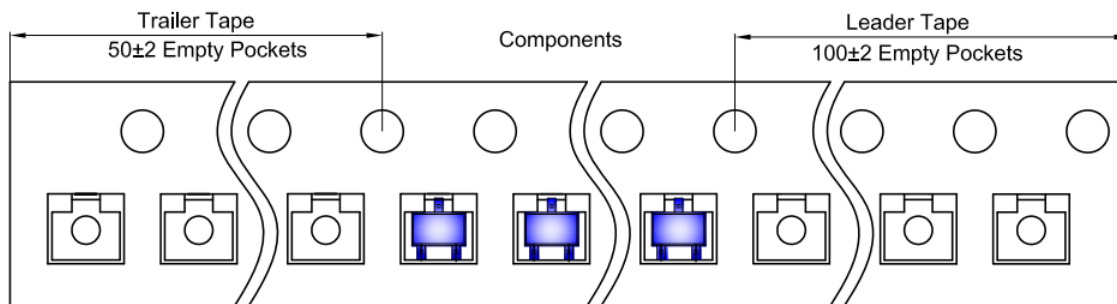

SOT-323 Reel

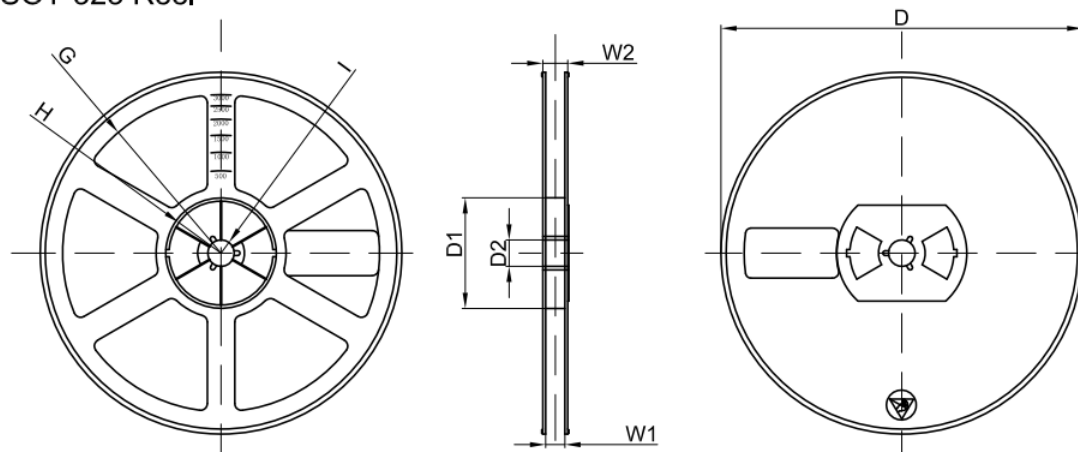

Dimensions are in millimeter								
Reel Option	D	D1	D2	G	H	I	W1	W2
7" Dia	Ø178.00	54.40	13.00	R78.00	R25.60	R6.50	9.50	12.30

REEL	Reel Size	Box	Box Size(mm)	Carton	Carton Size(mm)	G.W.(kg)
3000 pcs	7 inch	45,000 pcs	203×203×195	180,000 pcs	438×438×220	

PUBLISHED BY**JIANGSU CHANGJING ELECTRONICS TECHNOLOGY CO., LTD.**

13th Floor, C Block, Tengfei Building, Yan Chuang Yuan, Nanjing Jiangbei New Area, China

LEGAL DISCLAIMER

The information given in this document shall in no event be regarded as a guarantee of conditions or characteristics. With respect to any examples, hints or typical values stated herein and/or any information regarding the application of the device, JSCJ hereby disclaims any and all warranties and liabilities of any kind, including without limitation, warranties of non-infringement of intellectual property rights of any third party.

In addition, any information given in this document is subject to customer's compliance with its obligations stated in this document and any applicable legal requirements, norms and standards concerning customer's products and any use of the product of JSCJ in customer's applications.

The data contained in this document is exclusively intended for technically trained staff. It is the responsibility of customer's technical departments to evaluate the suitability of the product for the intended application and the completeness of the product information given in this document with respect to such application.

INFORMATION

For further information on technology, delivery terms and conditions as well as prices, please contact your nearest JSCJ office (www.jscj-elec.com).

WARNINGS

Due to technical requirements, products may contain dangerous substances. For information on the types in question, please contact your nearest JSCJ office.

Except as otherwise explicitly approved by JSCJ in a written document signed by authorized representatives of JSCJ, JSCJ's products may not be used in any applications where a failure of the product or any consequences of the use thereof can reasonably be expected to result in personal injury.

X-ON Electronics

Largest Supplier of Electrical and Electronic Components

Click to view similar products for [Bipolar Transistors - BJT category](#):

Click to view products by [Changjing Electronics Technology manufacturer](#):

Other Similar products are found below :

[BC559C](#) [MCH4017-TL-H](#) [MMBT-2369-TR](#) [BC546/116](#) [NJVMJD148T4G](#) [NTE16](#) [NTE195A](#) [IMX9T110](#) [2N4401-A](#) [2N4403](#) [2N6728](#)
[2SA1419T-TD-H](#) [2SA2126-E](#) [2SB1204S-TL-E](#) [FMC5AT148](#) [2N2369ADCSM](#) [2N2907A](#) [2N3904-NS](#) [2N5769](#) [2SC4618TLN](#) [CPH6501-](#)
[TL-E](#) [MCH4021-TL-E](#) [Jantx2N5416](#) [US6T6TR](#) [BAX18/A52R](#) [BC556/112](#) [IMZ2AT108](#) [MMST8098T146](#) [UMX21NTR](#) [MCH6102-TL-E](#)
[TTA1452B,S4X\(S](#) [2N3879](#) [NTE13](#) [NTE282](#) [NTE323](#) [NTE350](#) [NTE81](#) [JANTX2N2920L](#) [JANTX2N3735](#) [JANSR2N2222AUB](#)
[CMLT3946EG TR](#) [SNSS40600CF8T1G](#) [CMLT3906EG TR](#) [GRP-DATA-JANS2N2907AUB](#) [GRP-DATA-JANS2N2222AUA](#)
[MMDT3946FL3-7](#) [2N4240](#) [JANS2N3019](#) [MSB30KH-13](#) [2N2221AUB](#)