



AD-BCP51/52/53 series Plastic-Encapsulated Transistor

AD-BCP51/52/53 series Transistor (PNP)

FEATURES

- For AF driver and output stages
- High collector current
- Low collector-emitter saturation voltage
- Complementary types: AD-BCP54/55/56 series (NPN)
- AEC-Q101 qualified

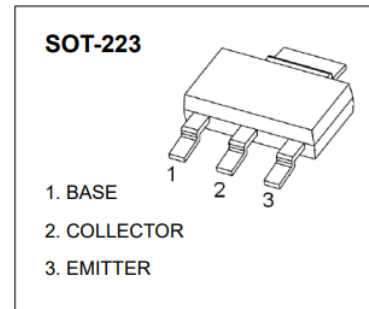

MAXIMUM RATINGS ($T_j = 25^\circ\text{C}$ unless otherwise specified)

Parameter	Symbol	AD-BCP51*	AD-BCP52*	AD-BCP53*	Unit
Collector-base voltage	V_{CB0}	-45	-60	-100	V
Collector-emitter voltage	V_{CEO}	-45	-60	-80	V
Emitter-base voltage	V_{EBO}		-5		V
Collector continuous current	$I_C^{(1)}$		-1		A
Peak pulsed collector current	I_{CM}		-2		A
Base continuous current	I_B		-100		mA
Peak pulsed base current	I_{BM}		-200		mA
Collector power dissipation	$P_C^{(1)}$		1.5		W
Thermal resistance from junction to ambient	$R_{\theta JA}^{(2)}$		94		$^\circ\text{C/W}$
Operating junction and storage temperature range	T_j, T_{stg}		-55 ~ 150		$^\circ\text{C}$

ELECTRICAL CHARACTERISTICS ($T_j = 25^\circ\text{C}$ unless otherwise specified)

Parameter		Symbol	Test condition	Min	Typ	Max	Unit
Collector-base breakdown voltage	AD-BCP51*	$V_{(BR)CB0}$	$I_C = -0.1\text{mA}, I_E = 0\text{A}$	-45	-	-	V
	AD-BCP52*			-60	-	-	
	AD-BCP53*			-100	-	-	
Collector-emitter breakdown voltage	AD-BCP51*	$V_{(BR)CEO}$	$I_C = -10\text{mA}, I_B = 0\text{A}$	-45	-	-	V
	AD-BCP52*			-60	-	-	
	AD-BCP53*			-80	-	-	
Base-emitter breakdown voltage		$V_{(BR)EBO}$	$I_E = -10\mu\text{A}, I_C = 0\text{A}$	-5	-	-	V
Collector-base cut-off current		I_{CB0}	$V_{CB} = -30\text{V}, I_E = 0\text{A}$	-	-	-100	nA
DC current gain		$h_{FE(1)}$	$V_{CE} = -2\text{V}, I_C = -5\text{mA}$	25	-	-	-
		$h_{FE(2)}$	$V_{CE} = -2\text{V}, I_C = -150\text{mA}$	63	-	250	
		$h_{FE(3)}$	$V_{CE} = -2\text{V}, I_C = -500\text{mA}$	25	-	-	
Collector-emitter saturation voltage		$V_{CE(sat)}$	$I_C = -500\text{mA}, I_B = -50\text{mA}$	-	-	-0.5	V
Base-emitter voltage		V_{BE}	$I_C = -500\text{mA}, V_{CE} = -2\text{V}$	-	-	-1	V
Transition frequency		f_T	$V_{CE} = -10\text{V}, I_C = -50\text{mA}, f = 100\text{MHz}$	100	-	-	MHz

CLASSIFICATION OF $h_{FE(2)}$

RANK	AD-BCP51-10, AD-BCP52-10, AD-BCP53-10	AD-BCP51-16, AD-BCP52-16, AD-BCP53-16
RANGE	63 ~ 160	100 ~ 250
MARKING	$\bar{B}CP51-10, \bar{B}CP52-10, \bar{B}CP53-10$	$\bar{B}CP51-16, \bar{B}CP52-16, \bar{B}CP53-16$

1) Maximum allowed temperature $T_j = 25^\circ\text{C}$.2) Measured with the device mounted on 1 inch² FR-4 board with 1oz. copper, in a still air environment with $T_a = 25^\circ\text{C}$.

TYPICAL CHARACTERISTICS

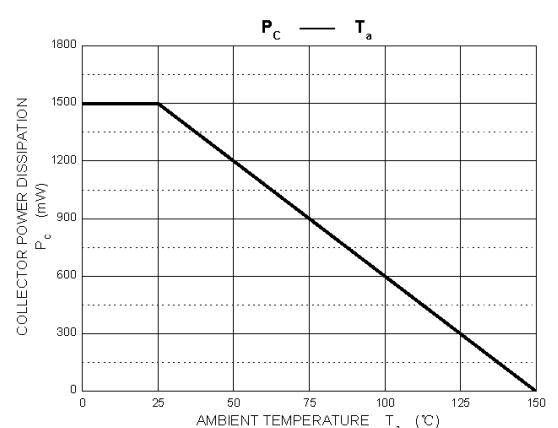
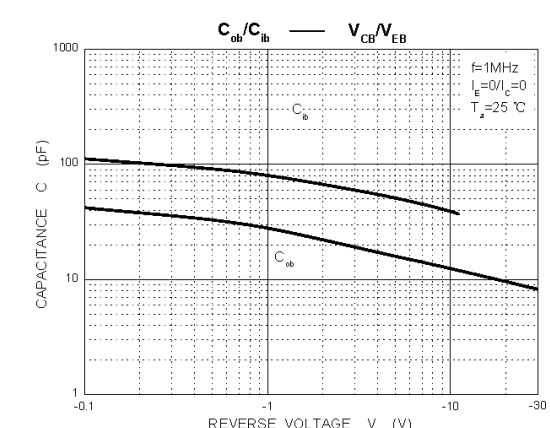
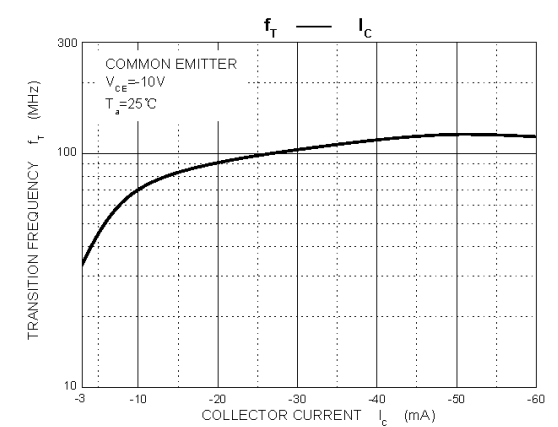
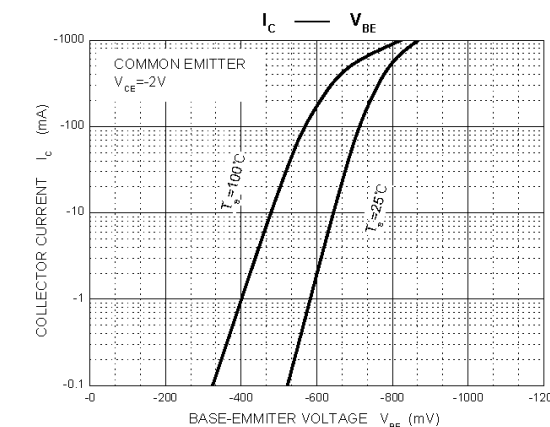
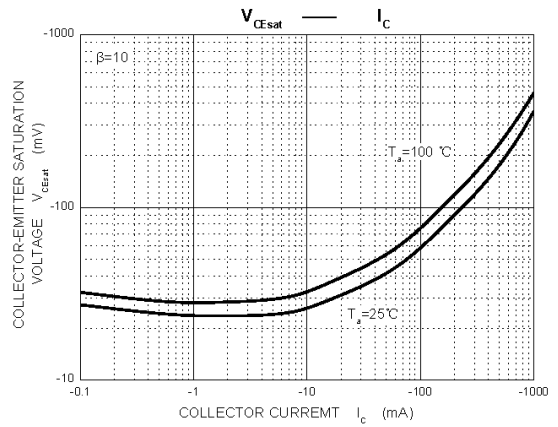
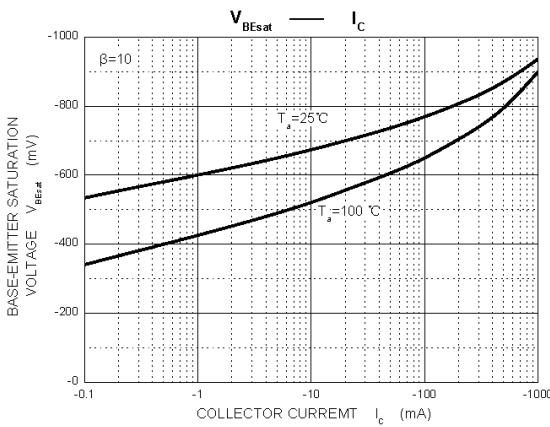
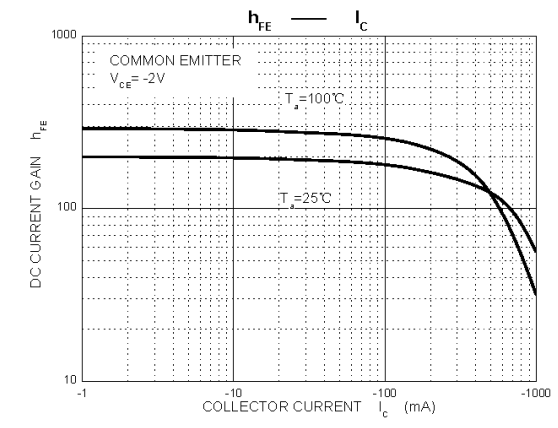
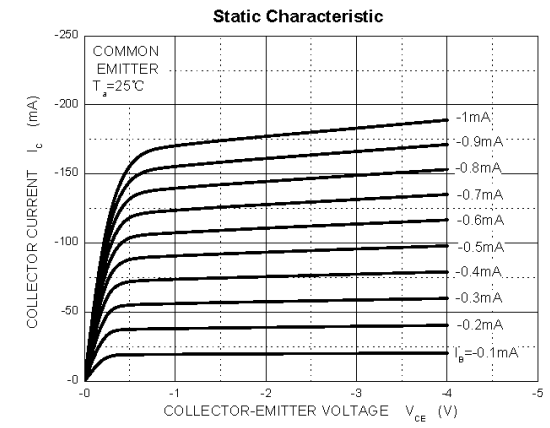

SOT-223 PACKAGE OUTLINE DIMENSIONS

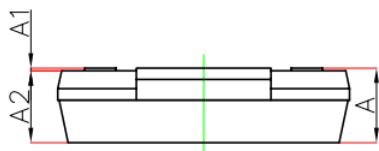
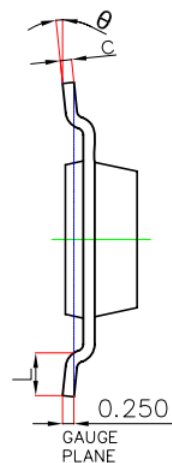
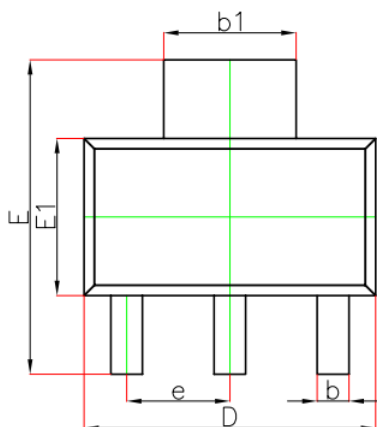

Symbol	Dimensions In Millimeters		Dimensions In Inches	
	Min.	Max.	Min.	Max.
A	—	1.800	—	0.071
A1	0.020	0.100	0.001	0.004
A2	1.500	1.700	0.059	0.067
b	0.660	0.840	0.026	0.033
b_1	2.900	3.100	0.114	0.122
c	0.230	0.350	0.009	0.014
D	6.300	6.700	0.248	0.264
E	6.700	7.300	0.264	0.287
E1	3.300	3.700	0.130	0.146
e	2.300(BSC)		0.091(BSC)	
L	0.750	—	0.030	—
θ	0°	10°	0°	10°

SOT-223 SUGGESTED PAD LAYOUT

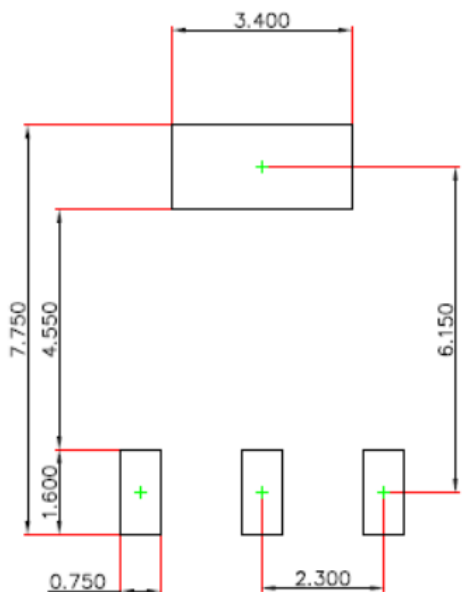

Note:

1. Controlling dimension in millimeters.
2. General tolerance: $\pm 0.05\text{mm}$.
3. The pad layout is for reference purpose only.

SOT-223 TAPE AND REEL

SOT-223 Embossed Carrier Tape

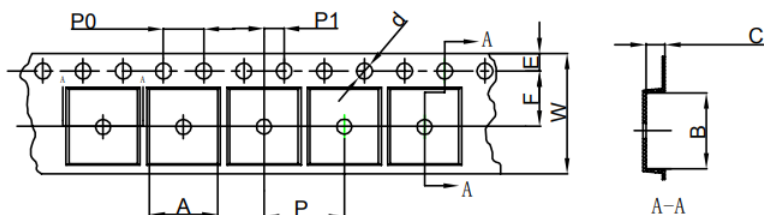

Packaging Description:
 SOT-223 parts are shipped in tape. The carrier tape is made from a dissipative (carbon filled) polycarbonate resin. The cover tape is a multilayer film (Heat Activated Adhesive in nature) primarily composed of polyester film, adhesive layer, sealant, and anti-static sprayed agent. These reeled parts in standard option are shipped with 2,500 units per 13" or 33.0cm diameter reel. The reels are clear in color and is made of polystyrene plastic (anti-static coated).

Dimensions are in millimeter										
Pkg type	A	B	C	d	E	F	P0	P	P1	W
SOT-223	6.765	7.335	1.88	Ø1.50	1.75	5.50	4.00	8.00	2.00	12.00

SOT-223 Tape Leader and Trailer

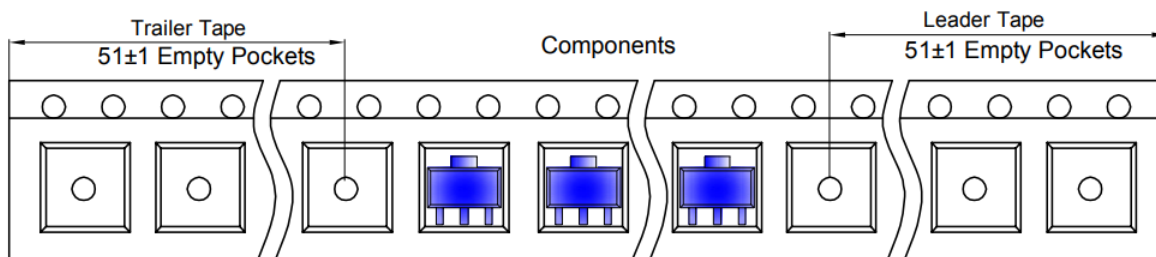

SOT-223 Reel

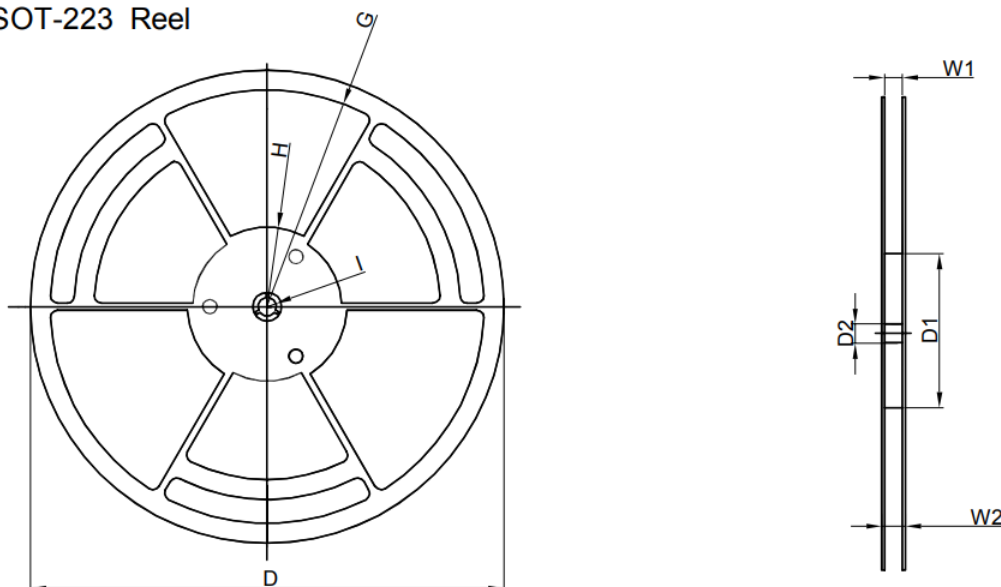

Dimensions are in millimeter								
Reel Option	D	D1	D2	G	H	I	W1	W2
13"Dia	Ø330.00	100.00	13.00	R151.00	R56.00	R6.50	12.40	17.60

REEL	Reel Size	Box	Box Size(mm)	Carton	Carton Size(mm)	G.W.(kg)
2,500 pcs	13 inch	2,500 pcs	336×336×48	20,000 pcs	445×355×365	

PUBLISHED BY**JIANGSU CHANGJING ELECTRONICS TECHNOLOGY CO., LTD.**

13th Floor, C Block, Tengfei Building, Yan Chuang Yuan, Nanjing Jiangbei New Area, China

LEGAL DISCLAIMER

The information given in this document shall in no event be regarded as a guarantee of conditions or characteristics. With respect to any examples, hints or typical values stated herein and/or any information regarding the application of the device, JSCJ hereby disclaims any and all warranties and liabilities of any kind, including without limitation, warranties of non-infringement of intellectual property rights of any third party.

In addition, any information given in this document is subject to customer's compliance with its obligations stated in this document and any applicable legal requirements, norms and standards concerning customer's products and any use of the product of JSCJ in customer's applications.

The data contained in this document is exclusively intended for technically trained staff. It is the responsibility of customer's technical departments to evaluate the suitability of the product for the intended application and the completeness of the product information given in this document with respect to such application.

INFORMATION

For further information on technology, delivery terms and conditions as well as prices, please contact your nearest JSCJ office (www.jscj-elec.com).

WARNINGS

Due to technical requirements, products may contain dangerous substances. For information on the types in question, please contact your nearest JSCJ office.

Except as otherwise explicitly approved by JSCJ in a written document signed by authorized representatives of JSCJ, JSCJ's products may not be used in any applications where a failure of the product or any consequences of the use thereof can reasonably be expected to result in personal injury.

X-ON Electronics

Largest Supplier of Electrical and Electronic Components

Click to view similar products for [Bipolar Transistors - BJT category:](#)

Click to view products by [Changjing Electronics Technology manufacturer:](#)

Other Similar products are found below :

[BC559C](#) [MCH4017-TL-H](#) [MMBT-2369-TR](#) [BC546/116](#) [NJVMJD148T4G](#) [NTE16](#) [NTE195A](#) [IMX9T110](#) [2N4401-A](#) [2N4403](#) [2N6728](#)
[2SA1419T-TD-H](#) [2SA2126-E](#) [2SB1204S-TL-E](#) [FMC5AT148](#) [2N2369ADCSM](#) [2N2907A](#) [2N3904-NS](#) [2N5769](#) [2SC4618TLN](#) [CPH6501-](#)
[TL-E](#) [MCH4021-TL-E](#) [Jantx2N5416](#) [US6T6TR](#) [BAX18/A52R](#) [BC556/112](#) [IMZ2AT108](#) [MMST8098T146](#) [UMX21NTR](#) [MCH6102-TL-E](#)
[TTA1452B,S4X\(S](#) [2N3879](#) [NTE13](#) [NTE282](#) [NTE323](#) [NTE350](#) [NTE81](#) [JANTX2N2920L](#) [JANTX2N3735](#) [JANSR2N2222AUB](#)
[CMLT3946EG TR](#) [SNSS40600CF8T1G](#) [CMLT3906EG TR](#) [GRP-DATA-JANS2N2907AUB](#) [GRP-DATA-JANS2N2222AUA](#)
[MMDT3946FL3-7](#) [2N4240](#) [JANS2N3019](#) [MSB30KH-13](#) [2N2221AUB](#)