

SOT-363 Plastic-Encapsulate Diodes

BAS70BRW /BAS70DW-04 /

BAS70DW-05 /BAS70DW-06 /BAS70TW

SCHOTTKY BARRIER DIODE ARRAYS

FEATURES

- Low Forward Voltage Drop
- Fast Switching
- Small Surface Mount Package
- PN Junction Guard Ring for Transient and ESD Protection
- Available in Lead Free Version

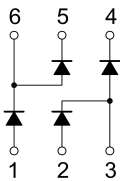
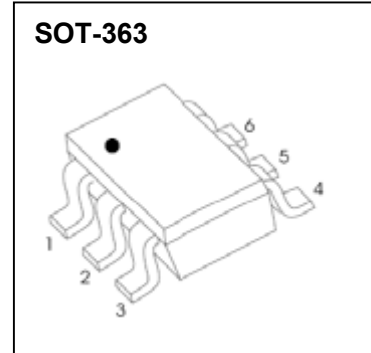

BAS70BRW

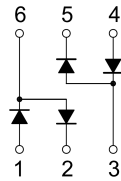

BAS70DW-04

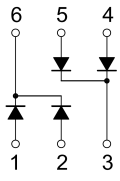

BAS70DW-05

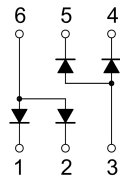



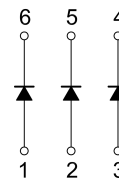

BAS70DW-06

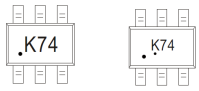

BAS70TW

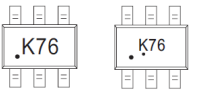
MARKING:

| BAS70BRW | BAS70DW-04 | BAS70DW-05 | BAS70DW-06 | BAS70TW |
|--|---|---|--|---|
|  |  |  |  |  |

Solid dot = Green molding compound device,if none, the normal device.

Solid dot = Pin1 indicate.

MAXIMUM RATINGS ($T_a=25^{\circ}\text{C}$ unless otherwise noted)

| Symbol | Parameter | Value | Unit |
|-----------------|--|----------|----------------------|
| V_{RRM} | Repetitive Peak Reverse Voltage | 70 | V |
| V_{RWM} | Peak Working Reverse Voltage | | |
| V_R | DC Blocking Voltage | | |
| $V_{R(RMS)}$ | RMS Reverse Voltage | 49 | V |
| I_o | Forward Continuous Current | 70 | mA |
| I_{FSM} | Non-repetitive Peak Forward Surge Current @ $t=8.3\text{ms}$ | 100 | mA |
| P_D | Power Dissipation | 200 | mW |
| $R_{\theta JA}$ | Thermal Resistance From Junction To Ambient | 500 | $^{\circ}\text{C/W}$ |
| T_j | Junction Temperature | 125 | $^{\circ}\text{C}$ |
| T_{stg} | Storage Temperature | -55~+150 | $^{\circ}\text{C}$ |

ELECTRICAL CHARACTERISTICS

$T_a=25\text{ }^\circ\text{C}$ unless otherwise specified

| Parameter | Symbol | Test conditions | Min | Typ | Max | Unit |
|-----------------------|------------|--|-----|-----|------|---------------|
| Reverse voltage | $V_{(BR)}$ | $I_R=10\mu\text{A}$ | 70 | | | V |
| Reverse current | I_R | $V_R=50\text{V}$ | | | 0.1 | μA |
| Forward voltage | V_F | $I_F=1\text{mA}$ | | | 0.41 | V |
| | | $I_F=15\text{mA}$ | | | 1 | |
| Total capacitance | C_{tot} | $V_R=0\text{V}, f=1\text{MHz}$ | | | 2 | pF |
| Reverse recovery time | t_{rr} | $I_F=I_R=10\text{mA}$ to $I_R=1\text{mA}, I_{rr}=0.1\times I_R, R_L=100\Omega$ | | | 5 | ns |

Typical Characteristics

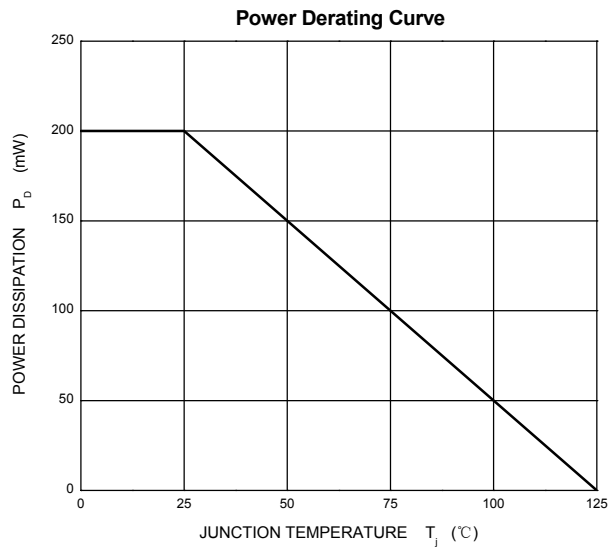
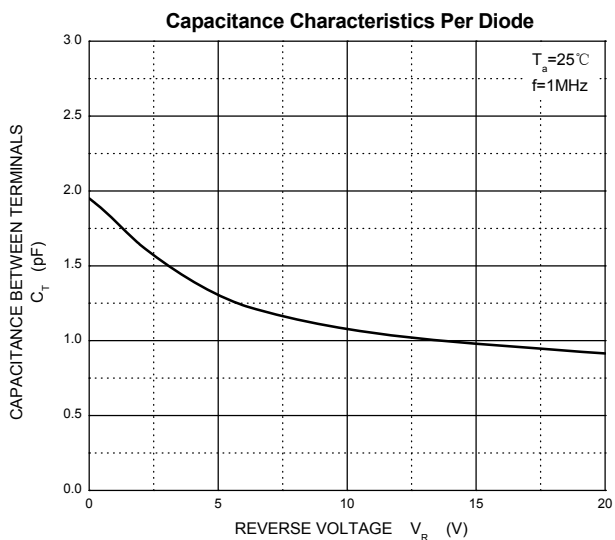
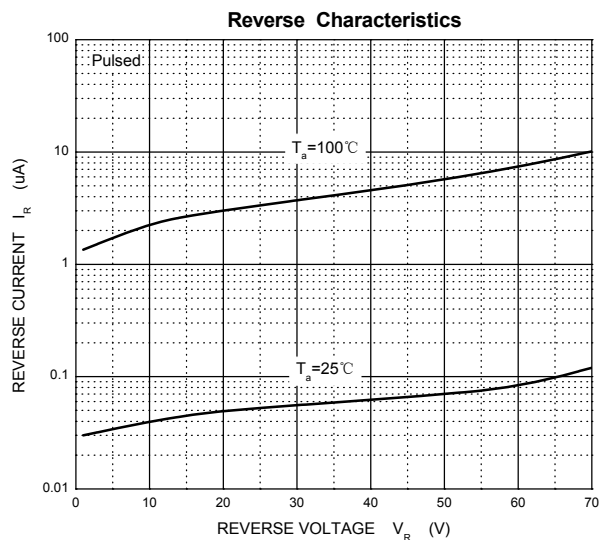
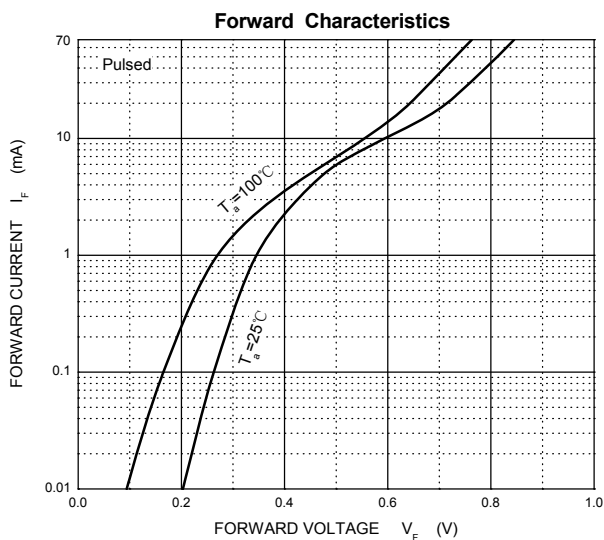

SOT-363 Package Outline Dimensions

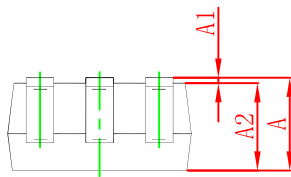
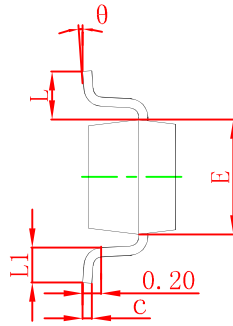
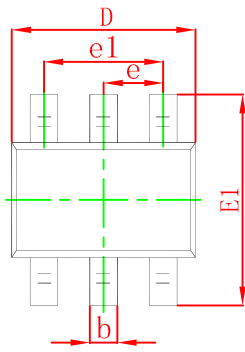

| Symbol | Dimensions In Millimeters | | Dimensions In Inches | |
|----------|---------------------------|-------|----------------------|-------|
| | Min | Max | Min | Max |
| A | 0.900 | 1.100 | 0.035 | 0.043 |
| A1 | 0.000 | 0.100 | 0.000 | 0.004 |
| A2 | 0.900 | 1.000 | 0.035 | 0.039 |
| b | 0.150 | 0.350 | 0.006 | 0.014 |
| c | 0.100 | 0.150 | 0.004 | 0.006 |
| D | 2.000 | 2.200 | 0.079 | 0.087 |
| E | 1.150 | 1.350 | 0.045 | 0.053 |
| E1 | 2.150 | 2.400 | 0.085 | 0.094 |
| e | 0.650 TYP | | 0.026 TYP | |
| e1 | 1.200 | 1.400 | 0.047 | 0.055 |
| L | 0.525 REF | | 0.021 REF | |
| L1 | 0.260 | 0.460 | 0.010 | 0.018 |
| θ | 0° | 8° | 0° | 8° |

SOT-363 Suggested Pad Layout

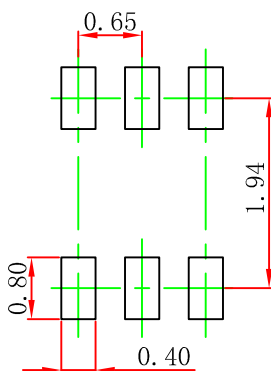

Note:

1. Controlling dimension: in millimeters.
2. General tolerance: $\pm 0.05\text{mm}$.
3. The pad layout is for reference purposes only.

NOTICE

JCET reserve the right to make modifications, enhancements, improvements, corrections or other changes without further notice to any product herein. JCET does not assume any liability arising out of the application or use of any product described herein.

SOT-363 Embossed Carrier Tape

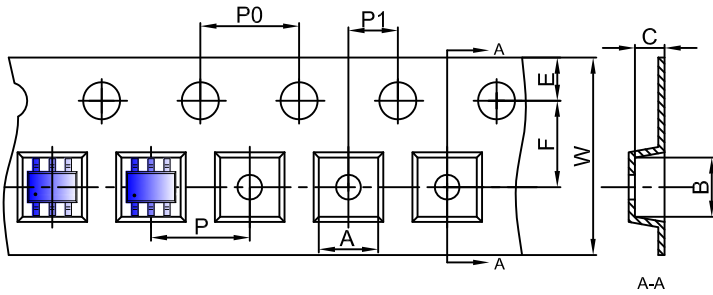

Packaging Description:

SOT-363 parts are shipped in tape. The carrier tape is made from a dissipative (carbon filled) polycarbonate resin. The cover tape is a multilayer film (Heat Activated Adhesive in nature) primarily composed of polyester film, adhesive layer, sealant, and anti-static sprayed agent. These reeled parts in standard option are shipped with 3,000 units per 7" or 17.8cm diameter reel. The reels are clear in color and is made of polystyrene plastic (anti-static coated).

| Dimensions are in millimeter | | | | | | | | | | |
|------------------------------|------|------|------|-------|------|------|------|------|------|------|
| Pkg type | A | B | C | d | E | F | P0 | P | P1 | W |
| SOT-363 | 2.25 | 2.55 | 1.20 | Ø1.50 | 1.75 | 3.50 | 4.00 | 4.00 | 2.00 | 8.00 |

SOT-363 Tape Leader and Trailer

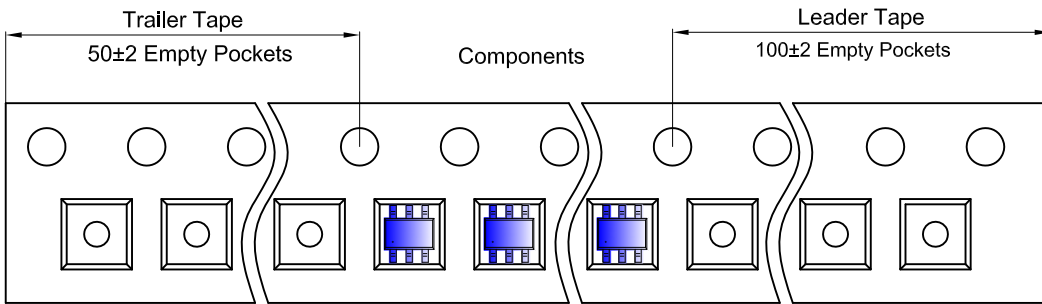

SOT-363 Reel

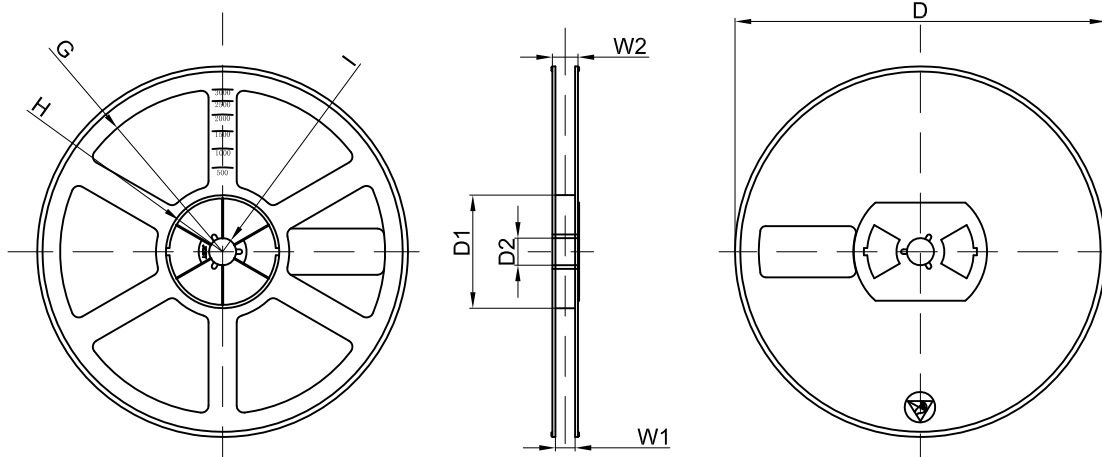

| Dimensions are in millimeter | | | | | | | | |
|------------------------------|---------|-------|-------|--------|--------|-------|------|-------|
| Reel Option | D | D1 | D2 | G | H | I | W1 | W2 |
| 7" Dia | Ø178.00 | 54.40 | 13.00 | R78.00 | R25.60 | R6.50 | 9.50 | 12.30 |

| REEL | Reel Size | Box | Box Size(mm) | Carton | Carton Size(mm) | G.W.(kg) |
|----------|-----------|------------|--------------|-------------|-----------------|----------|
| 3000 pcs | 7 inch | 45,000 pcs | 203×203×195 | 180,000 pcs | 438×438×220 | |

X-ON Electronics

Largest Supplier of Electrical and Electronic Components

Click to view similar products for [Schottky Diodes & Rectifiers](#) category:

Click to view products by [Changjing Electronics Technology](#) manufacturer:

Other Similar products are found below :

[MA4E2508M-1112](#) [MBR0530L-TP](#) [MBR10100CT-BP](#) [MBR1545CT](#) [MMBD301M3T5G](#) [RB160M-50TR](#) [BAS16E6433HTMA1](#) [BAS3010S-02LRH E6327](#) [BAT 54-02LRH E6327](#) [IDL02G65C5XUMA1](#) [NSR05F40QNXT5G](#) [NTE555](#) [JANS1N6640](#) [SB07-03C-TB-H](#) [SBS818-TL-E](#) [SK310-T](#) [SK34B-TP](#) [SS3003CH-TL-E](#) [PDS3100Q-7](#) [GA01SHT18](#) [CRS10I30A\(TE85L,QM](#) [MA4E2501L-1290](#) [MBRB30H30CT-1G](#) [JANTX1N5712-1](#) [SB007-03C-TB-E](#) [SK33B-TP](#) [SK35A-TP](#) [SK38B-LTP](#) [NTE505](#) [NTSB30U100CT-1G](#) [VS-6CWQ10FNHM3](#) [CRG04\(T5L,TEMQ\)](#) [ACDBA1100LR-HF](#) [ACDBA1200-HF](#) [ACDBA240-HF](#) [ACDBA3100-HF](#) [CDBQC0530L-HF](#) [ACDBA260LR-HF](#) [ACDBA1100-HF](#) [MA4E2502L-1246](#) [10BQ015-M3/5BT](#) [NRVB130LSFT1G](#) [CRS08TE85LQM](#) [PMAD1108-LF](#) [B120Q-13-F](#) [1N5819T-G](#) [B0530WSQ-7-F](#) [PDS1040Q-13](#) [B160BQ-13-F](#) [B140S1F-7](#)