

TO-92 Plastic-Encapsulate Transistors

BC635 / BC637 / BC639 TRANSISTOR (NPN)

FEATURES

High current transistors

MARKING

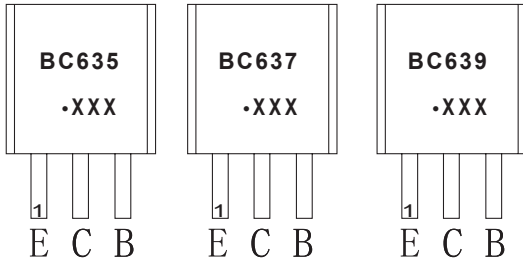

BC635,BC637,BC639=Device code

Solid dot=Green molding compound device,
if none,the normal device

XXX=Code

ORDERING INFORMATION

| Part Number | Package | Packing Method | Pack Quantity |
|-------------|---------|----------------|---------------|
| BC635 | TO-92 | Bulk | 1000pcs/Bag |
| BC635-TA | TO-92 | Tape | 2000pcs/Box |
| BC637 | TO-92 | Bulk | 1000pcs/Bag |
| BC637-TA | TO-92 | Tape | 2000pcs/Box |
| BC639 | TO-92 | Bulk | 1000pcs/Bag |
| BC639-TA | TO-92 | Tape | 2000pcs/Box |

MAXIMUM RATINGS (T_a=25°C unless otherwise noted)

| Symbol | Parameter | Value | Unit |
|----------------------------------|--|----------|------|
| V _{CB0} | Collector-Emitter Voltage | BC635 | 45 |
| | | BC637 | 60 |
| | | BC639 | 100 |
| V _{CE0} | Collector-Emitter Voltage | BC635 | 45 |
| | | BC637 | 60 |
| | | BC639 | 80 |
| V _{EB0} | Emitter-Base Voltage | 5 | V |
| I _c | Collector Current -Continuous | 1 | A |
| P _c | Collector Power Dissipation | 0.83 | W |
| T _J ,T _{stg} | Operation Junction and Storage Temperature Range | -55~+150 | °C |

TO-92

1. EMITTER
2. COLLECTOR
3. BASE

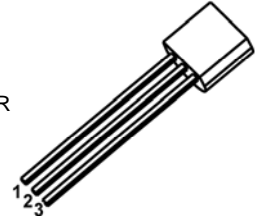

Equivalent Circuit

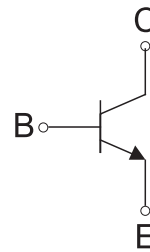

ELECTRICAL CHARACTERISTICS

$T_a=25^\circ\text{C}$ unless otherwise specified

| Parameter | Symbol | Test conditions | Min | Typ | Max | Unit |
|--------------------------------------|---------------|---|-----|-----|-----|---------------|
| Collector-emitter breakdown voltage | $V_{(BR)CEO}$ | $I_C=10\text{mA}, I_B=0$ BC635 | 45 | | | V |
| | | BC637 | 60 | | | V |
| | | BC639 | 80 | | | V |
| Collector cut-off current | I_{CBO} | $V_{CB}=30\text{V}, I_E=0$ | | | 0.1 | μA |
| Emitter cut-off current | I_{EBO} | $V_{EB}=5\text{V}, I_B=0$ | | | 0.1 | μA |
| DC current gain | $h_{FE(1)}$ | $V_{CE}=2\text{V}, I_C=5\text{mA}$ | 25 | | | |
| | $h_{FE(2)}$ | $V_{CE}=2\text{V}, I_C=150\text{mA}$ BC635 | 40 | | 250 | |
| | | BC637-10/BC639-10 | 63 | | 160 | |
| | | BC637-16/BC639-16 | 100 | | 250 | |
| | $h_{FE(3)}$ | $V_{CE}=2\text{V}, I_C=500\text{mA}$ | 25 | | | |
| Collector-emitter saturation voltage | $V_{CE(sat)}$ | $I_C=500\text{mA}, I_B=50\text{mA}$ | | | 0.5 | V |
| Base-emitter voltage | V_{BE} | $V_{CE}=2\text{V}, I_C=500\text{mA}$ | | | 1 | V |
| Transition frequency | f_T | $V_{CE}=5\text{V}, I_C=10\text{mA}, f=50\text{MHz}$ | | 100 | | MHz |

Typical Characteristics

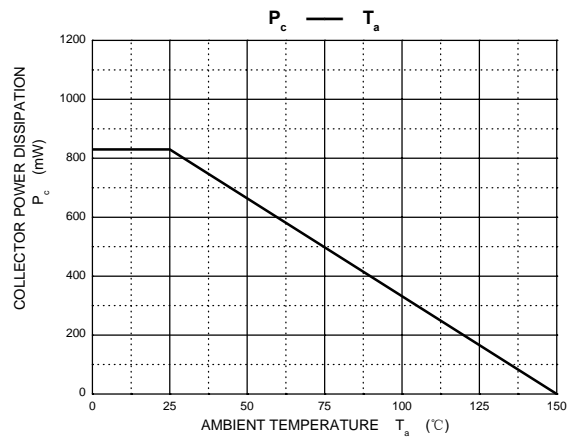
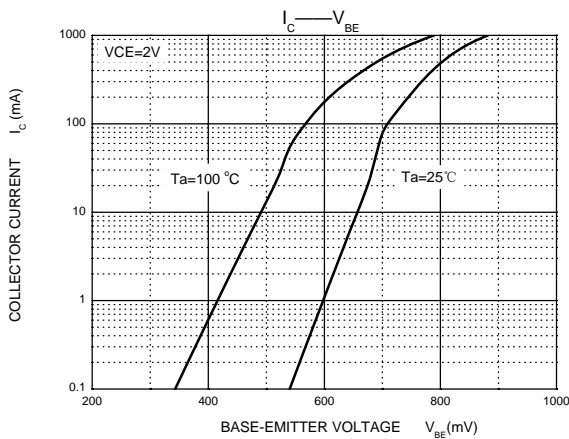
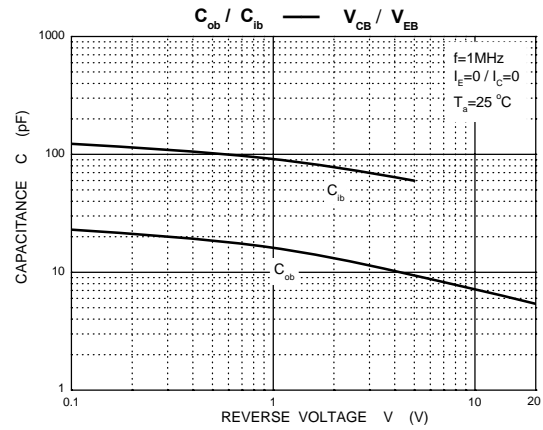
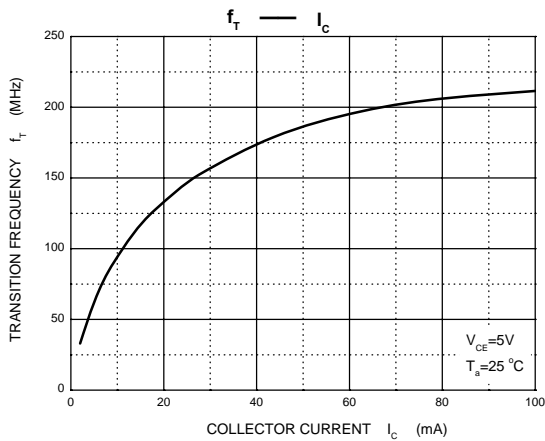
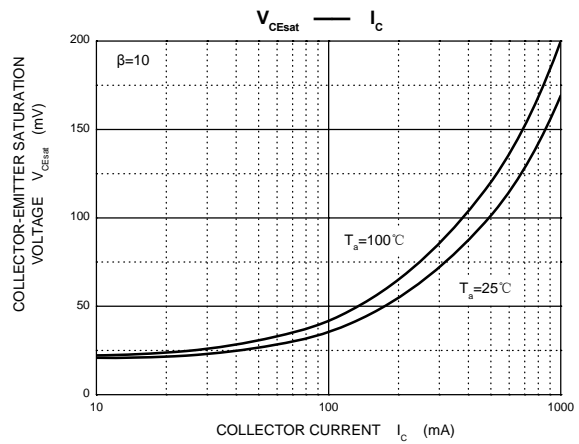
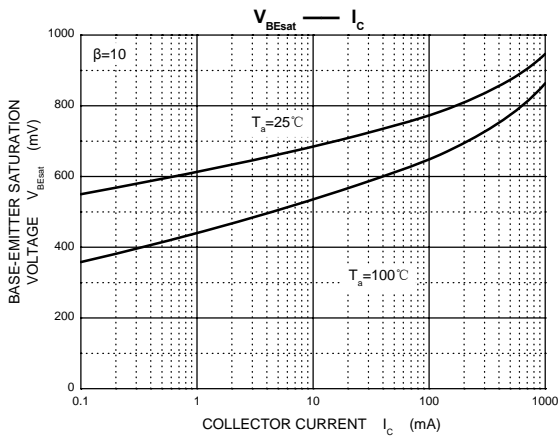
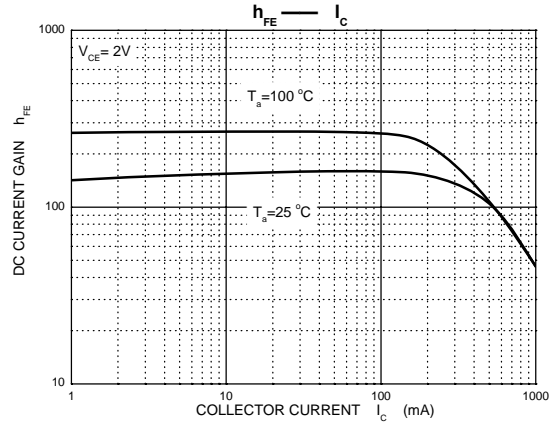
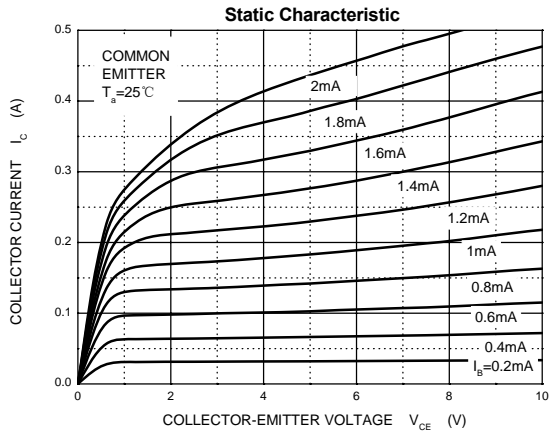

TO-92 Package Outline Dimensions

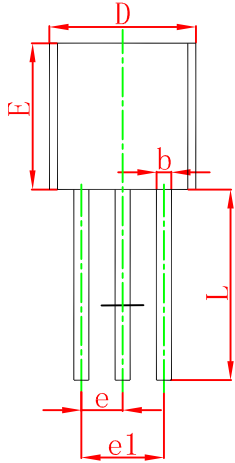
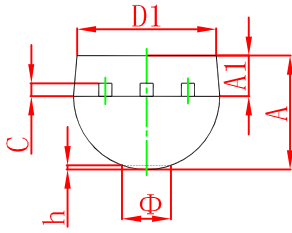

| Symbol | Dimensions In Millimeters | | Dimensions In Inches | |
|--------|---------------------------|--------|----------------------|-------|
| | Min | Max | Min | Max |
| A | 3.300 | 3.700 | 0.130 | 0.146 |
| A1 | 1.100 | 1.400 | 0.043 | 0.055 |
| b | 0.380 | 0.550 | 0.015 | 0.022 |
| c | 0.360 | 0.510 | 0.014 | 0.020 |
| D | 4.300 | 4.700 | 0.169 | 0.185 |
| D1 | 3.430 | | 0.135 | |
| E | 4.300 | 4.700 | 0.169 | 0.185 |
| e | 1.270 TYP | | 0.050 TYP | |
| e1 | 2.440 | 2.640 | 0.096 | 0.104 |
| L | 14.100 | 14.500 | 0.555 | 0.571 |
| Φ | | 1.600 | | 0.063 |
| h | 0.000 | 0.380 | 0.000 | 0.015 |

TO-92 Suggested Pad Layout

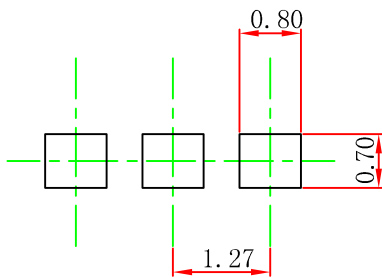

Note:

1. Controlling dimension: in millimeters.
2. General tolerance: $\pm 0.05\text{mm}$.
3. The pad layout is for reference purposes only.

NOTICE

JSCJ reserves the right to make modifications, enhancements, improvements, corrections or other changes without further notice to any product herein. JSCJ does not assume any liability arising out of the application or use of any product described herein.

TO-92 PACKAGE TAPING DIMENSION

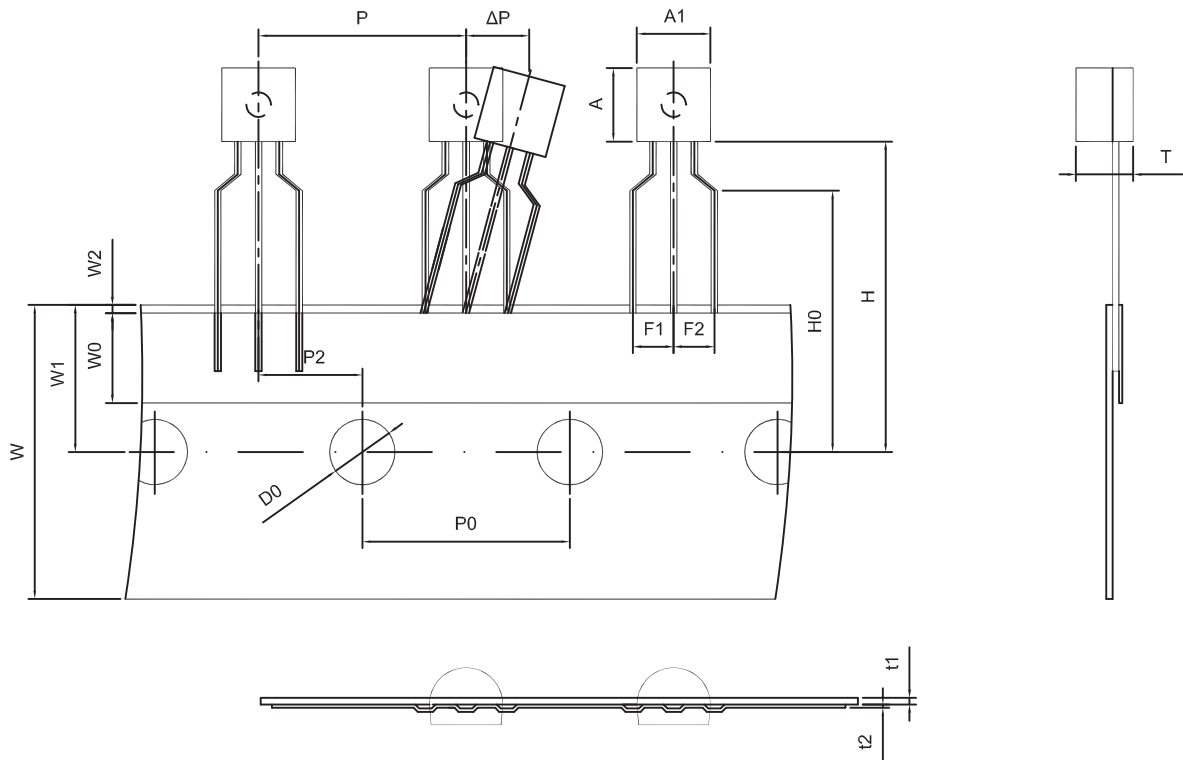

Dimensions are in millimeter

| | | | | | | | | |
|-----|-----|----------|------|------|------|-----|-----|------|
| A1 | A | T | P | P0 | P2 | F1 | F2 | W |
| 4.5 | 4.5 | 3.5 | 12.7 | 12.7 | 6.35 | 2.5 | 2.5 | 18.0 |
| W0 | W1 | W2 | H | H0 | D0 | t1 | t2 | ΔP |
| 6.0 | 9.0 | 1.0 MAX. | 19.0 | 16.0 | 4.0 | 0.4 | 0.2 | 0 |

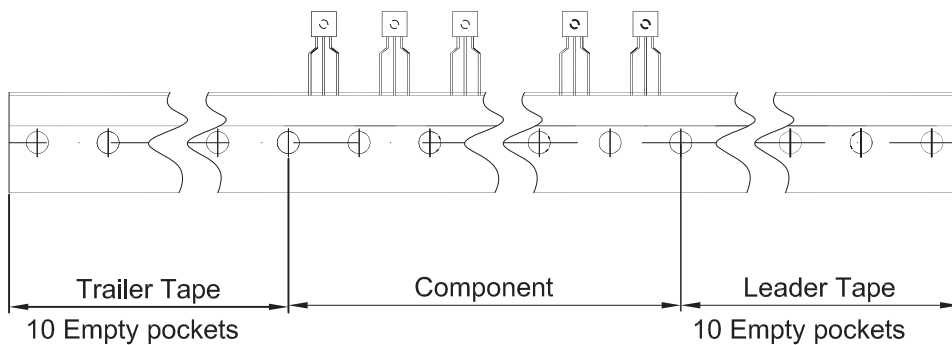

| | | | | |
|---------|----------|--------------|------------|-----------------|
| Package | Box | Box Size(mm) | Carton | Carton Size(mm) |
| TO-92 | 2000 pcs | 333×162×43 | 20,000 pcs | 350×340×250 |

X-ON Electronics

Largest Supplier of Electrical and Electronic Components

Click to view similar products for [Bipolar Transistors - BJT category](#):

Click to view products by [Changjing Electronics Technology manufacturer](#):

Other Similar products are found below :

[BC559C](#) [MCH4017-TL-H](#) [MMBT-2369-TR](#) [BC546/116](#) [NJVMJD148T4G](#) [NTE16](#) [NTE195A](#) [IMX9T110](#) [2N4401-A](#) [2N6728](#) [2SA1419T-TD-H](#) [2SB1204S-TL-E](#) [2SC5488A-TL-H](#) [FMC5AT148](#) [2N2369ADCSM](#) [2N2907A](#) [2N3904-NS](#) [2N5769](#) [2SC4618TLN](#) [CPH6501-TL-E](#) [US6T6TR](#) [BAX18/A52R](#) [BC556/112](#) [IMZ2AT108](#) [MMST8098T146](#) [MCH6102-TL-E](#) [BC846B-13-F](#) [2N3879](#) [30A02MH-TL-E](#) [NTE13](#) [NTE282](#) [NTE323](#) [NTE350](#) [NTE81](#) [JANTX2N2920L](#) [JANSR2N2907AUB](#) [CMLT3946EG TR](#) [SNSS40600CF8T1G](#) [CMLT3906EG TR](#) [GRP-DATA-JANS2N2907AUB](#) [GRP-DATA-JANS2N2222AUA](#) [MMDT3946FL3-7](#) [2N4240](#) [JANS2N3019](#) [MSB30KH-13](#) [2N2221AUB](#) [2SD1815T-TL-E](#) [2N6678](#) [2N2907Ae4](#) [JAN2N3507](#)