

SOT-363 Plastic-Encapsulate Transistors

BC847PN DUAL TRANSISTOR (NPN+PNP)

FEATURES

- Epitaxial Die Construction
- Two isolated NPN/PNP(BC847W+BC857W) Transistors in one package

MAKING: 7P

MAXIMUM RATINGS TR1 (T_a=25°C unless otherwise noted)

Symbol	Parameter	Value	Units
V _{CB0}	Collector-Base Voltage	50	V
V _{CEO}	Collector-Emitter Voltage	45	V
V _{EBO}	Emitter-Base Voltage	6	V
I _c	Collector Current –Continuous	0.1	A
P _c	Collector Power Dissipation	200	mW
T _J , T _{stg}	Operation Junction and Storage Temperature Range	-55~+150	°C

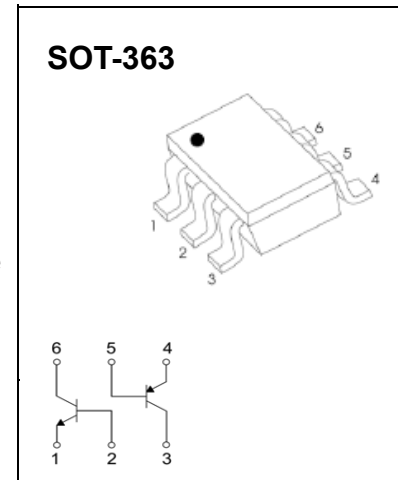

CHARACTERISTICS of TR1 (NPN Transistor) (T_a=25°C unless otherwise specified)

Parameter	Symbol	Test conditions	Min	Typ	Max	Unit
Collector-base breakdown voltage	V _{(BR)CBO}	I _C =10μA, I _E =0	50			V
Collector-emitter breakdown voltage	V _{(BR)CEO}	I _C =10mA, I _B =0	45			V
Emitter-base breakdown voltage	V _{(BR)EBO}	I _E =1μA, I _C =0	6			V
Collector cut-off current	I _{CBO}	V _{CB} =30V, I _E =0			15	nA
Emitter cut-off current	I _{EBO}	V _{EB} =5V, I _C =0			15	nA
DC current gain	h _{FE}	V _{CE} =5V, I _C =2mA	200		450	
Collector-emitter saturation voltage	V _{CE(sat)}	I _C =10mA, I _B =0.5mA			0.25	V
	V _{CE(sat)}	I _C =100mA, I _B =5mA			0.6	V
Base-emitter saturation voltage	V _{BE(sat)}	I _C =10mA, I _B =0.5mA		0.7		V
	V _{BE(sat)}	I _C =100mA, I _B =5mA		0.9		V
Base-emitter voltage	V _{BE(on)}	V _{CE} =5V, I _C =2mA	0.58		0.7	V
	V _{BE(on)}	V _{CE} =5V, I _C =10mA			0.72	V
Collector output capacitance	C _{ob}	V _{CB} =10V, I _E =0, f=1MHz			6.0	pF
Transition frequency	f _T	V _{CE} =5V, I _C =10mA, f=100MHz	100			MHz
Noise figure	NF	V _{CE} =5V, I _C =0.2mA, f=1kHz, R _g =2KΩ, Δf=200Hz			10	dB

MAXIMUM RATINGS TR2 (T_a=25°C unless otherwise noted)

Symbol	Parameter	Value	Units
V _{CB0}	Collector-Base Voltage	-50	V
V _{CE0}	Collector-Emitter Voltage	-45	V
V _{EBO}	Emitter-Base Voltage	-5	V
I _c	Collector Current –Continuous	-0.1	A
P _{C*}	Collector Power Dissipation	200	mW
T _J , T _{stg}	Operation Junction and Storage Temperature Range	-55~+150	°C

CHARACTERISTICS of TR2 (PNP Transistor) (T_a=25°C unless otherwise specified)

Parameter	Symbol	Test conditions	MIN	TYP	MAX	UNIT
Collector-base breakdown voltage	V _{(BR)CBO}	I _C =-10μA, I _E =0	-50			V
Collector-emitter breakdown voltage	V _{(BR)CEO}	I _C =-10mA, I _B =0	-45			V
Emitter-base breakdown voltage	V _{(BR)EBO}	I _E =-1μA, I _C =0	-5			V
Collector cut-off current	I _{CBO}	V _{CB} =-30V, I _E =0			-15	nA
Emitter cut-off current	I _{EBO}	V _{EB} =-5V, I _C =0			-15	nA
DC current gain	h _{FE1}	V _{CE} =-5V, I _C =-2mA	220		475	
Collector-emitter saturation voltage	V _{CE(sat)}	I _C =-10mA, I _B =-0.5mA			-0.3	V
	V _{CE(sat)}	I _C =-100mA, I _B =-5mA			-0.65	V
Base-emitter saturation voltage	V _{BE(sat)}	I _C =-10mA, I _B =-0.5mA		-0.7		V
	V _{BE(sat)}	I _C =-100mA, I _B =-5mA			-0.95	V
Base-emitter voltage	V _{BE(on)}	V _{CE} =-5V, I _C =-2mA	-0.6		-0.75	V
	V _{BE(on)}	V _{CE} =-5V, I _C =-10mA			-0.82	V
Collector output capacitance	C _{ob}	V _{CB} =-10V, I _E =0, f=1MHz			4.5	pF
Transition frequency	f _T	V _{CE} =-5V, I _C =-10mA, f=100MHz	100			MHz
Noise figure	NF	V _{CE} =-5V, I _c =-0.2mA, f=1kHz, R _g =2KΩ, Δf=200Hz			10	dB

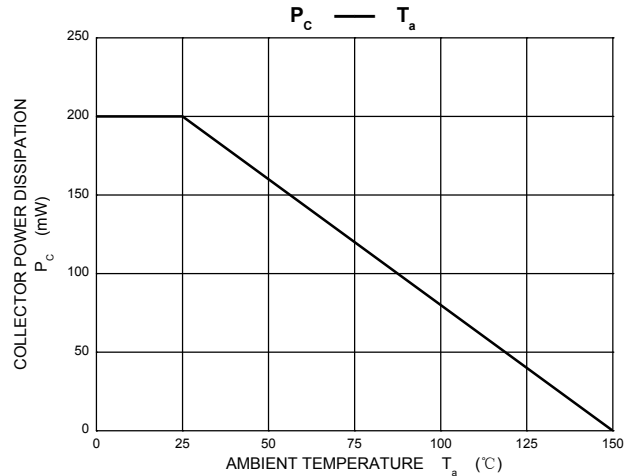
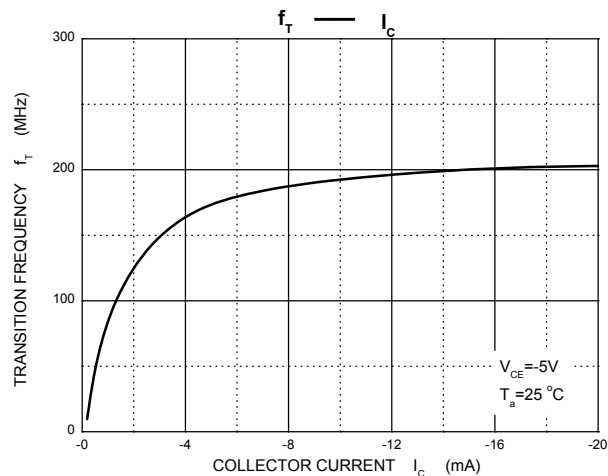
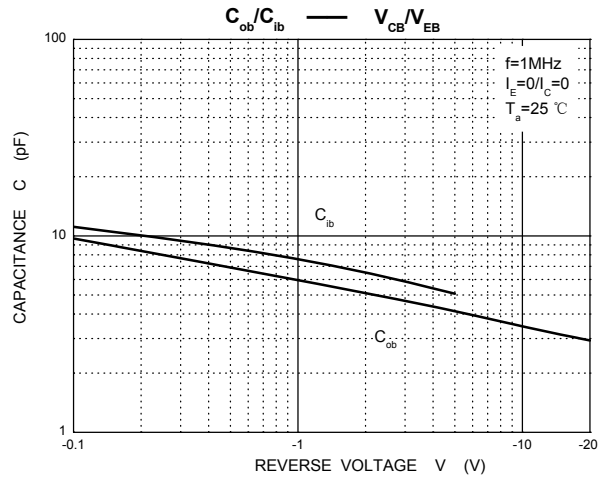
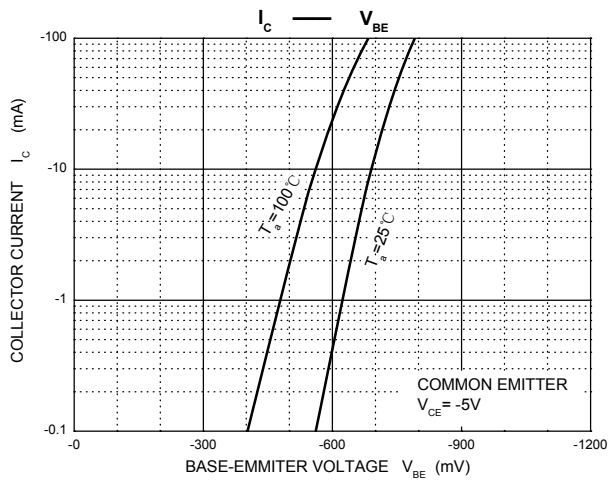
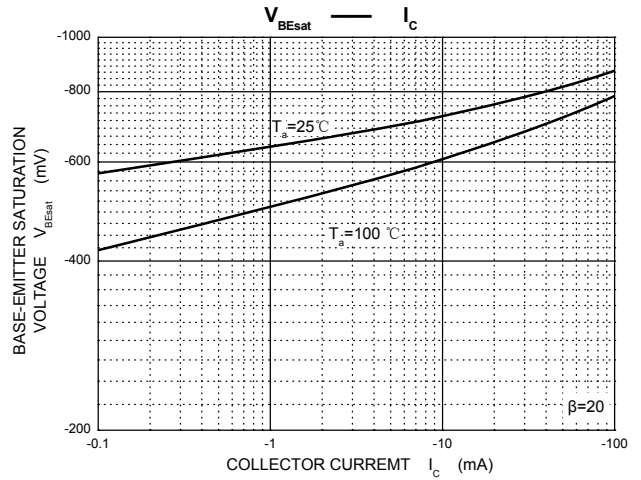
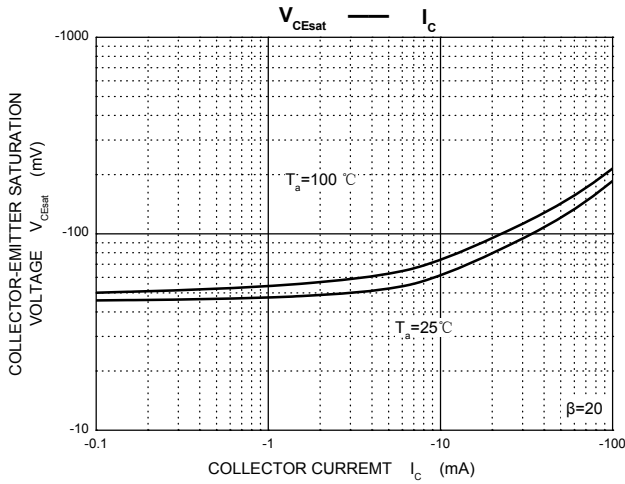
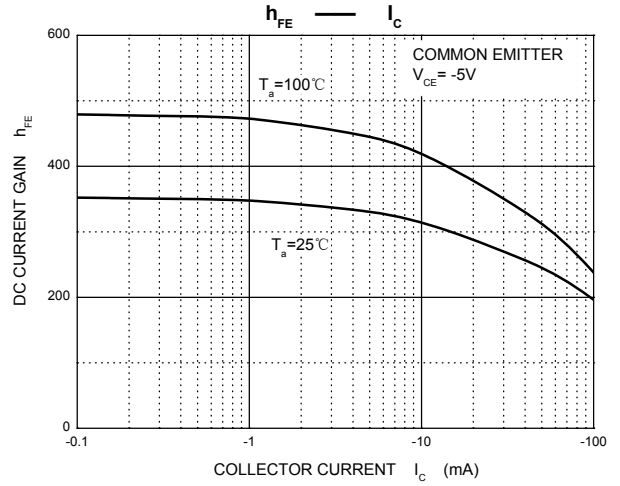
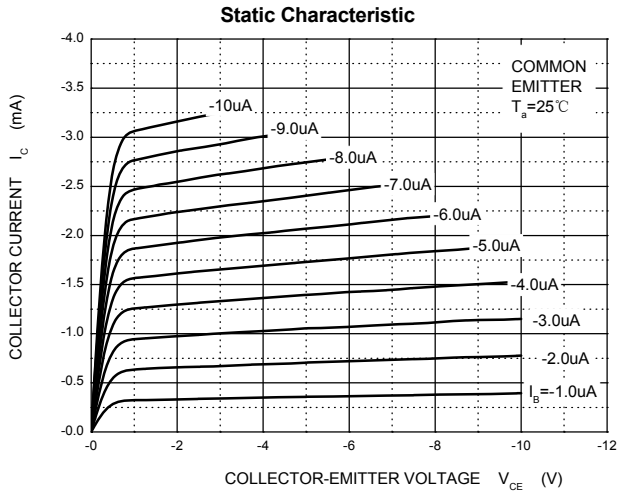

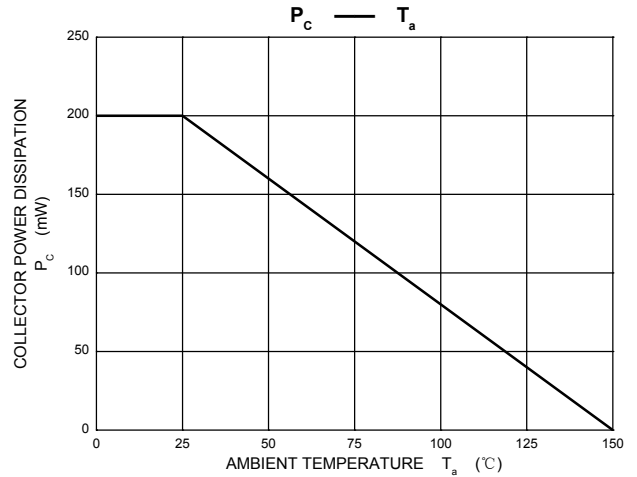
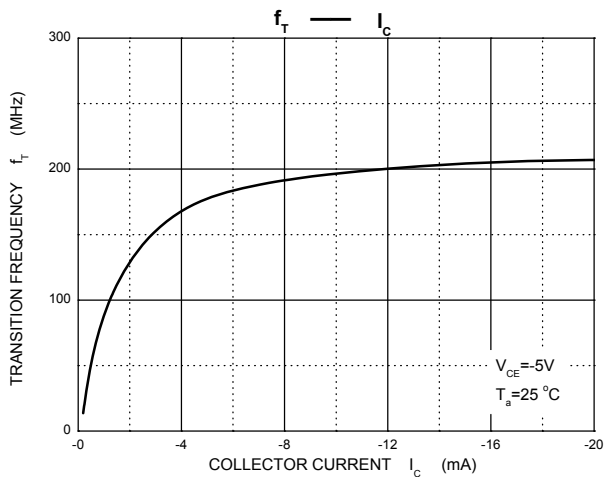
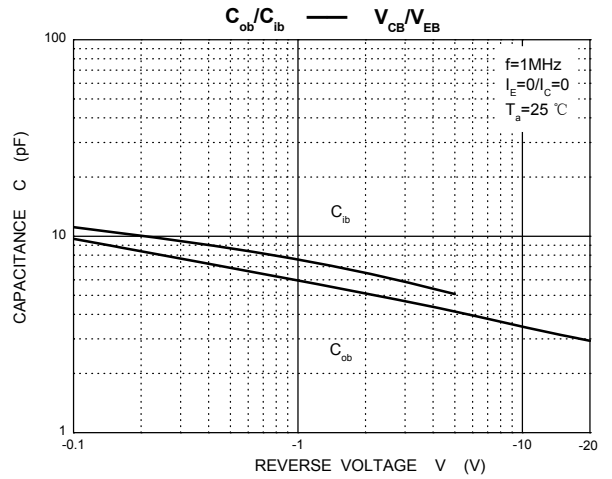
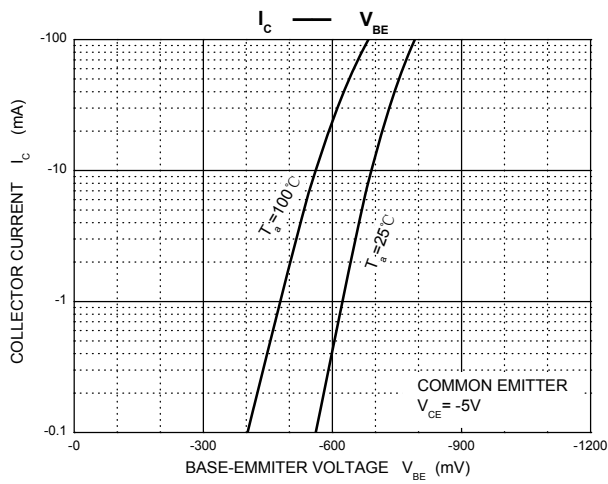
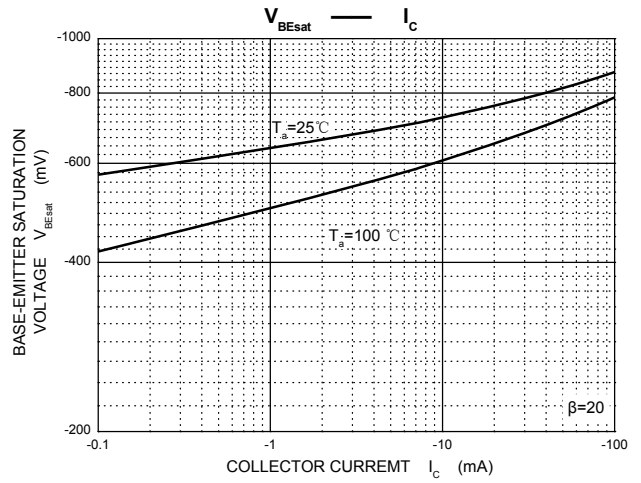
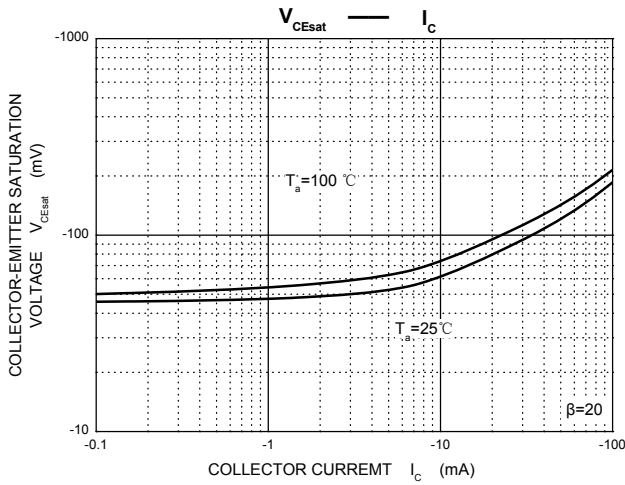
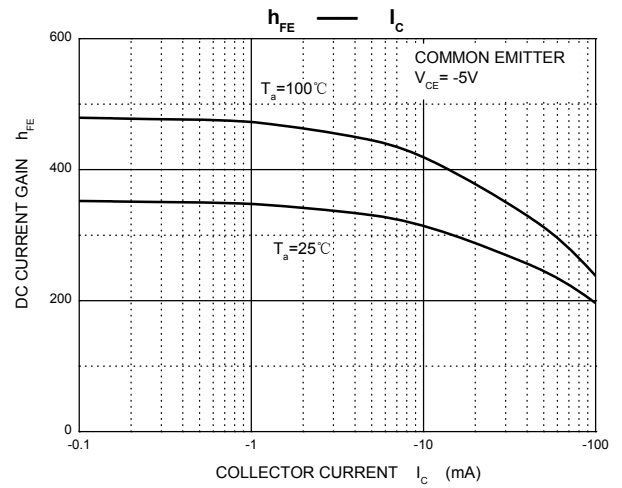
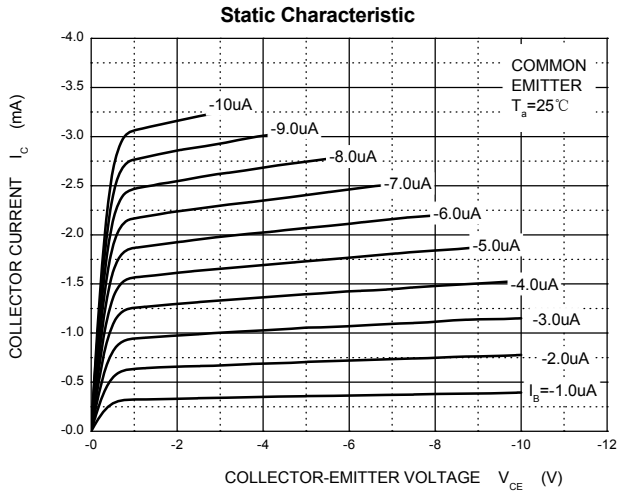

SOT-363 Package Outline Dimensions

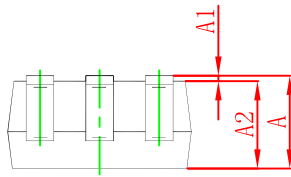
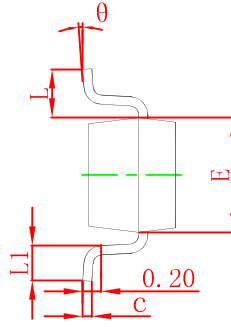
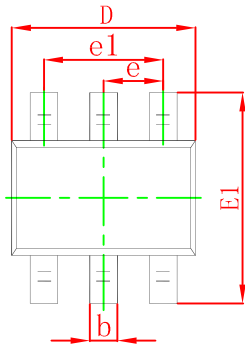

Symbol	Dimensions In Millimeters		Dimensions In Inches	
	Min	Max	Min	Max
A	0.900	1.100	0.035	0.043
A1	0.000	0.100	0.000	0.004
A2	0.900	1.000	0.035	0.039
b	0.150	0.350	0.006	0.014
c	0.100	0.150	0.004	0.006
D	2.000	2.200	0.079	0.087
E	1.150	1.350	0.045	0.053
E1	2.150	2.400	0.085	0.094
e	0.650 TYP		0.026 TYP	
e1	1.200	1.400	0.047	0.055
L	0.525 REF		0.021 REF	
L1	0.260	0.460	0.010	0.018
theta	0°	8°	0°	8°

SOT-363 Suggested Pad Layout

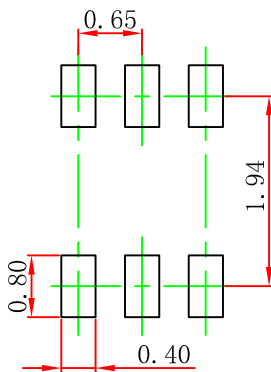

Note:

1. Controlling dimension: in millimeters.
2. General tolerance: $\pm 0.05\text{mm}$.
3. The pad layout is for reference purposes only.

NOTICE

JSCJ reserves the right to make modifications, enhancements, improvements, corrections or other changes without further notice to any product herein. JSCJ does not assume any liability arising out of the application or use of any product described herein.

SOT-363 Embossed Carrier Tape

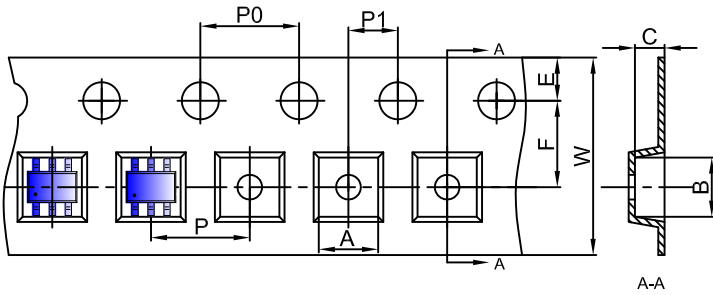

Packaging Description:

SOT-363 parts are shipped in tape. The carrier tape is made from a dissipative (carbon filled) polycarbonate resin. The cover tape is a multilayer film (Heat Activated Adhesive in nature) primarily composed of polyester film, adhesive layer, sealant, and anti-static sprayed agent. These reeled parts in standard option are shipped with 3,000 units per 7" or 17.8cm diameter reel. The reels are clear in color and is made of polystyrene plastic (anti-static coated).

Dimensions are in millimeter										
Pkg type	A	B	C	d	E	F	P0	P	P1	W
SOT-363	2.25	2.55	1.20	Ø1.50	1.75	3.50	4.00	4.00	2.00	8.00

SOT-363 Tape Leader and Trailer

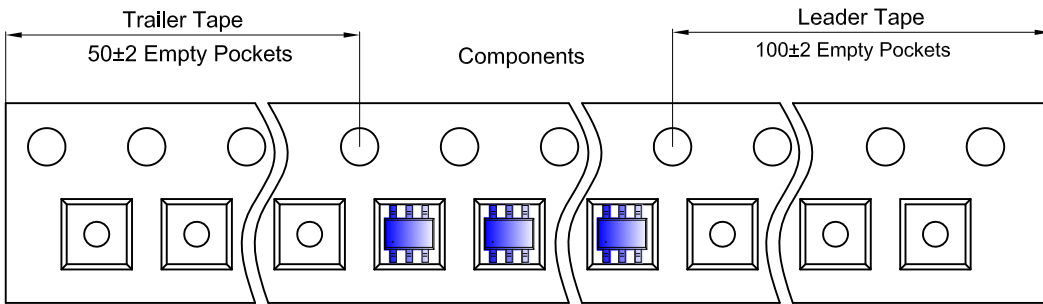

SOT-363 Reel

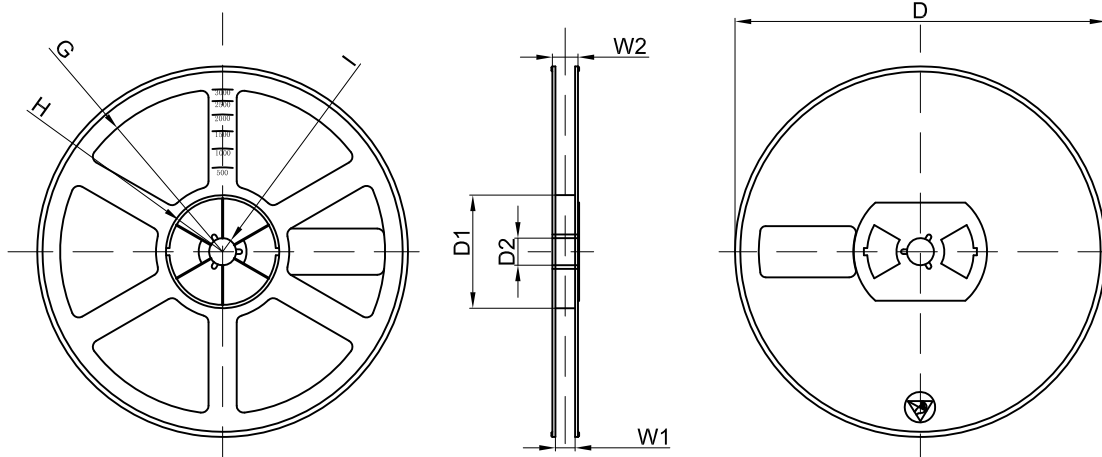

Dimensions are in millimeter								
Reel Option	D	D1	D2	G	H	I	W1	W2
7"Dia	Ø178.00	54.40	13.00	R78.00	R25.60	R6.50	9.50	12.30

REEL	Reel Size	Box	Box Size(mm)	Carton	Carton Size(mm)	G.W.(kg)
3000 pcs	7 inch	45,000 pcs	203×203×195	180,000 pcs	438×438×220	

X-ON Electronics

Largest Supplier of Electrical and Electronic Components

Click to view similar products for [Bipolar Transistors - BJT category](#):

Click to view products by [Changjing Electronics Technology manufacturer](#):

Other Similar products are found below :

[619691C](#) [MCH4017-TL-H](#) [MMBT-2369-TR](#) [BC546/116](#) [BC557/116](#) [BSW67A](#) [NJVMJD148T4G](#) [NTE123AP-10](#) [NTE153MCP](#) [NTE16](#)
[NTE195A](#) [NTE92](#) [C4460](#) [2N4401-A](#) [2N6728](#) [2SA1419T-TD-H](#) [2SA2126-E](#) [2SB1204S-TL-E](#) [2SC2712S-GR,LF](#) [2SC5488A-TL-H](#)
[2SD2150T100R](#) [SP000011176](#) [2N2907A](#) [2N3904-NS](#) [2N5769](#) [2SC2412KT146S](#) [2SD1816S-TL-E](#) [CPH6501-TL-E](#) [MCH4021-TL-E](#)
[MJE340](#) [US6T6TR](#) [NJL0281DG](#) [732314D](#) [CPH3121-TL-E](#) [CPH6021-TL-H](#) [873787E](#) [IMZ2AT108](#) [UMX21NTR](#) [MCH6102-TL-E](#)
[NJL0302DG](#) [2N3583](#) [30A02MH-TL-E](#) [TN6717A](#) [NSV40301MZ4T1G](#) [NTE13](#) [NTE26](#) [NTE282](#) [NTE323](#) [NTE350](#) [NTE81](#)