

## SOD-123 Plastic-Encapsulate Diodes

### **BZT52B2V4-BZT52B43** ZENER DIODE

#### FEATURE

- Planar Die Construction
- 350mW Power Dissipation on Ceramic PCB
- General Purpose, Medium Current
- Ideally Suited for Automated Assembly Processes
- Available in Lead Free Version

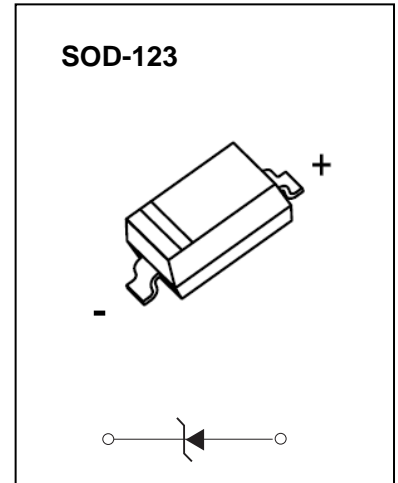

#### Maximum Ratings( $T_a=25^{\circ}\text{C}$ unless otherwise specified)

Characteristic	Symbol	Value	Unit
Forward Voltage (Note 2) @ $I_F = 10\text{mA}$	$V_F$	0.9	V
Power Dissipation(Note 1)	$P_d$	350	mW
Thermal Resistance from Junction to Ambient	$R_{\theta JA}$	357	$^{\circ}\text{C/W}$
Operation Junction and Storage Temperature Range	$T_J, T_{stg}$	-55 ~ +150	$^{\circ}\text{C}$

# ELECTRICAL CHARACTERISTICS

$T_a=25^{\circ}\text{C}$  unless otherwise specified

Type Number	Type Code	Zener Voltage Range (Note 2)				Maximum Zener Impedance (Note 3)			Maximum Reverse Current		Typical Temperature Coefficient @ $I_{ZTC}$		Test Current $I_{ZTC}$
		$V_Z@I_{ZT}$			$I_{ZT}$	$Z_{ZT}@I_{ZT}$	$Z_{ZK}@I_{ZK}$	$I_{ZK}$	$I_R$	$V_R$	mV/ $^{\circ}\text{C}$		
		Nom(V)	Min(V)	Max(V)	mA	$\Omega$		mA	$\mu\text{A}$	V	Min	Max	
BZT52B2V4	2WX	2.4	2.35	2.45	5	100	600	1.0	50	1.0	-3.5	0	5
BZT52B2V7	2W1	2.7	2.65	2.75	5	100	600	1.0	20	1.0	-3.5	0	5
BZT52B3V0	2W2	3.0	2.94	3.06	5	95	600	1.0	10	1.0	-3.5	0	5
BZT52B3V3	2W3	3.3	3.23	3.37	5	95	600	1.0	5	1.0	-3.5	0	5
BZT52B3V6	2W4	3.6	3.53	3.67	5	90	600	1.0	5	1.0	-3.5	0	5
BZT52B3V9	2W5	3.9	3.82	3.98	5	90	600	1.0	3	1.0	-3.5	0	5
BZT52B4V3	2W6	4.3	4.21	4.39	5	90	600	1.0	3	1.0	-3.5	0	5
BZT52B4V7	2W7	4.7	4.61	4.79	5	80	500	1.0	3	2.0	-3.5	0.2	5
BZT52B5V1	2W8	5.1	5.00	5.20	5	60	480	1.0	2	2.0	-2.7	1.2	5
BZT52B5V6	2W9	5.6	5.49	5.71	5	40	400	1.0	1	2.0	-2.0	2.5	5
BZT52B6V2	2WA	6.2	6.08	6.32	5	10	150	1.0	3	4.0	0.4	3.7	5
BZT52B6V8	2WB	6.8	6.66	6.94	5	15	80	1.0	2	4.0	1.2	4.5	5
BZT52B7V5	2WC	7.5	7.35	7.65	5	15	80	1.0	1	5.0	2.5	5.3	5
BZT52B8V2	2WD	8.2	8.04	8.36	5	15	80	1.0	0.7	5.0	3.2	6.2	5
BZT52B9V1	2WE	9.1	8.92	9.28	5	15	100	1.0	0.5	6.0	3.8	7.0	5
BZT52B10	2WF	10	9.80	10.20	5	20	150	1.0	0.2	7.0	4.5	8.0	5
BZT52B11	2WG	11	10.78	11.22	5	20	150	1.0	0.1	8.0	5.4	9.0	5
BZT52B12	2WH	12	11.76	12.24	5	25	150	1.0	0.1	8.0	6.0	10.0	5
BZT52B13	2WI	13	12.74	13.26	5	30	170	1.0	0.1	8.0	7.0	11.0	5
BZT52B15	2WJ	15	14.70	15.30	5	30	200	1.0	0.1	10.5	9.2	13.0	5
BZT52B16	2WK	16	15.68	16.32	5	40	200	1.0	0.1	11.2	10.4	14.0	5
BZT52B18	2WL	18	17.64	18.36	5	45	225	1.0	0.1	12.6	12.4	16.0	5
BZT52B20	2WM	20	19.60	20.40	5	55	225	1.0	0.1	14.0	14.4	18.0	5
BZT52B22	2WN	22	21.56	22.44	5	55	250	1.0	0.1	15.4	16.4	20.0	5
BZT52B24	2WO	24	23.52	24.48	5	70	250	1.0	0.1	16.8	18.4	22.0	5
BZT52B27	2WP	27	26.46	27.54	2	80	300	0.5	0.1	18.9	21.4	25.3	2
BZT52B30	2WQ	30	29.40	30.60	2	80	300	0.5	0.1	21.0	24.4	29.4	2
BZT52B33	2WR	33	32.34	33.66	2	80	325	0.5	0.1	23.1	27.4	33.4	2
BZT52B36	2WS	36	35.28	36.72	2	90	350	0.5	0.1	25.2	30.4	37.4	2
BZT52B39	2WT	39	38.22	39.78	2	130	350	0.5	0.1	27.3	33.4	41.2	2
BZT52B43	2WU	43	41.16	42.84	2	130	350	0.5	0.1	29.4	36.4	45.2	2

- Notes: 1. Device mounted on ceramic PCB:7.6mm x 9.4mm x 0.87mm with pad areas 25mm<sup>2</sup>  
 2. Short duration test pulse used to minimize self-heating effect  
 3.  $f = 1\text{kHz}$

# Typical Characteristics

Notes: Our company currently provide 5.1 V - 20 V products only

**Zener Characteristics ( $V_z$  5.1V to 20 V)**

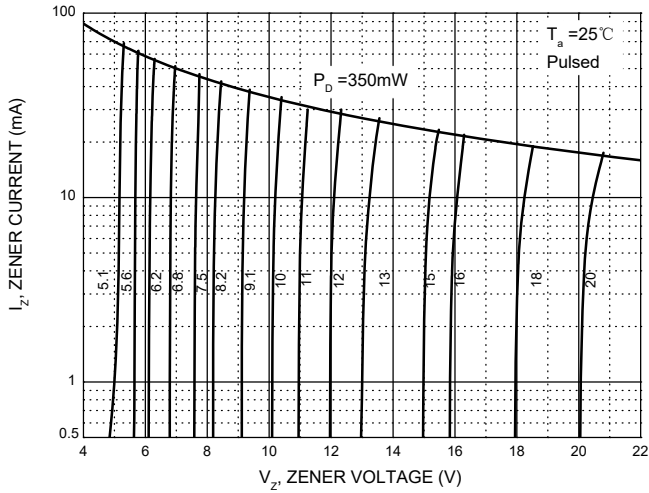

**Temperature Coefficients**

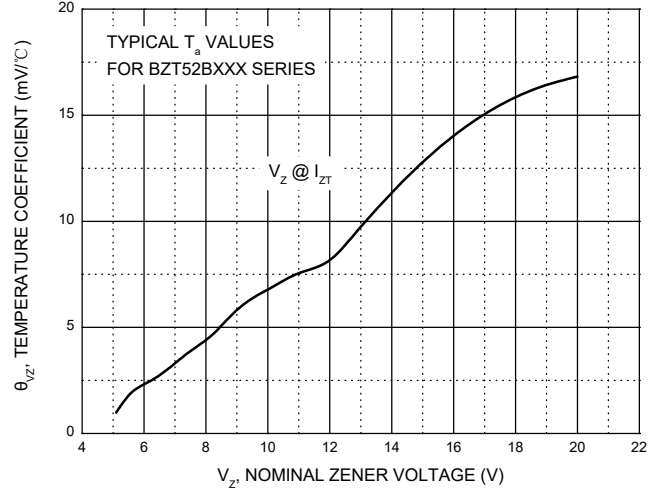

**Typical Leakage Current**

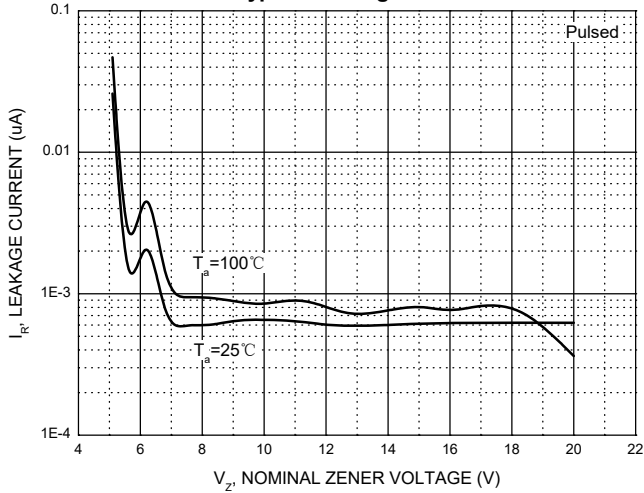

**Typical Capacitance**

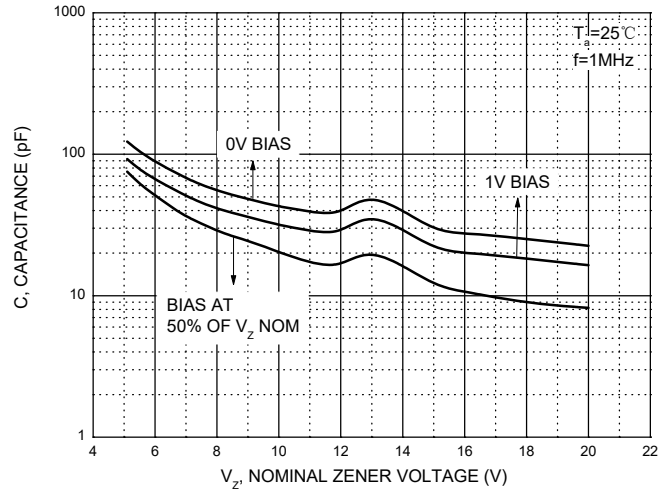

**Effect of Zener Voltage on Zener Impedance**

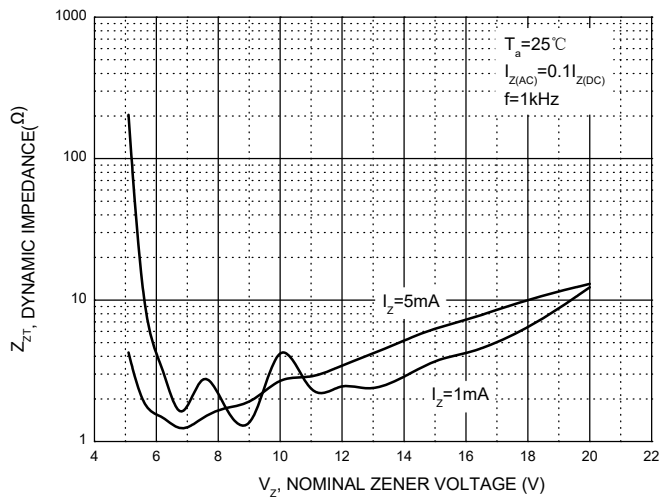

**Power Derating Curve**

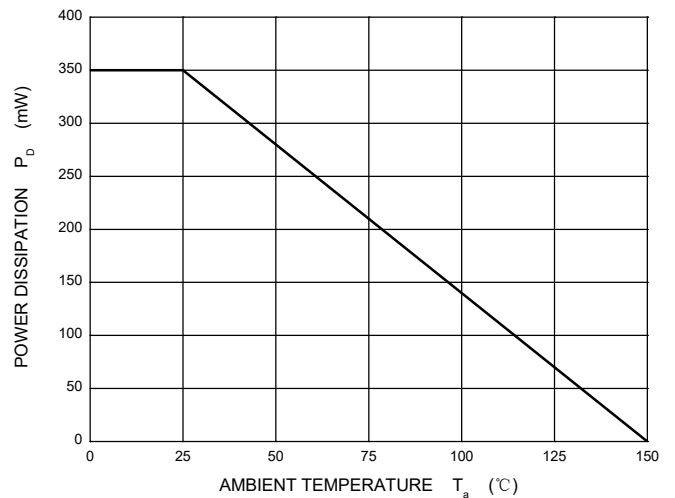

## SOD-123 Package Outline Dimensions

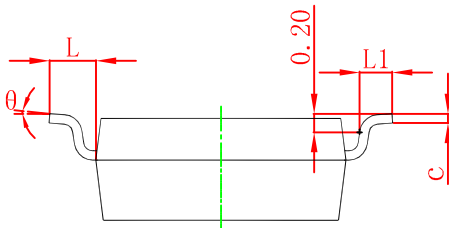
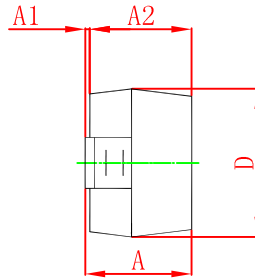
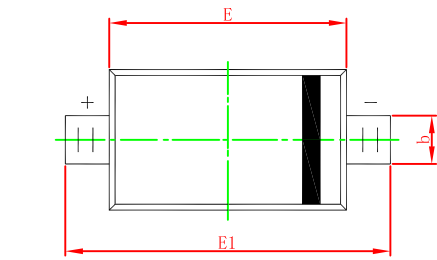

Symbol	Dimensions In Millimeters		Dimensions In Inches	
	Min	Max	Min	Max
A	1.050	1.250	0.041	0.049
A1	0.000	0.100	0.000	0.004
A2	1.050	1.150	0.041	0.045
b	0.450	0.650	0.018	0.026
c	0.080	0.150	0.003	0.006
D	1.500	1.700	0.059	0.067
E	2.600	2.800	0.102	0.110
E1	3.550	3.850	0.140	0.152
L	0.500 REF		0.020 REF	
L1	0.250	0.450	0.010	0.018
θ	0°	8°	0°	8°

## SOD-123 Suggested Pad Layout

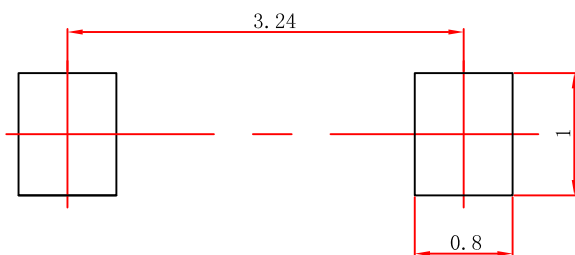

### Note:

1. Controlling dimension: in millimeters.
2. General tolerance:  $\pm 0.05\text{mm}$ .
3. The pad layout is for reference purposes only.

### NOTICE

JSCJ reserves the right to make modifications, enhancements, improvements, corrections or other changes without further notice to any product herein. JSCJ does not assume any liability arising out of the application or use of any product described herein.

# SOD-123 Tape and Reel

## SOD-123 Embossed Carrier Tape

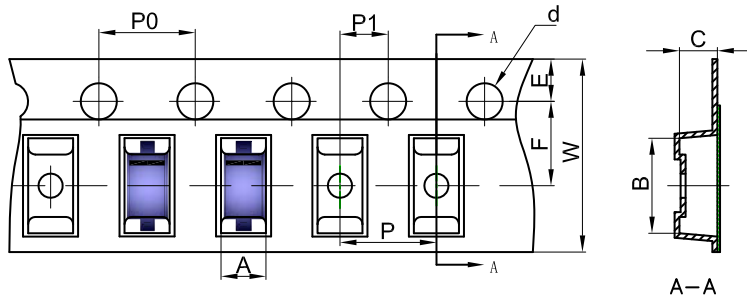

### Packaging Description:

SOD-123 parts are shipped in tape. The carrier tape is made from a dissipative (carbon filled) polycarbonate resin. The cover tape is a multilayer film (Heat Activated Adhesive in nature) primarily composed of polyester film, adhesive layer, sealant, and anti-static sprayed agent. These reeled parts in standard option are shipped with 3,000 units per 7" or 17.8cm diameter reel. The reels are clear in color and is made of polystyrene plastic (anti-static coated).

Dimensions are in millimeter

Pkg type	A	B	C	d	E	F	P0	P	P1	W
SOD-123	1.85	3.95	1.57	Ø1.55	1.75	3.50	4.00	4.00	2.00	8.00

## SOD-123 Tape Leader and Trailer

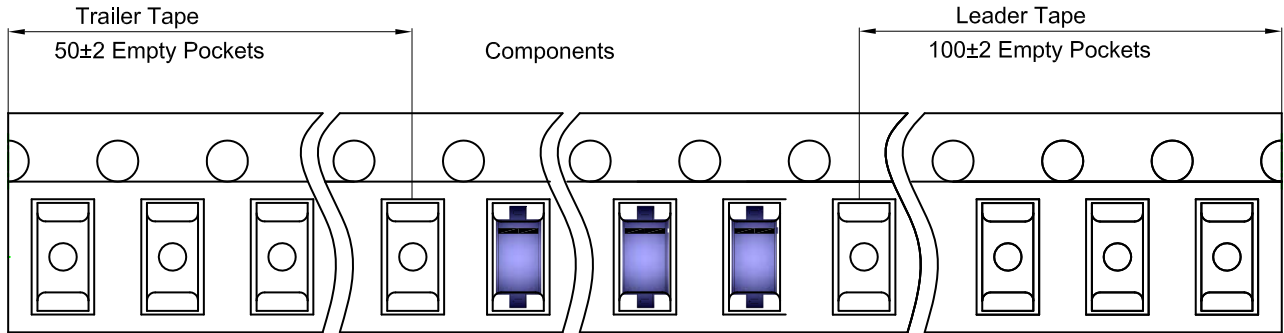

## SOD-123 Reel

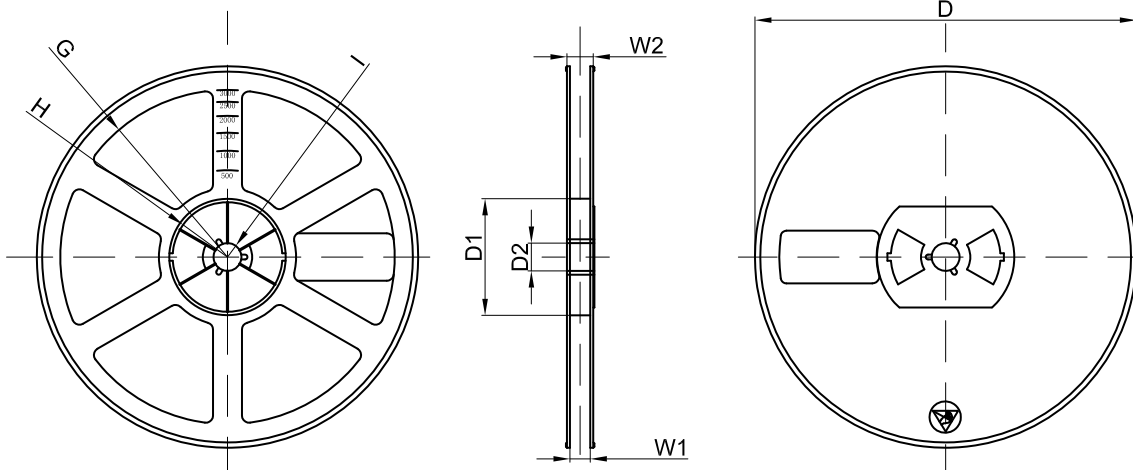

Dimensions are in millimeter

Reel Option	D	D1	D2	G	H	I	W1	W2
7" Dia	Ø178.00	54.40	13.00	R78.00	R25.60	R6.50	9.50	12.30

REEL	Reel Size	Box	Box Size(mm)	Carton	Carton Size(mm)	G.W.(kg)
3000 pcs	7 inch	45,000 pcs	203×203×195	180,000 pcs	438×438×220	

## X-ON Electronics

Largest Supplier of Electrical and Electronic Components

*Click to view similar products for [Zener Diodes](#) category:*

*Click to view products by [Changjing Electronics Technology](#) manufacturer:*

Other Similar products are found below :

[RKZ13B2KG#P1](#) [DL5234B](#) [EDZTE6113B](#) [1N4682](#) [1N4691](#) [1N4693](#) [1N4732A](#) [1N4736A](#) [1N4750A](#) [1N4759ARL](#) [1N5241B](#) [1N5365B](#)  
[1N5369B](#) [1N747A](#) [1N959B](#) [1N964B](#) [1N966B](#) [1N968B](#) [1N972B](#) [NTE5121A](#) [NTE5147A](#) [NTE5152A](#) [NTE5155A](#) [NTE5164A](#)  
[JANS1N4974US](#) [1N4692](#) [1N4700](#) [1N4702](#) [1N4704](#) [1N4711](#) [1N4714](#) [1N4737A](#) [1N4745ARL](#) [1N4752A](#) [1N4752ARL](#) [1N4760ARL](#)  
[1N5221B](#) [1N5236B](#) [1N5241BTR](#) [1N5242BTR](#) [1N5350B](#) [1N5352B](#) [1N961BRR1](#) [1N964BRL](#) [RKZ5.1BKU#P6](#) [3SMAJ5946B-TP](#)  
[3SMAJ5950B-TP](#) [3SMBJ5925B-TP](#) [441774C](#) [BZX84C3V9](#)