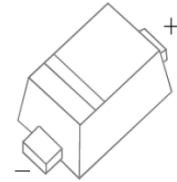

**SOD-523 Plastic-Encapsulate Diodes****BZX584B2V4-BZX584B39** ZENER DIODE

SOD-523

**FEATURES**

- Planar Die Construction
- 150mW Power Dissipation
- Zener Voltages from 2.4 – 39V

**MAXIMUM RATINGS( $T_a=25^{\circ}\text{C}$  unless otherwise specified )**

Characteristic	Symbol	Value	Unit
Forward Voltage @ $I_F=10\text{mA}$	$V_F$	0.9	V
Power Dissipation (Note 1)	$P_D$	150	mW
Thermal Resistance from Junction to Ambient	$R_{\theta JA}$	833	$^{\circ}\text{C/W}$
Operation Junction and Storage Temperature Range	$T_J, T_{STG}$	-55~+150	$^{\circ}\text{C}$

# ELECTRICAL CHARACTERISTICS

T<sub>a</sub>=25°C unless otherwise specified

Type Number	Type Code	Zener Voltage Range (Note 2)				Maximum Zener Impedance (Note 3)			Maximum Reverse Current		Typical Temperature Coefficient @I <sub>ZT</sub> =5 mA mV/°C	
		V <sub>Z</sub> @I <sub>ZT</sub>			I <sub>ZT</sub>	Z <sub>ZT</sub> @I <sub>ZT</sub>	Z <sub>ZK</sub> @I <sub>ZK</sub>	I <sub>ZK</sub>	I <sub>R</sub>	V <sub>R</sub>	Min	Max
		Nom(V)	Min(V)	Max(V)	mA	Ω		mA	μA	V		
BZX584B2V4	2V1	2.4	2.35	2.45	5	100	600	1.0	50	1.0	-3.5	0
BZX584B2V7	2V2	2.7	2.65	2.75	5	100	600	1.0	20	1.0	-3.5	0
BZX584B3V0	2V3	3	2.94	3.06	5	95	600	1.0	10	1.0	-3.5	0
BZX584B3V3	2V4	3.3	3.23	3.37	5	95	600	1.0	5	1.0	-3.5	0
BZX584B3V6	2V5	3.6	3.53	3.67	5	90	600	1.0	5	1.0	-3.5	0
BZX584B3V9	2V6	3.9	3.82	3.98	5	90	600	1.0	3	1.0	-3.5	0
BZX584B4V3	2V7	4.3	4.21	4.39	5	90	600	1.0	3	1.0	-3.5	0
BZX584B4V7	2Z1	4.7	4.61	4.79	5	80	500	1.0	3	2.0	-3.5	0.2
BZX584B5V1	2Z2	5.1	5.00	5.20	5	60	480	1.0	2	2.0	-2.7	1.2
BZX584B5V6	2Z3	5.6	5.49	5.71	5	40	400	1.0	1	2.0	-2.0	2.5
BZX584B6V2	2Z4	6.2	6.08	6.32	5	10	150	1.0	3	4.0	0.4	3.7
BZX584B6V8	2Z5	6.8	6.66	6.94	5	15	80	1.0	2	4.0	1.2	4.5
BZX584B7V5	2Z6	7.5	7.35	7.65	5	15	80	1.0	1	5.0	2.5	5.3
BZX584B8V2	2Z7	8.2	8.04	8.36	5	15	80	1.0	0.7	5.0	3.2	6.2
BZX584B9V1	2Z8	9.1	8.92	9.28	5	15	100	1.0	0.5	6.0	3.8	7.0
BZX584B10	2Z9	10	9.80	10.20	5	20	150	1.0	0.2	7.0	4.5	8.0
BZX584B11	2Y1	11	10.78	11.22	5	20	150	1.0	0.1	8.0	5.4	9.0
BZX584B12	2Y2	12	11.76	12.24	5	25	150	1.0	0.1	8.0	6.0	10.0
BZX584B13	2Y3	13	12.74	13.26	5	30	170	1.0	0.1	8.0	7.0	11.0
BZX584B15	2Y4	15	14.70	15.30	5	30	200	1.0	0.1	10.5	9.2	13.0
BZX584B16	2Y5	16	15.68	16.32	5	40	200	1.0	0.1	11.2	10.4	14.0
BZX584B18	2Y6	18	17.64	18.36	5	45	225	1.0	0.1	12.6	12.4	16.0
BZX584B20	2Y7	20	19.60	20.40	5	55	225	1.0	0.1	14.0	14.4	18.0
BZX584B22	2Y8	22	21.56	22.44	5	55	250	1.0	0.1	15.4	16.4	20.0
BZX584B24	2Y9	24	23.52	24.48	5	70	250	1.0	0.1	16.8	18.4	22.0
BZX584B27	2X1	27	26.46	27.54	2	80	300	0.5	0.1	18.9	21.4	25.3
BZX584B30	2X2	30	29.40	30.60	2	80	300	0.5	0.1	21.0	24.4	29.4
BZX584B33	2X3	33	32.34	33.66	2	80	325	0.5	0.1	23.1	27.4	33.4
BZX584B36	2X4	36	35.28	36.72	2	90	350	0.5	0.1	25.2	30.4	37.4
BZX584B39	2X5	39	38.22	39.78	2	130	350	0.5	0.1	27.3	33.4	41.2

Notes:

1. Valid provided that device terminals are kept at ambient temperature.
2. Tested with pulses, period=5ms,pulse width =300μs.
3. f=1kHz.

# Typical Characteristics

Notes: Our company currently provide 5.1 V - 20 V products only

Zener Characteristics ( $V_z$  5.1V to 20 V)

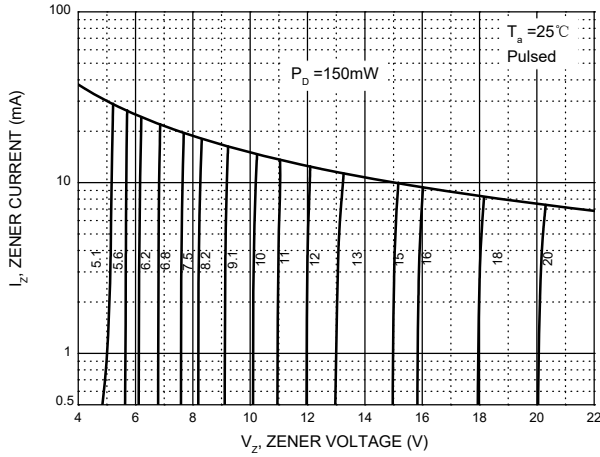

Temperature Coefficients

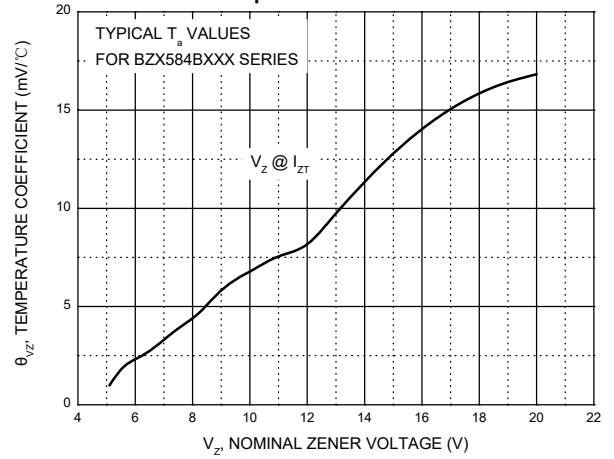

Typical Leakage Current

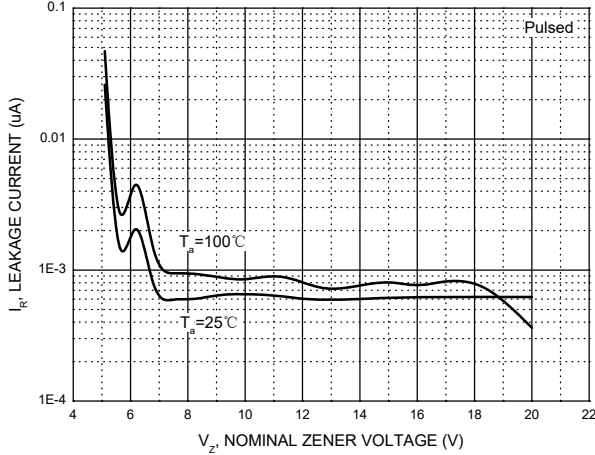

Typical Capacitance

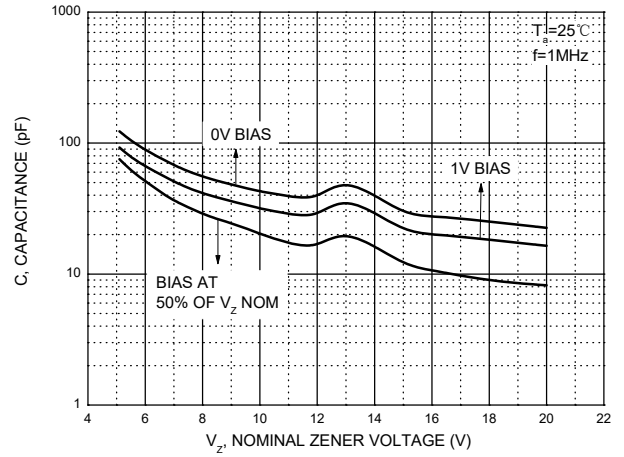

Effect of Zener Voltage on Zener Impedance

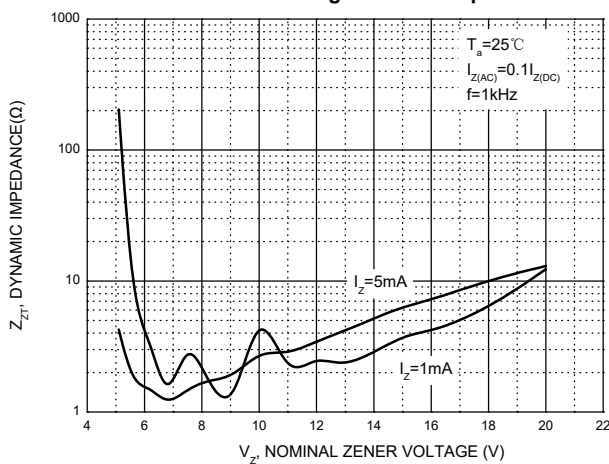

Power Derating Curve

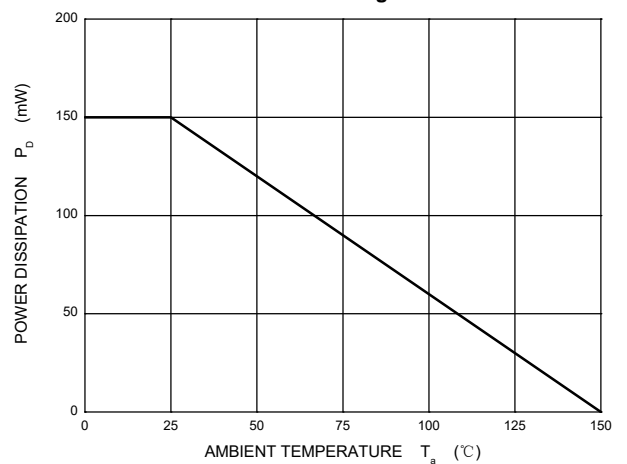

## SOD-523 Package Outline Dimensions

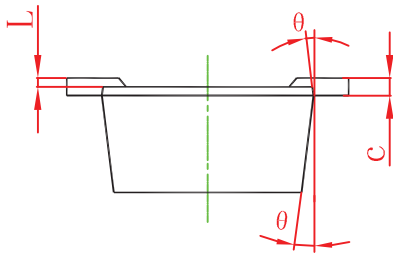
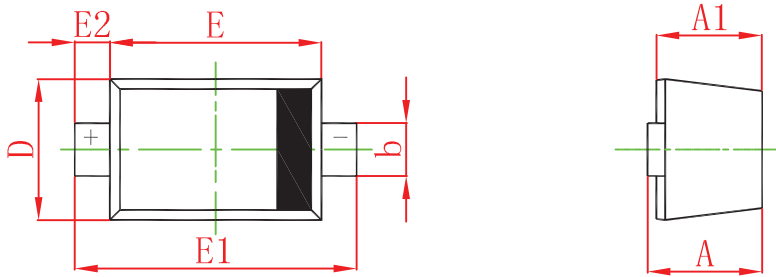

Symbol	Dimensions In Millimeters		Dimensions In Inches	
	Min	Max	Min	Max
A	0.510	0.770	0.020	0.031
A1	0.500	0.700	0.020	0.028
b	0.250	0.350	0.010	0.014
c	0.080	0.150	0.003	0.006
D	0.750	0.850	0.030	0.033
E	1.100	1.300	0.043	0.051
E1	1.500	1.700	0.059	0.067
E2	0.200 REF		0.008 REF	
L	0.010	0.070	0.001	0.003
θ	7° REF		7° REF	

## SOD-523 Suggested Pad Layout

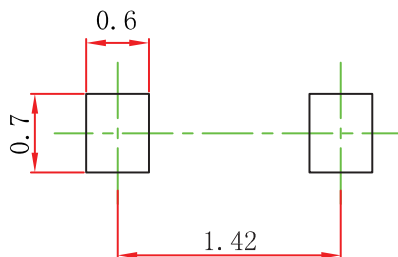

**Note:**

1. Controlling dimension: in millimeters.
2. General tolerance:  $\pm 0.05\text{mm}$ .
3. The pad layout is for reference purposes only.

**NOTICE**

JSCJ reserves the right to make modifications, enhancements, improvements, corrections or other changes without further notice to any product herein. JSCJ does not assume any liability arising out of the application or use of any product described herein.

# SOD-523 Tape and Reel

## SOD-523 Embossed Carrier Tape



### Packaging Description:

SOD-523 parts are shipped in tape. The carrier tape is made from a dissipative (carbon filled) polycarbonate resin. The cover tape is a multilayer film (Heat Activated Adhesive in nature) primarily composed of polyester film, adhesive layer, sealant, and anti-static sprayed agent. These reeled parts in standard option are shipped with 8,000 units per 7" or 17.8cm diameter reel. The reels are clear in color and is made of polystyrene plastic (anti-static coated).

NOTE: TO CAVE 'C' ON CARRIER TAPE PER 120MM

Dimensions are in millimeter											
Pkg type	A	B	C	d	E	F	P0	P	P1	W	
SOD-523	0.9	1.94	0.73	Ø1.50	1.75	3.50	4.00	2.00	2.00	8.00	

## SOD-523 Tape Leader and Trailer



## SOD-523 Reel

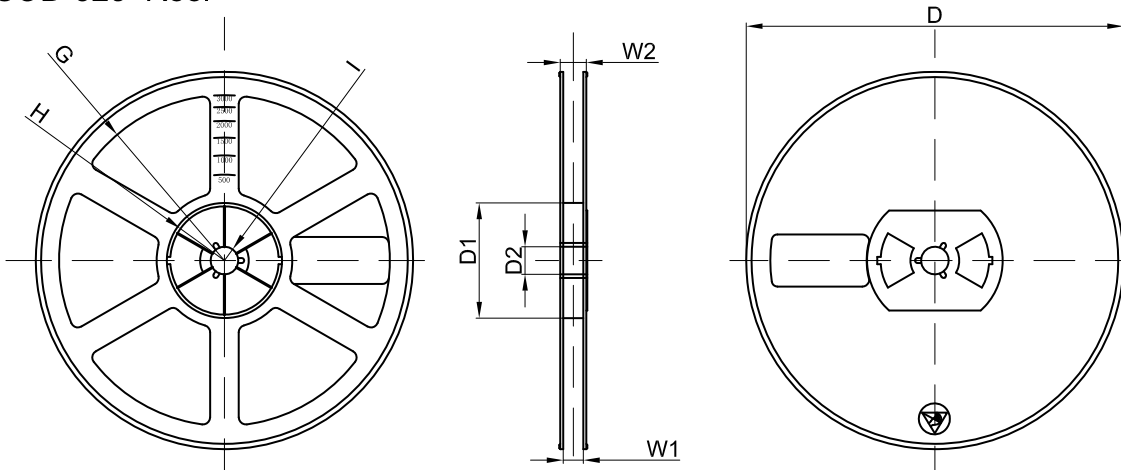

Dimensions are in millimeter								
Reel Option	D	D1	D2	G	H	I	W1	W2
7" Dia	Ø178.00	54.40	13.00	R78.00	R25.60	R6.50	9.50	12.30

REEL	Reel Size	Box	Box Size(mm)	Carton	Carton Size(mm)	G.W.(kg)
8000 pcs	7 inch	120,000 pcs	203×203×195	480,000 pcs	438×438×220	

## X-ON Electronics

Largest Supplier of Electrical and Electronic Components

*Click to view similar products for [Zener Diodes](#) category:*

*Click to view products by [Changjing Electronics Technology](#) manufacturer:*

Other Similar products are found below :

[RKZ13B2KG#P1](#) [RKZ5.6B2KJ#R1](#) [DL5234B](#) [EDZTE6113B](#) [1N4682](#) [1N4691](#) [1N4693](#) [1N4732A](#) [1N4736A](#) [1N4750A](#) [1N4759ARL](#)  
[1N5241B](#) [1N5365B](#) [1N5369B](#) [1N747A](#) [1N959B](#) [1N964B](#) [1N966B](#) [1N968B](#) [1N972B](#) [NTE5121A](#) [NTE5147A](#) [NTE5152A](#) [NTE5155A](#)  
[NTE5164A](#) [JANS1N4974US](#) [1N4692](#) [1N4700](#) [1N4702](#) [1N4704](#) [1N4711](#) [1N4714](#) [1N4737A](#) [1N4745ARL](#) [1N4752A](#) [1N4752ARL](#)  
[1N4760ARL](#) [1N5221B](#) [1N5231B-TR](#) [1N5236B](#) [1N5241BTR](#) [1N5242BTR](#) [1N5350B](#) [1N5352B](#) [1N961BRR1](#) [1N964BRL](#) [RKZ5.1BKU#P6](#)  
[3SMAJ5946B-TP](#) [3SMAJ5950B-TP](#) [3SMBJ5925B-TP](#)