

## CJ6101 Series

### ■ INTRODUCTION

The CJ6101 series are a group of positive voltage regulators manufactured by CMOS technologies with ultra low power consumption and low dropout voltage, which provide large output currents even when the difference of the input-output voltage is small. The CJ6101 series can deliver 300mA output current and allow an input voltage as high as 8V. The series are very suitable for the battery-powered equipments, such as RF applications and other systems requiring a quiet voltage source.

### ■ APPLICATIONS

- Portable consumer equipments
- Radio control systems
- Laptop, Palmtops and PDAs

### ■ FEATURES

- Low Quiescent Current: 0.7 $\mu$ A
- Operating Voltage Range: 1.8V~8V
- Output Current: 300mA
- Low Dropout Voltage:  
110mV@100mA( $V_{OUT}=3.3V$ )
- Output Voltage: 1.2~ 5.0V
- High Accuracy:  $\pm 2\%/ \pm 1\%$  (Typ.)
- High Power Supply Rejection Ratio:  
50dB@1kHz
- Low Output Noise:  
27x $V_{OUT}$   $\mu$ V<sub>RMS</sub> (10Hz~100kHz)
- Excellent Line and Load Transient Response
- Built-in Current Limiter, Short-Circuit Protection

- Wireless Communication Equipments
- Portable Audio Video Equipments
- Ultra Low Power Microcontroller

### ■ BLOCK DIAGRAM

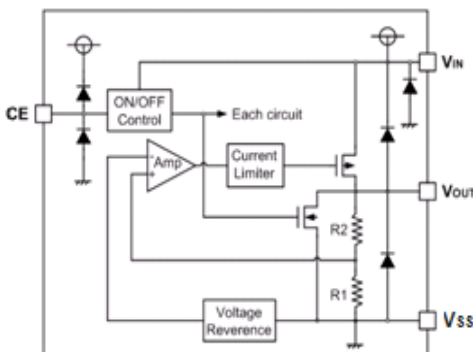

### ■ ORDER INFORMATION

#### CJ6101①②③④

DESIGNATOR	SYMBOL	DESCRIPTION
①	A	Standard
	B	High Active, pull-down resistor built in, with $C_{OUT}$ discharge resistor
	C	High Active, No pull-down resistor, No $C_{OUT}$ discharge resistor
②③	Integer	Output Voltage e.g. 1.8V=②:1, ③:8
④	M	Package:SOT-23-3L/5L
	P	Package:SOT-89-3L
	F	Package:WFBFP-04C/DFNWB1x1-4

## Pin Configuration

SOT-23-3L

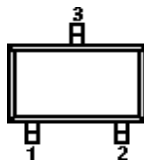

SOT-23-5L

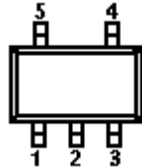

DFNWB1×1-4

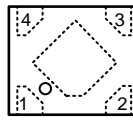

WBFBP-04C

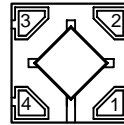

SOT-89-3L

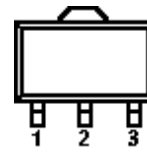

PIN NUMBER		PIN NAME	FUNCTION
SOT-23-3L	SOT-89-3L		
<b>M</b>	<b>P</b>		
1	1	$V_{SS}$	Ground
2	3	$V_{OUT}$	Output
3	2	$V_{IN}$	Power input

### SOT-23-5L

PIN NUMBER	SYMBOL	FUNCTION
1	$V_{IN}$	Power Input Pin
2	$V_{SS}$	Ground
3	CE	Chip Enable Pin
4	NC	No Connection
5	$V_{OUT}$	Output Pin

### DFNWB1×1-4/WBFBP-04C

PIN NUMBER	SYMBOL	FUNCTION
<b>F</b>		
1	$V_{OUT}$	Output Pin
2	$V_{SS}$	Ground
3	CE	Chip Enable Pin
4	$V_{IN}$	Power Input Pin

### ■ ABSOLUTE MAXIMUM RATINGS<sup>(1)</sup> (Unless otherwise specified, $T_A=25^\circ\text{C}$ )

PARAMETER	SYMBOL	RATINGS	UNITS
Input Voltage <sup>(2)</sup>	$V_{IN}$	-0.3~9	V
Output Voltage <sup>(2)</sup>	$V_{OUT}$	-0.3~ $V_{IN}+0.3$	V
Output Current	$I_{OUT}$	600	mA
Power Dissipation	SOT-23-3L/SOT-23-5L	0.3	W
	DFNWB1×1-4/WBFBP-04C	0.2	W
	SOT-89-3L	0.6	W
Operating Ambient Temperature Range	$T_A$	-40~+85	$^\circ\text{C}$
Operating Junction Temperature Range	$T_j$	-40~+125	$^\circ\text{C}$
Storage Temperature	$T_{stg}$	-40~+125	$^\circ\text{C}$
Soldering Temperature	$T_{solder}$	260, 10s	

## Electrical Characteristics

### Note:

(1) Stresses beyond those listed under *absolute maximum ratings* may cause permanent damage to the device. These are stress ratings only, and functional operation of the device at these or any other conditions beyond those indicated under *recommended operating conditions* is not implied. Exposure to absolute-maximum-rated conditions for extended periods may affect device reliability.

(2) All voltages are with respect to network ground terminal.

### RECOMMENDED OPERATING CONDITIONS

PARAMETER	MIN.	NOM.	MAX.	UNITS
Supply voltage at $V_{IN}$	1.8		8	V
Operating junction temperature range, $T_j$	-40		125	°C
Operating free air temperature range, $T_A$	-40		85	°C

### ELECTRICAL CHARACTERISTICS

( $V_{IN}=V_{OUT}+1V$ ,  $C_{IN}=C_{OUT}=1\mu F$ ,  $T_A=25^\circ C$ , unless otherwise specified)

PARAMETER	SYMBOL	CONDITIONS	MIN.	TYP. <sup>(3)</sup>	MAX.	UNITS	
Input Voltage	$V_{IN}$		1.8	—	8	V	
Output Voltage Range	$V_{OUT}$		1.2	—	5	V	
DC Output Accuracy		$I_{OUT}=1mA$	-2	—	2	%	
			-1	—	1	%	
Dropout Voltage	$V_{dif}^{(4)}$	$I_{OUT}=100mA, V_{OUT}=3.3V$	—	110	—	mV	
Supply Current	$I_{SS}$	$I_{OUT}$	0.6	0.7	1.3	$\mu A$	
		$=0$					
Standby Current	$I_{STBY}$	$1.2V \leq V_{OUT} \leq 3.3V$		1.0	1.5	$\mu A$	
		$3.3V < V_{OUT} \leq 5.0V$					
		$CE = V_{SS}$			0.1	$\mu A$	
Line Regulation	$\frac{\Delta V_{OUT}}{V_{OUT} \times \Delta V_{IN}}$	$I_{OUT}=10mA$ $V_{OUT}+1V \leq V_{IN} \leq 8V$	—	0.05	0.3	%/V	
Load Regulation	$\frac{\Delta V_{OUT}}{V_{OUT}}$	$V_{IN} = V_{OUT} + 1V$ , $1mA \leq I_{OUT} \leq 100mA$	—	10	—	mV	
Temperature Coefficient	$\frac{\Delta V_{OUT}}{V_{OUT} \times \Delta T_A}$	$I_{OUT}=10mA$ , $-40^\circ C < T_A < 125^\circ C$		100		ppm	
Output Current Limit	$I_{LIM}$	$V_{OUT} = 0.5 \times V_{OUT(Normal)}$ , $V_{IN} = 5V$	550	700	850	mA	
Short Current	$I_{SHORT}$	$V_{OUT} = V_{SS}$	—	20	—	mA	
Power Supply Rejection Ratio	PSRR	$I_{OUT}=50mA$	100Hz		70		dB
			1kHz	—	50	—	
			10kHz	—	40	—	
			100kHz	—	35	—	
Output Noise Voltage	$V_{ON}$	BW=10Hz to 100kHz	—	$27 \times V_{OUT}$	—	$\mu V_{RMS}$	
CE "High" Voltage	$V_{CE} "H"$		1.5		$V_{IN}$	V	
CE "Low" Voltage	$V_{CE} "L"$				0.3	V	

---

## Typical Characteristics

---

### Note:

(3) Typical numbers are at 25°C and represent the most likely norm.

(4)  $V_{dif}$ : The Difference Of Output Voltage And Input Voltage When Input Voltage Is Decreased Gradually Till Output Voltage Equals To 98% Of  $V_{OUT}$  (E).

### ■ TYPICAL APPLICATION CIRCUIT

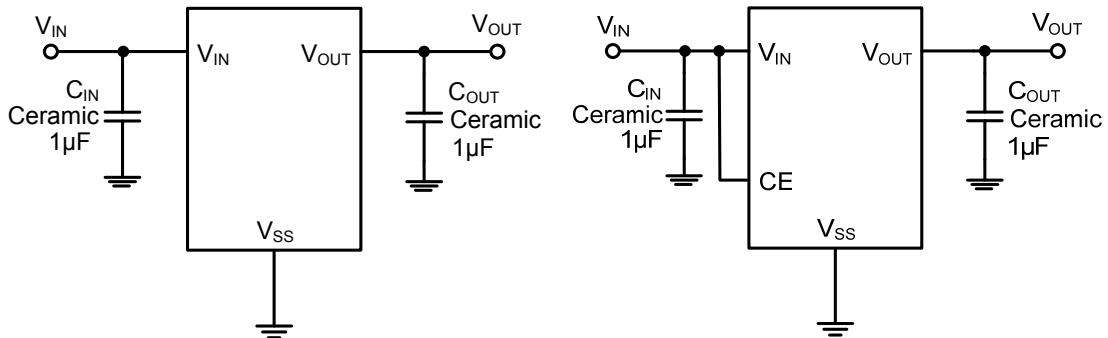

### ■ APPLICATION INFORMATION

#### Selection of Input/ Output Capacitors

In general, all the capacitors need to be low leakage. Any leakage the capacitors have will reduce efficiency, increase the quiescent current.

A recent trend in the design of portable devices has been to use ceramic capacitors to filter DC-DC converter inputs. Ceramic capacitors are often chosen because of their small size, low equivalent series resistance (ESR) and high RMS current capability. Also, recently, designers have been looking to ceramic capacitors due to shortages of tantalum capacitors.

Unfortunately, using ceramic capacitors for input filtering can cause problems. Applying a voltage step to a ceramic capacitor causes a large current surge that stores energy in the inductances of the power leads. A large voltage spike is created when the stored energy is transferred from these inductances into the ceramic capacitor. These voltage spikes can easily be twice the amplitude of the input voltage step.

Many types of capacitors can be used for input bypassing, however, caution must be exercised when using multilayer ceramic capacitors (MLCC). Because of the self-resonant and high Q characteristics of some types of ceramic capacitors, high voltage transients can be generated under some start-up conditions, such as connecting the LDO input to a live power source. Adding a 3Ω resistor in series with an X5R ceramic capacitor will minimize start-up voltage transients.

The LDO also requires an output capacitor for loop stability. Connect a 1µF tantalum capacitor from OUT to GND close to the pins. For improved transient response, this output capacitor may be ceramic.

# Typical Characteristics

( $V_{IN}=V_{OUT}+1V$ ,  $C_{IN}=C_{OUT}=1\mu F$ ,  $T_A=25^\circ C$ , unless otherwise specified)

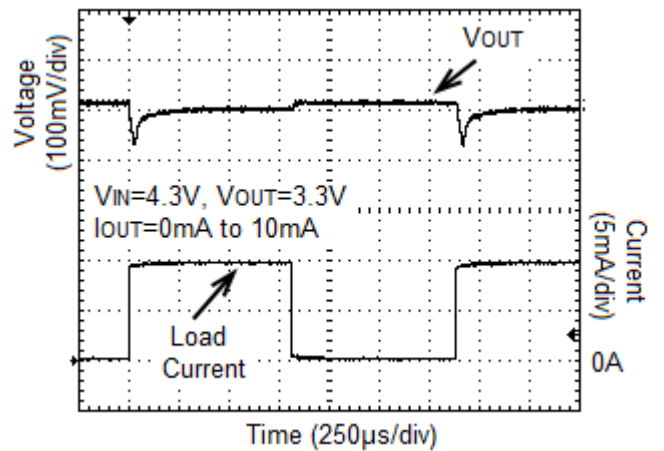
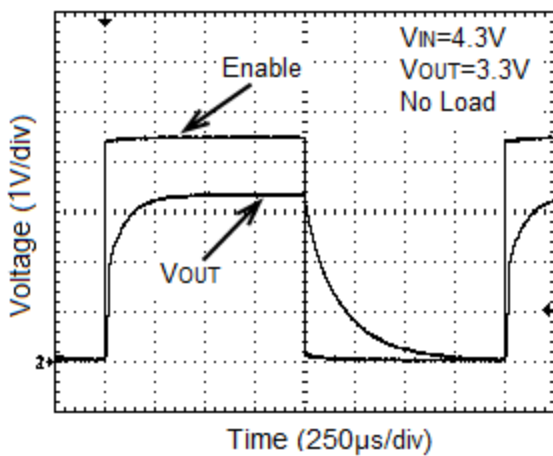
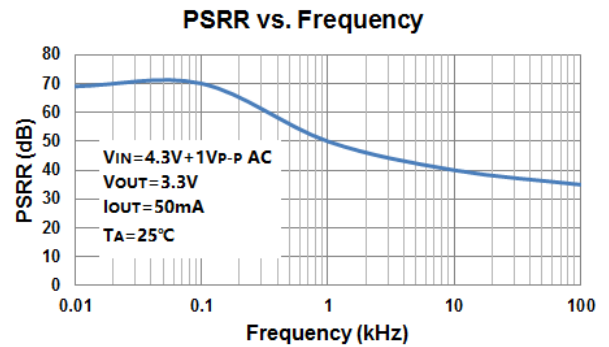
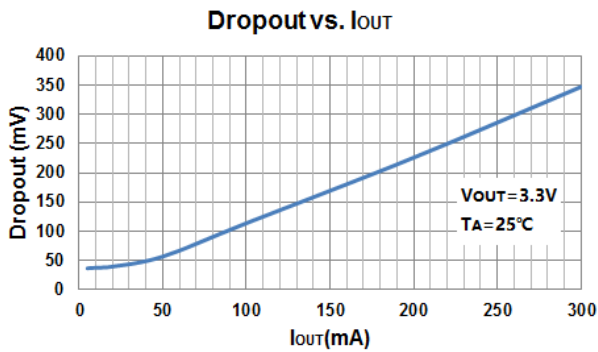
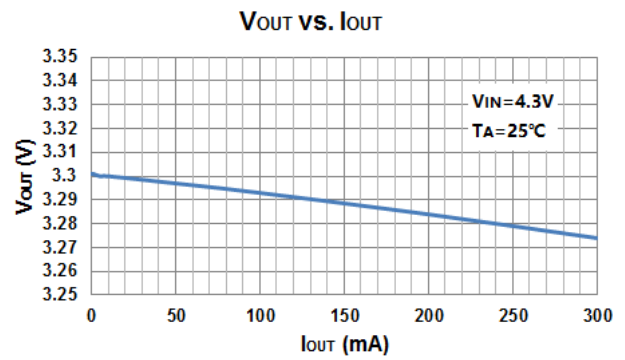
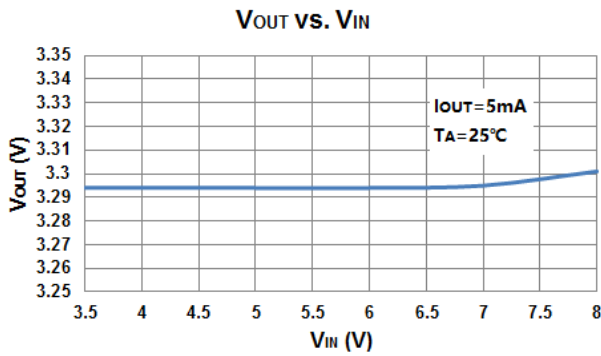
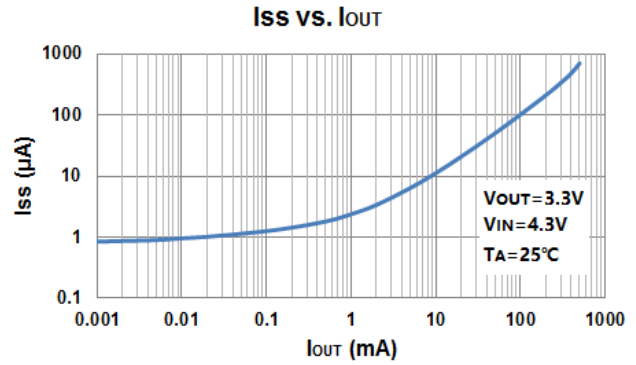
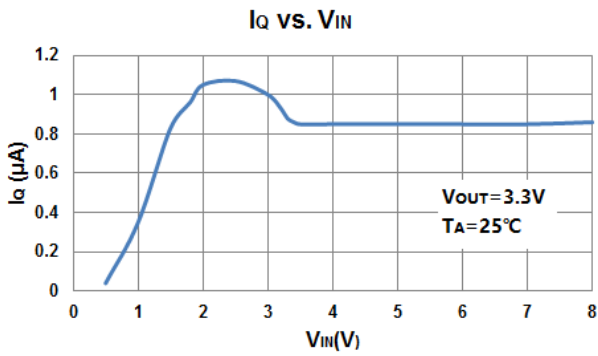

## SOT-23-3L Package Outline Dimensions

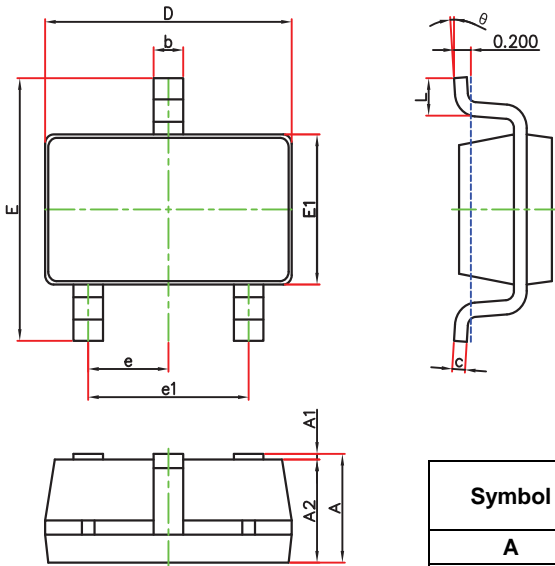

Symbol	Dimensions In Millimeters		Dimensions In Inches	
	Min.	Max.	Min.	Max.
A	1.050	1.250	0.041	0.049
A1	0.000	0.100	0.000	0.004
A2	1.050	1.150	0.041	0.045
b	0.300	0.500	0.012	0.020
c	0.100	0.200	0.004	0.008
D	2.820	3.020	0.111	0.119
E	2.650	2.950	0.104	0.116
E1	1.500	1.700	0.059	0.067
e	0.950(BSC)		0.037(BSC)	
e1	1.800	2.000	0.071	0.079
L	0.300	0.600	0.012	0.024
θ	0°	8°	0°	8°

## SOT-23-3L Suggested Pad Layout

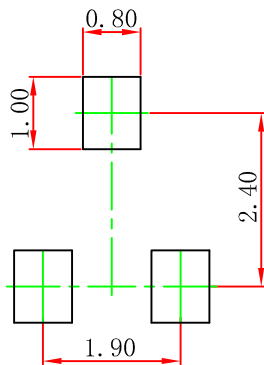

- Note:
1. Controlling dimension: in millimeters.
  2. General tolerance:  $\pm 0.05\text{mm}$ .
  3. The pad layout is for reference purposes only.

## SOT-23-5L Package Outline Dimensions

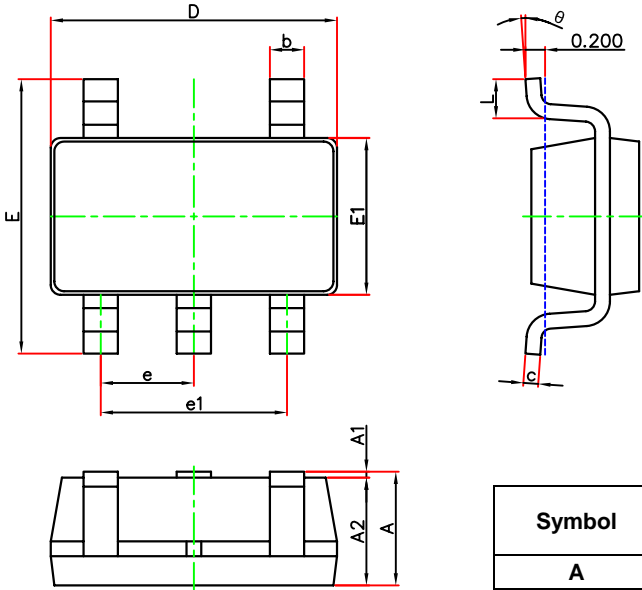

Symbol	Dimensions In Millimeters		Dimensions In Inches	
	Min.	Max.	Min.	Max.
A	1.050	1.250	0.041	0.049
A1	0.000	0.100	0.000	0.004
A2	1.050	1.150	0.041	0.045
b	0.300	0.500	0.012	0.020
c	0.100	0.200	0.004	0.008
D	2.820	3.020	0.111	0.119
E	2.650	2.950	0.104	0.116
E1	1.500	1.700	0.059	0.067
e	0.950(BSC)		0.037(BSC)	
e1	1.800	2.000	0.071	0.079
L	0.300	0.600	0.012	0.024
theta	0°	8°	0°	8°

## SOT-23-5L Suggested Pad Layout

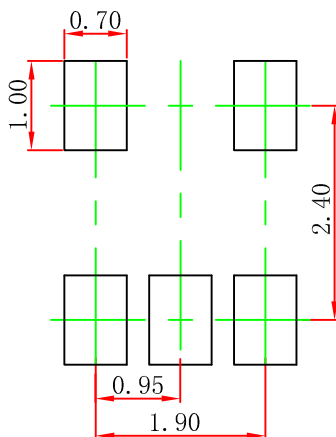

Note:

1. Controlling dimension: in millimeters.
2. General tolerance:  $\pm 0.05\text{mm}$ .
3. The pad layout is for reference purposes only.

## WBFBP-04C Package Outline Dimensions

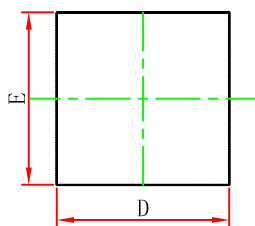

TOP VIEW

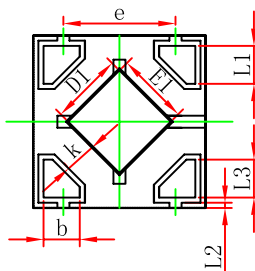

BOTTOM VIEW

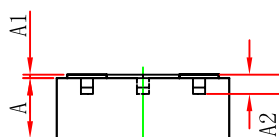

SIDE VIEW

Symbol	Dimensions In Millimeters		Dimensions In Inches	
	Min.	Max.	Min.	Max.
<b>A</b>	<b>0.335</b>	<b>0.405</b>	<b>0.013</b>	<b>0.016</b>
<b>D</b>	<b>0.950</b>	<b>1.050</b>	<b>0.037</b>	<b>0.041</b>
<b>E</b>	<b>0.950</b>	<b>1.050</b>	<b>0.037</b>	<b>0.041</b>
<b>D1</b>	<b>0.370</b>	<b>0.470</b>	<b>0.015</b>	<b>0.019</b>
<b>E1</b>	<b>0.370</b>	<b>0.470</b>	<b>0.015</b>	<b>0.019</b>
<b>k</b>	<b>0.17MIN.</b>		<b>0.007MIN.</b>	
<b>b</b>	<b>0.160</b>	<b>0.260</b>	<b>0.006</b>	<b>0.010</b>
<b>c</b>	<b>0.010</b>	<b>0.090</b>	<b>0.000</b>	<b>0.004</b>
<b>e</b>	<b>0.600</b>	<b>0.700</b>	<b>0.024</b>	<b>0.028</b>
<b>L1</b>	<b>0.185</b>	<b>0.255</b>	<b>0.007</b>	<b>0.010</b>
<b>L2</b>	<b>0.030 REF.</b>		<b>0.001 REF.</b>	
<b>L3</b>	<b>0.185</b>	<b>0.255</b>	<b>0.007</b>	<b>0.010</b>

## WBFBP-04C Suggested Pad Layout

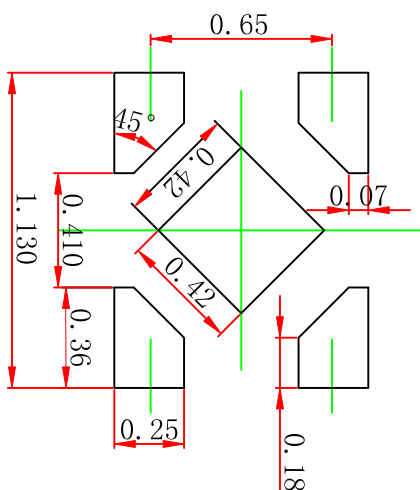

Note:

1. Controlling dimension: in millimeters.
2. General tolerance:  $\pm 0.05\text{mm}$ .
3. The pad layout is for reference purposes only.



## DFNWB1\*1-4L Package Outline Dimensions

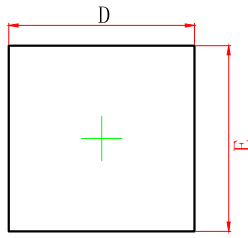

TOP VIEW

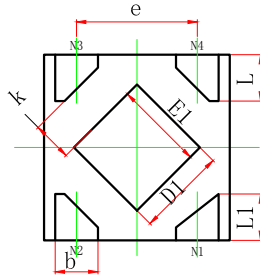

BOTTOM VIEW

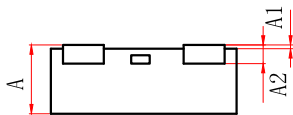

SIDE VIEW

Symbol	Dimensions In Millimeters		Dimensions In Inches	
	Min.	Max.	Min.	Max.
<b>A</b>	<b>0.320</b>	<b>0.400</b>	<b>0.013</b>	<b>0.016</b>
<b>A1</b>	<b>0.000</b>	<b>0.050</b>	<b>0.000</b>	<b>0.002</b>
<b>A2</b>	<b>0.100 REF.</b>		<b>0.004 REF.</b>	
<b>D</b>	<b>0.950</b>	<b>1.050</b>	<b>0.037</b>	<b>0.041</b>
<b>E</b>	<b>0.950</b>	<b>1.050</b>	<b>0.037</b>	<b>0.041</b>
<b>D1</b>	<b>0.430</b>	<b>0.530</b>	<b>0.017</b>	<b>0.021</b>
<b>E1</b>	<b>0.430</b>	<b>0.530</b>	<b>0.017</b>	<b>0.021</b>
<b>k</b>	<b>0.150MIN.</b>		<b>0.006MIN.</b>	
<b>b</b>	<b>0.180</b>	<b>0.280</b>	<b>0.007</b>	<b>0.011</b>
<b>e</b>	<b>0.650TYP.</b>		<b>0.026TYP.</b>	
<b>L</b>	<b>0.200</b>	<b>0.300</b>	<b>0.008</b>	<b>0.012</b>
<b>L1</b>	<b>0.200</b>	<b>0.300</b>	<b>0.008</b>	<b>0.012</b>

## DFNWB1\*1-4L Suggested Pad Layout

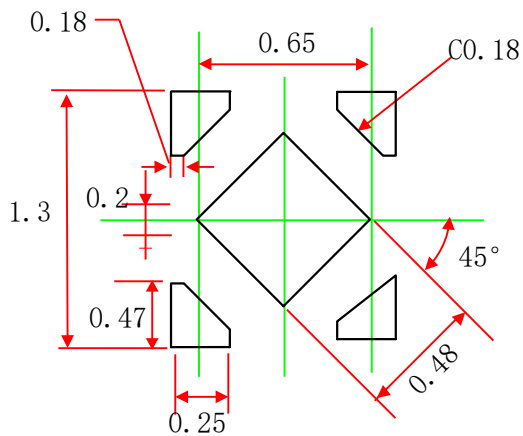

Note:

1. Controlling dimension: in millimeters.
2. General tolerance:  $\pm 0.05\text{mm}$ .
3. The pad layout is for reference purposes only.

## SOT-89-3L Package Outline Dimensions

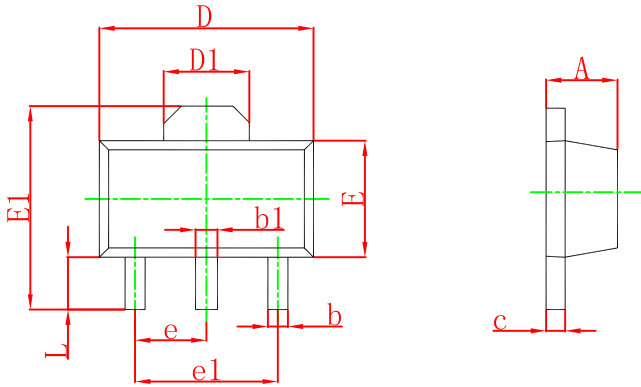

Symbol	Dimensions In Millimeters		Dimensions In Inches	
	Min.	Max.	Min.	Max.
A	1.400	1.600	0.055	0.063
b	0.320	0.520	0.013	0.197
b1	0.400	0.580	0.016	0.023
c	0.350	0.440	0.014	0.017
D	4.400	4.600	0.173	0.181
D1	1.550 REF		0.061 REF	
E	2.300	2.600	0.091	0.102
E1	3.940	4.250	0.155	0.167
e	1.500 TYP		0.060 TYP	
e1	3.000 TYP		0.118 TYP	
L	0.900	1.200	0.035	0.047

## SOT-89-3L Suggested Pad Layout

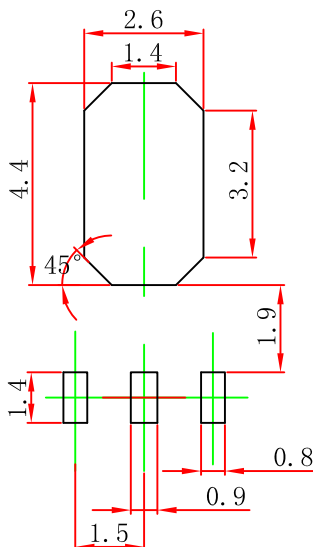

- Note:
1. Controlling dimension: in millimeters.
  2. General tolerance:  $\pm 0.05$  mm.
  3. The pad layout is for reference purposes only.

### NOTICE

JSCJ reserves the right to make modifications, enhancements, improvements, corrections or other changes without further notice to any product herein. JSCJ does not assume any liability arising out of the application or use of any product described herein.

## X-ON Electronics

Largest Supplier of Electrical and Electronic Components

*Click to view similar products for [Linear Voltage Regulators](#) category:*

*Click to view products by [Changjing Electronics Technology](#) manufacturer:*

Other Similar products are found below :

[LV56831P-E](#) [LV5684PVD-XH](#) [MCDTSA6-2R](#) [L7815ACV-DG](#) [PQ3DZ53U](#) [LV56801P-E](#) [TLE42794G](#) [L78L05CZ/1SX](#) [L78LR05DL-MA-E](#) [636416C](#) [714954EB](#) [BA033LBSG2-TR](#) [LV5680P-E](#) [L78M15CV-DG](#) [TLS202B1MBV33HTSA1](#) [L79M05T-E](#) [TLS202A1MBVHTSA1](#) [L78LR05D-MA-E](#) [NCV317MBTG](#) [NTE7227](#) [LV5680NPVC-XH](#) [LT1054CN8](#) [MP2018GZD-5-Z](#) [MP2018GZD-33-Z](#) [MIC5281-3.3YMM](#) [MC78L06BP-AP](#) [TA48LS05F\(TE85L,F\)](#) [TA78L12F\(TE12L,F\)](#) [TC47BR5003ECT](#) [TCR2LN12,LF\(S\)](#) [TCR2LN28,LF\(S\)](#) [TCR2LN30,LF\(S\)](#) [TCR3DF295,LM\(CT\)](#) [TCR3DF40,LM\(CT\)](#) [BA178M20CP-E2](#) [L78M12ABDT](#) [LM7812SX/NOPB](#) [LR645N3-G-P003](#) [LR645N3-G-P013](#) [ZXTR2005P5-13](#) [SCD7812BTG](#) [TCR3DF335,LM\(CT\)](#) [ZXTR2012K-13](#) [TLE42994E V33](#) [ZXTR2008K-13](#) [ZXTR2005K-13](#) [LA5693D-E](#) [L88R05DL-E](#) [ADP3300ARTZ-2.7RL7](#) [LM120K-15/883](#)