

## CJ6101 Series

### 1 Introduction

The CJ6101 series is a group of low dropout positive voltage regulators with ultra-low quiescent power consumption manufactured by CMOS technology. It can provide 300mA output current, and can provide large output current even when the input and output voltage difference is very small. Because of their ultra-low quiescent current, the CJ6101 series are very suitable for battery powered equipment, such as RF applications and other systems requiring quiet voltage sources, to improve the efficiency of these systems and prolong the battery life of the equipment.

### 2 Applications

- Portable consumer equipments
- Radio control systems
- Laptop, Palmtops and PDAs
- Wireless Communication Equipments
- Portable Audio Video Equipments
- Ultra Low Power Micro-controller

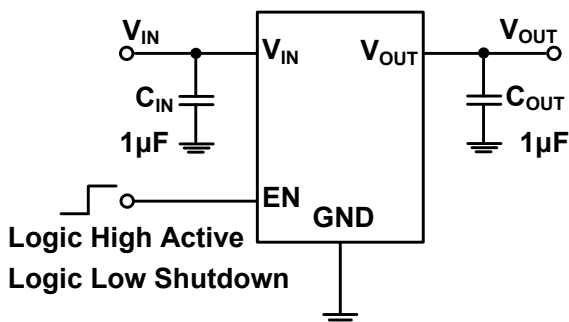

Figure 3-1. Typical Application Circuit

### 3 Features

- Low Quiescent Current: 0.8µA (Typ.)
- Operating Voltage Range: 1.8V ~ 6.0V
- Output Current: 300mA
- Dropout Voltage: 110mV@100mA ( $V_{OUT} = 3.3V$ )
- Output Voltage: 1.0V ~ 5.0V
- Accuracy:  $\pm 2\%$  (Typ.)
- Power Supply Rejection Ratio: 50dB@1kHz
- Low Output Noise:  $27 \times V_{OUT} \mu V_{RMS}$  (10Hz ~ 100kHz)
- Excellent Line and Load Transient Response
- Built-in Current Limiter, Short-Circuit Protection

### 4 Naming Scheme

Part Number: CJ6101①②③④		
DESIGNATOR	SYMBOL	DESCRIPTION
①	A	Standard
	B	With enable shutdown function, logic high active and logic low shutdown
②③	Integer	Output Voltage, e.g. 1.8V = ②:1, ③:8
④	M	Package: SOT-23-3L/5L
	P	Package: SOT-89-3L
	F	Package: DFNWB1×1-4L

**Note:** For more detailed packaging information, see the part *Orderable Information and Pin Configuration* and *Packaging Information*.

## 5 Orderable Information and Pin Configuration

### 5.1 Orderable Information

For the ordering information of this product, the following table lists all theoretically feasible product forms, and the actual products available are subject to the display on the official website.

MODEL	DEVICE	PACKAGE	OP TEMP	ECO PLAN	MSL	PACKING OPTION	SORT
CJ6101-1.8	CJ6101A18M	SOT-23-3L	-40 ~ 85°C	RoHS & Green	Level 3 168 HR	Tape and Reel 3000 Units / Reel	Active
CJ6101-2.8	CJ6101A28M	SOT-23-3L	-40 ~ 85°C	RoHS & Green	Level 3 168 HR	Tape and Reel 3000 Units / Reel	Active
CJ6101-3.0	CJ6101A30M	SOT-23-3L	-40 ~ 85°C	RoHS & Green	Level 3 168 HR	Tape and Reel 3000 Units / Reel	Active
CJ6101-3.3	CJ6101A33M	SOT-23-3L	-40 ~ 85°C	RoHS & Green	Level 3 168 HR	Tape and Reel 3000 Units / Reel	Active
CJ6101-3.6	CJ6101A36M	SOT-23-3L	-40 ~ 85°C	RoHS & Green	Level 3 168 HR	Tape and Reel 3000 Units / Reel	Active
CJ6101-1.8	CJ6101B18F	DFNWB1×1-4L	-40 ~ 85°C	RoHS & Green	Level 1 Infinite	Tape and Reel 10000 Units / Reel	Active
CJ6101-2.8	CJ6101B28F	DFNWB1×1-4L	-40 ~ 85°C	RoHS & Green	Level 1 Infinite	Tape and Reel 10000 Units / Reel	Active
CJ6101-3.0	CJ6101B30F	DFNWB1×1-4L	-40 ~ 85°C	RoHS & Green	Level 1 Infinite	Tape and Reel 10000 Units / Reel	Active
CJ6101-3.3	CJ6101B33F	DFNWB1×1-4L	-40 ~ 85°C	RoHS & Green	Level 1 Infinite	Tape and Reel 10000 Units / Reel	Active
CJ6101-1.8	CJ6101B18M	SOT-23-5L	-40 ~ 85°C	RoHS & Green	Level 3 168 HR	Tape and Reel 3000 Units / Reel	Active
CJ6101-2.8	CJ6101B28M	SOT-23-5L	-40 ~ 85°C	RoHS & Green	Level 3 168 HR	Tape and Reel 3000 Units / Reel	Active
CJ6101-3.0	CJ6101B30M	SOT-23-5L	-40 ~ 85°C	RoHS & Green	Level 3 168 HR	Tape and Reel 3000 Units / Reel	Active
CJ6101-3.3	CJ6101B33M	SOT-23-5L	-40 ~ 85°C	RoHS & Green	Level 3 168 HR	Tape and Reel 3000 Units / Reel	Active
CJ6101-3.6	CJ6101B36M	SOT-23-5L	-40 ~ 85°C	RoHS & Green	Level 3 168 HR	Tape and Reel 3000 Units / Reel	Active
Others	-	-	-	-	-	-	Customized

---

## 5 Orderable Information and Pin Configuration

---

### 5.1 Orderable Information(continued)

**Note:**

**ECO PLAN:** For the RoHS and Green certification standards of this product, please refer to the official report provided by JSCJ.

**MSL:** Moisture Sensitivity Level. Determined according to JEDEC industry standard classification.

**SORT:** Specifically defined as follows:

Active: Recommended for new products;

Customized: Products manufactured to meet the specific needs of customers;

Preview: The device has been released and has not been fully mass produced. The sample may or may not be available;

NoRD: It is not recommended to use the device for new design. The device is only produced for the needs of existing customers;

Obsolete: The device has been discontinued.

## 5 Orderable Information and Pin Configuration

### 5.2 Pin Configuration and Function

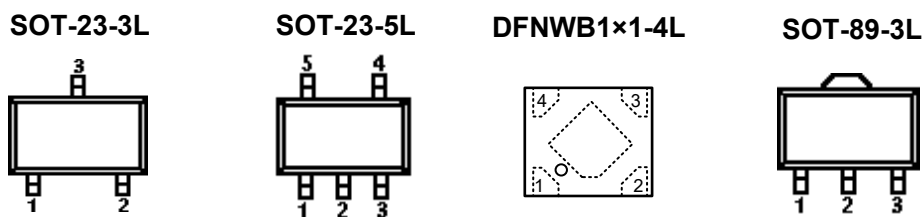

Figure 5-1. Package Top View

PIN NAME	CJ6101 Series		I / O	DESCRIPTION
	SOT-23-3L	SOT-89-3L		
	AxxM	AxxP		
IN	3	2	I	Input to the device.
GND	1	1	-	Regulator ground.
EN	-	-	-	Enable pin. Logic high to enable, logic low to disable. Don't float the pin.
NC	-	-	-	Not connected.
OUT	2	3	O	Output of the regulator.

PIN NAME	CJ6101 Series		I / O	DESCRIPTION
	SOT-23-5L	DFNWB1x1-4L		
	BxxM	BxxF		
IN	1	4	I	Input to the device.
GND	2	2	-	Regulator ground.
EN	3	3	-	Enable pin. Logic high to enable, logic low to disable. Don't float the pin.
NC	4	-	-	Not connected.
OUT	5	1	O	Output of the regulator.

## 6 Specifications

### 6.1 Absolute Maximum Ratings<sup>(1)</sup>

CHARACTERISTIC		SYMBOL	VALUE	UNITS	
Input voltage <sup>(2)</sup>		$V_{IN}$	-0.3 ~ 7	V	
Enable input voltage <sup>(2)</sup>		$V_{EN}$	-0.3 ~ ( $V_{IN} + 0.3$ )		
Output voltage <sup>(2)</sup>		$V_{OUT}$	-0.3 ~ ( $V_{IN} + 0.3$ )		
Maximum power dissipation	CJ6101	SOT-23-3L	$P_{D\ Max}$	Internally Limited <sup>(3)</sup>	W
		SOT-23-5L			
		SOT-89-3L			
		DFNWB×1-4L			
Maximum junction temperature		$T_{J\ Max}$	125	°C	
Storage temperature		$T_{stg}$	-40 ~ 125	°C	
Soldering temperature & time		$T_{solder}$	260°C, 10s	-	

(1) Stresses beyond those listed under *Absolute Maximum Ratings* may cause permanent damage to the device. These are stress ratings only, which do not imply functional operation of the device at these or any other conditions beyond those indicated under *Recommended Operating Conditions*. Exposure to absolute maximum rated conditions for extended periods may affect device reliability.

(2) All voltages are with respect to network ground terminal.

(3) Refer to *Thermal Information* for details.

### 6.2 Recommended Operating Conditions<sup>(4)</sup>

PARAMETER	SYMBOL	MIN.	NOM.	MAX.	UNIT
Input Voltage	$V_{IN}$	1.8	-	6.0	V
Operating Ambient Temperature	$T_A$	-40	-	- <sup>(5)</sup>	°C

(4) JSCJ strongly recommends that users should not exceed the rated value in the Recommended Operating Conditions for the application conditions of the equipment, so as to ensure the stability of normal operation and reliability of long-term operation of the equipment. Although operation beyond the recommended rated conditions does not mean that the product will fail. The consumers need to evaluate the risks that may be caused by the operation of the product beyond the recommended rated conditions.

(5) JSCJ recommends that the CJ6101 series should operate within the ambient temperature of - 40 to 85°C. Under the condition of good heat dissipation, the equipment can operate under the ambient temperature of more than 85°C. Consumers need to evaluate the possible risks of the equipment operating at ambient temperatures above 85°C and ensure that the operating junction temperature of the equipment does not exceed the rated value of the recommended working conditions.

## 6 Specifications

### 6.3 ESD Ratings

ESD RATINGS		SYMBOL	VALUE	UNIT
Electrostatic discharge <sup>(6)</sup>	Human body model	$V_{ESD-HBM}$	2000	V
	Machine model	$V_{ESD-MM}$	200	

(6) ESD testing is performed according to the respective JEDEC / JESD-22 standard. The human body model is a 100pF capacitor discharged through a 1.5k $\Omega$  resistor into each pin. The machine model is a 200pF capacitor discharged directly into each pin.

### 6.4 Thermal Information

THERMAL METRIC <sup>(7)</sup>	SYMBOL	CJ6101 Series				UNIT
		SOT-23-3L	SOT-23-5L	SOT-89-3L	DFNWB1 $\times$ 1-4L	
Junction-to-ambient thermal resistance	$R_{\Theta JA}$	250	250	200	220	$^{\circ}\text{C/W}$
Maximum power dissipation for reference	$P_{D \text{ Ref}}$	0.40	0.40	0.50	0.45	W

(7) Please see the part *Notes* for more information about thermal metrics.

## 6 Specifications

### 6.5 Electrical Characteristics

CJ6101 Series ( $V_{IN} = V_{OUT} + 1V$ ,  $C_{IN} = 1\mu F$ ,  $C_{OUT} = 1\mu F$ ,  $T_A = 25^\circ C$ , unless otherwise specified)

CHARACTERISTIC	SYMBOL	TEST CONDITIONS		MIN.	TYP. <sup>(8)</sup>	MAX.	UNIT
Input Voltage	$V_{IN}$	$T_J = 25^\circ C$		1.8	-	6.0	V
Output Voltage	$V_{OUT}$	$I_{OUT} = 1mA$		1.0	-	5.0	V
DC Output Accuracy <sup>(9)</sup>	-	$I_{OUT} = 1mA$		-2	-	2	%
Output Current	$I_{OUT}$	$V_{IN} = V_{OUT} + 1V$		300	500	-	mA
Output Current Limit	$I_{OUT\ Limit}$	$V_{OUT} = 0.5 \times V_{OUT(Normal)}$ , $V_{IN} = 5.0V$		350	550	750	mA
Quiescent Current	$I_Q$	$I_{OUT} = 0mA$		-	0.8	1.5	$\mu A$
Dropout Voltage	$V_{DO}^{(10)}$	$V_{OUT} < 1.5V$	$I_{OUT} = 100mA$	-	400	-	mV
		$V_{OUT} = 1.5\ to\ 2.0V$		-	200	-	
		$V_{OUT} > 2.0V$		-	110	-	
Line Regulation	$LNR^{(11)}$	$V_{IN} = V_{OUT} + 1V\ to\ 6V$ , $I_{OUT} = 10mA$		-	0.05	0.3	%/V
Load Regulation	$\Delta V_{LOAD}$	$V_{IN} = V_{OUT} + 1V$ , $I_{OUT} = 1\ to\ 100mA$		-	10	-	mV
Output Voltage Temperature Characteristics	$_{(12)}$	$I_{OUT} = 10mA$ , $T_A = -40\ to\ 85^\circ C$		-	100	-	ppm
Short Current	$I_{Short}$	$V_{OUT}$ short to GND		-	100	-	mA
Standby Current	$I_{STBY}$	$V_{EN} = GND$		-	-	0.1	$\mu A$
Power Supply Rejection Ratio	PSRR	$I_{OUT} = 50mA$ , $V_{IN} = (V_{OUT} + 1V)_{DC} + 0.5V_{PP\ AC}$	$f = 100Hz$	-	70	-	dB
			$f = 1kHz$	-	50	-	
			$f = 10kHz$	-	40	-	
			$f = 100kHz$	-	35	-	
EN High	$V_{EN\ H}$	$V_{IN} = V_{OUT} + 1V$		1.5	-	$V_{IN}$	V
EN Low	$V_{EN\ L}$	$V_{IN} = V_{OUT} + 1V$		-	-	0.3	V
Thermal Shutdown Temperature	$T_{SD}$	-		-	160	-	$^\circ C$
Thermal Shutdown Hysteresis	$\Delta T_{SD}$	-		-	20	-	$^\circ C$
Auto-discharge Resistance	$R_{Discharge}$	$V_{IN} = 5V$ , $V_{OUT} = 3.0V$ , $V_{EN} = GND$		-	100	-	$\Omega$

## 6 Specifications

### 6.5 Electrical Characteristics(continued)

Note:

(8) Typical numbers are at 25°C and represent the most likely norm.

(9) The effective output voltage range, which refers to the accuracy range that the output voltage may reach when the input voltage is equal to the output voltage plus 1V and the output current maintains a certain value.

(10) Test the difference of output voltage and input voltage when input voltage is decreased gradually till output voltage equals to 98% of  $V_{OUT(normal)}$ .

(11) The line regulation is calculated by the following formula:

$$LNR = \frac{\Delta V_{OUT}}{V_{OUT} \times \Delta V_{IN}}$$

where,  $\Delta V_{OUT}$  is the variation of the output voltage,  $\Delta V_{IN}$  is the variation of the input voltage.

(12) The output voltage temperature characteristics (TR) is calculated by the following formula:

$$TR = \frac{\Delta V_{OUT}}{V_{OUT} \times \Delta T}$$

where,  $\Delta V_{OUT}$  is the variation of the output voltage,  $\Delta T$  is the variation of the ambient temperature.

### 6.6 Typical Characteristics

**CJ6101 Series ( $V_{OUT} = 3.3V$ ,  $V_{IN} = V_{OUT} + 1V$ ,  $C_{IN} = 1\mu F$ ,  $C_{OUT} = 1\mu F$ ,  $T_A = 25^\circ C$ , unless otherwise specified)**

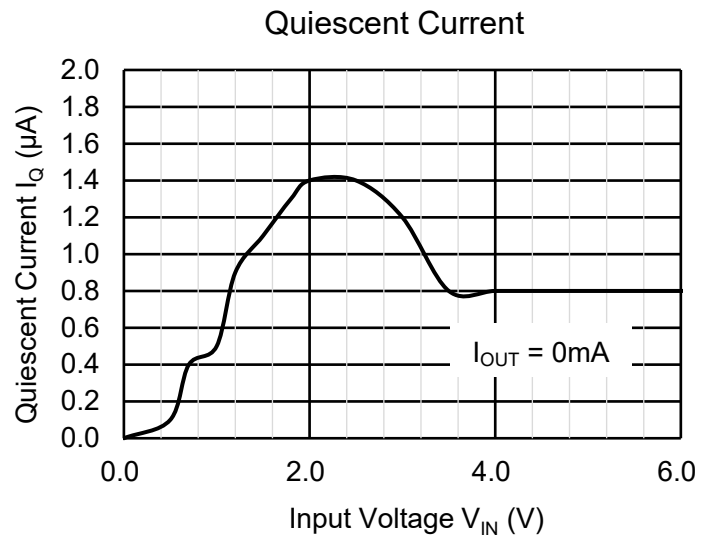
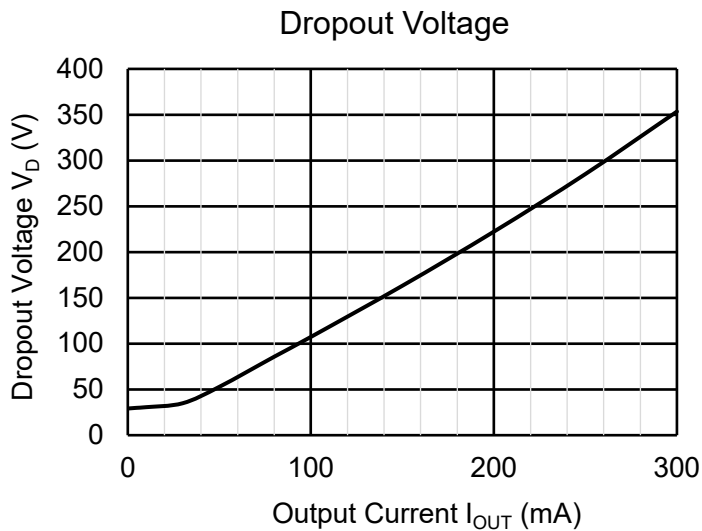



## 6 Specifications

### 6.6 Typical Characteristics(continued)

CJ6101 Series ( $V_{OUT} = 3.3V$ ,  $V_{IN} = V_{OUT} + 1V$ ,  $C_{IN} = 1\mu F$ ,  $C_{OUT} = 1\mu F$ ,  $T_A = 25^\circ C$ , unless otherwise specified)

Line Regulation

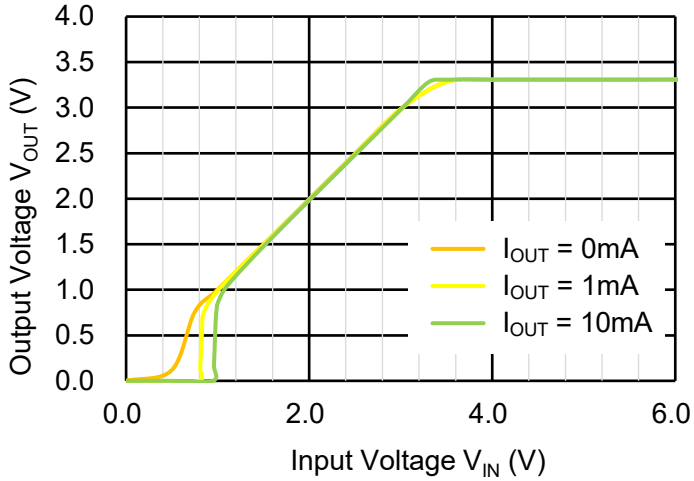

Line Regulation

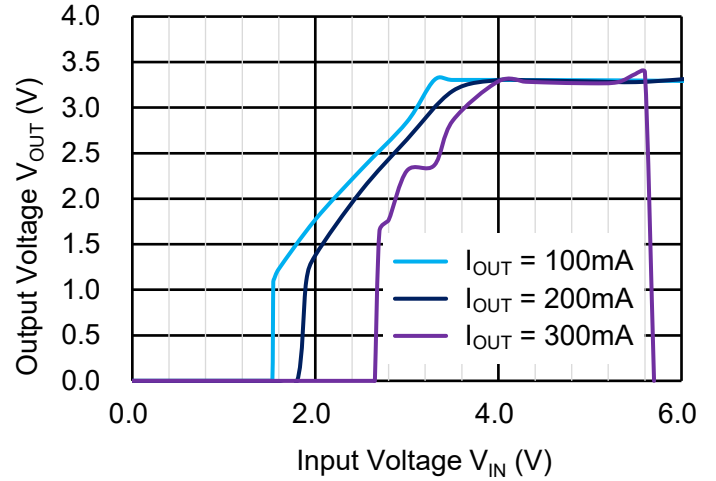

Load Regulation

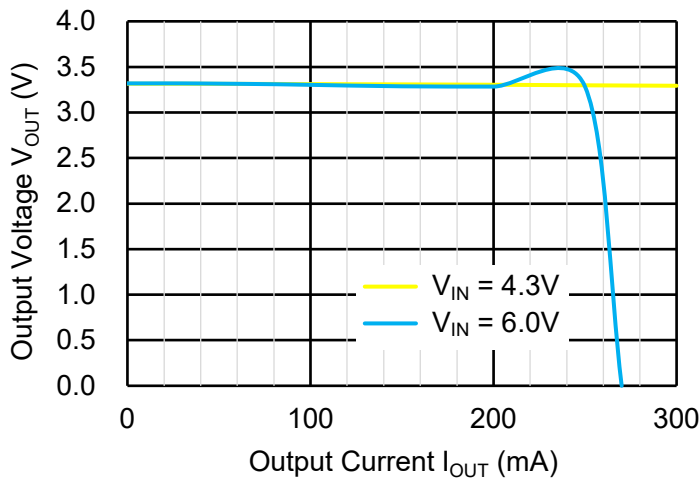

Power Supply Rejection Ratio

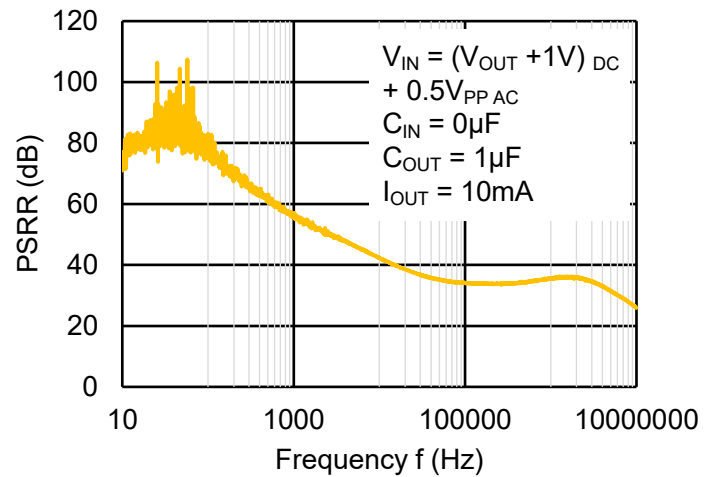

Power Supply Rejection Ratio

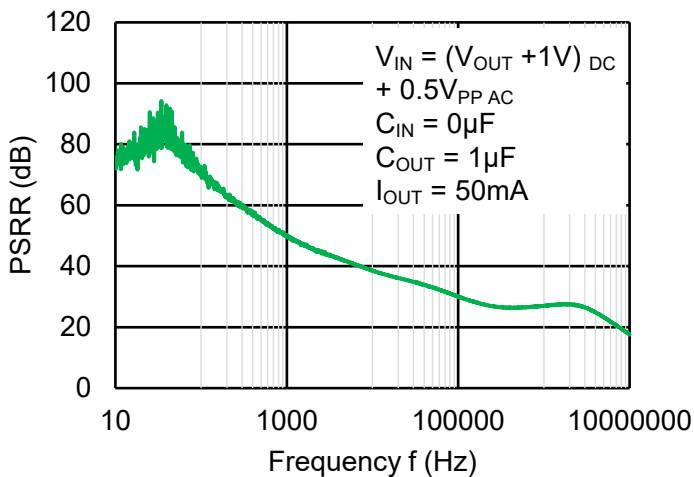

Power Supply Rejection Ratio

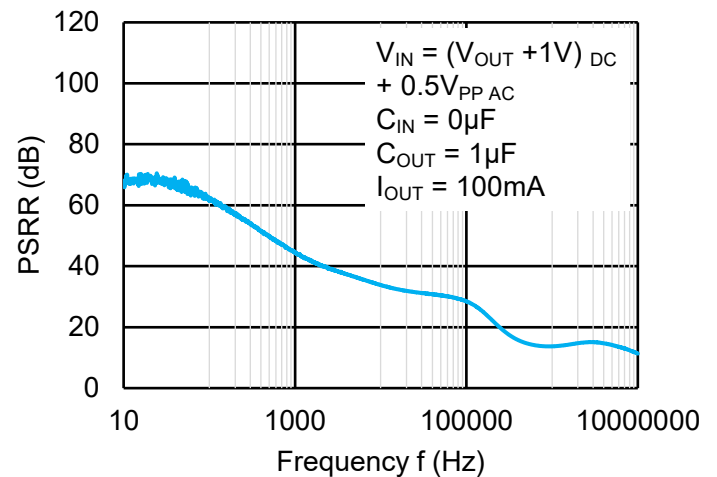

## 6 Specifications

### 6.6 Typical Characteristics(continued)

CJ6101 Series ( $V_{OUT} = 3.3V$ ,  $V_{IN} = V_{OUT} + 1V$ ,  $C_{IN} = 1\mu F$ ,  $C_{OUT} = 1\mu F$ ,  $T_A = 25^\circ C$ , unless otherwise specified)

#### Load Transient

$V_{IN} = 4.3V$ ,  $V_{EN} = V_{IN}$ ,  $V_{OUT} = 3.3V$ , CH2:  $V_{OUT}$ , CH4:  $I_{OUT}$

$I_{OUT} = 0$  to  $100mA$

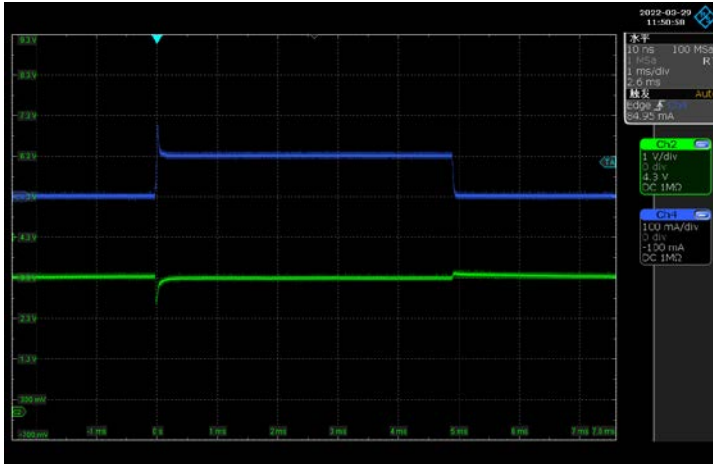

$I_{OUT} = 0$  to  $300mA$

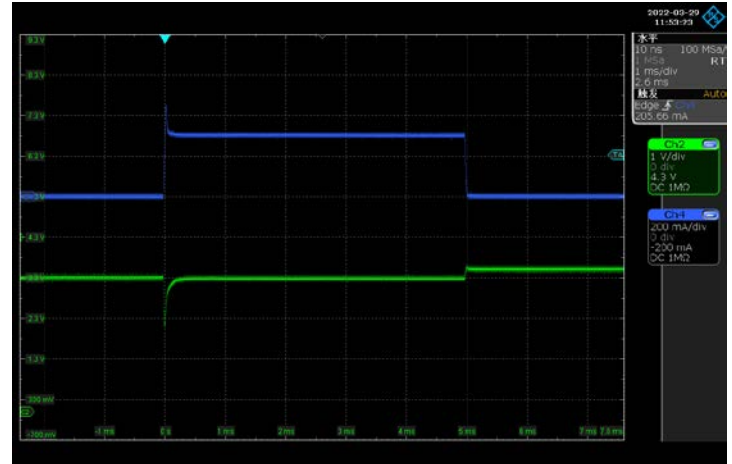

$I_{OUT} = 10$  to  $100mA$

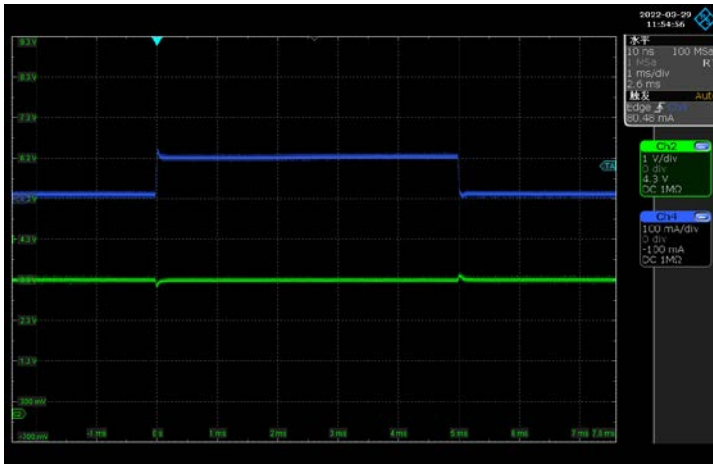

$I_{OUT} = 10$  to  $300mA$

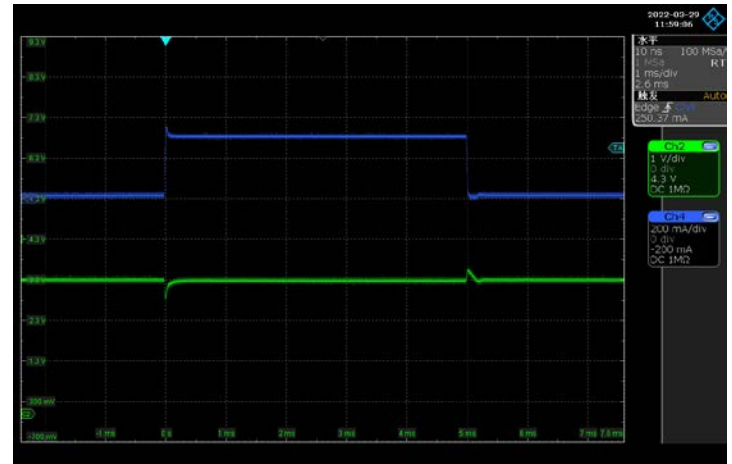

$I_{OUT} = 50$  to  $100mA$

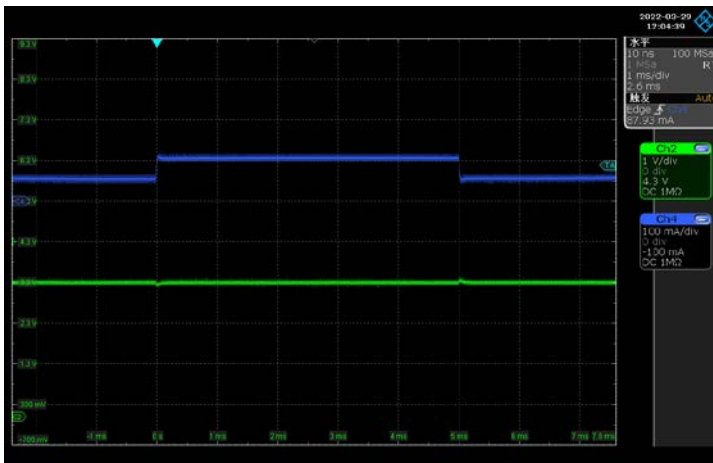

$I_{OUT} = 50$  to  $300mA$

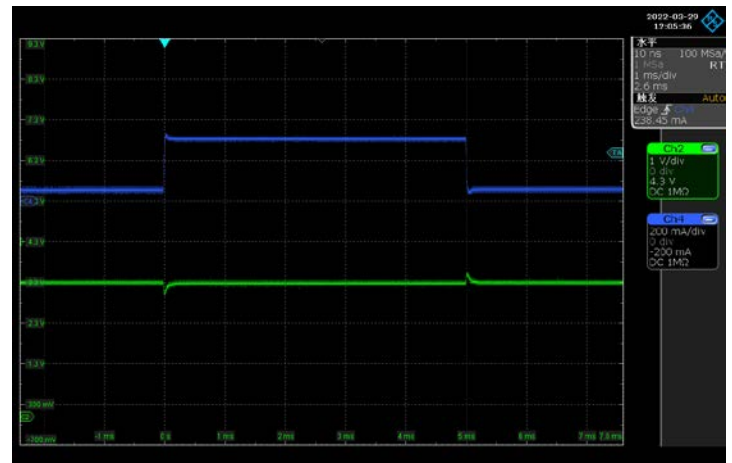

## 6 Specifications

### 6.6 Typical Characteristics(continued)

CJ6101 Series ( $V_{OUT} = 3.3V$ ,  $V_{IN} = V_{OUT} + 1V$ ,  $C_{IN} = 1\mu F$ ,  $C_{OUT} = 1\mu F$ ,  $T_A = 25^\circ C$ , unless otherwise specified)

#### Load Transient

$V_{IN} = 4.3V$ ,  $V_{EN} = V_{IN}$ ,  $V_{OUT} = 3.3V$ , CH2:  $V_{OUT}$ , CH4:  $I_{OUT}$   
 $I_{OUT} = 100$  to  $300mA$

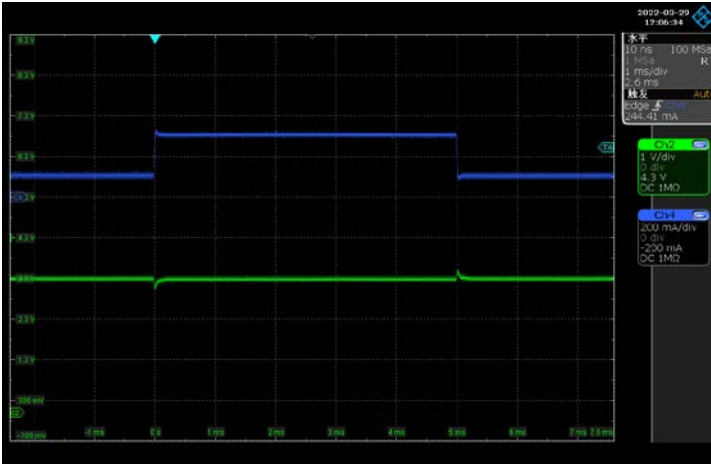

#### Short Circuit Protection(SCP)

$V_{IN} = 4.3V$ ,  $V_{OUT}$  short to GND, CH2:  $V_{OUT}$ , CH4:  $I_{OUT}$   
SCP Peak Current

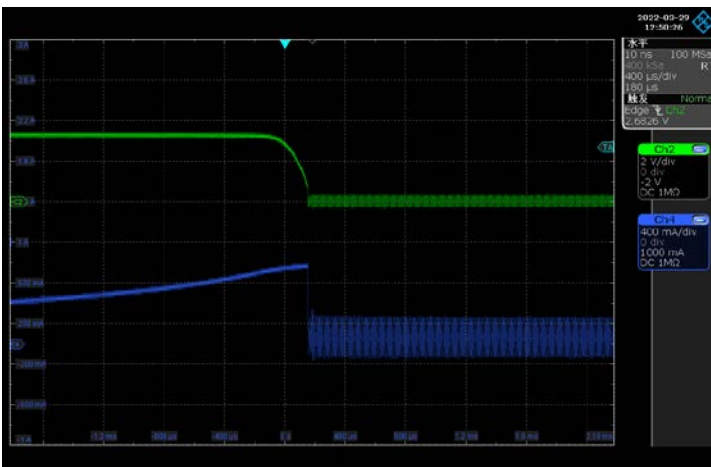

#### SCP Release Current

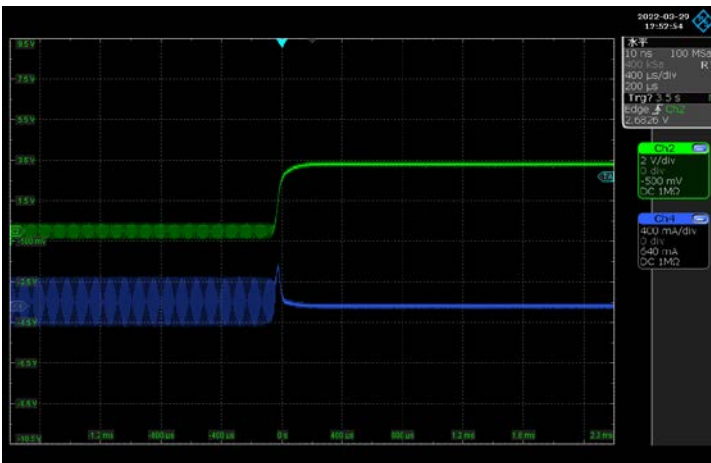

#### SCP Continuous Current

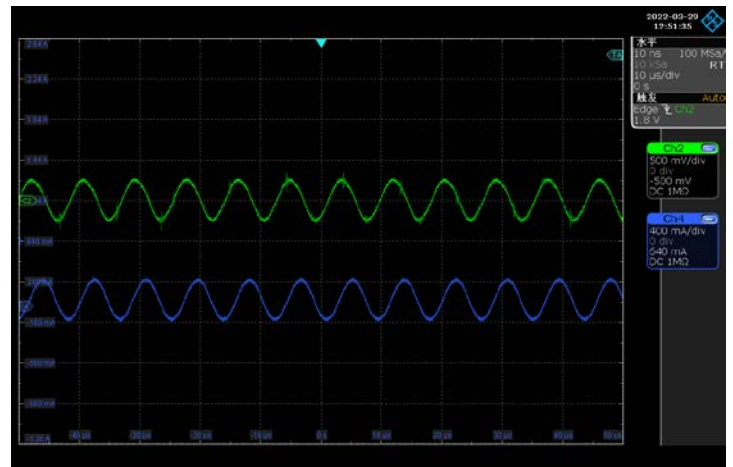

## 6 Specifications

### 6.6 Typical Characteristics(continued)

CJ6101 Series ( $V_{OUT} = 3.3V$ ,  $V_{IN} = V_{OUT} + 1V$ ,  $C_{IN} = 1\mu F$ ,  $C_{OUT} = 1\mu F$ ,  $T_A = 25^\circ C$ , unless otherwise specified)

#### Start-up Time

$V_{EN} = V_{IN}$ ,  $V_{IN} = 0$  to  $4.3V$ ,  $V_{OUT} = 3.3V$ , CH1:  $V_{IN}$ , CH2:  $V_{OUT}$

$I_{OUT} = 0mA$

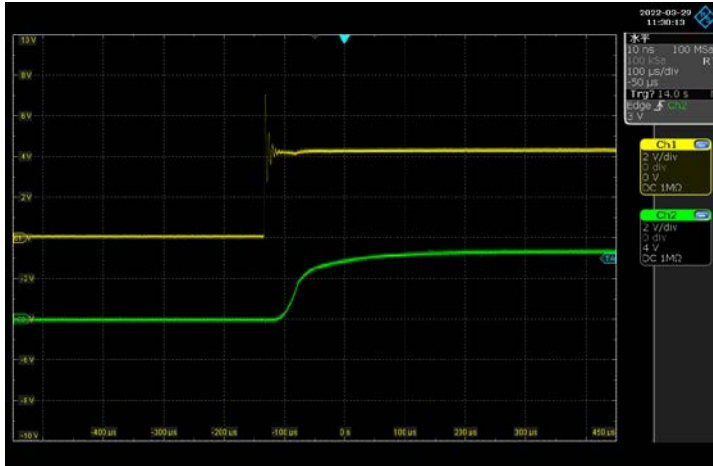

$I_{OUT} = 10mA$

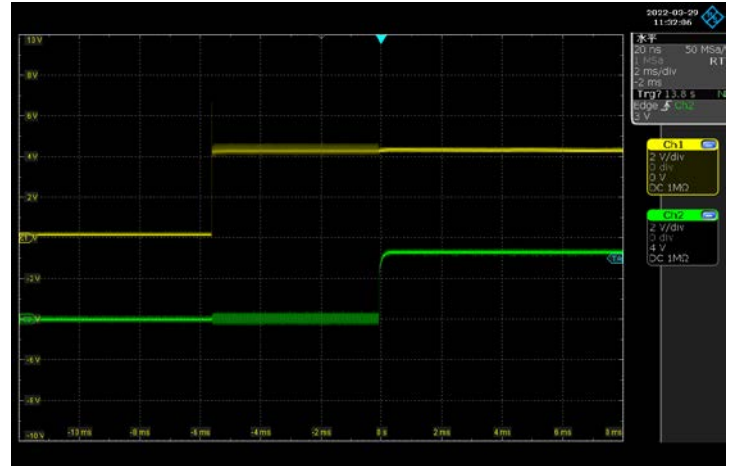

#### EN High & Low

$V_{IN} = 4.3V$ ,  $V_{EN} = 0$  to  $4.3V$ ,  $V_{OUT} = 3.3V$ , CH1:  $V_{EN}$ , CH2:  $V_{OUT}$

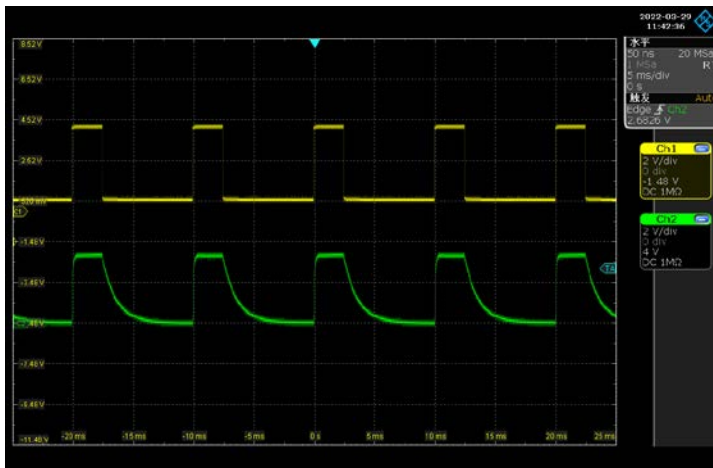

## 7 Detailed Description

### 7.1 Description

The CJ6101 series is a group of linear voltage regulators with ultra-low power consumption and low voltage difference. After optimization, it has excellent transient performance. These features make the device ideal for most battery powered applications. This low dropout linear regulator provides active discharge, short circuit protection and thermal shutdown protection functions.

### 7.2 Functional Block Diagram

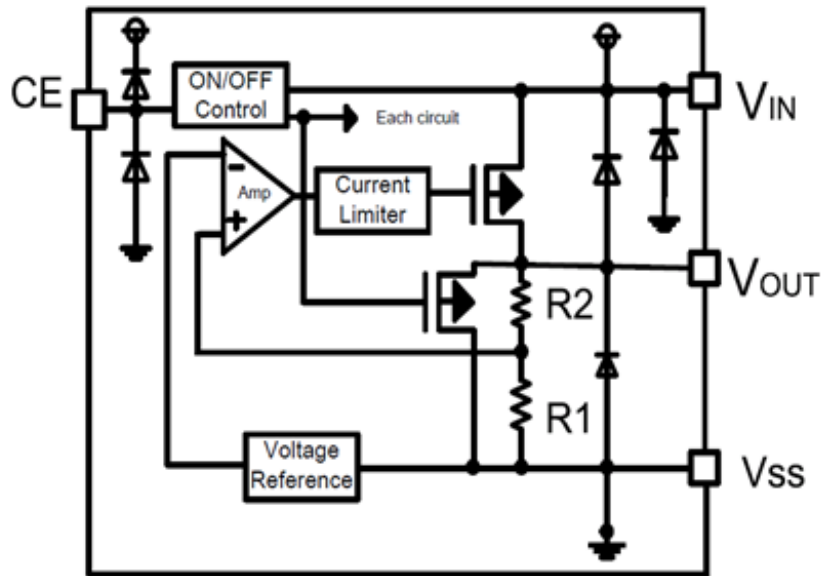

### 7.3 Feature Description

#### Input Voltage

When the input voltage is lower than the rated range of the data sheet, the equipment will lose the regulation function of stabilizing the output voltage, that is, it is unable to maintain the output voltage within the rated range. At this time, compared with normal operation, the quiescent current of the equipment may exceed the rated range, and the transient response performance of the equipment may be seriously degraded. When the input voltage is higher than the rated range of the data sheet, the equipment may cause irreversible damage or failure due to exceeding the maximum rated range of electrical stress.

#### Enable Shutdown

When the EN is at a Low level, the device will be switched off, the output voltage will drop to 0V(Typ.) within a certain period of time. When the EN is at a High level, the device will be switched on, the output voltage will rise to the normal output state within a certain period of time. The High and Low voltage of EN can be viewed in *Electrical Characteristics*. When EN control function is not used, EN can be connected to INPUT.

---

## 7 Detailed Description

---

### 7.3 Feature Description(continued)

#### Output Current

When the circuit design is appropriate, the CJ6101 series can reach the maximum load capacity of at least 300mA. According to the heat dissipation power consumption of the package and the effective connection thermal resistance with the environment, selecting the appropriate package for the circuit design can make the product emit more heat energy.

#### Thermal Shutdown

The CJ6101 series has thermal shutdown protection mechanism. When the junction temperature exceeds the rated temperature range for normal operation in the data sheet, the equipment will enter the thermal shutdown state. At this time, the output voltage of the equipment will be reduced to prevent catastrophic damage to the chip due to accidental heat. The temperature of the device entering the thermal shutdown state ( $T_{SD}$ ) and the temperature recovered from the thermal shutdown state ( $\Delta T_{SD}$ ) can be found in *Electrical Characteristics*.

To ensure reliable operation, please limit the junction temperature to the specified range of *Recommended Operating Conditions* in the data sheet. Applications that exceed the recommended temperature range may cause the equipment to exceed its operating specifications. Although the internal protection circuitry of the device is designed to protect against thermal overall conditions, this circuitry is not intended to replace proper heat sinking. Continuously running the device into thermal shutdown or above the maximum recommended junction temperature reduces long-term reliability.

#### Short Circuit Protection

The CJ6101 series has short circuit protection mechanism. If the out pin of the regulator is short circuited, the built-in short circuit protection of the regulator will maintain the output current at a relatively small value to protect the device. When the short circuit protection mechanism is triggered, the typical value of short circuit current at this time is 100mA, and the output voltage is not regulated.

#### Auto-discharge Function

The device has an automatic discharge mechanism. When the enabling control of the device is turned off, a pull-down MOSFET inside the device (see *Functional Block Diagram*) will connect a resistor to the ground to release the charge in the output capacitor, so as to turn off the whole device circuit. Refer to *Electrical Characteristics* for the value of automatic discharge resistance ( $R_{Discharge}$ ).

Do not rely on the active discharge circuit for discharging a large amount of output capacitance after the input supply has collapsed because reverse current can possibly flow from the output to the input. This reverse current flow can cause damage to the device. Limit reverse current to no more than 5% of the device rated current for a short period of time.



## 8 Application and Implementation

### 8.1 Typical Application Circuit

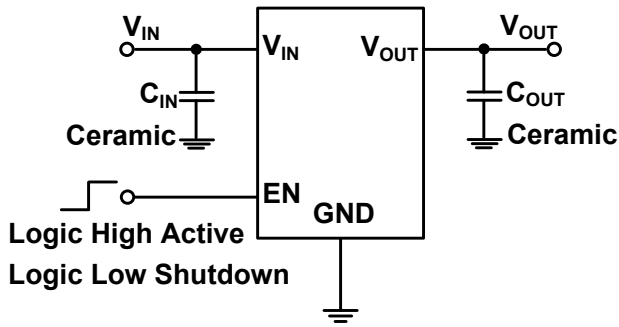

Figure 8-1. Fixed Output Voltage Regulator

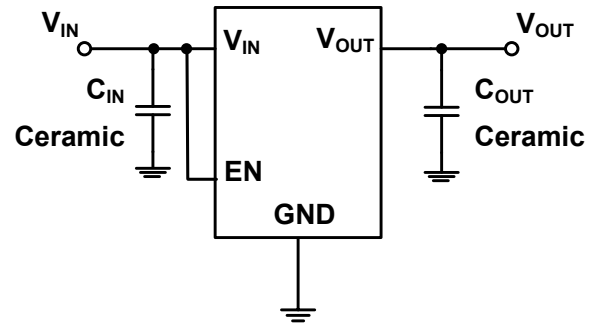

Figure 8-2. DC Parameters Test Circuit

### 8.2 Transient Response

Transient response refers to the change of system output from initial state to stable state under the action of a typical signal input. For LDO, designers should pay attention to the possible effects of linear transient response and load transient response on the system: linear transient response refers to the transient response of the output to changes when the input voltage changes, and load transient response refers to the transient response of the output to changes when the output current changes. The specific phenomenon is that the output voltage of the device will have a short spike, especially when the input voltage or output current changes a large amount in a short time. This change is related not only to the performance of the chip itself, but also to the output current variation, the rate of change, and the output capacitance:

1. when the output current increases, the output voltage of the device will decrease to a certain extent, which will affect the transient spike phenomenon and reduce the spike;
2. The output current or input voltage changes relatively slowly, and the output of the device changes relatively less dramatically, affecting the spikes caused by the changes;
3. Using a large output capacitance can reduce the spike generated by the transient response to improve the transient performance, but it also has an impact on the response time of the device.

For the selection of bypass capacitance values, please see the part *Bypass Capacitance Selection*.

---

## 8 Application and Implementation

---

### 8.3 Bypass Capacitance Selection

It is recommended to use 1 $\mu$ F input and output ceramic capacitors to keep the equipment stable, and the position of the capacitor should be as close to the pin of the chip as possible.

Ceramic capacitors with low equivalent series resistance (ESR) are recommended. In such application scenarios, chip multilayer ceramic capacitor (MLCC) is a good choice, but the appropriate type of capacitor must be selected. Ceramic capacitors with X7R, X5R and C0G rated dielectric materials can provide relatively good capacitance stability for the equipment in the temperature range. However, due to the large change of Y5V capacitance value, Y5V capacitor is not recommended. However, no matter which kind of ceramic capacitor is selected, the effective capacitance may vary with the working voltage and temperature.

In general, the use of appropriate input capacitors can help offset reactive input sources and improve transient response, input ripple and PSRR. If the power impedance is greater than 0.5  $\Omega$ , it is recommended to use input capacitors. Higher value capacitors may be required if large, fast rise time load or line transients are expected, or if the equipment is located a few inches from the input power supply.

Also, the dynamic performance of the device can be improved by using a suitable output capacitor.

#### NOTE

The application information in this section is not part of the data sheet component specification, and JSCJ makes no commitment or statement to guarantee its accuracy or completeness. Customers are responsible for determining the rationality of corresponding components in their circuit design and making tests and verifications to ensure the normal realization of their circuit design.



## 9 Packaging Information

### 9.1 SOT-23-3L Package

#### SOT-23-3L Outlines Dimensions

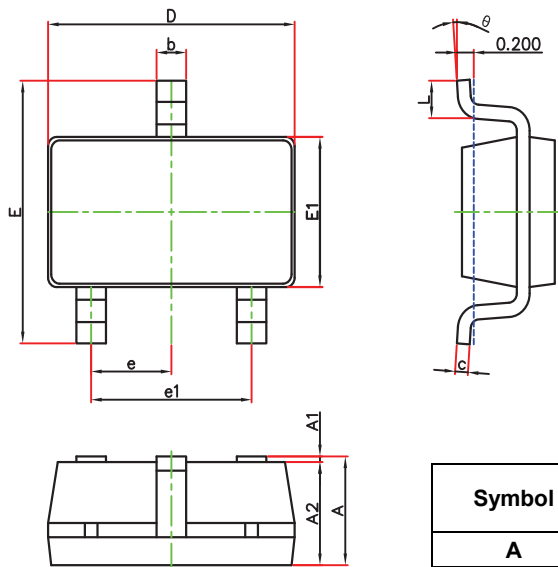

Symbol	Dimensions In Millimeters		Dimensions In Inches	
	Min.	Max.	Min.	Max.
A	1.050	1.250	0.041	0.049
A1	0.000	0.100	0.000	0.004
A2	1.050	1.150	0.041	0.045
b	0.300	0.500	0.012	0.020
c	0.100	0.200	0.004	0.008
D	2.820	3.020	0.111	0.119
E	2.650	2.950	0.104	0.116
E1	1.500	1.700	0.059	0.067
e	0.950(BSC)		0.037(BSC)	
e1	1.800	2.000	0.071	0.079
L	0.300	0.600	0.012	0.024
$\theta$	0°	8°	0°	8°

#### SOT-23-3L Suggested Pad Layout

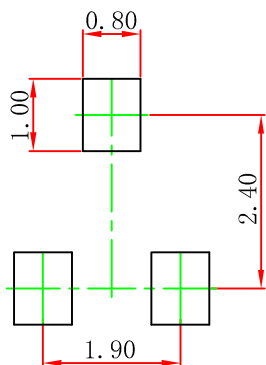

#### Note:

1. Controlling dimension: in millimeters.
2. General tolerance:  $\pm 0.05$ mm.
3. The pad layout is for reference purpose only.

## 9 Packaging Information

### 9.2 SOT-23-5L Package

#### SOT-23-5L Outlines Dimensions

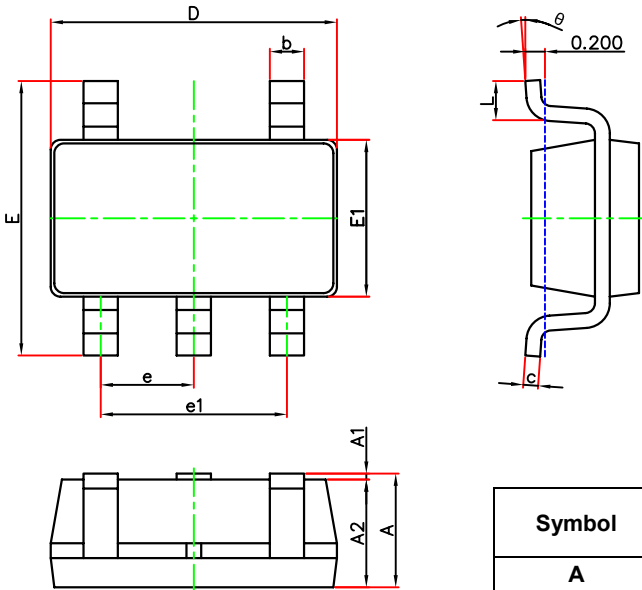

Symbol	Dimensions In Millimeters		Dimensions In Inches	
	Min.	Max.	Min.	Max.
A	1.050	1.250	0.041	0.049
A1	0.000	0.100	0.000	0.004
A2	1.050	1.150	0.041	0.045
b	0.300	0.500	0.012	0.020
c	0.100	0.200	0.004	0.008
D	2.820	3.020	0.111	0.119
E	2.650	2.950	0.104	0.116
E1	1.500	1.700	0.059	0.067
e	0.950(BSC)		0.037(BSC)	
e1	1.800	2.000	0.071	0.079
L	0.300	0.600	0.012	0.024
θ	0°	8°	0°	8°

#### SOT-23-5L Suggested Pad Layout

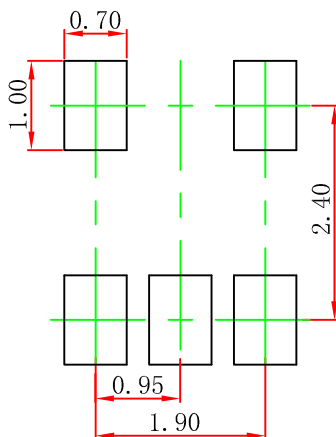

Note:

1. Controlling dimension: in millimeters.
2. General tolerance:  $\pm 0.05\text{mm}$ .
3. The pad layout is for reference purpose only.

## 9 Packaging Information

### 9.3 SOT-89-3L Package

#### SOT-89-3L Outlines Dimensions

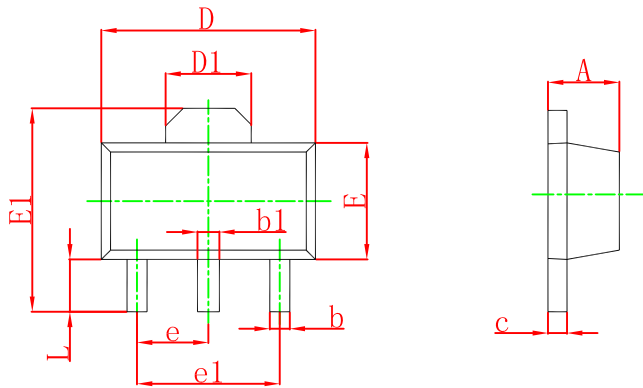

Symbol	Dimensions In Millimeters		Dimensions In Inches	
	Min.	Max.	Min.	Max.
A	1.400	1.600	0.055	0.063
b	0.320	0.520	0.013	0.197
b1	0.400	0.580	0.016	0.023
c	0.350	0.440	0.014	0.017
D	4.400	4.600	0.173	0.181
D1	1.550 REF		0.061 REF	
E	2.300	2.600	0.091	0.102
E1	3.940	4.250	0.155	0.167
e	1.500 TYP		0.060 TYP	
e1	3.000 TYP		0.118 TYP	
L	0.900	1.200	0.035	0.047

#### SOT-89-3L Suggested Pad Layout

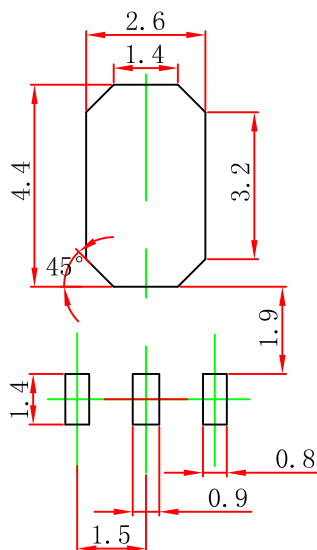

#### Note:

1. Controlling dimension: in millimeters.
2. General tolerance:  $\pm 0.05\text{mm}$ .
3. The pad layout is for reference purpose only.

## 9 Packaging Information

### 9.4 DFNWB1×1-4L Package

#### DFNWB1×1-4L Outlines Dimensions

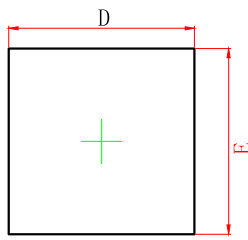

TOP VIEW

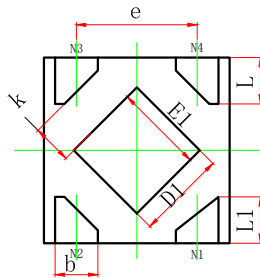

BOTTOM VIEW

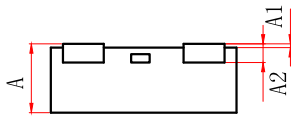

SIDE VIEW

Symbol	Dimensions In Millimeters		Dimensions In Inches	
	Min.	Max.	Min.	Max.
<b>A</b>	<b>0.320</b>	<b>0.400</b>	<b>0.013</b>	<b>0.016</b>
<b>A1</b>	<b>0.000</b>	<b>0.050</b>	<b>0.000</b>	<b>0.002</b>
<b>A2</b>	<b>0.100 REF.</b>		<b>0.004 REF.</b>	
<b>D</b>	<b>0.950</b>	<b>1.050</b>	<b>0.037</b>	<b>0.041</b>
<b>E</b>	<b>0.950</b>	<b>1.050</b>	<b>0.037</b>	<b>0.041</b>
<b>D1</b>	<b>0.430</b>	<b>0.530</b>	<b>0.017</b>	<b>0.021</b>
<b>E1</b>	<b>0.430</b>	<b>0.530</b>	<b>0.017</b>	<b>0.021</b>
<b>k</b>	<b>0.150MIN.</b>		<b>0.006MIN.</b>	
<b>b</b>	<b>0.180</b>	<b>0.280</b>	<b>0.007</b>	<b>0.011</b>
<b>e</b>	<b>0.650TYP.</b>		<b>0.026TYP.</b>	
<b>L</b>	<b>0.200</b>	<b>0.300</b>	<b>0.008</b>	<b>0.012</b>
<b>L1</b>	<b>0.200</b>	<b>0.300</b>	<b>0.008</b>	<b>0.012</b>

#### DFNWB1×1-4L Suggested Pad Layout

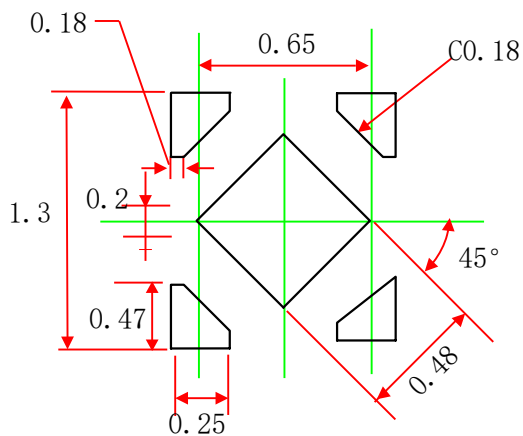

Note:

1. Controlling dimension: in millimeters.
2. General tolerance:  $\pm 0.05\text{mm}$ .
3. The pad layout is for reference purpose only.

---

## 10 Notes and Revision History

---

### 10.1 Associated Product Family and Others

To view other products of the same type or IC products of other types, click the official website of JSCJ -- <https://www.jscj-elec.com> for more details.

### 10.2 Notes

#### Electrostatic Discharge Caution



This IC may be damaged by ESD. Relevant personnel shall comply with correct installation and use specifications to avoid ESD damage to the IC. If appropriate measures are not taken to prevent ESD damage, the hazards caused by ESD include but are not limited to degradation of integrated circuit performance or complete damage of integrated circuit. For some precision integrated circuits, a very small parameter change may cause the whole equipment to be inconsistent with its published specifications.

#### Junction-to-ambient Thermal Resistance $R_{\Theta JA}$

Definition: The junction to ambient thermal resistance  $R_{\Theta JA}$  is a metric of the thermal performance of IC packages. By comparing the metric of different companies on the same product package, the thermal performance of the product can be roughly estimated in a relative sense.  $R_{\Theta JA}$  is measured under the conditions specified in the corresponding specifications. If the measurement of  $R_{\Theta JA}$  of two products follows different specifications and standards, or although the same specifications and standards are adopted, it is not tested in strict accordance with the specifications, then the  $R_{\Theta JA}$  of two products will lose the meaning of comparison. This product follows the test specified by JEDEC in the EIA/JESD51-x series documents.  $R_{\Theta JA}$  is measured in still air with  $T_A = 25^\circ\text{C}$  and installed on a 1 in 2 FR-4 board covered with 2 ounces of copper.

Usage: Junction to ambient thermal resistance  $R_{\Theta JA}$  is a parameter defined at the system level rather than on a single device or chip. In the test of  $R_{\Theta JA}$  provided in the data sheet, most of the heat generated by the operation of the equipment is dissipated through the test board rather than the packaging surface of the equipment. In fact, the design and layout of PCB (such as chip or pad size, internal package geometry, etc.) will significantly affect  $R_{\Theta JA}$ . At this time, any calculation of the junction temperature or thermal power consumption of the device by applying  $R_{\Theta JA}$  in the data sheet will have a very large error, so that it does not match the real performance of the device.

Therefore,  $R_{\Theta JA}$  should be used as the relative comparison of product packaging thermal performance between different companies, rather than directly using  $R_{\Theta JA}$  in the data sheet in the actual calculation.

#### Maximum Power Dissipation for Reference $P_{D \text{ Ref}}$

The maximum power dissipation  $P_{D \text{ Ref}}$  is not an accurate value obtained from the actual test. It is a theoretical value obtained according to the heat dissipation capacity of packaging combined with practical application. It is used to compare the differences of heat dissipation capacity more intuitively between products of different companies. This value is only for estimation reference and cannot be used as an index of the actual performance of the equipment for circuit design.

---

## 10 Notes and Revision History

---

### 10.3 Revision History

June, 2022: changed from rev - 2.1 to rev - 2.2:

Page 2, added the ECO PLAN and MSL into Orderable Information;

Page 3, added the description of the Orderable Information;

Page 8, 9, 10, 11 and 12, added the description of "VOOUT = 3.3V" into "CJ6101 Series".

April, 2022: changed from rev - 2.0 to rev - 2.1:

Page 2, added orderable information;

Page 4, note (4) and (5), changed CJ to JSCJ.

March, 2022: updated CJ6101 series rev - 2.0.

# DISCLAIMER

## **IMPORTANT NOTICE, PLEASE READ CAREFULLY**

The information in this data sheet is intended to describe the operation and characteristics of our products. JSCJ has the right to make any modification, enhancement, improvement, correction or other changes to any content in this data sheet, including but not limited to specification parameters, circuit design and application information, without prior notice.

Any person who purchases or uses JSCJ products for design shall: 1. Select products suitable for circuit application and design; 2. Design, verify and test the rationality of circuit design; 3. Procedures to ensure that the design complies with relevant laws and regulations and the requirements of such laws and regulations. JSCJ makes no warranty or representation as to the accuracy or completeness of the information contained in this data sheet and assumes no responsibility for the application or use of any of the products described in this data sheet.

Without the written consent of JSCJ, this product shall not be used in occasions requiring high quality or high reliability, including but not limited to the following occasions: medical equipment, automotive electronics, military facilities and aerospace. JSCJ shall not be responsible for casualties or property losses caused by abnormal use or application of this product.

Official Website: [www.jscj-elec.com](http://www.jscj-elec.com)

Copyright © JIANGSU CHANGJING ELECTRONICS TECHNOLOGY CO., LTD.

## X-ON Electronics

Largest Supplier of Electrical and Electronic Components

*Click to view similar products for [Linear Voltage Regulators](#) category:*

*Click to view products by [Changjing Electronics Technology](#) manufacturer:*

Other Similar products are found below :

[LV5684PVD-XH](#) [MCDTSA6-2R](#) [L7815ACV-DG](#) [LV56801P-E](#) [UA7805CKC](#) [714954EB](#) [ZMR500QFTA](#) [BA033LBSG2-TR](#)

[NCV78M05ABDTRKG](#) [LV5680P-E](#) [L79M05T-E](#) [L78LR05D-MA-E](#) [NCV317MBTG](#) [NTE7227](#) [MP2018GZD-33-P](#) [MP2018GZD-5-P](#)

[LV5680NPVC-XH](#) [ZTS6538SE](#) [UA78L09CLP](#) [UA78L09CLPR](#) [CAT6221-PPTD-GT3](#) [MC78M09CDTRK](#) [NCV51190MNTAG](#)

[BL1118CS8TR1833](#) [BL8563CKETR18](#) [BL8077CKETR33](#) [BL9153-33CC3TR](#) [BL9161G-15BADRN](#) [BL9161G-28BADRN](#)

[BRCO7530MMC](#) [CJ7815B-TFN-ARG](#) [LM317C](#) [GM7333K](#) [GM7350K](#) [XC6206P332MR](#) [HT7533](#) [LM7912S/TR](#) [LT1764S/TR](#) [LM7805T](#)

[LM338T](#) [LM1117IMP-3.3/TR](#) [HT1117AM-3.3](#) [HT7550S](#) [AMS1117-3.3](#) [HT7150S](#) [78L12](#) [HT7550](#) [HT7533-1](#) [HXY6206I-2.5](#) [HT7133](#)